



US00D671445S

(12) **United States Design Patent**
Paik et al.

(10) **Patent No.:** **US D671,445 S**

(45) **Date of Patent:** **** Nov. 27, 2012**

(54) **FEMALE RECEPTACLE OF BUCKLE**

(76) Inventors: **Jisook Paik**, Seoul (KR); **Nan Hee Paik**, Seoul (KR); **Ji Hye Paik**, Seoul (KR); **Ji Won Son**, Seoul (KR)

(**) Term: **14 Years**

(21) Appl. No.: **29/418,284**

(22) Filed: **Apr. 13, 2012**

(30) **Foreign Application Priority Data**

Mar. 15, 2012 (KR) 30-2012-0012261

(51) **LOC (9) Cl.** **02-07**

(52) **U.S. Cl.** **D11/216**

(58) **Field of Classification Search** D11/1-2,
D11/200-201, 206-210, 214-218; 24/163 R,
24/169-171, 173, 177-179, 191, 194-195,
24/197, 200, 614-616, 625, 198

See application file for complete search history.

(56) **References Cited**

U.S. PATENT DOCUMENTS

D619,496 S * 7/2010 Paik D11/216

D625,226 S * 10/2010 Pontaoe D11/216

* cited by examiner

Primary Examiner — Ralf Seifert

(74) *Attorney, Agent, or Firm* — Allen (Zhi Yang) Xue;
Anova Law Group, PLLC

(57) **CLAIM**

We claim, the ornamental design for a female receptacle of buckle, as shown and described.

DESCRIPTION

FIG. 1 is a perspective view of a female receptacle of buckle, showing my new design;

FIG. 2 is a front elevational view thereof;

FIG. 3 is a rear elevational view thereof;

FIG. 4 is a left side elevational view thereof;

FIG. 5 is a right side elevational view thereof;

FIG. 6 is a top plan view thereof;

FIG. 7 is a bottom plan view thereof;

FIG. 8 is a cross sectional view taken along the line 8-8 of FIG. 2; and,

FIG. 9 is a reference perspective view showing an assembly buckle of a male latch of buckle and a female receptacle of buckle thereof.

The broken line showing of a male buckle portion is included for illustrative purposes only and forms no part of the claimed design.

1 Claim, 3 Drawing Sheets

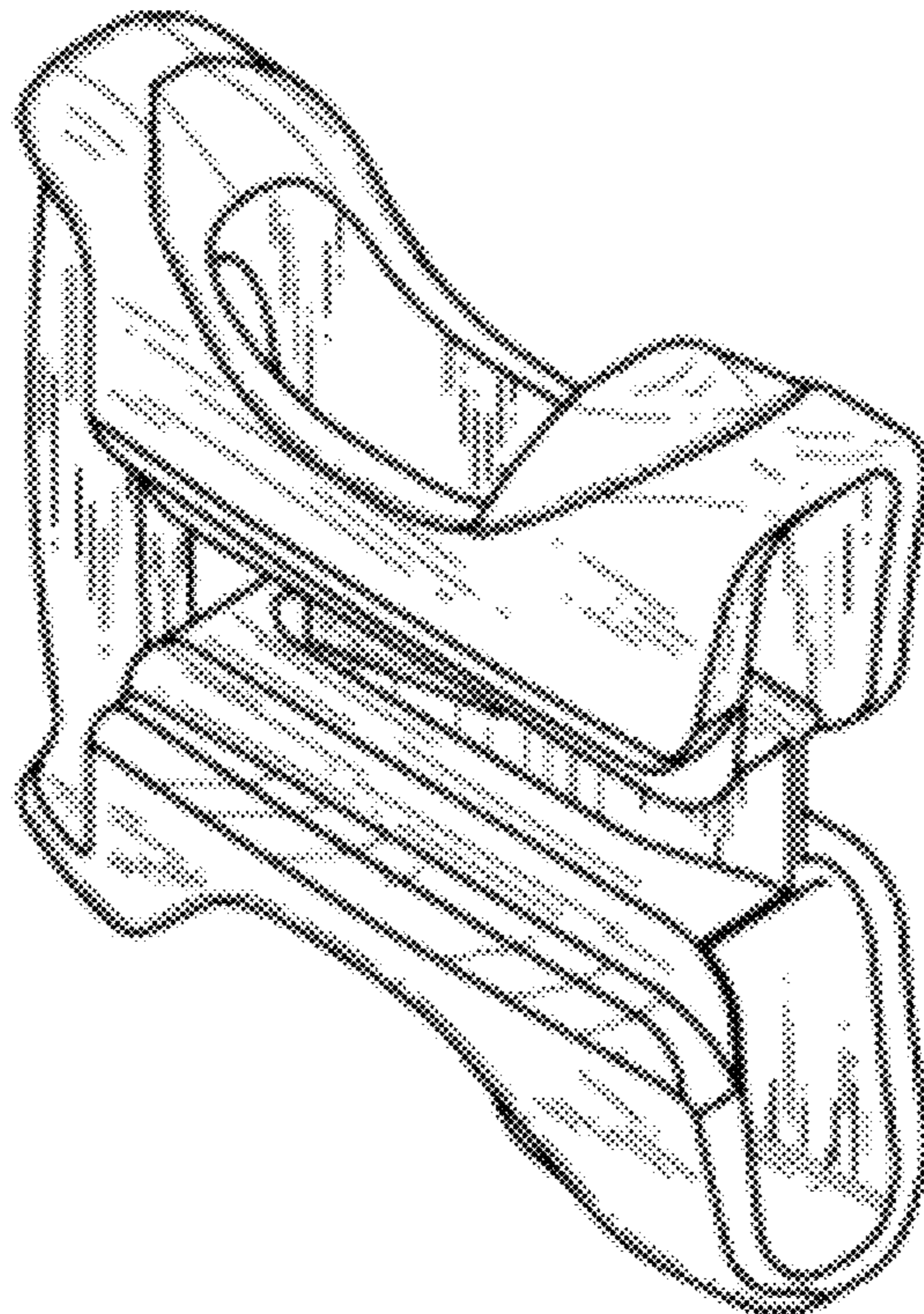

FIG. 1

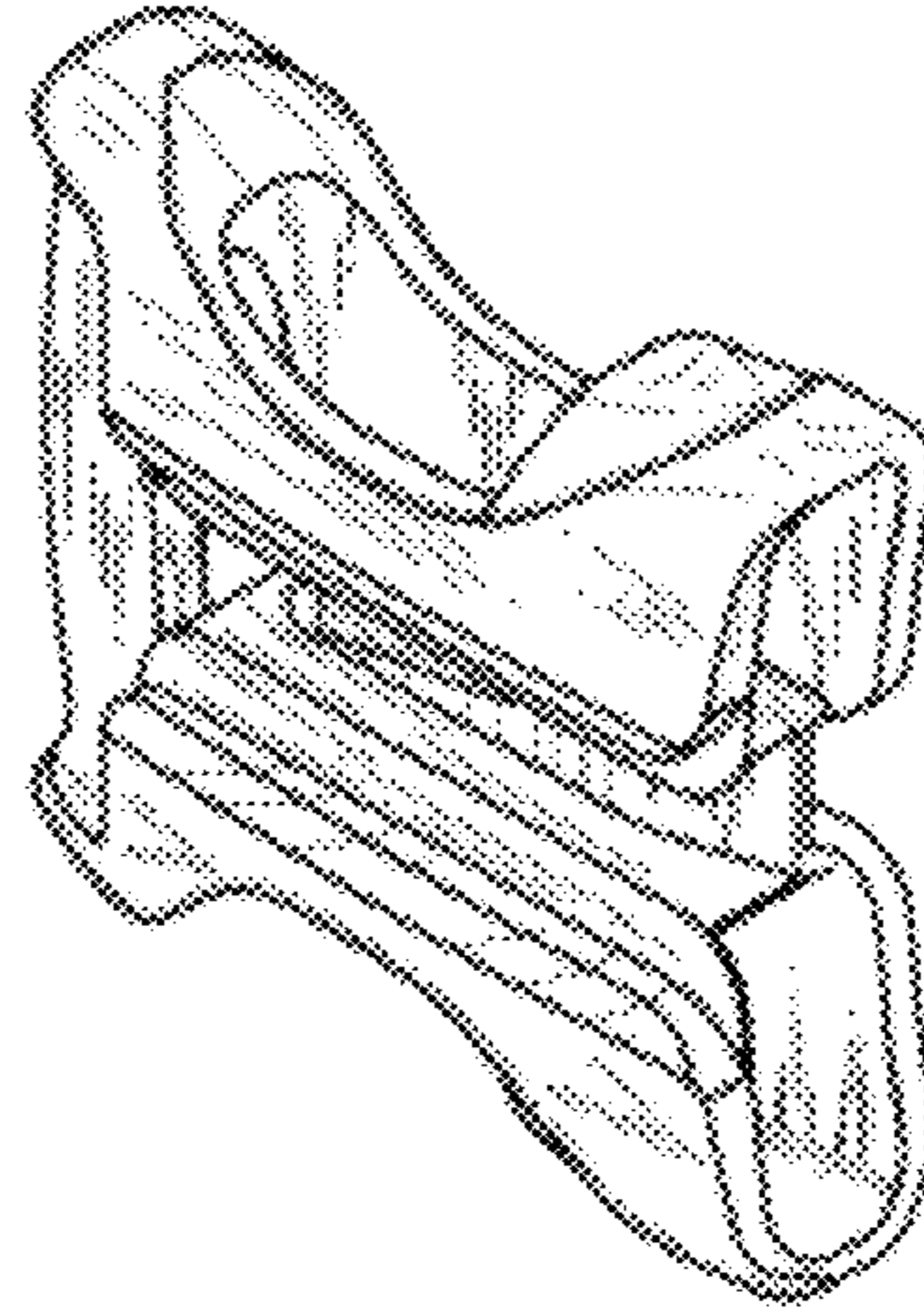

FIG. 2

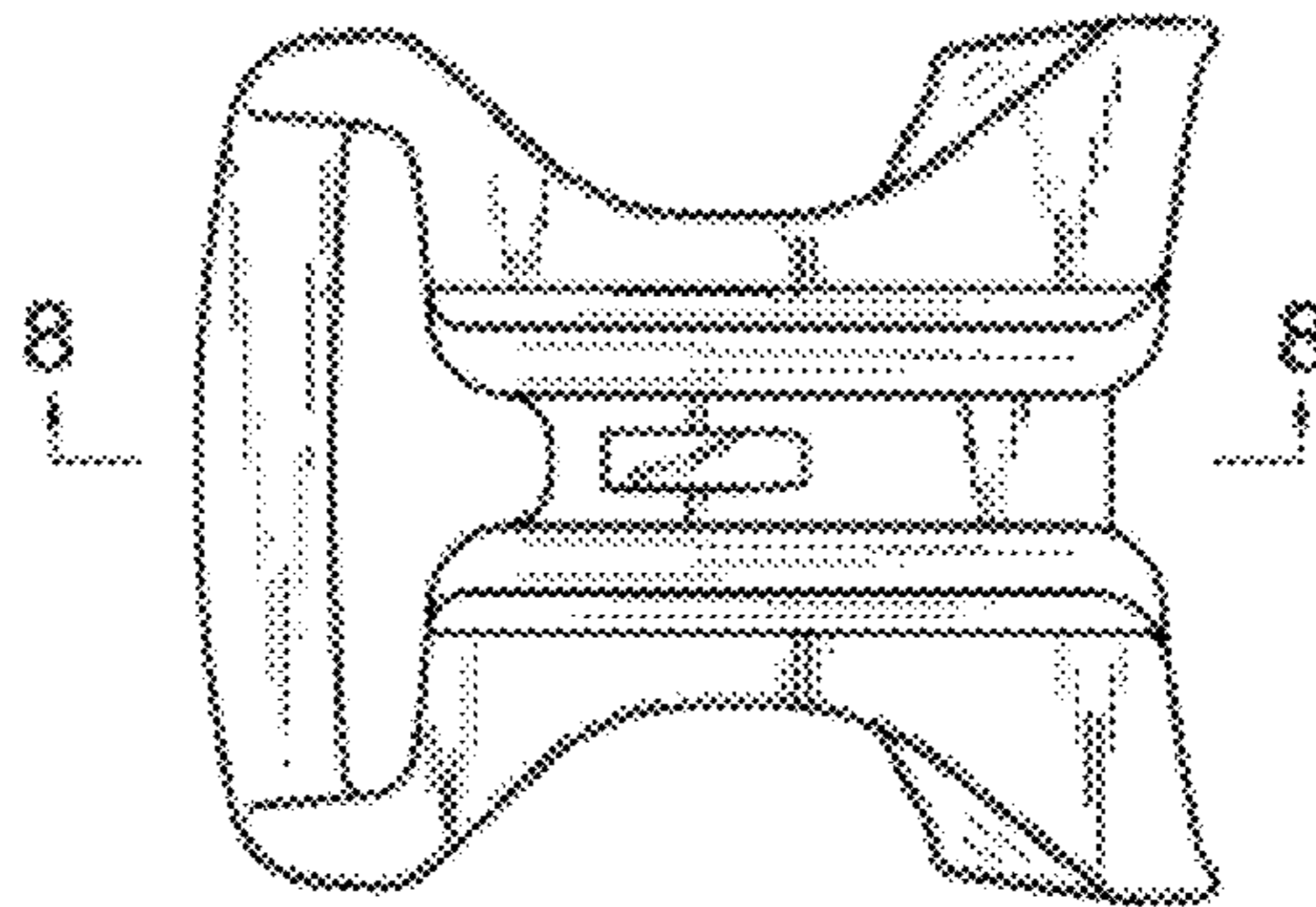

FIG. 3

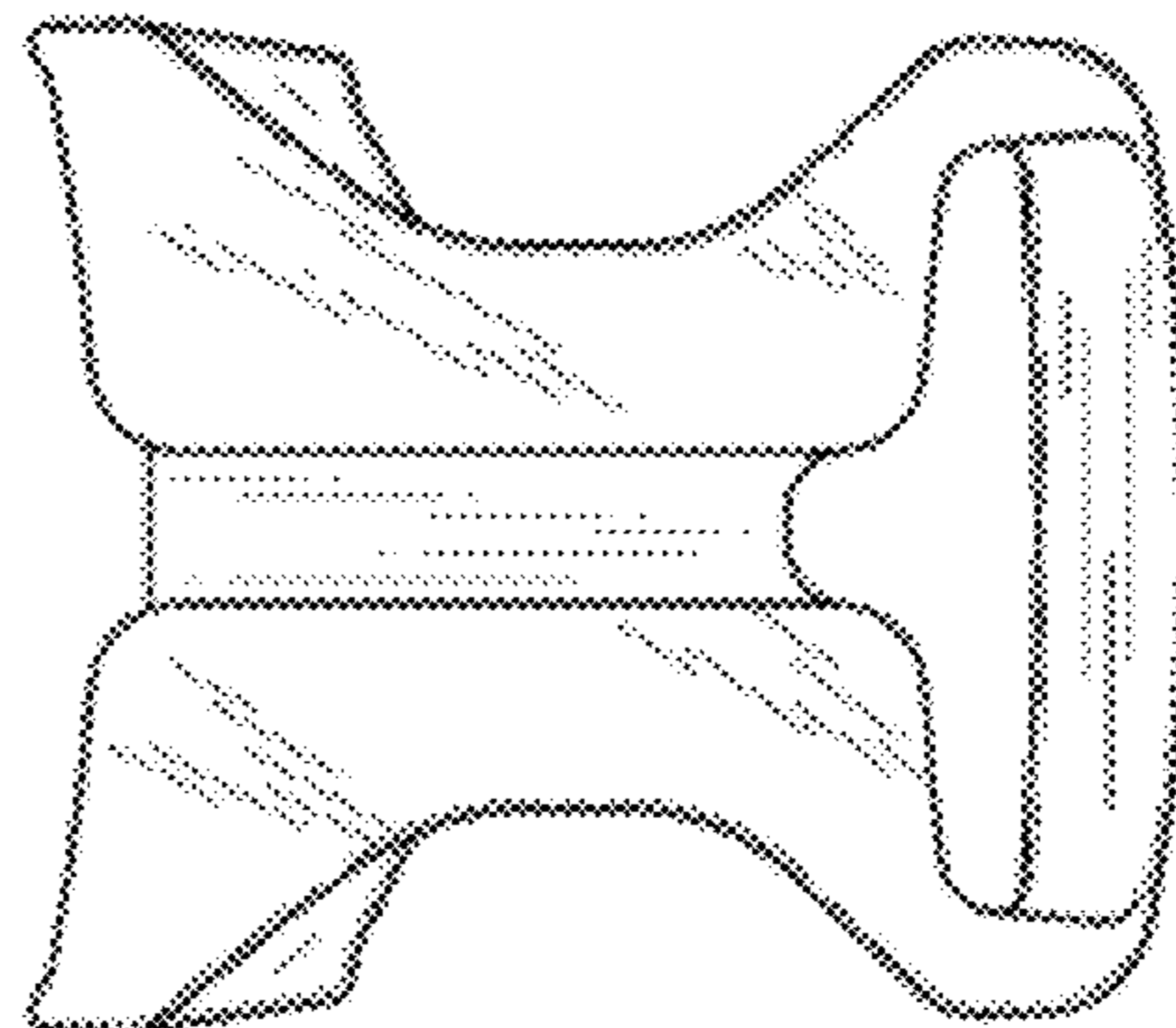

FIG.4

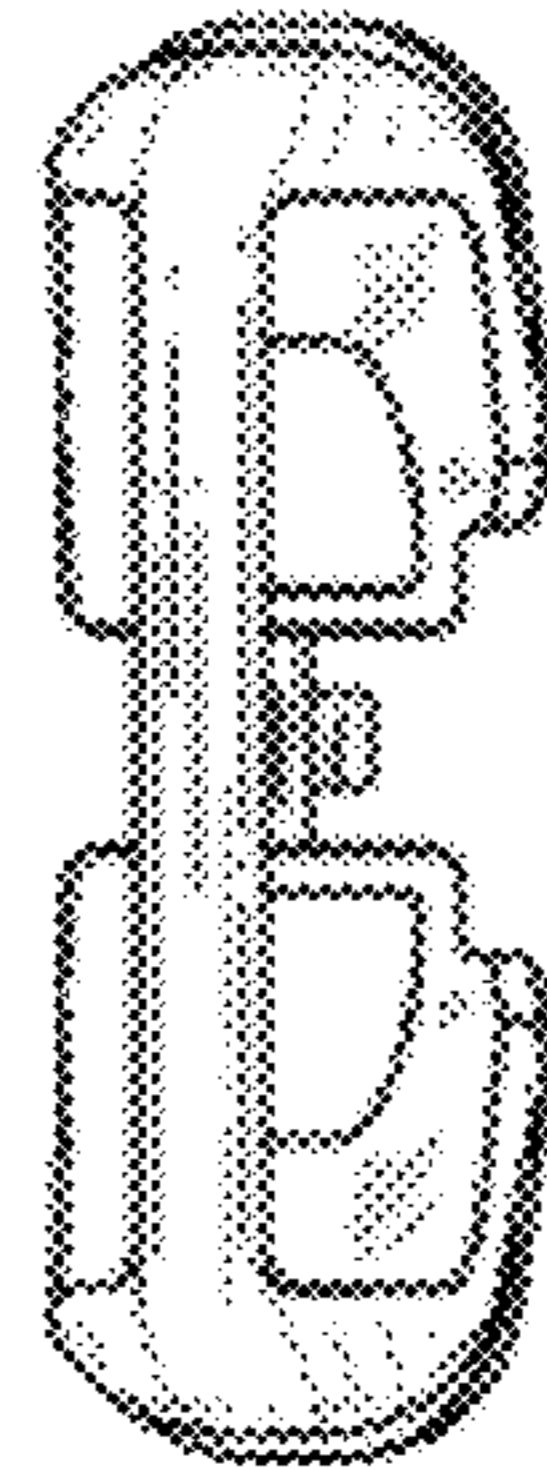

FIG.5

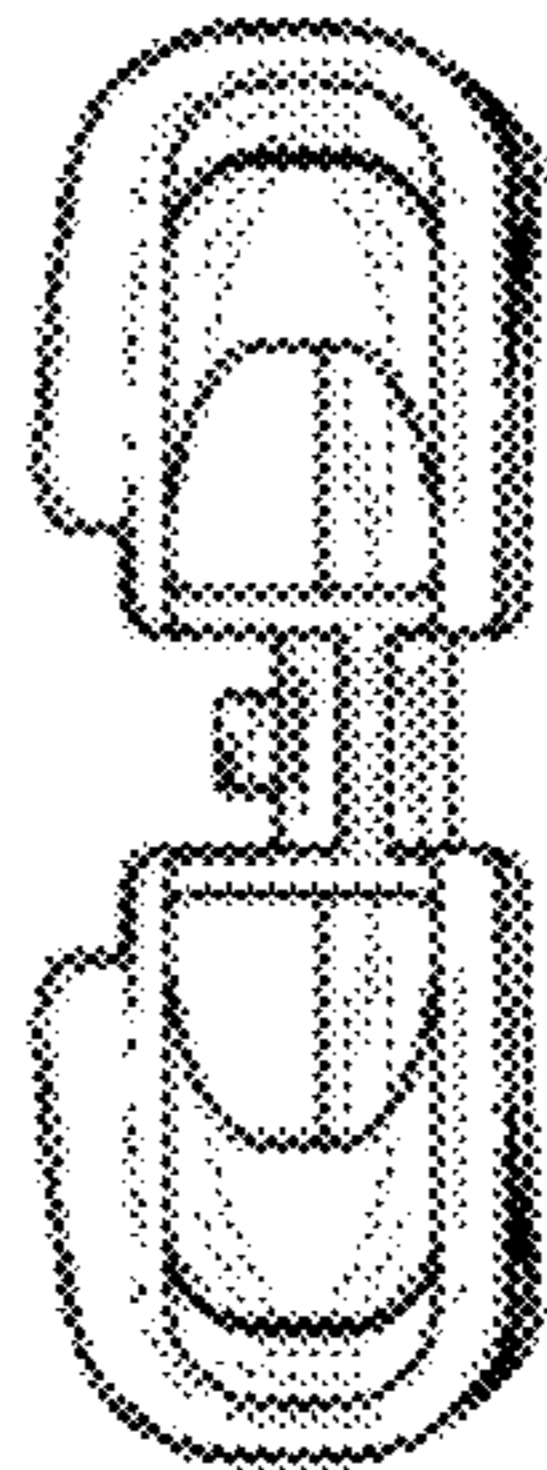

FIG.6

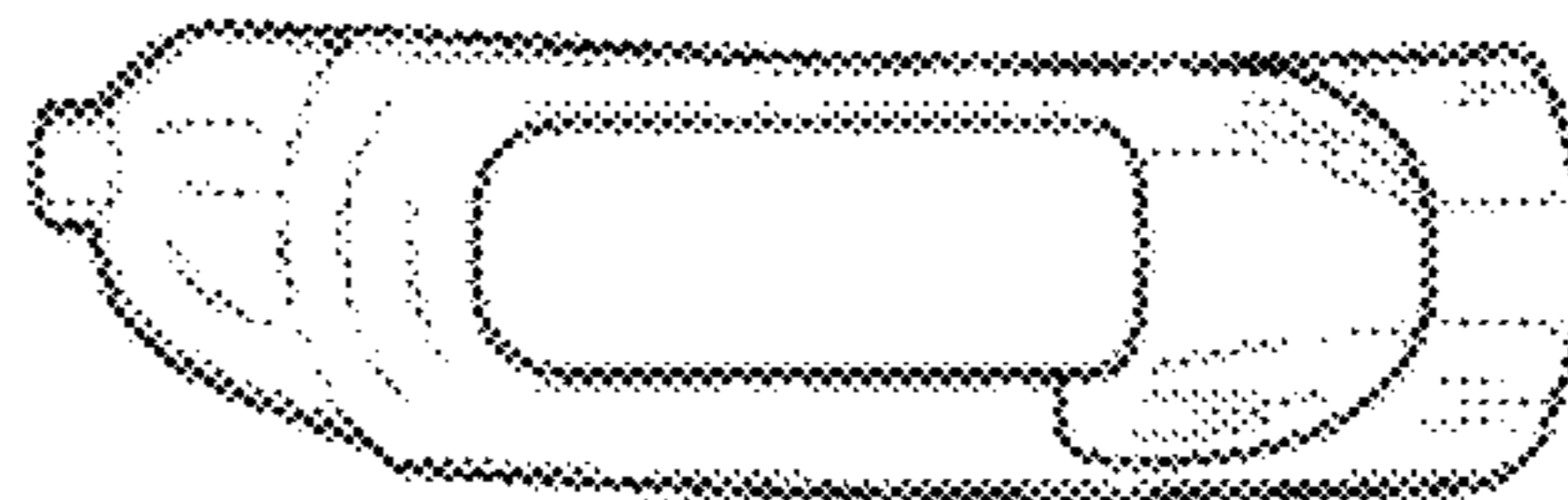

FIG.7

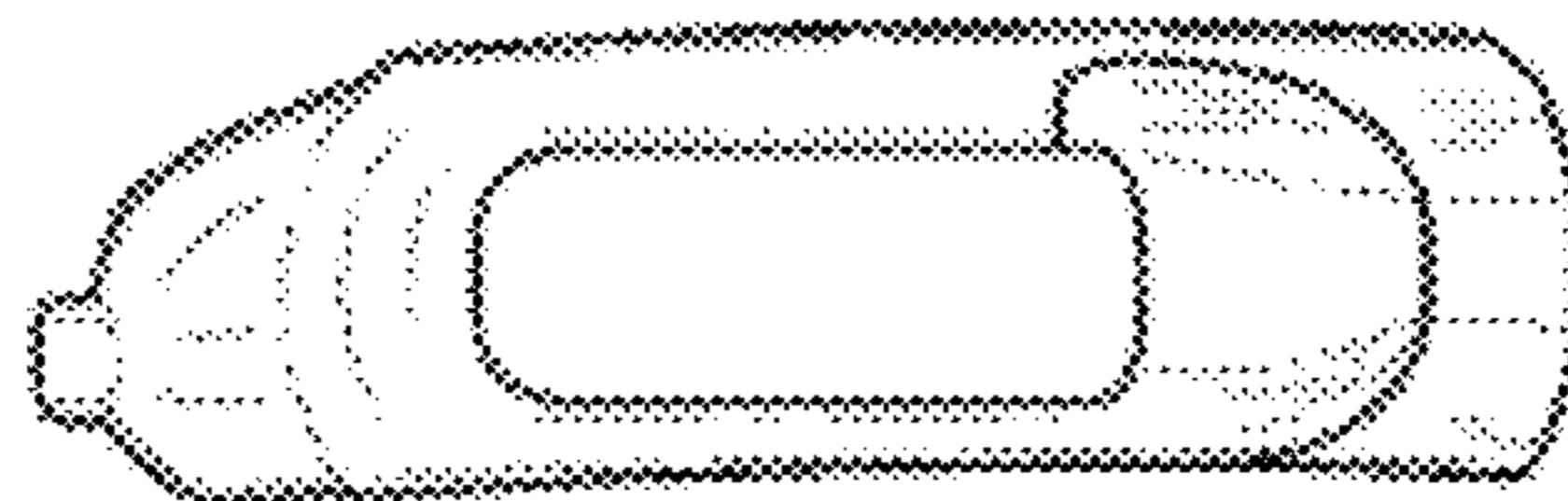

FIG.8

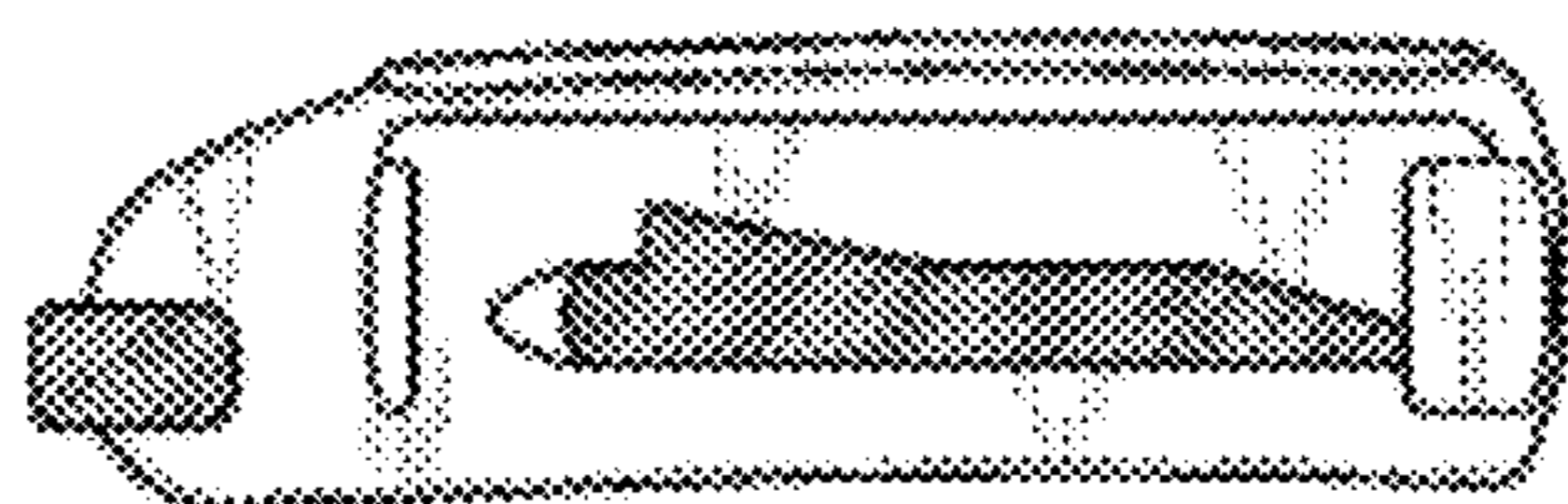

FIG. 9

