



US00D671316S

(12) **United States Design Patent**
Kritzler

(10) **Patent No.:** **US D671,316 S**

(45) **Date of Patent:** **** Nov. 27, 2012**

(54) **CARRY-ON LUGGAGE**

(75) Inventor: **Ronald Kritzler**, Miami, FL (US)

(73) Assignee: **E-Famtrips Inc.**, Miami, FL (US)

(**) Term: **14 Years**

(21) Appl. No.: **29/385,998**

(22) Filed: **Feb. 23, 2011**

(51) **LOC (9) Cl.** **03-01**

(52) **U.S. Cl.** **D3/279; D3/283**

(58) **Field of Classification Search** D3/272,
D3/273, 274, 276, 279, 289, 297, 321, 283;
190/1, 3, 6, 7, 9, 13 R, 14, 13 F, 15.1, 18 A,
190/108, 100-107, 109-114, 115-127, 903
See application file for complete search history.

(56) **References Cited**

U.S. PATENT DOCUMENTS

5,971,119	A *	10/1999	Chi	190/108
6,213,266	B1 *	4/2001	Hollingsworth	190/108
D472,385	S *	4/2003	Bauer	D3/279
D507,876	S *	8/2005	Fadely	D3/279
D632,077	S *	2/2011	Yoder et al.	D3/279
D640,054	S *	6/2011	Custer	D3/274
2002/0148693	A1 *	10/2002	Bauer	190/108
2004/0084269	A1 *	5/2004	Wang	190/108
2008/0093238	A1 *	4/2008	Handelman et al.	190/18 A
2009/0139814	A1 *	6/2009	Grossman et al.	190/18 A
2009/0223765	A1 *	9/2009	Bosma	190/108

* cited by examiner

Primary Examiner — Jennifer Rivard

(74) *Attorney, Agent, or Firm* — Laurence A. Greenberg;
Werner H. Stemer; Ralph E. Locher

(57) **CLAIM**

The ornamental design for carry-on luggage, as shown and described.

DESCRIPTION

FIG. 1 is a front elevational view of the carry-on luggage showing my new design;
FIG. 2 is a rear elevational view thereof;
FIG. 3 is a left side elevational view thereof;
FIG. 4 is a right side elevational view thereof;
FIG. 5 is a top plan view thereof;
FIG. 6 is a bottom plan view thereof;
FIG. 7 is a left side perspective view thereof;
FIG. 8 is an exploded left side perspective view thereof;
FIG. 9 is a front elevational view and is a more generic embodiment thereof;
FIG. 10 is a rear elevational view thereof;
FIG. 11 is a left side elevational view thereof;
FIG. 12 is a right side elevational view thereof;
FIG. 13 is a top plan view thereof;
FIG. 14 is a bottom plan view thereof;
FIG. 15 is a left side perspective view thereof; and,
FIG. 16 is an exploded left side perspective view thereof.
The broken lines are for exemplary illustrative purposes only and form no part of the claimed design.

1 Claim, 16 Drawing Sheets

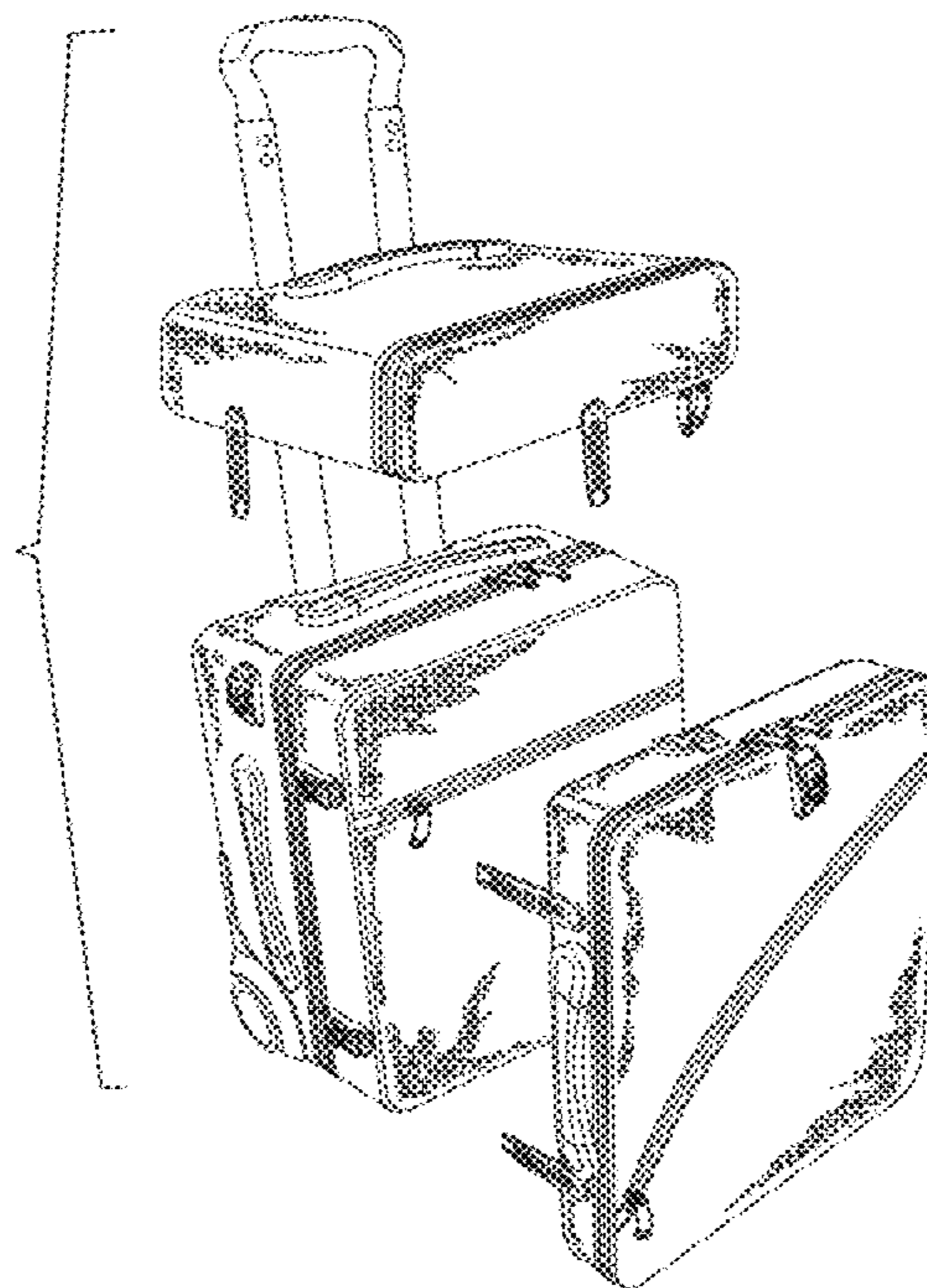
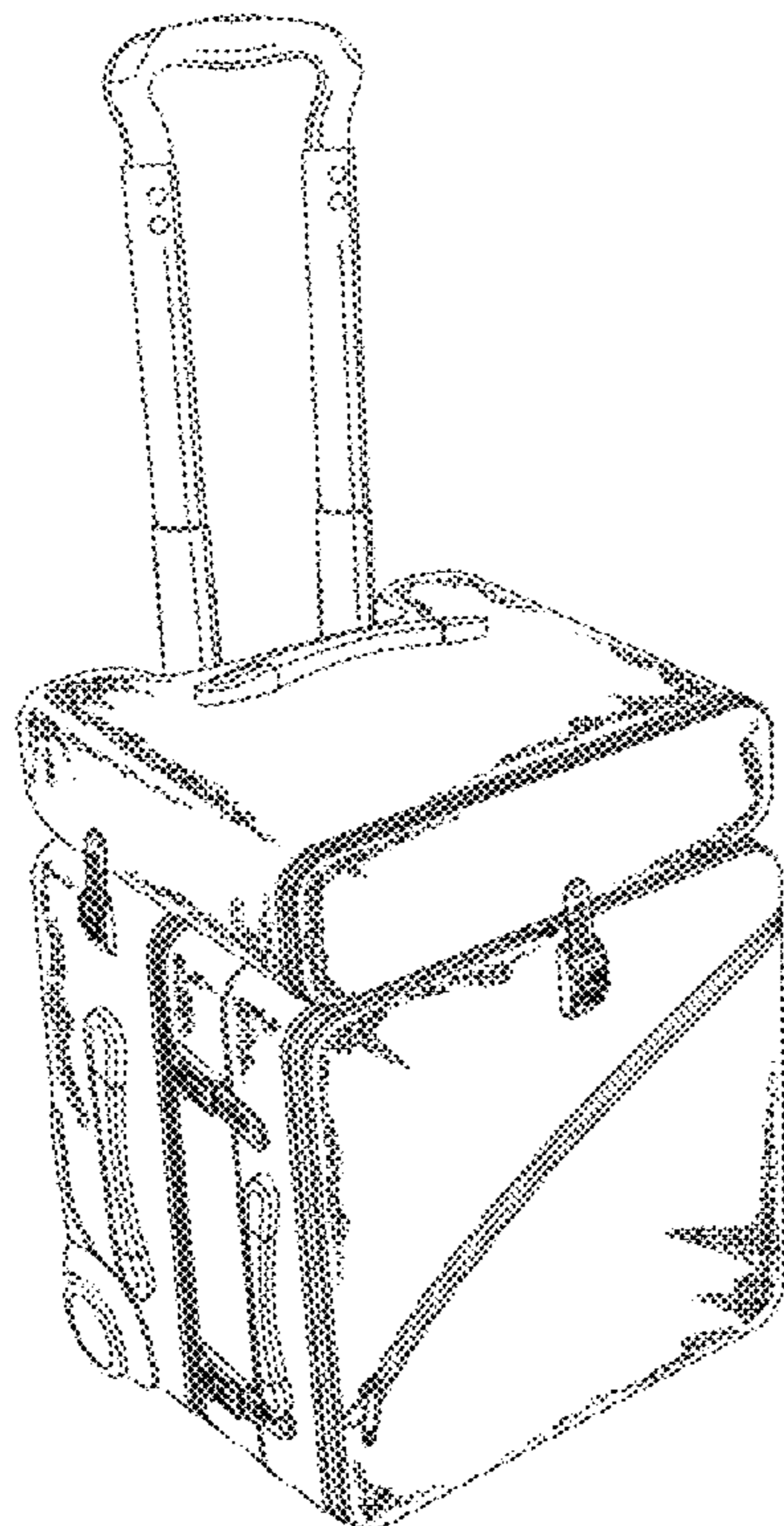

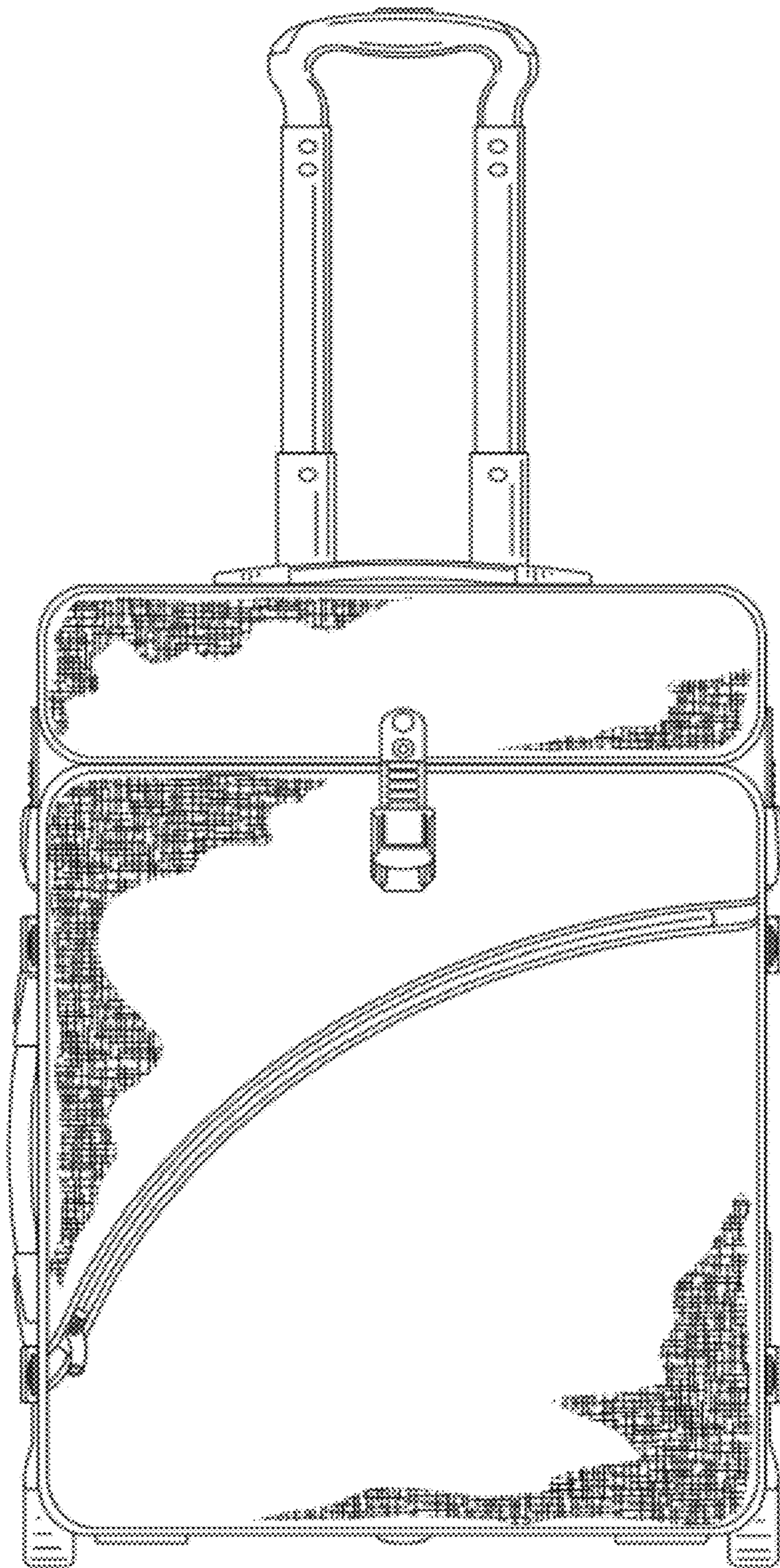

FIG. 1

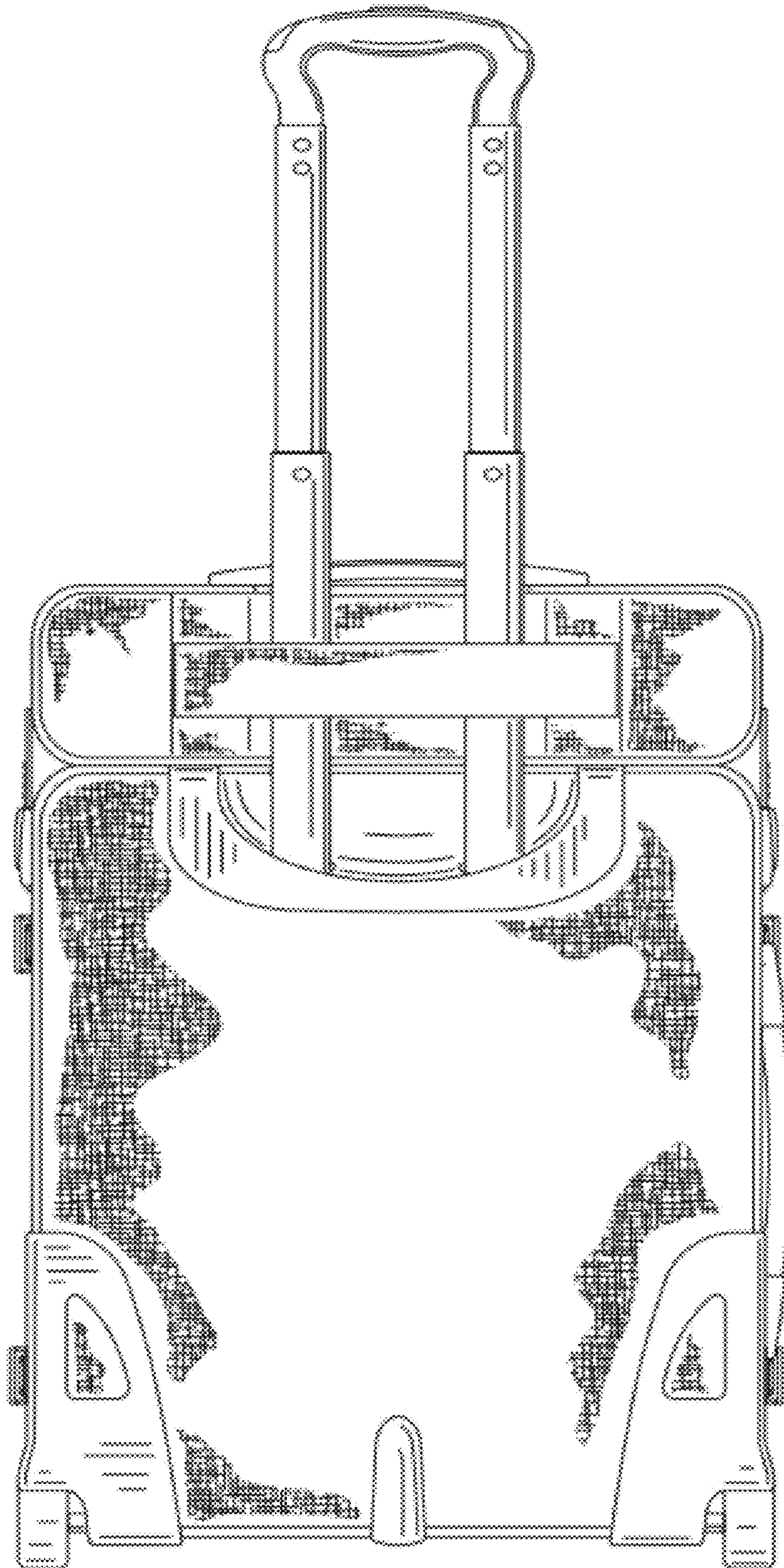

FIG. 2

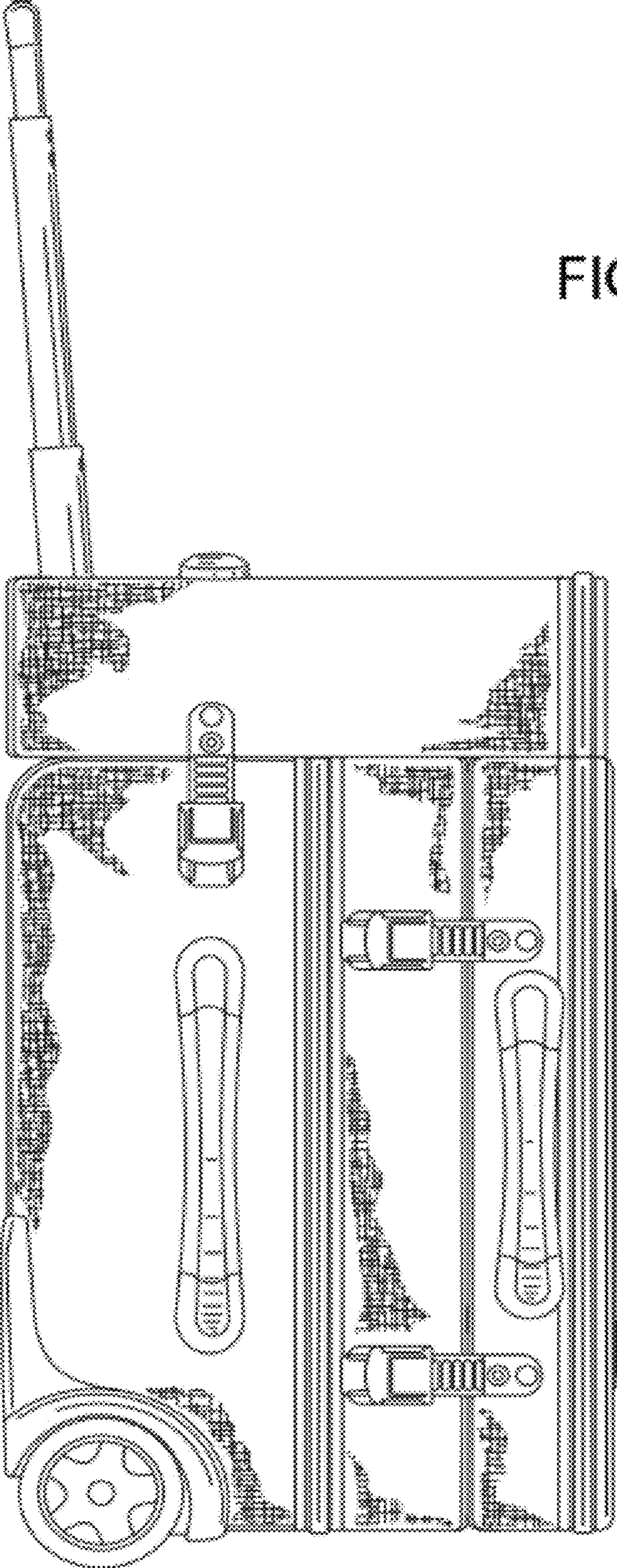
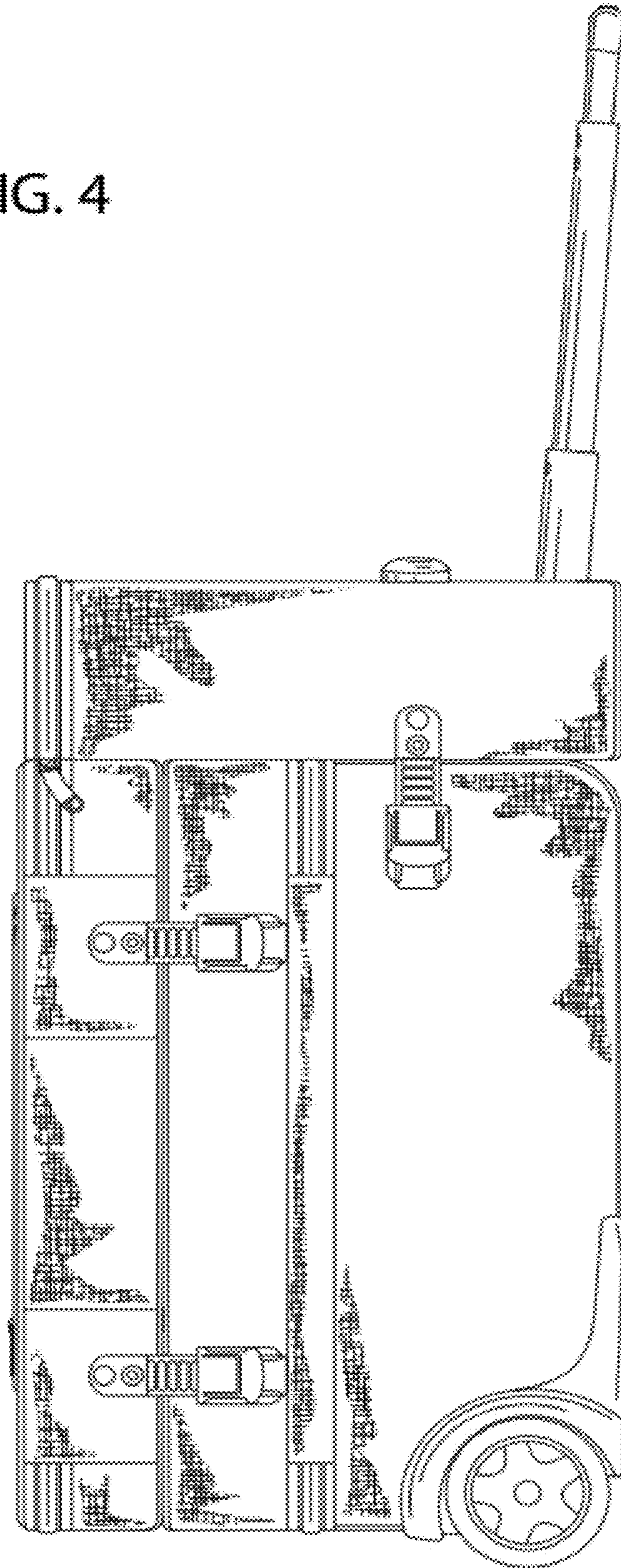

FIG. 3

FIG. 4



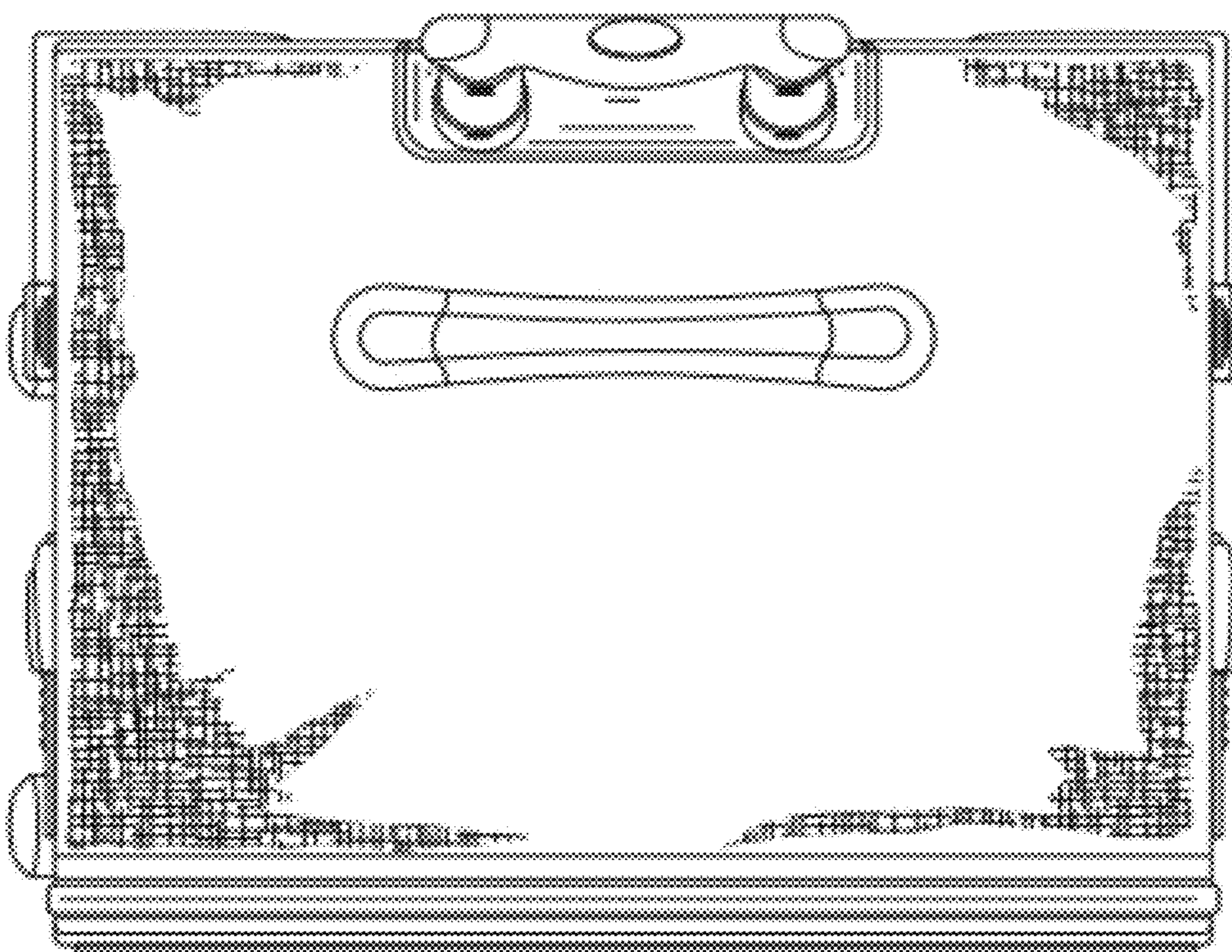

FIG. 5

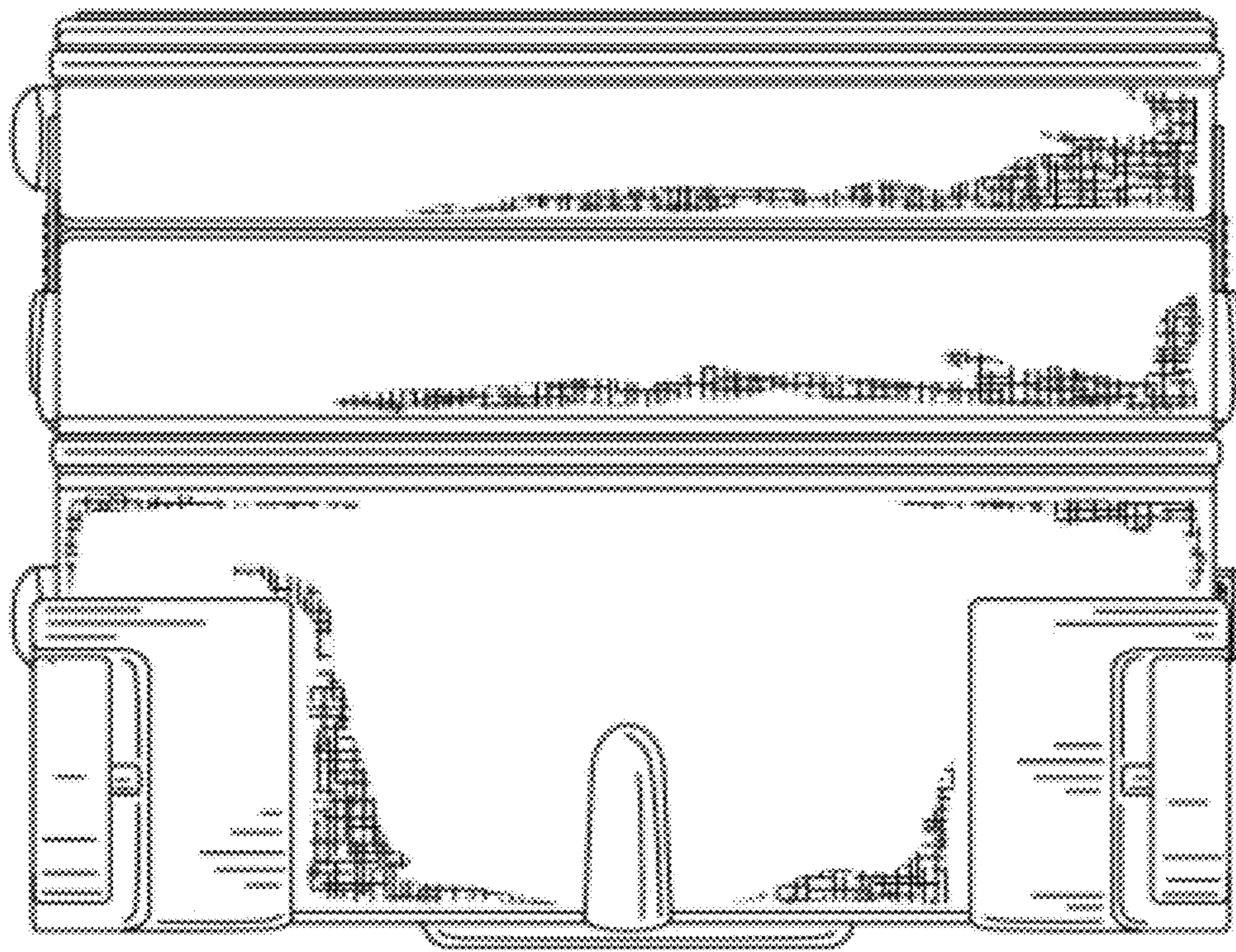

FIG. 6

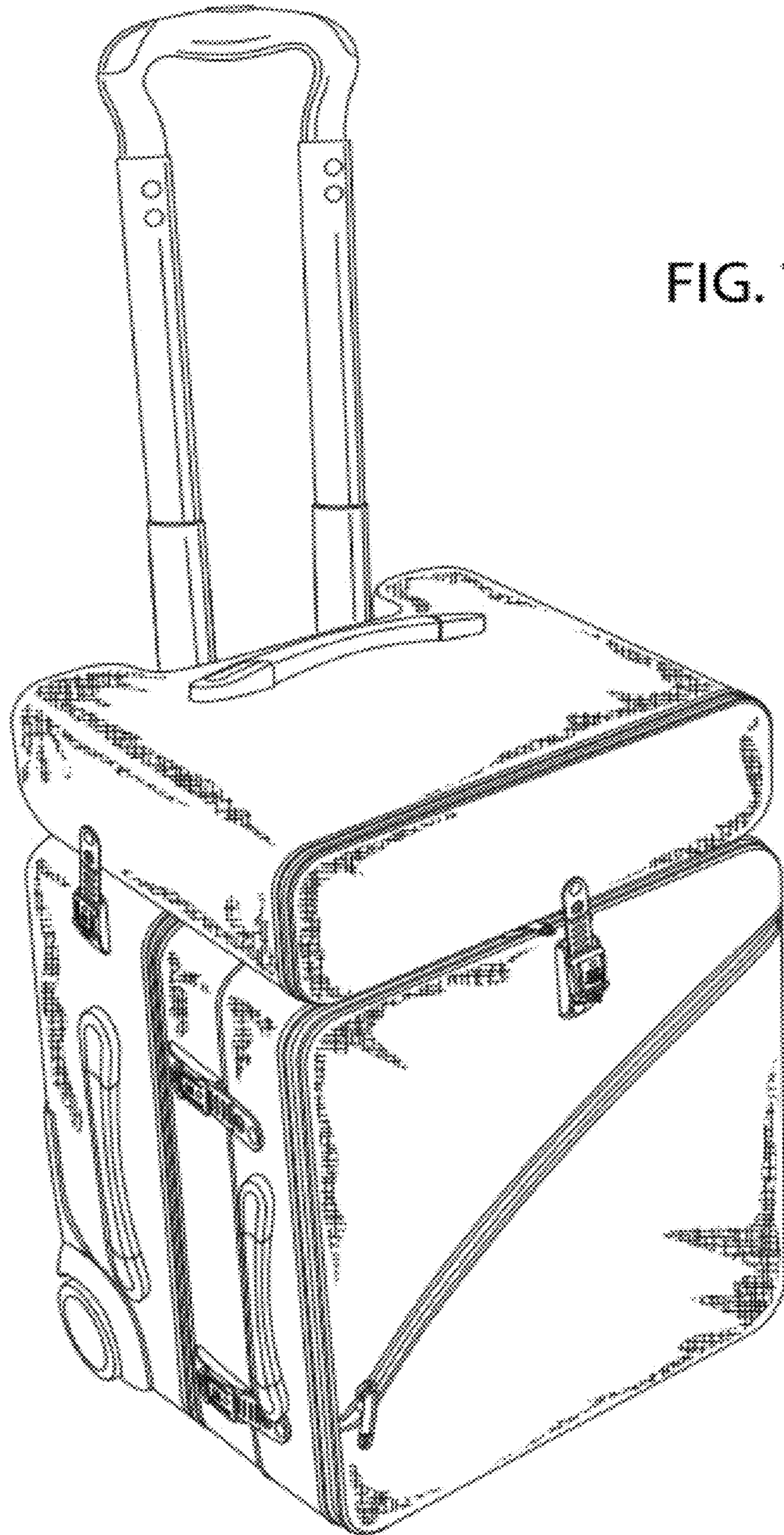

FIG. 7



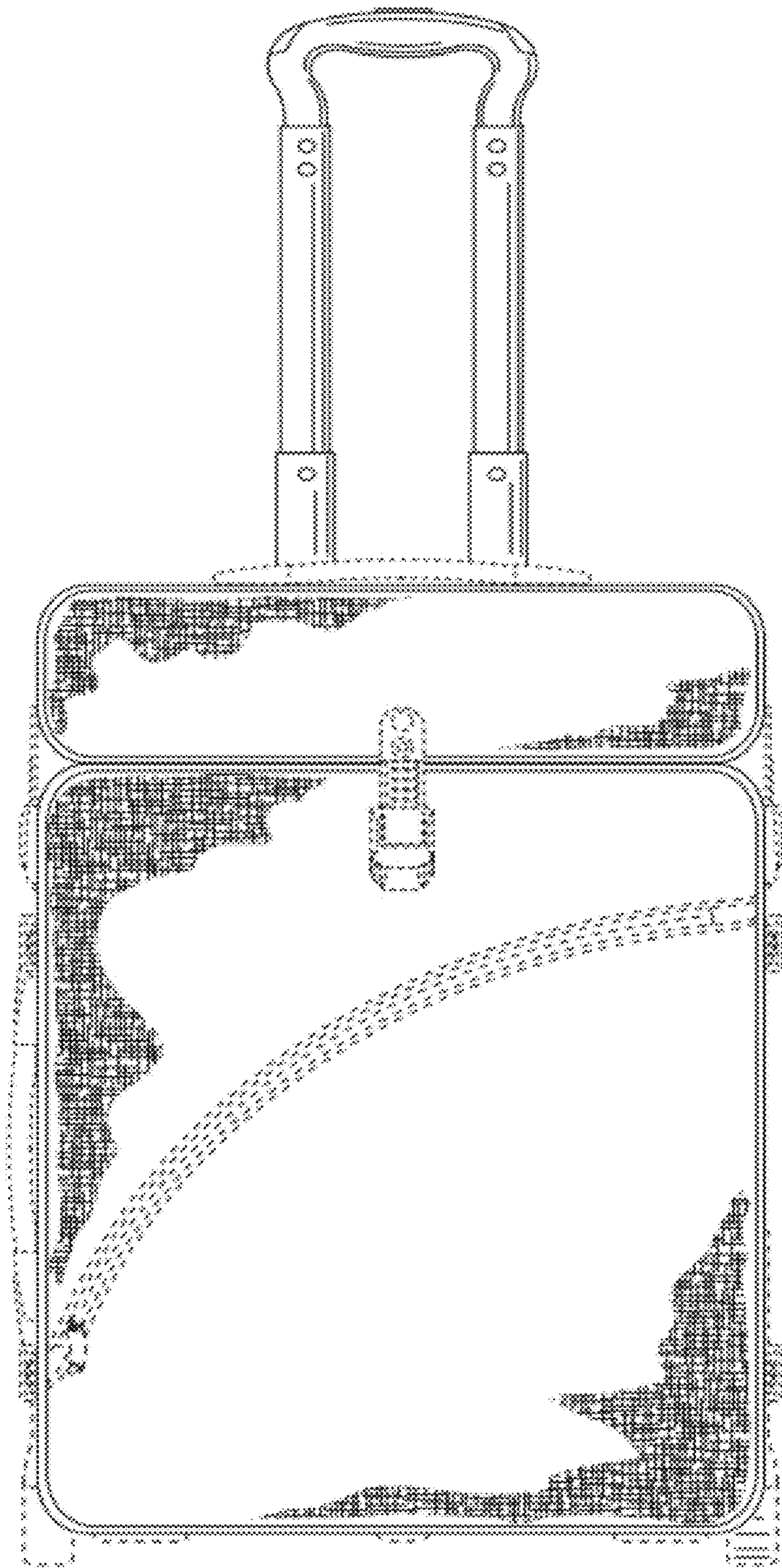

FIG. 9

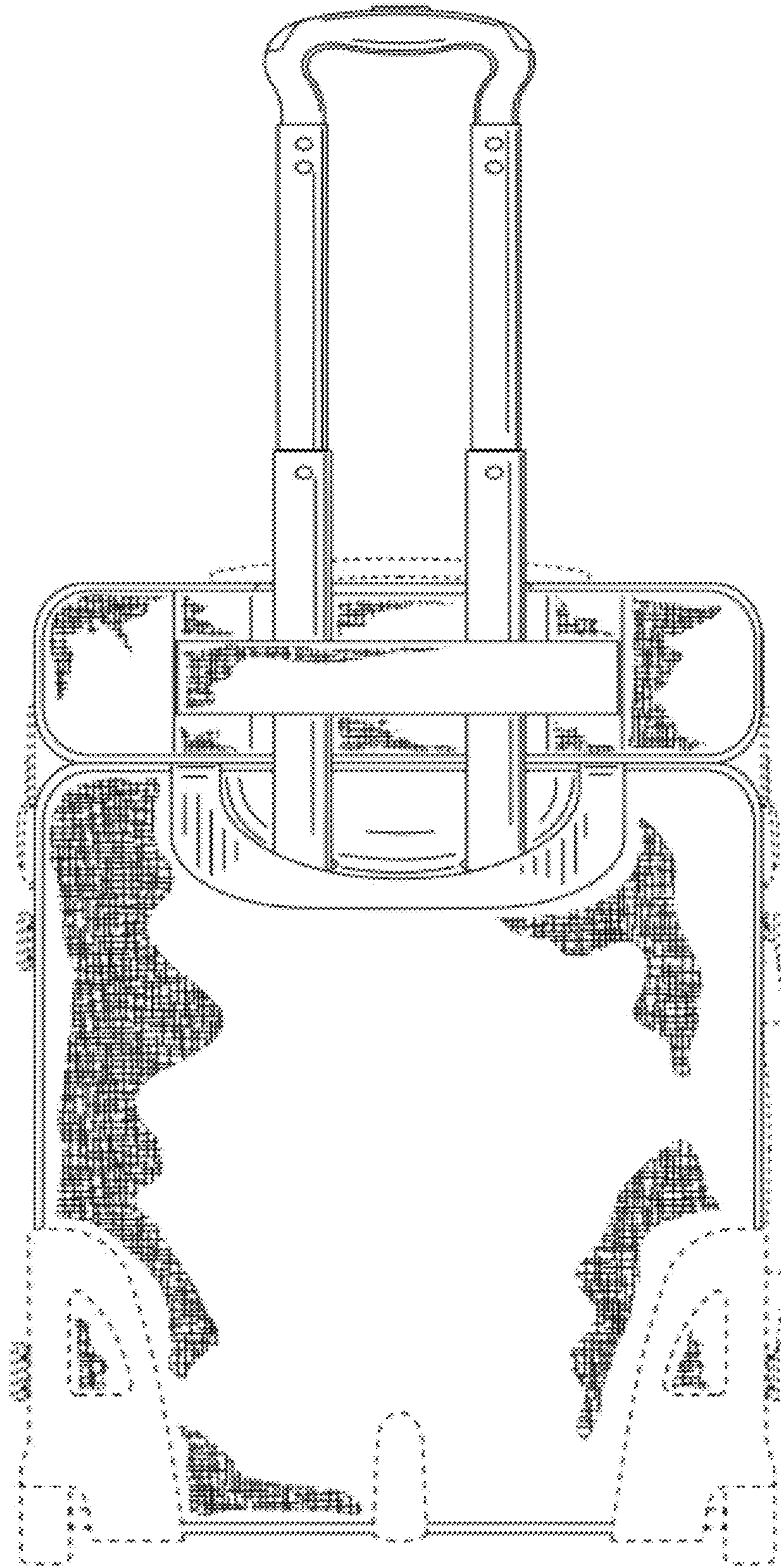

FIG. 10

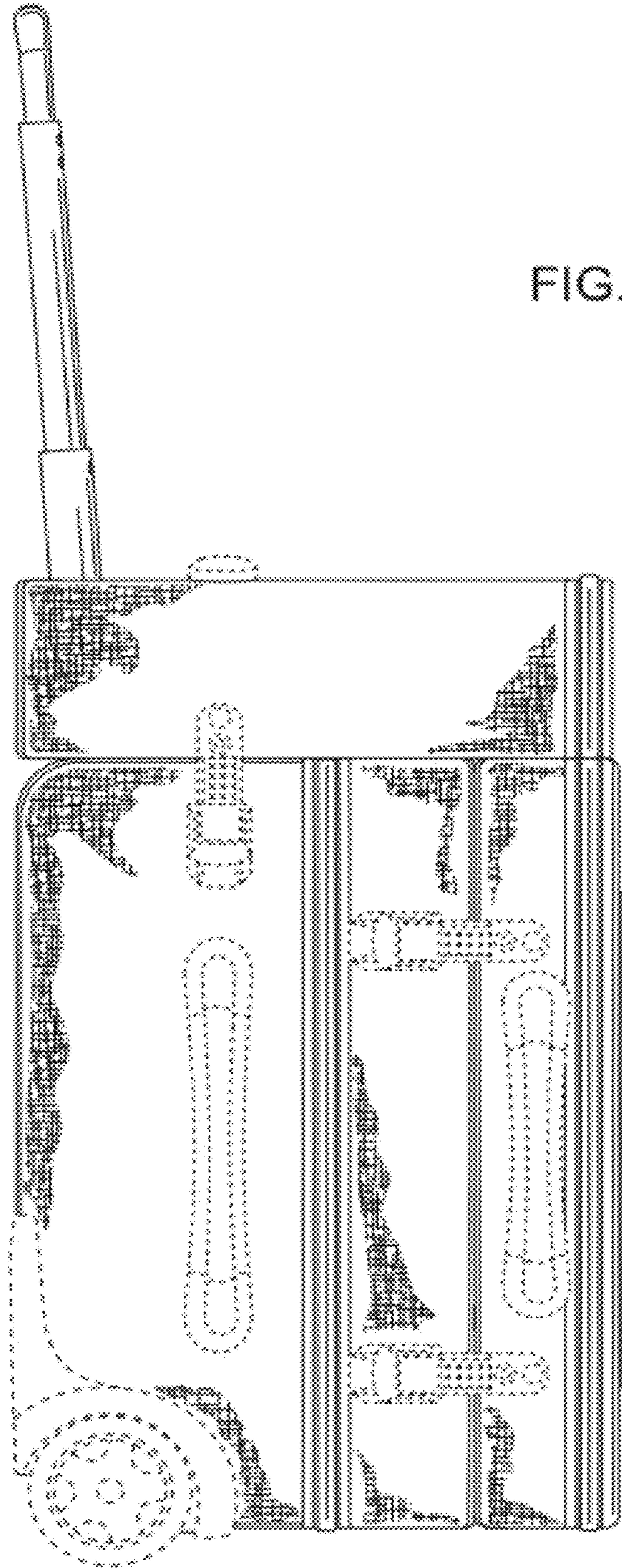
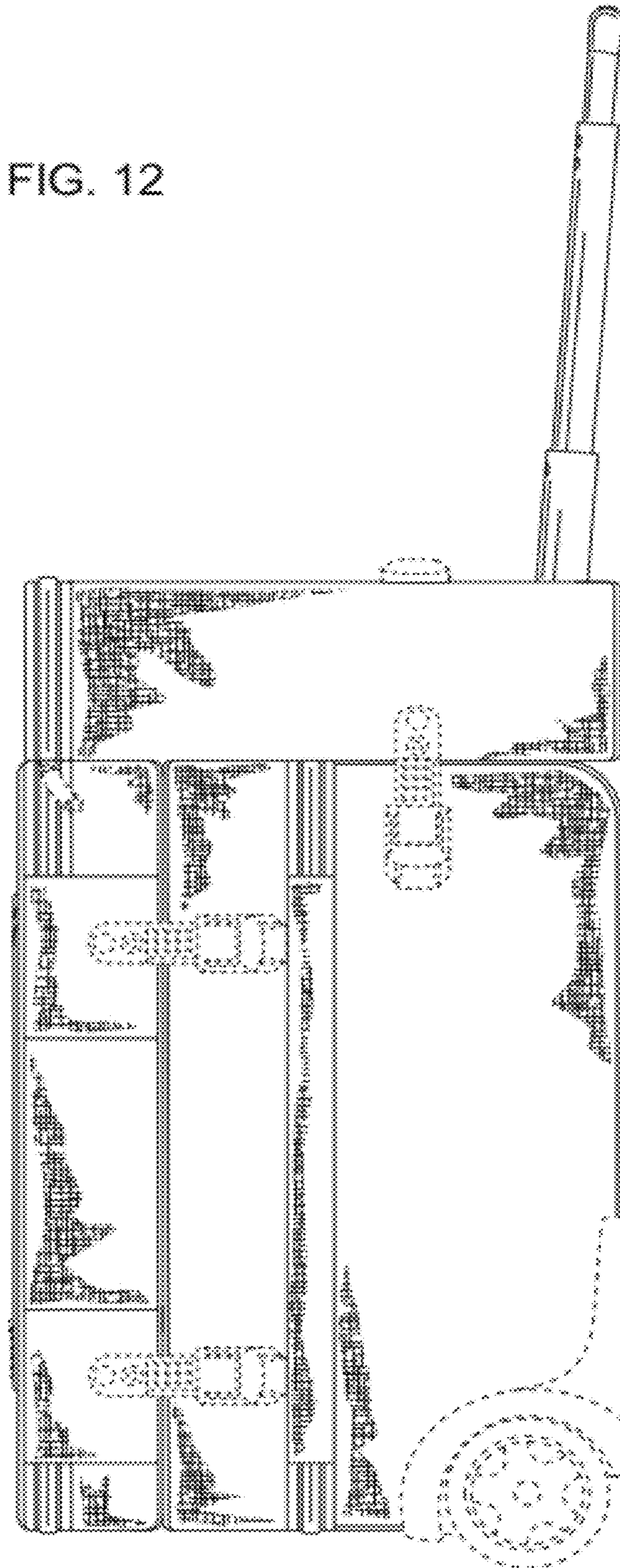

FIG. 11

FIG. 12



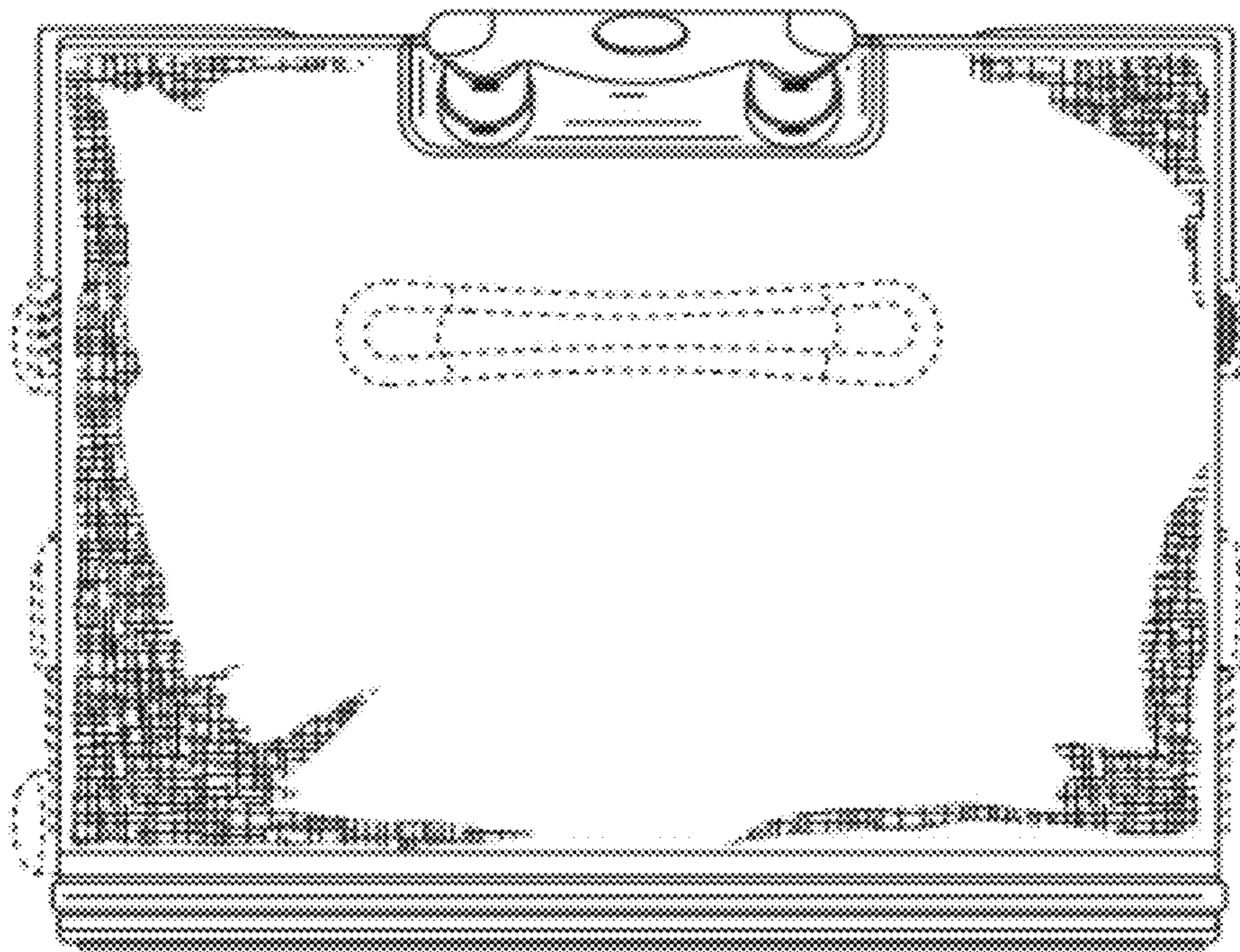

FIG. 13

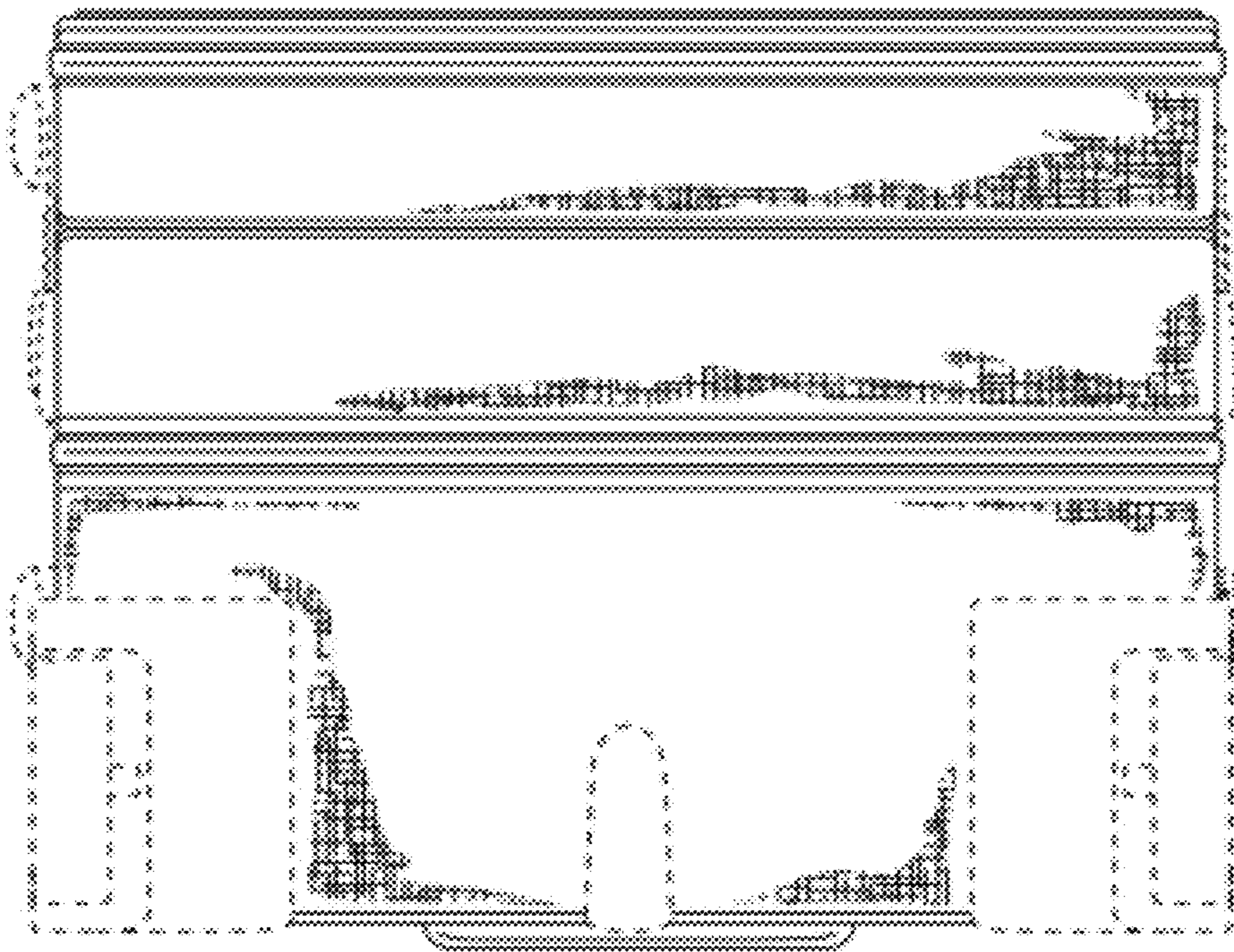

FIG. 14

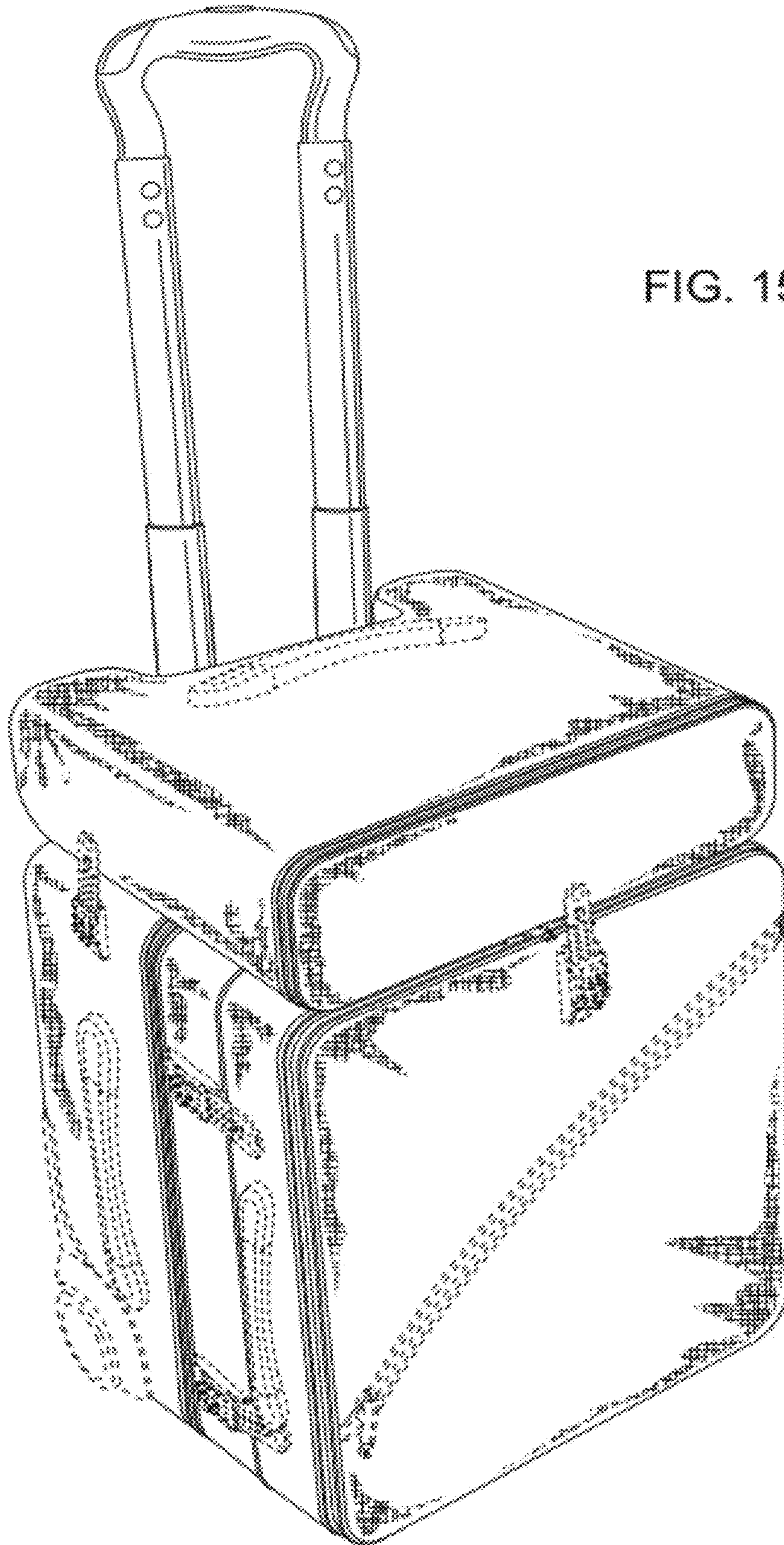

FIG. 15

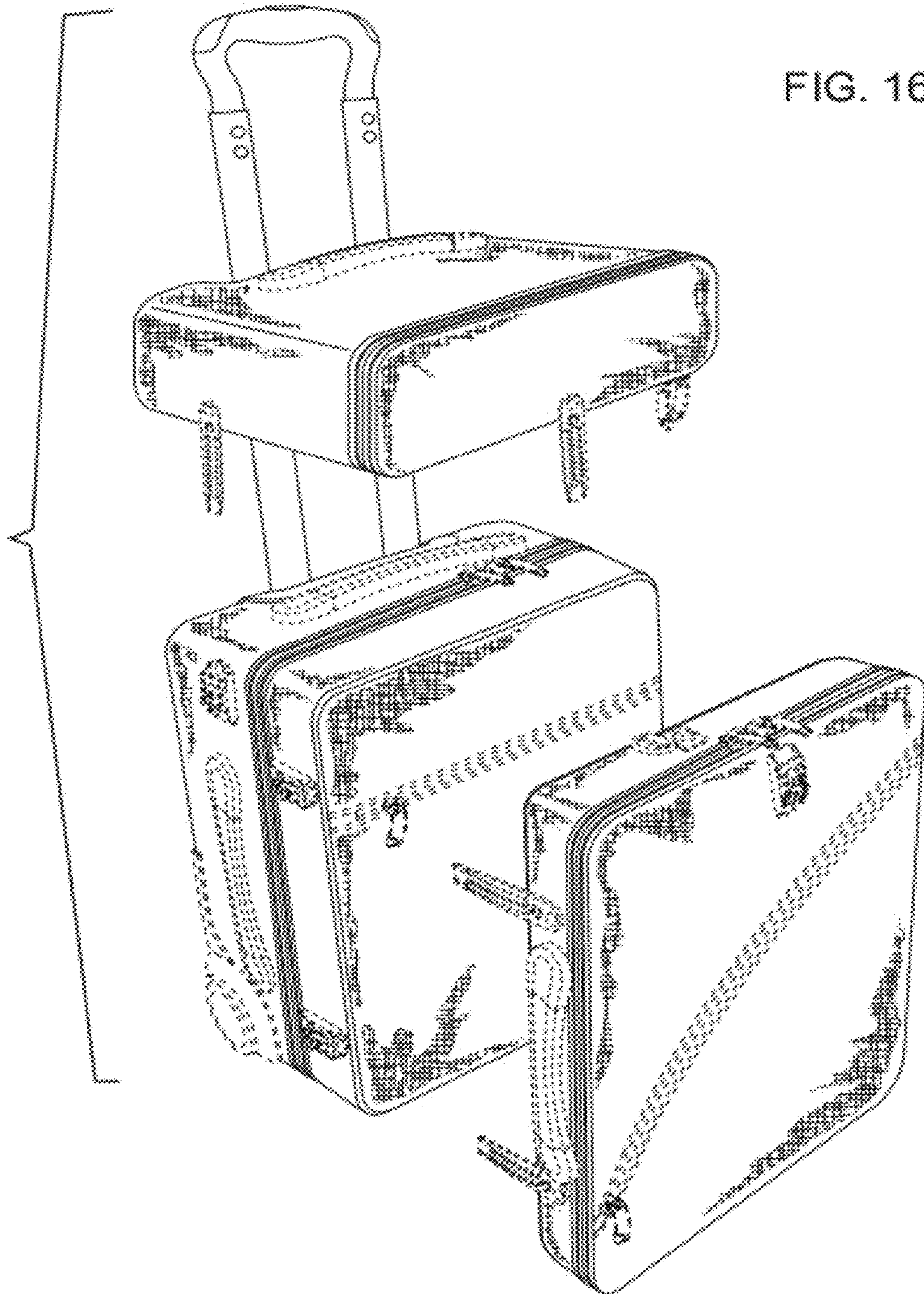

FIG. 16