



US00D671219S

(12) **United States Design Patent**
Donaldson

(10) **Patent No.:** **US D671,219 S**
(45) **Date of Patent:** **** Nov. 20, 2012**

- (54) **SPOOL AND BAIL VALVE**
- (75) Inventor: **Brad J. Donaldson**, Corvallis, OR (US)
- (73) Assignee: **Dental Components LLC**, Newberg, OR (US)
- (**) Term: **14 Years**
- (21) Appl. No.: **29/385,325**
- (22) Filed: **Feb. 11, 2011**
- (51) **LOC (9) Cl.** **24-02**
- (52) **U.S. Cl.** **D24/176; D24/128**
- (58) **Field of Classification Search** D24/108, D24/112, 152, 155-156, 176-177, 184-185, D24/127-129; 433/91-96, 98, 100; 604/247-248, 604/902, 119; D7/533; D8/300-302, 307-308; D23/233
See application file for complete search history.

(56) **References Cited**

U.S. PATENT DOCUMENTS

D115,667	S	*	7/1939	Curtiss	D8/308
3,208,145	A	*	9/1965	Turner	433/95
3,645,497	A	*	2/1972	Nyboer	433/95
4,017,975	A	*	4/1977	Johnson	433/94
4,354,837	A	*	10/1982	Moore	433/91
D279,925	S	*	7/1985	Wise	D24/129
4,861,266	A	*	8/1989	Ashiku	433/95
4,966,551	A	*	10/1990	Betush	433/95
5,295,830	A	*	3/1994	Shen et al.	433/91
D357,064	S	*	4/1995	Bartlett et al.	D24/111
5,779,472	A	*	7/1998	Meyer	433/91
5,924,866	A	*	7/1999	Eldreth	433/93
D541,378	S	*	4/2007	Sinvani	D23/233
7,287,981	B2	*	10/2007	Hirsch	433/95
2003/0219696	A1	*	11/2003	Moreland	433/95

OTHER PUBLICATIONS

DCI International, Product Catalog (2010), Vacuum Valves, (cover, subsection, pp. 66-68, and back cover) 7 pages.
 Untitled vacuum valve, [online] [retrieved Nov. 5, 2010]. Retrieved from the Internet: <URL: <http://www.kabdental.com/dental-service-parts/dci/5070.jpg>>. 1 page.

DCI Dental HVE Vacuum Valves—2 Kits—6 Valves—eBay (item 380208739887 end time Nov. 17, 2010-1 . . . [online] [retrieved Nov. 5, 2010]. Retrieved from the Internet: <URL: http://cgi.ebay.com/DCI-Dental-HVE-Vacuum-Valves-2-Kits-6-Valves-/380208739887?pt=LH_Default>. 1 page.
 Untitled vacuum valve, [online] [retrieved Nov. 5, 2010]. Retrieved from the Internet: <URL: <http://www.kabdental.com/dental-service-parts/dci/5080.jpg>>. 1 page.
 DCI Dental HVE Vacuum Valves—2 Kits—6 Valves—eBay (item 380208748361 end time Nov. 17, 2010 12:20:2 . . . [online] [retrieved Nov. 5, 2010]. Retrieved from the Internet: <URL: http://cgi.ebay.com/DCI-Dental-HVE-Vacuum-Valves-2-Kits-6-Valves-/380208748361?pt=LH_DefaultDomai...>. 1 page.
 Untitled vacuum valve, [online] [retrieved Nov. 5, 2010]. Retrieved from the Internet: <URL: [http://i.ebayimg.com/23/!B5komFwB2k~\\$\(KGrHqJ,!jQEYbvDu\(F9BMuKyBpCsw~_12.JPG](http://i.ebayimg.com/23/!B5komFwB2k~$(KGrHqJ,!jQEYbvDu(F9BMuKyBpCsw~_12.JPG)>. 1 page.

(Continued)

Primary Examiner — Wan Laymon
 (74) *Attorney, Agent, or Firm* — Alston & Bird LLP

(57) **CLAIM**

The ornamental design for a spool and bail valve, as shown and described.

DESCRIPTION

FIG. 1 is a perspective view of a spool and bail valve according to my new design;
 FIG. 2 is another perspective view thereof;
 FIG. 3 is a front elevation view thereof;
 FIG. 4 is a rear elevation view thereof;
 FIG. 5 is a right side elevation view thereof;
 FIG. 6 is a left side elevation view thereof;
 FIG. 7 is a top plan view thereof;
 FIG. 8 is a bottom plan view thereto;
 FIG. 9 is a perspective view of another spool and bail valve according to my new design;
 FIG. 10 is another perspective view thereof;
 FIG. 11 is a front elevation view thereof;
 FIG. 12 is a rear elevation view thereof;
 FIG. 13 is a right side elevation view thereof;
 FIG. 14 is a left side elevation view thereof;
 FIG. 15 is a top plan view thereof; and,
 FIG. 16 is a bottom plan view thereto.
 The broken lines are directed to environment and are for illustrative purposes only. The broken lines form no part of the claimed design.

1 Claim, 8 Drawing Sheets

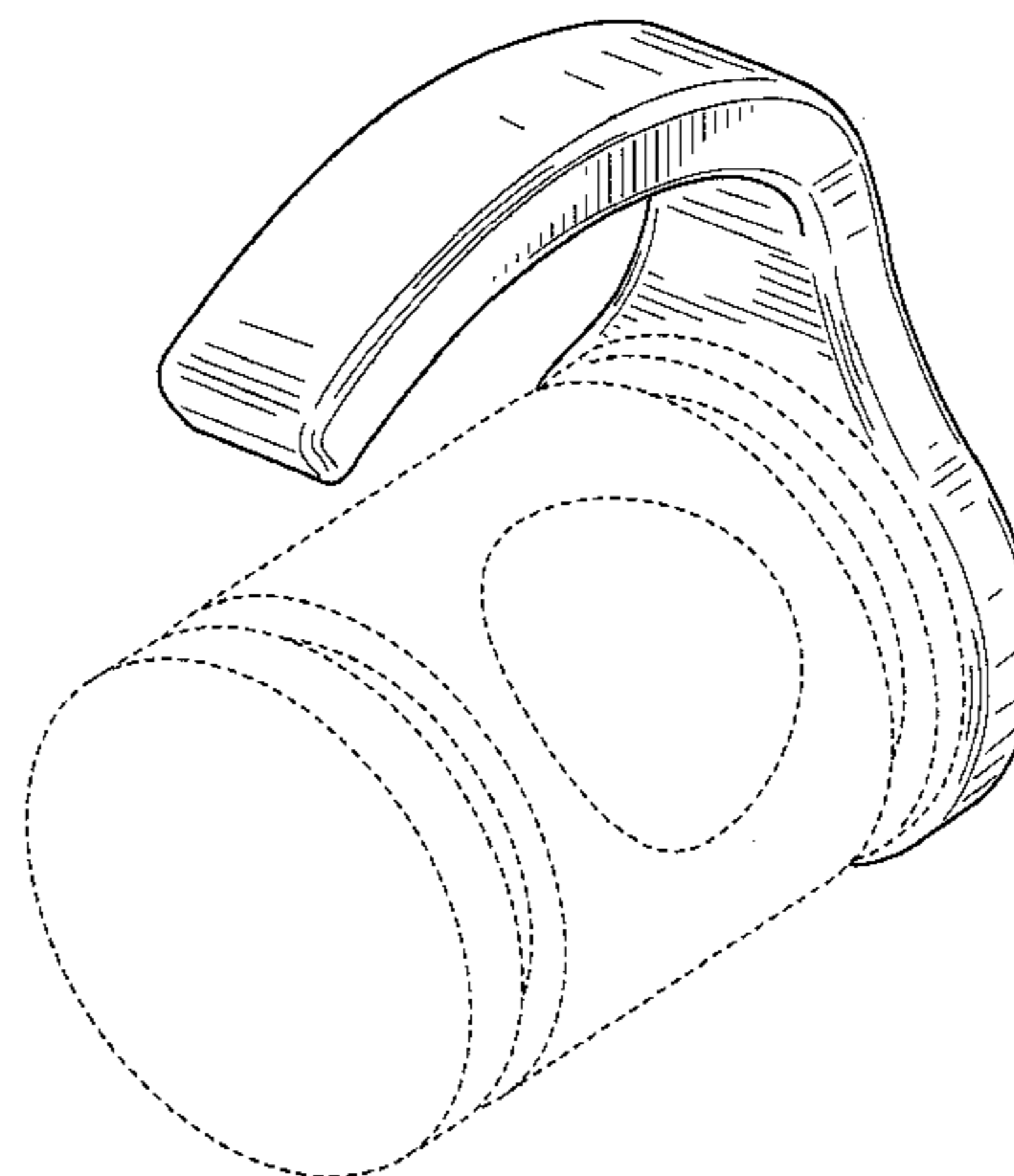
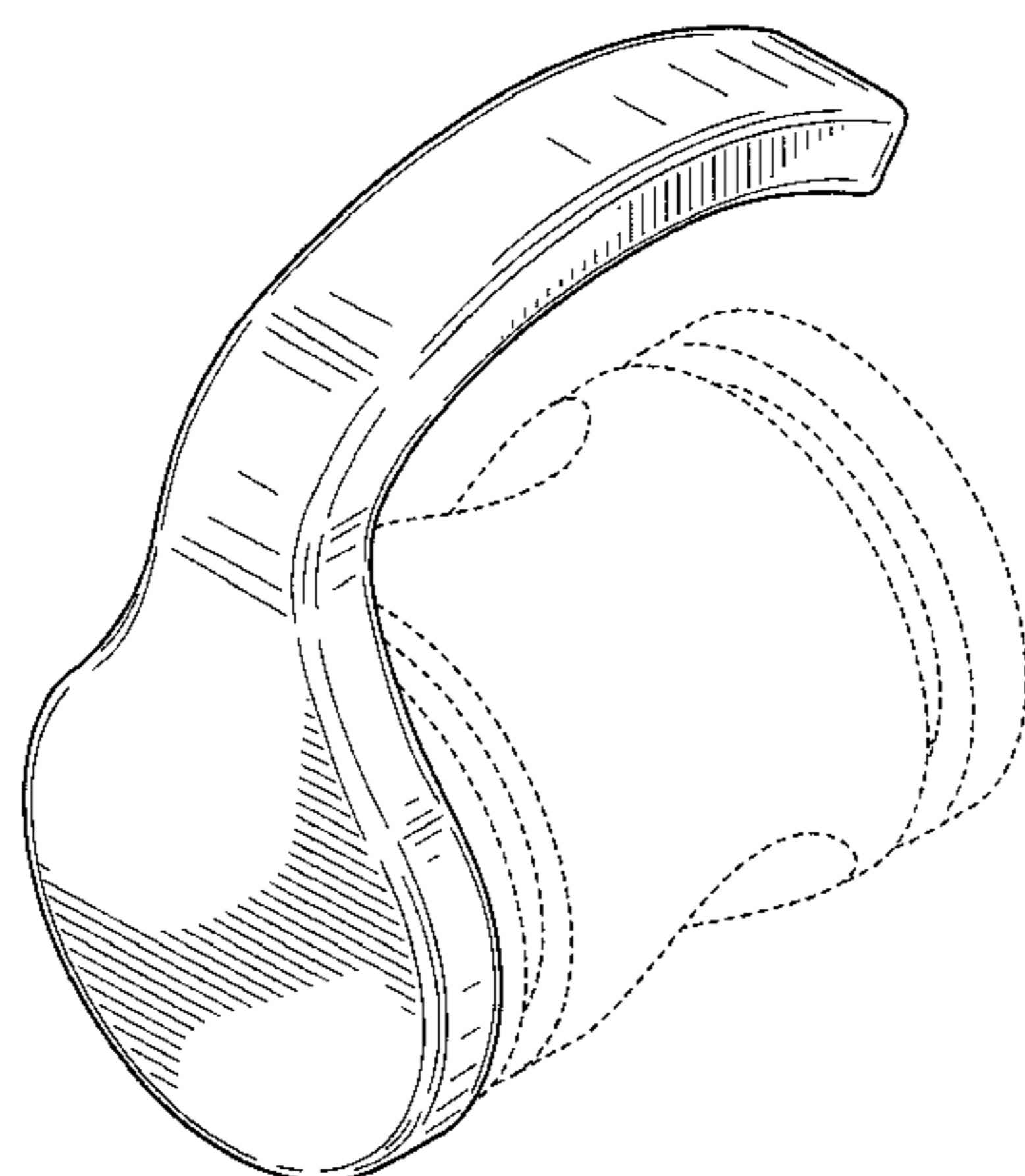

OTHER PUBLICATIONS

DCI Premium Saliva Ejector Valves (Pack Of 4 Valves)—eBay (item 380208753690 end time Nov. 17- . . . [online] [retrieved Nov. 5, 2010]. Retrieved from the Internet: <URL: http://cgi.ebay.com/DCI-Premium-Saliva-Ejector-Valves-Pack-4-Valves-/380208753690?pt=LH_Default...>. 1 page.

Untitled vacuum valve, [online] [retrieved Nov. 5, 2010]. Retrieved from the Internet: <URL: [http://i.ebayimg.com/09/!Bmkfp\(wBWk~\\$\(KGrHgoH-C!EjIL10vkgBLgEiC\(G,w~~_12.JPG](http://i.ebayimg.com/09/!Bmkfp(wBWk~$(KGrHgoH-C!EjIL10vkgBLgEiC(G,w~~_12.JPG)>. 1 page.

Dental Equipment—2 Stainless Saliva Ejector Valves—eBay (item 380230575481 end time Nov. 30, 2010 0 . . . [online] [retrieved Nov. 5, 2010]. Retrieved from the Internet: <URL: http://cgi.ebay.com/Dental-Equipment-2-Stainless-Saliva-Ejector-Valves-/380230575481?pt=LH_Default...>. 1 page.

Untitled vacuum valve, [online] [retrieved Nov. 5, 2010]. Retrieved from the Internet: <URL: [http://i.ebayimg.com/20/!BsfsREg!2k~\\$\(KGrHqMH-CMEvC3Une4iBL4F7k5-Lw~~_3.JPG](http://i.ebayimg.com/20/!BsfsREg!2k~$(KGrHqMH-CMEvC3Une4iBL4F7k5-Lw~~_3.JPG)>. 1 page.

Dental Saliva Ejector Valve—2 Pc Valve—eBay (item 400073583444 end time Nov. 9, 2010 19:24:21 PST) [online] [online] [retrieved Nov. 5, 2010]. Retrieved from the Internet: <URL: http://cgi.ebay.com/Dental-Saliva-Ejector-Valve-2-Pc-Valve-/400073583444?pt=LH_DefaultDomain_0&...>. 1 page.

Untitled vacuum valve, [online] [retrieved Nov. 5, 2010]. Retrieved from the Internet: <URL: http://i.ebayimg.com/02/i/000/fc/ca/1649_1.JPG>. 1 page.

Stainless Steel Saliva Ejector Valves (Pack Of 3) New—eBay (item 380113065919 end time Nov. 14-1 . . . [online] [retrieved Nov. 5, 2010]. Retrieved from the Internet: <URL: http://cgi.ebay.com/Stainless-Steel-Saliva-Ejector-Valves-Pack-3-NEW-/380113065919?pt=LH_Default...>. 1 page.

* cited by examiner

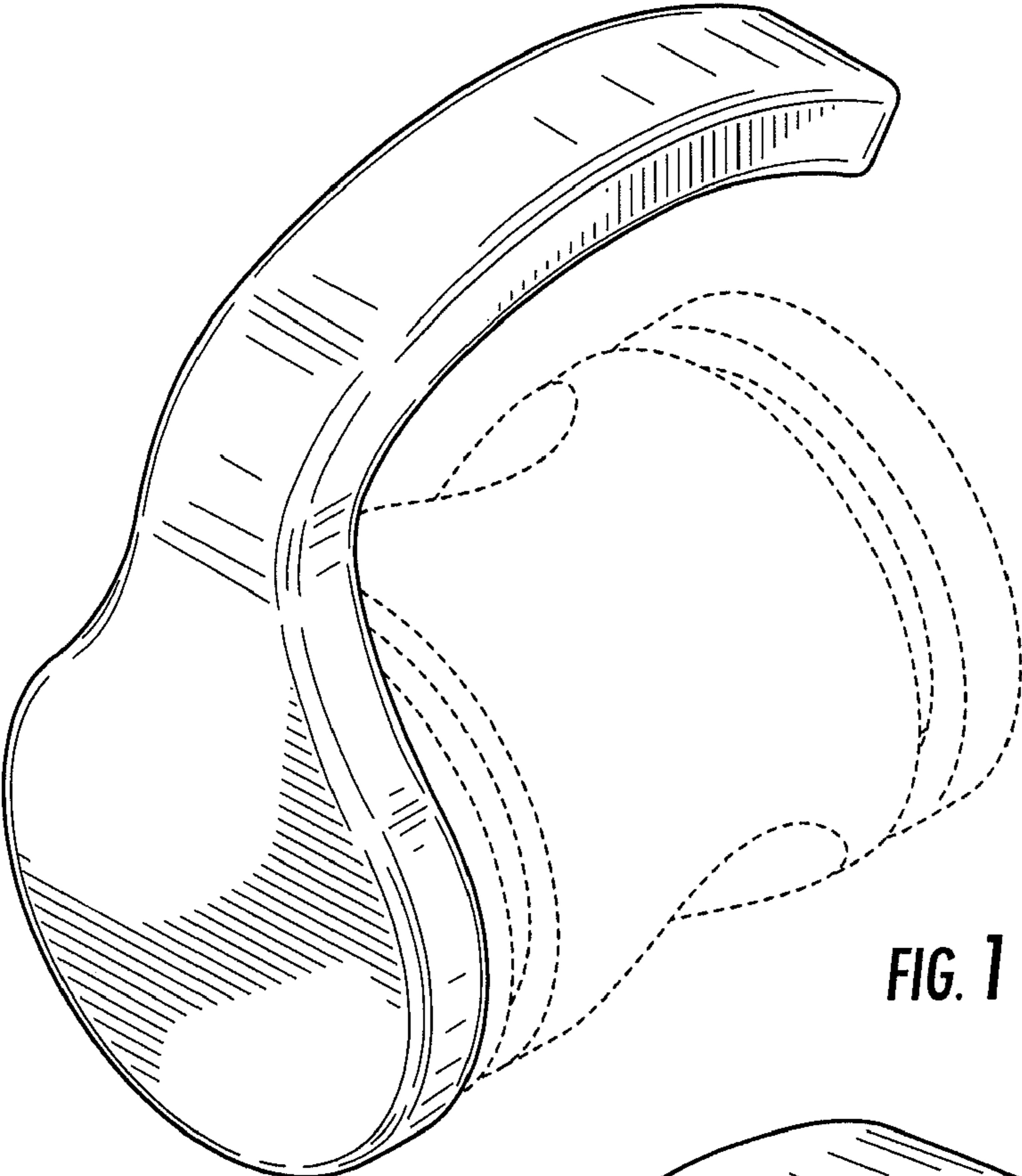

FIG. 1

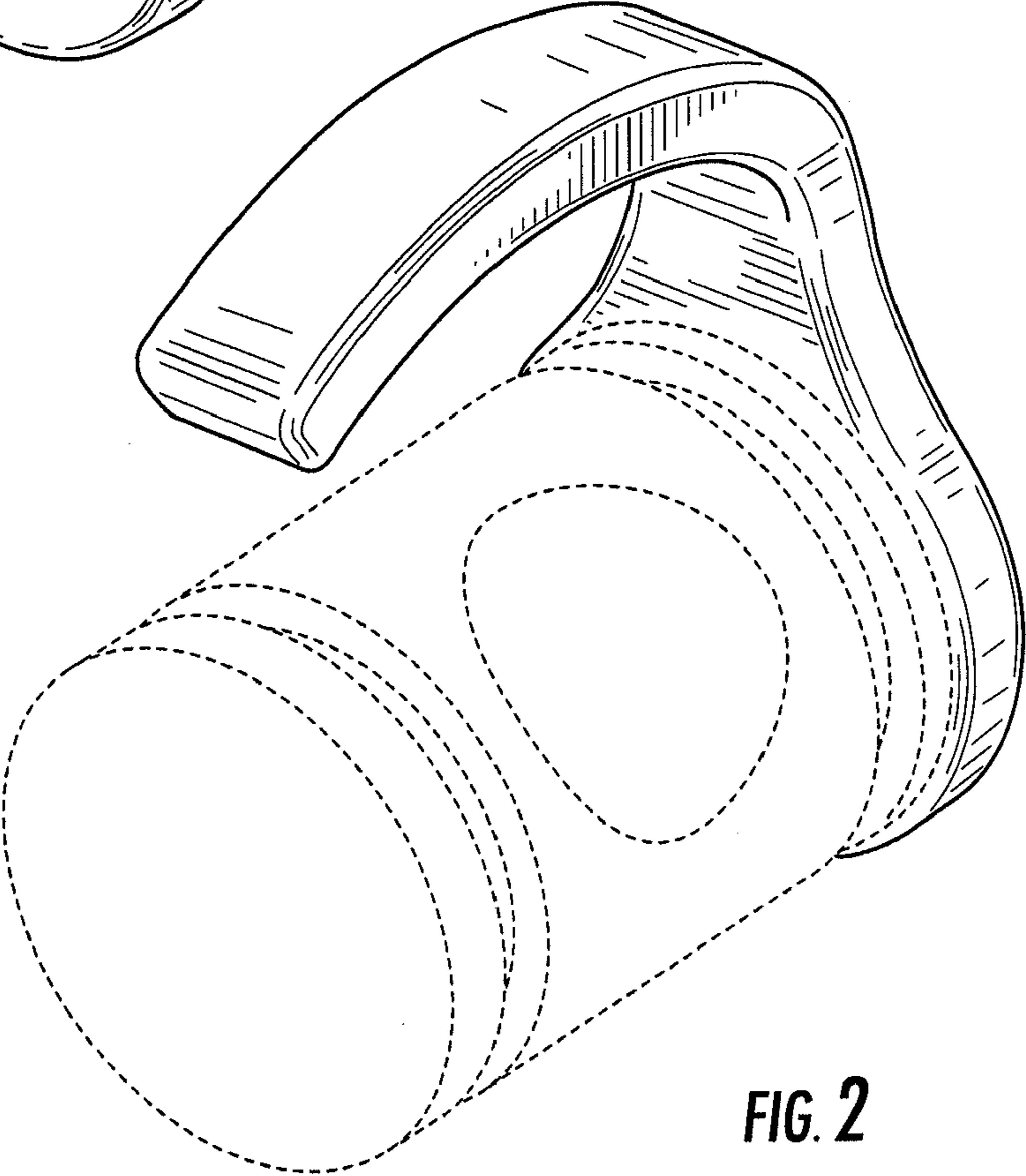

FIG. 2

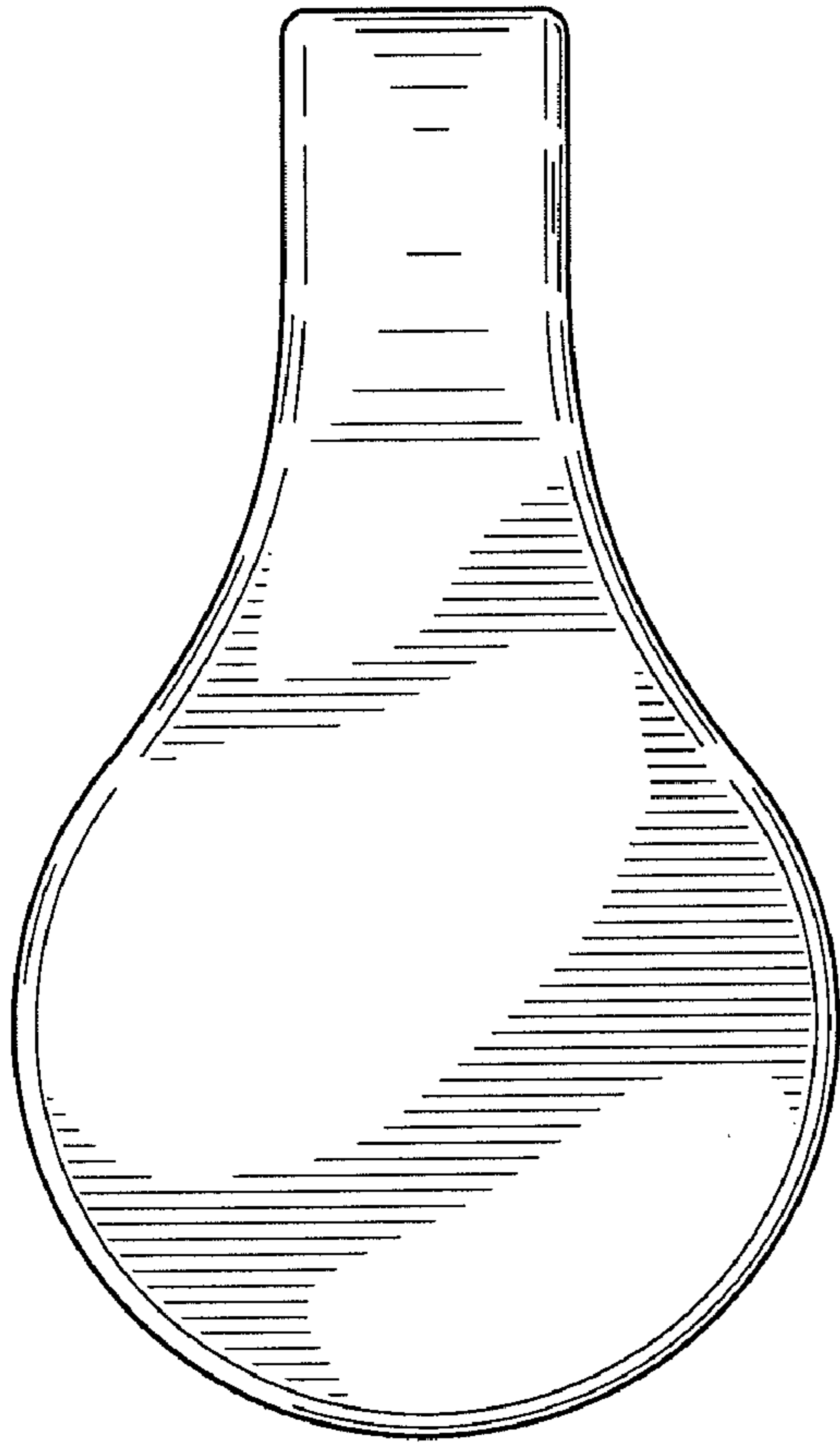

FIG. 3

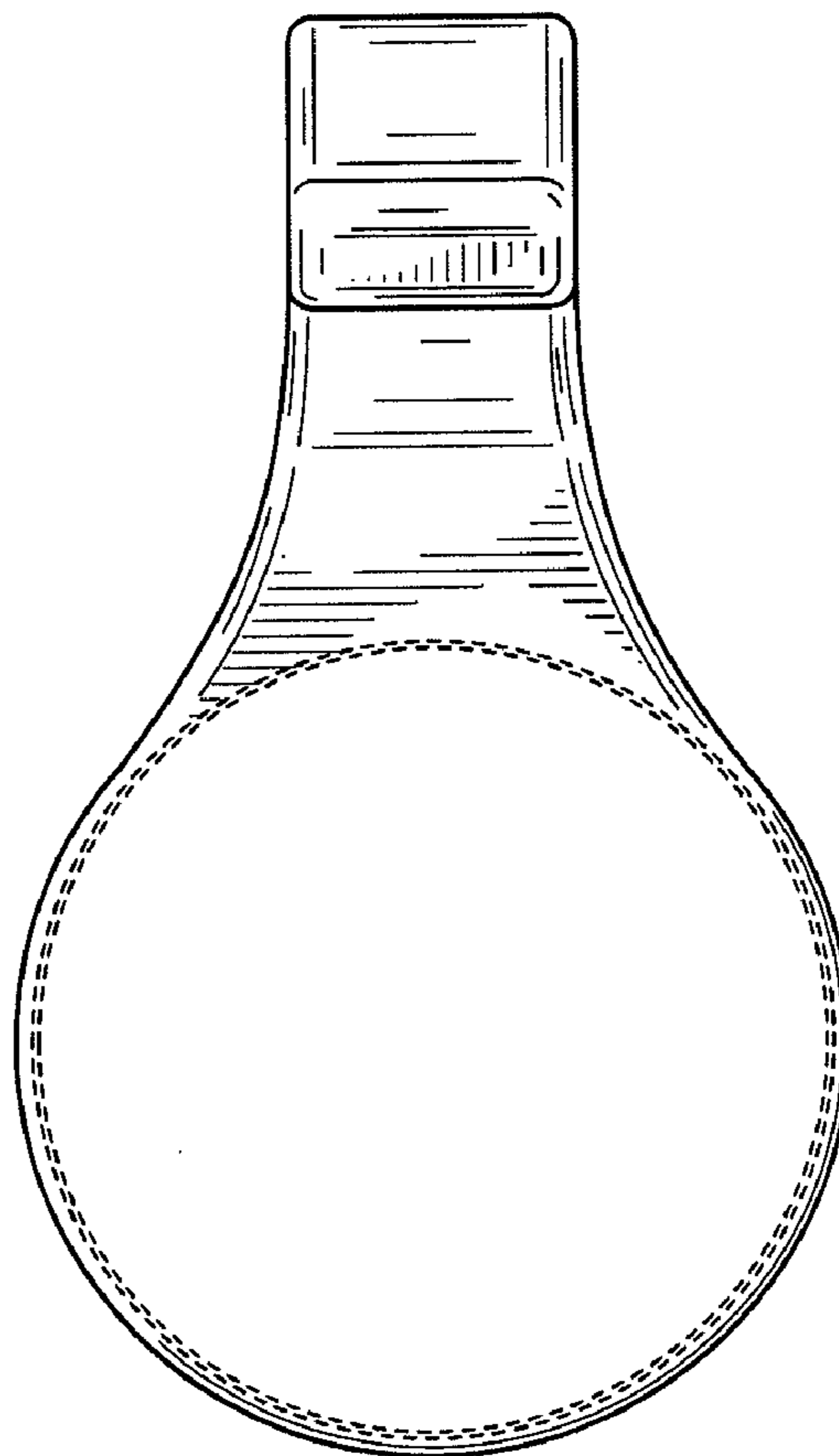

FIG. 4

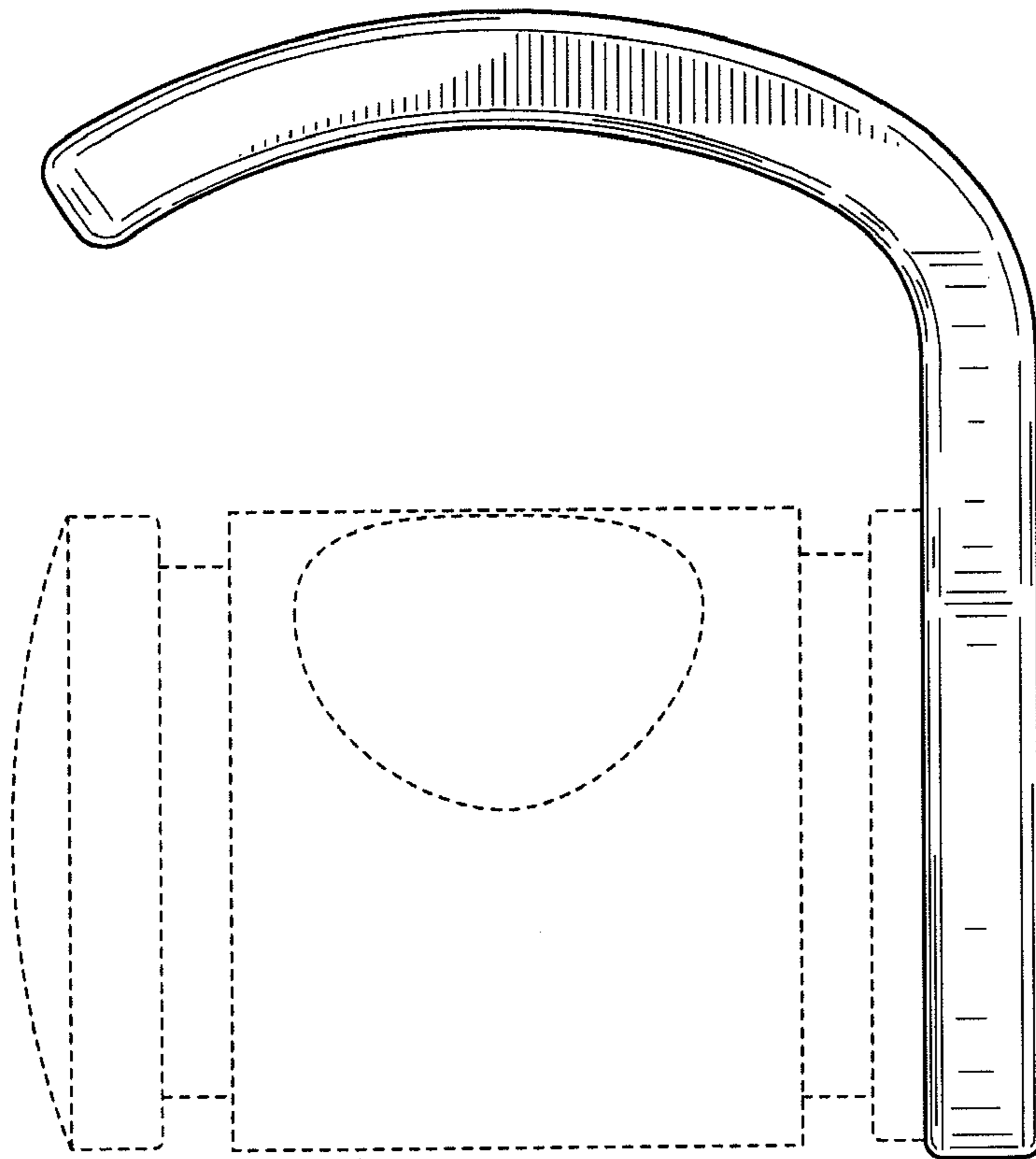

FIG. 5

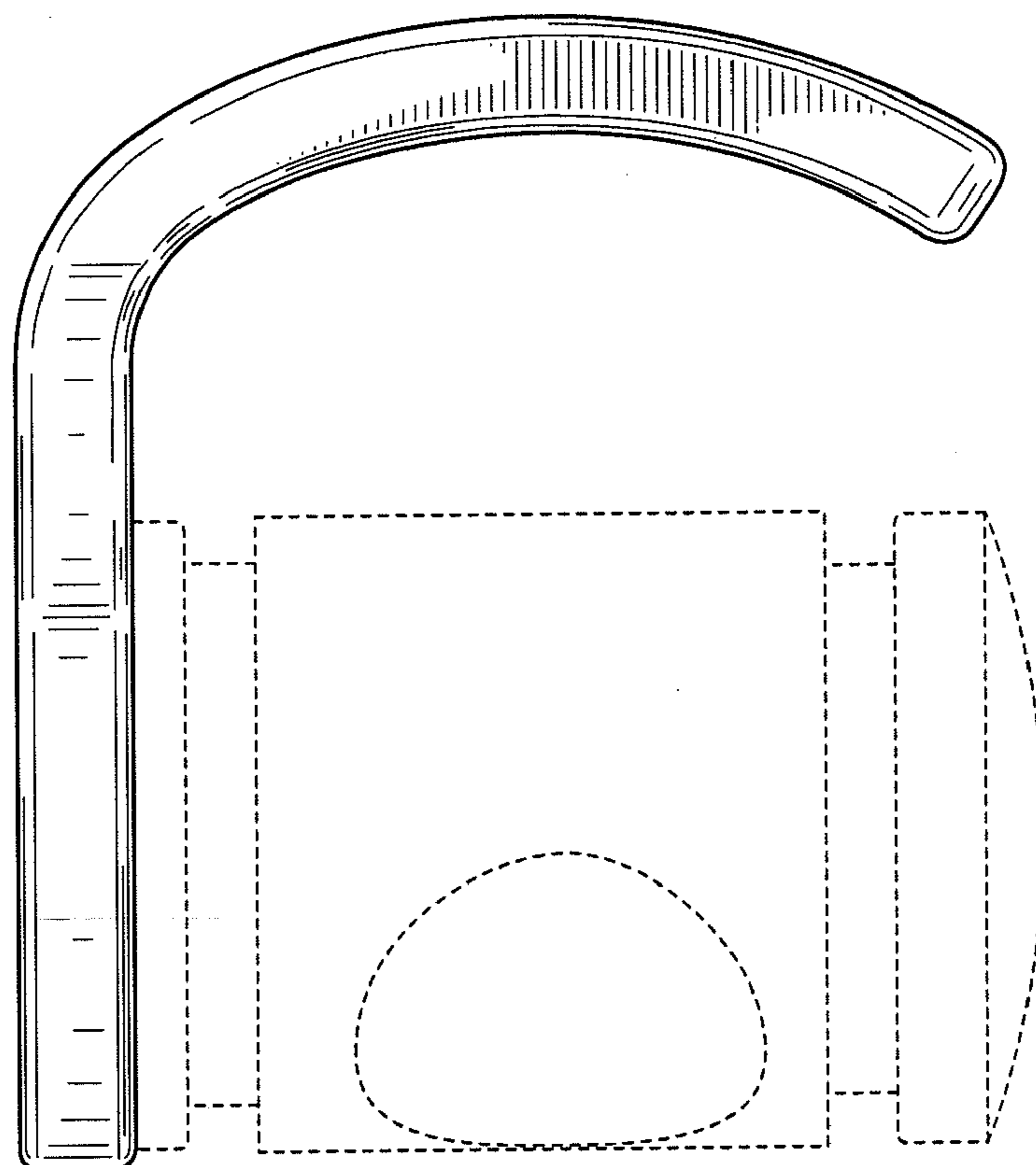

FIG. 6

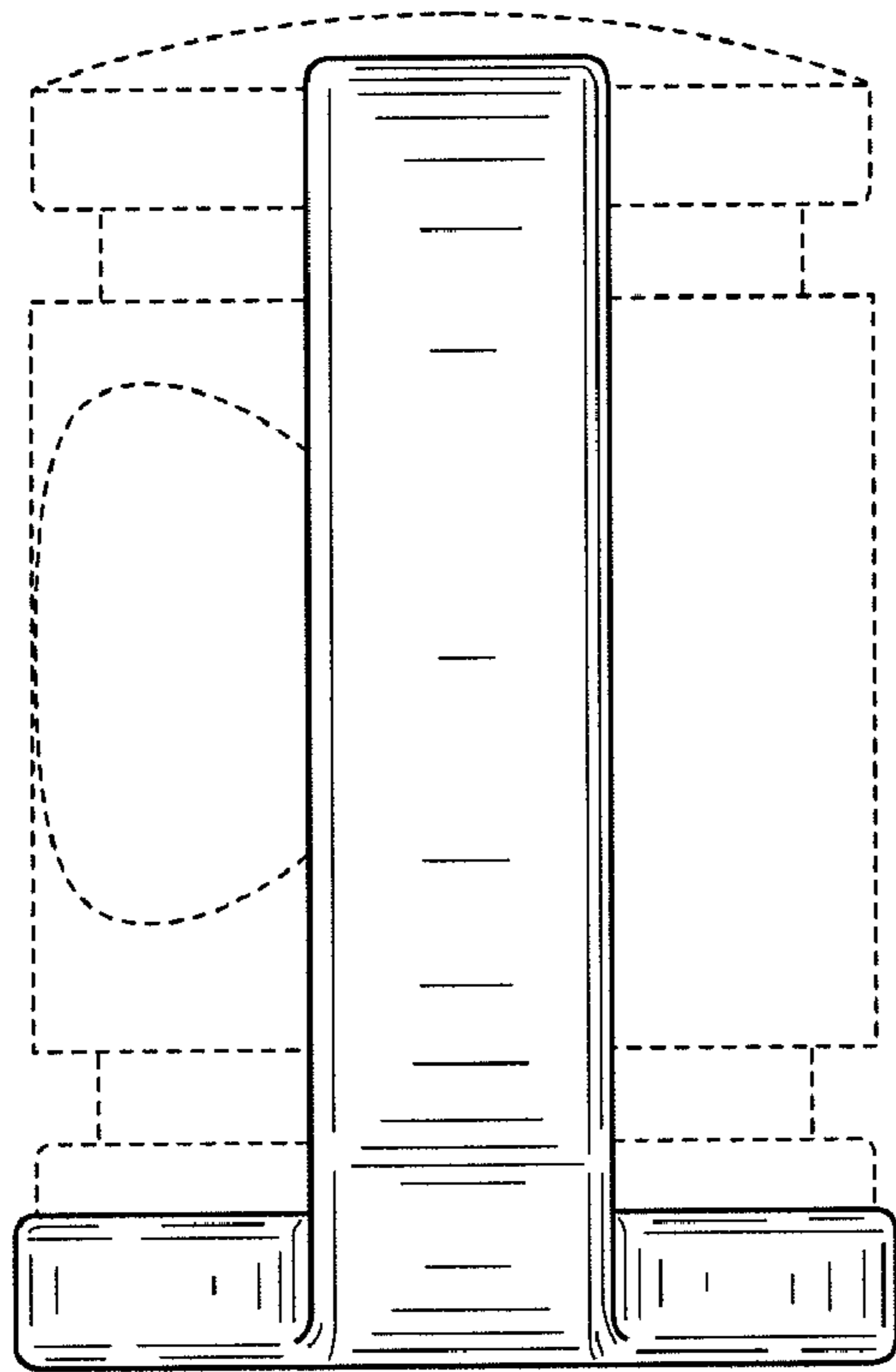

FIG. 7

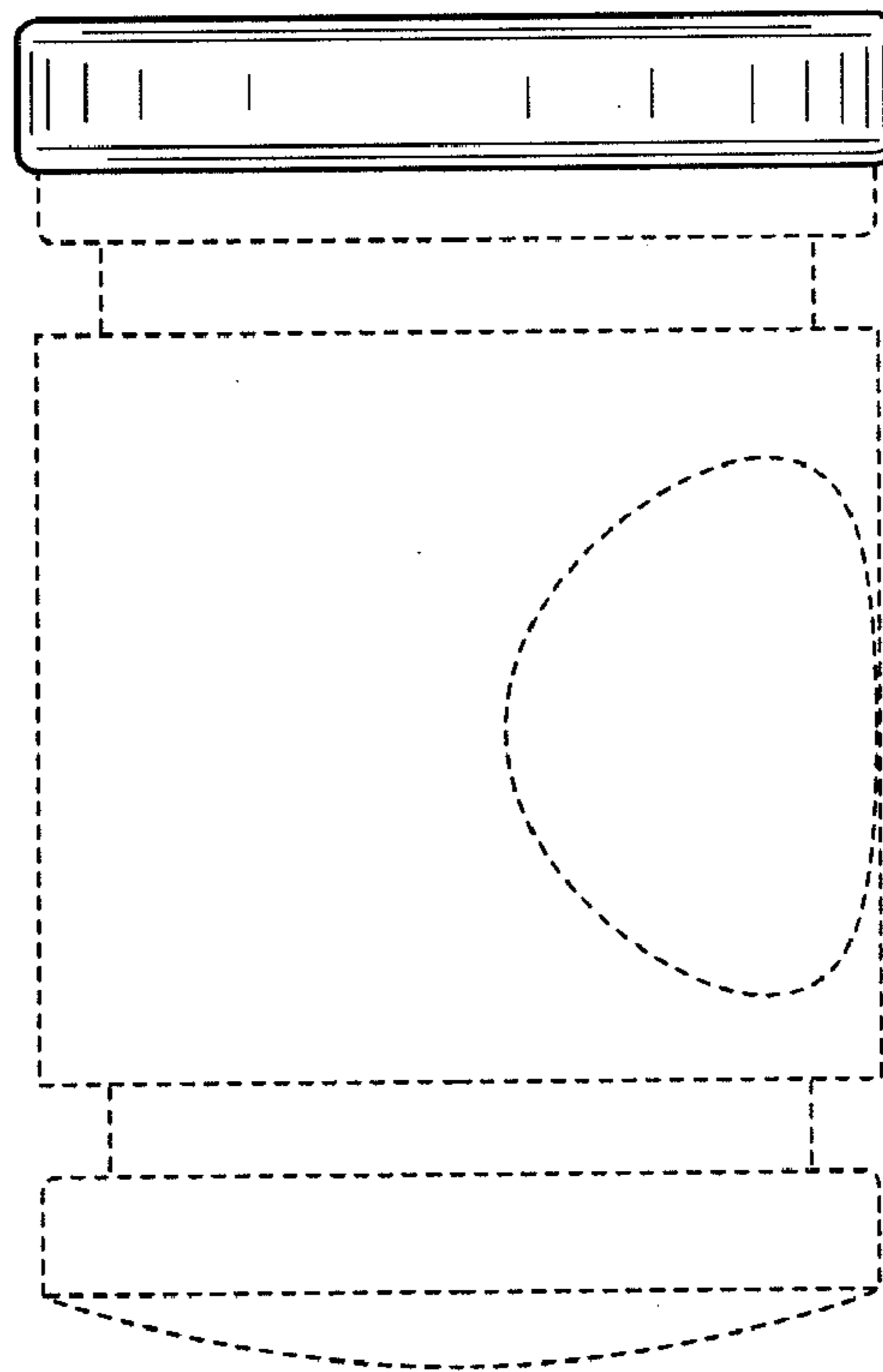

FIG. 8

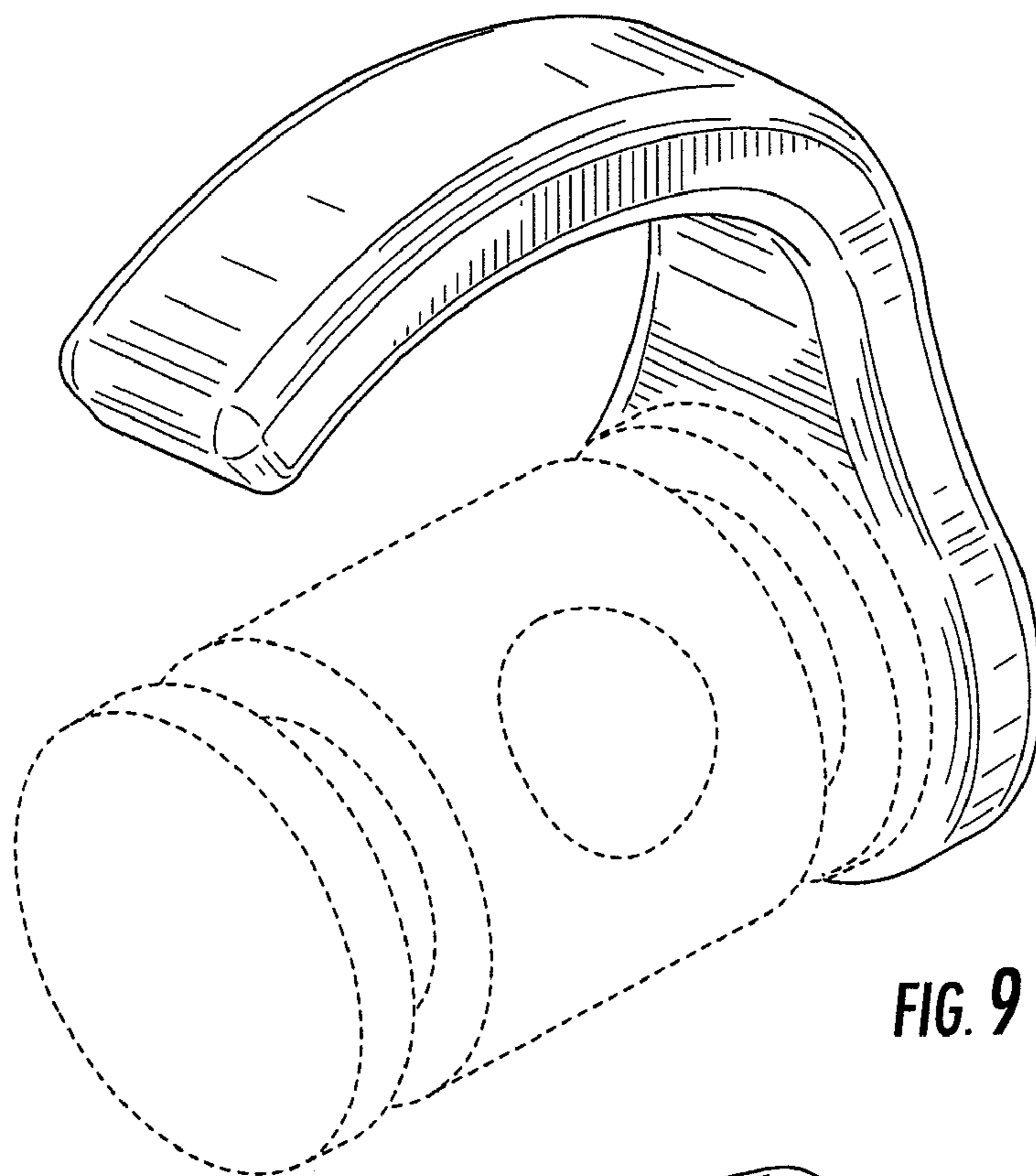

FIG. 9

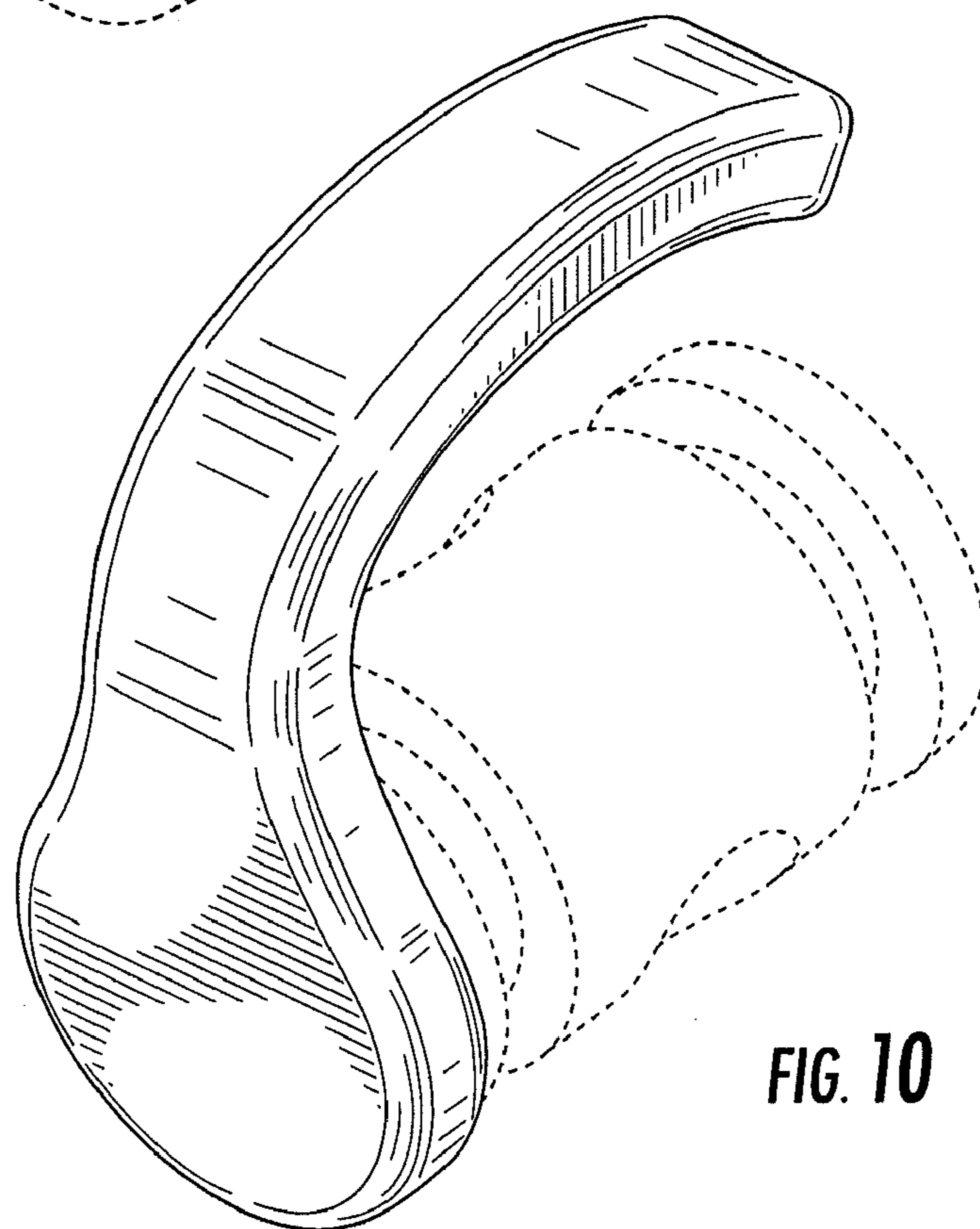

FIG. 10

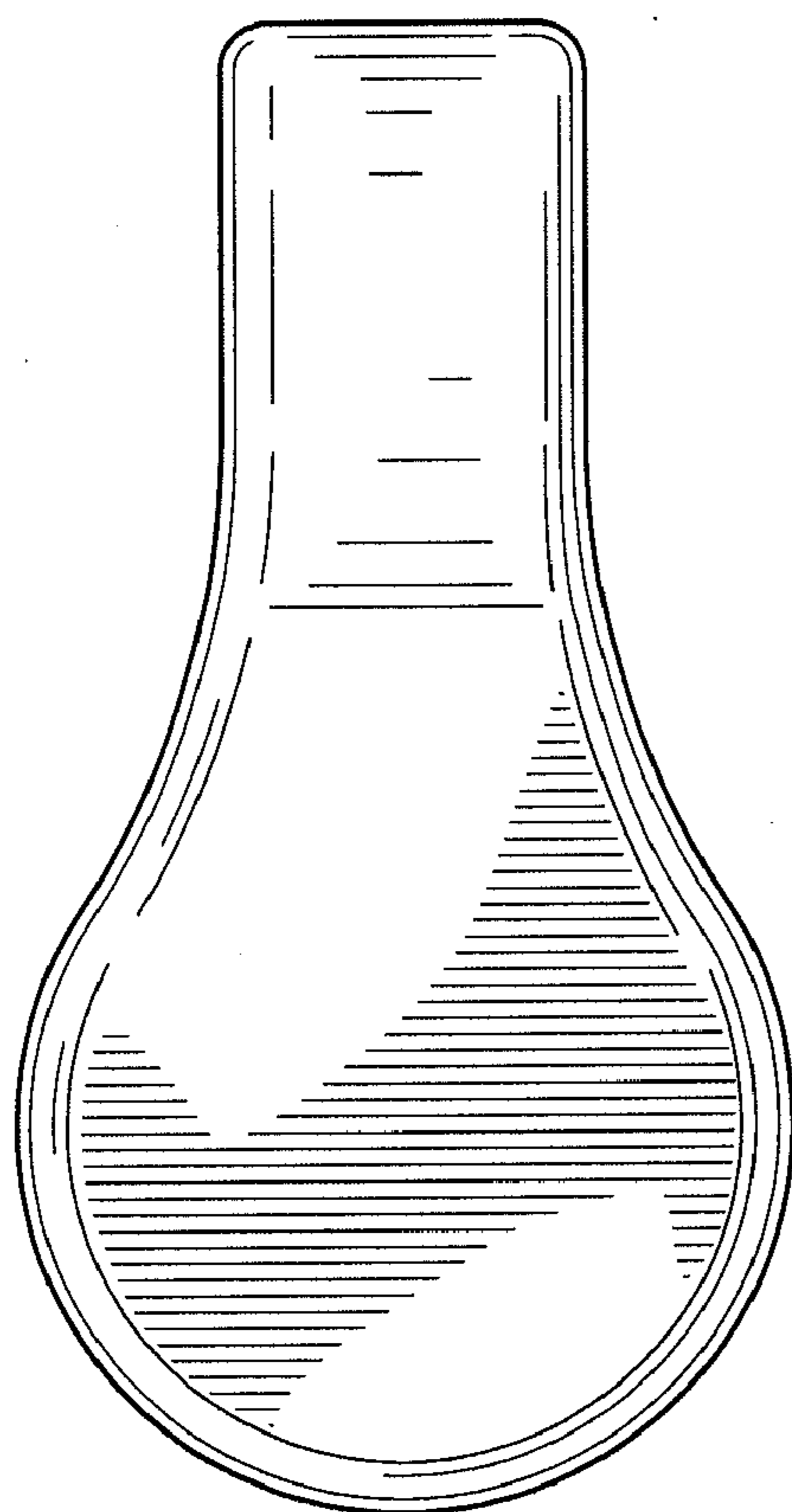

FIG. 11

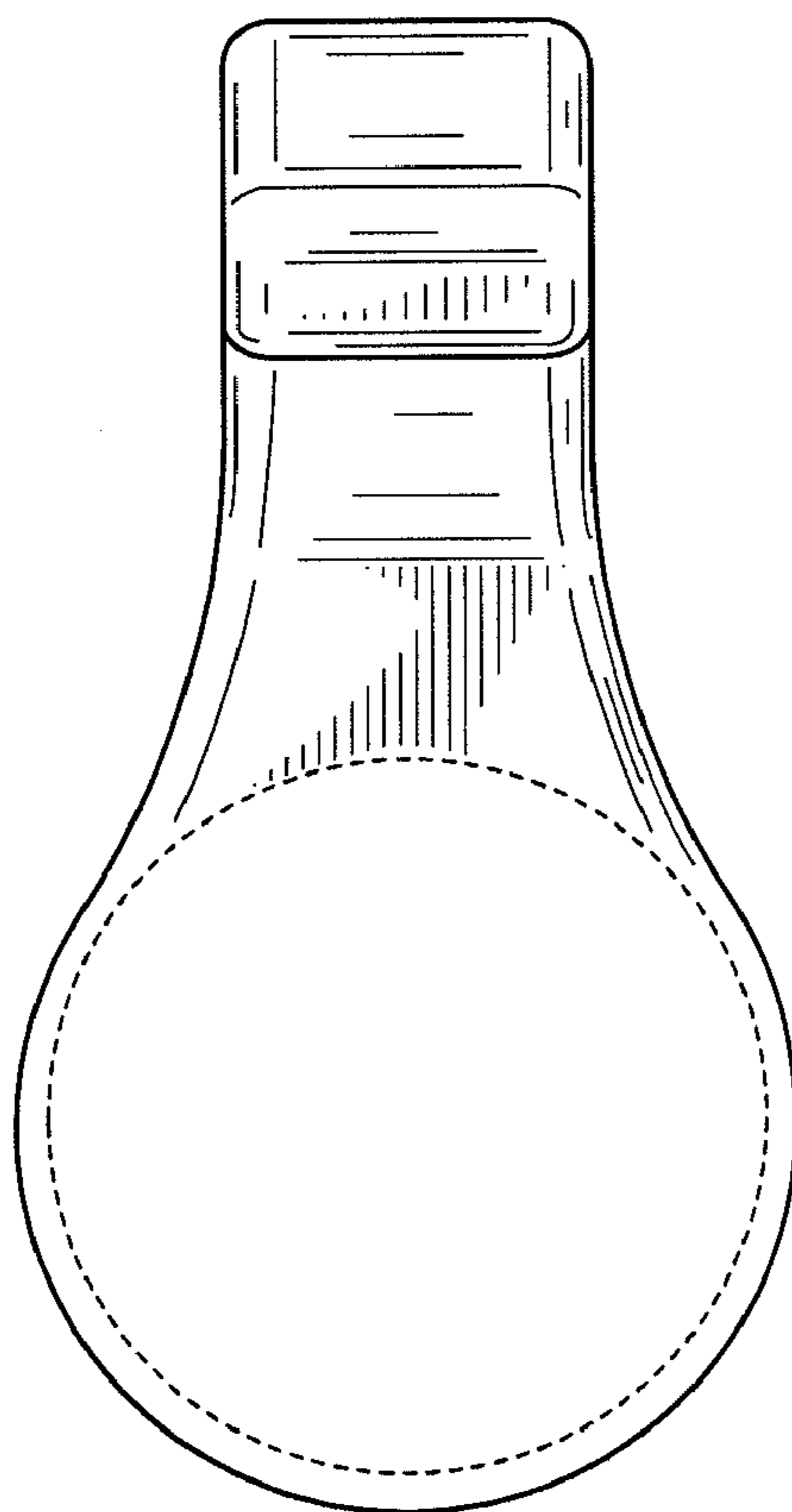

FIG. 12

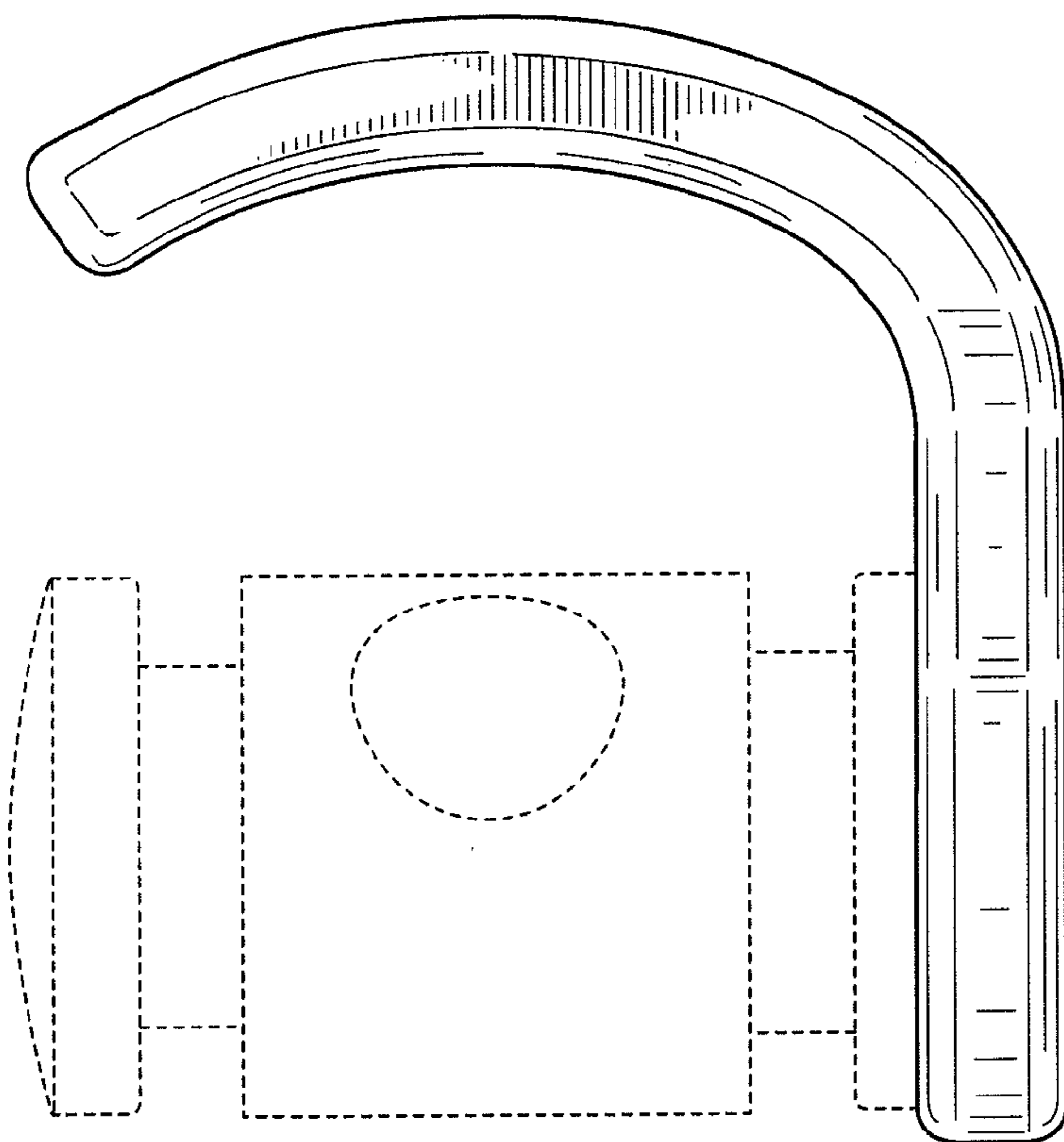

FIG. 13

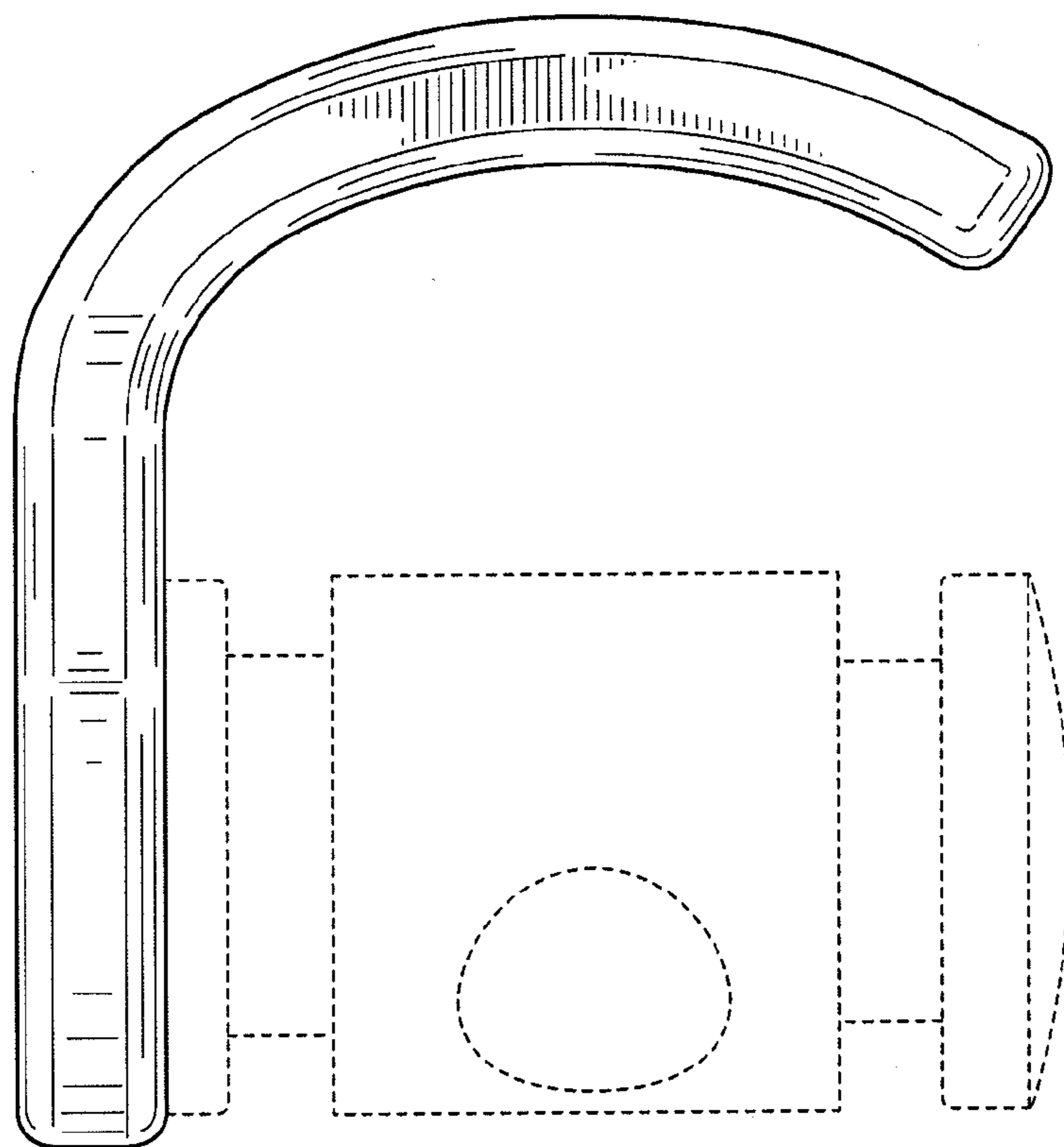

FIG. 14

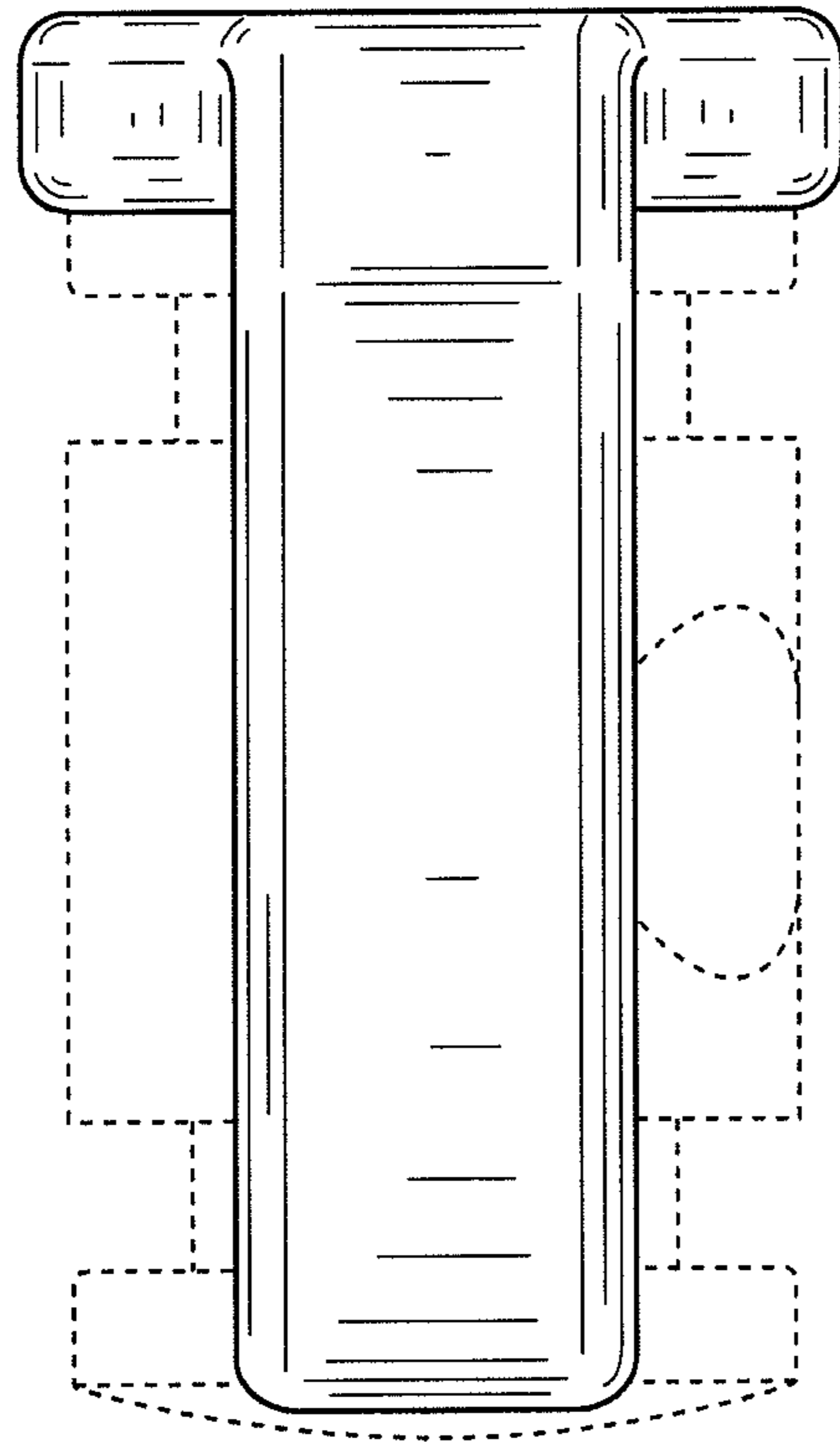

FIG. 15

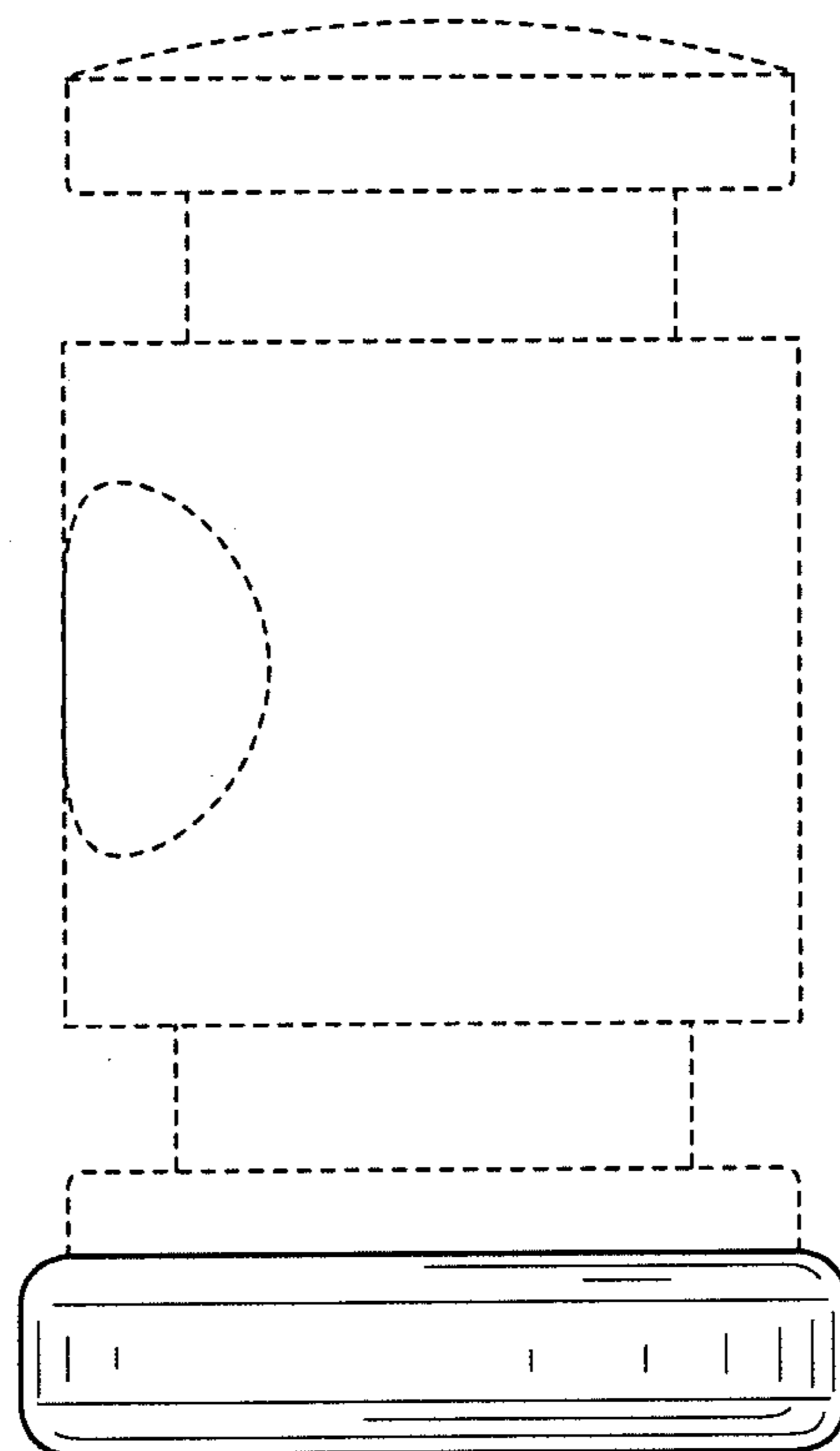

FIG. 16