



US00D671200S

(12) **United States Design Patent**  
**Kent et al.**

(10) **Patent No.:** **US D671,200 S**  
(45) **Date of Patent:** **\*\* Nov. 20, 2012**

(54) **FIREBOX**

(75) Inventors: **Jason Kent**, Guelph (CA); **Douglas G. Greenway**, Guelph (CA)

(73) Assignee: **Greenway Home Products Ltd.**, Guelph, Ontario (CA)

(\*\*) Term: **14 Years**

(21) Appl. No.: **29/395,224**

(22) Filed: **Dec. 20, 2011**

(51) **LOC (9) Cl.** ..... **23-03**

(52) **U.S. Cl.** ..... **D23/343**

(58) **Field of Classification Search** ..... D23/342,  
D23/351, 355, 378, 370, 381, 364, 336, 341,  
D23/343, 344; 126/547, 92 AC, 92 B, 91 R,  
126/200

See application file for complete search history.

(56) **References Cited**

**U.S. PATENT DOCUMENTS**

D264,497 S *	5/1982	Morande, Jr.	.....	D23/344
D301,610 S *	6/1989	Craver	.....	D23/344
D390,936 S *	2/1998	French et al.	.....	D23/350
D591,409 S *	4/2009	Kashimoto	.....	D23/351
D591,410 S *	4/2009	Kashimoto	.....	D23/351
7,726,299 B2 *	6/2010	Reyher	.....	126/512
D638,922 S *	5/2011	Zhou	.....	D23/344
D658,750 S *	5/2012	Nemes	.....	D23/344

\* cited by examiner

*Primary Examiner* — Eric Goodman

(74) *Attorney, Agent, or Firm* — Norton Rose Canada LLF

(57) **CLAIM**

The ornamental design for a firebox, as shown and described.

**DESCRIPTION**

FIG. 1 is a front perspective view of the firebox.

FIG. 2 is a back perspective view of the firebox.

FIG. 3 is a front plan view of the firebox.

FIG. 4 is a back plan view of the firebox.

FIG. 5 is a right plan view of the firebox.

FIG. 6 is a left plan view of the firebox.

FIG. 7 is a top plan view of the firebox.

FIG. 8 is a bottom plan view of the firebox.

In accordance with a second variant of the present design:

FIG. 9 is a front perspective view of the firebox.

FIG. 10 is a back perspective view of the firebox.

FIG. 11 is a front plan view of the firebox.

FIG. 12 is a back plan view of the firebox.

FIG. 13 is a right plan view of the firebox.

FIG. 14 is a left plan view of the firebox.

FIG. 15 is a top plan view of the firebox.

FIG. 16 is a bottom plan view of the firebox.

In accordance with a third variant of the present design:

FIG. 17 is a front perspective view of the firebox.

FIG. 18 is a back perspective view of the firebox.

FIG. 19 is a front plan view of the firebox.

FIG. 20 is a back plan view of the firebox.

FIG. 21 is a right plan view of the firebox.

FIG. 22 is a left plan view of the firebox.

FIG. 23 is a top plan view of the firebox.

FIG. 24 is a bottom plan view of the firebox.

In accordance with a fourth variant of the present design:

FIG. 25 is a front perspective view of the firebox.

FIG. 26 is a back perspective view of the firebox.

FIG. 27 is a front plan view of the firebox.

FIG. 28 is a back plan view of the firebox.

FIG. 29 is a right plan view of the firebox.

FIG. 30 is a left plan view of the firebox.

FIG. 31 is a top plan view of the firebox.

FIG. 32 is a bottom plan view of the firebox.

In accordance with a fifth variant of the present design:

FIG. 33 is a front perspective view of the firebox.

FIG. 34 is a back perspective view of the firebox.

FIG. 35 is a front plan view of the firebox.

FIG. 36 is a back plan view of the firebox.

FIG. 37 is a right plan view of the firebox.

FIG. 38 is a left plan view of the firebox.

FIG. 39 is a top plan view of the firebox.

FIG. 40 is a bottom plan view of the firebox.

In accordance with a sixth variant of the present design:

FIG. 41 is a front perspective view of the firebox.

FIG. 42 is a back perspective view of the firebox.

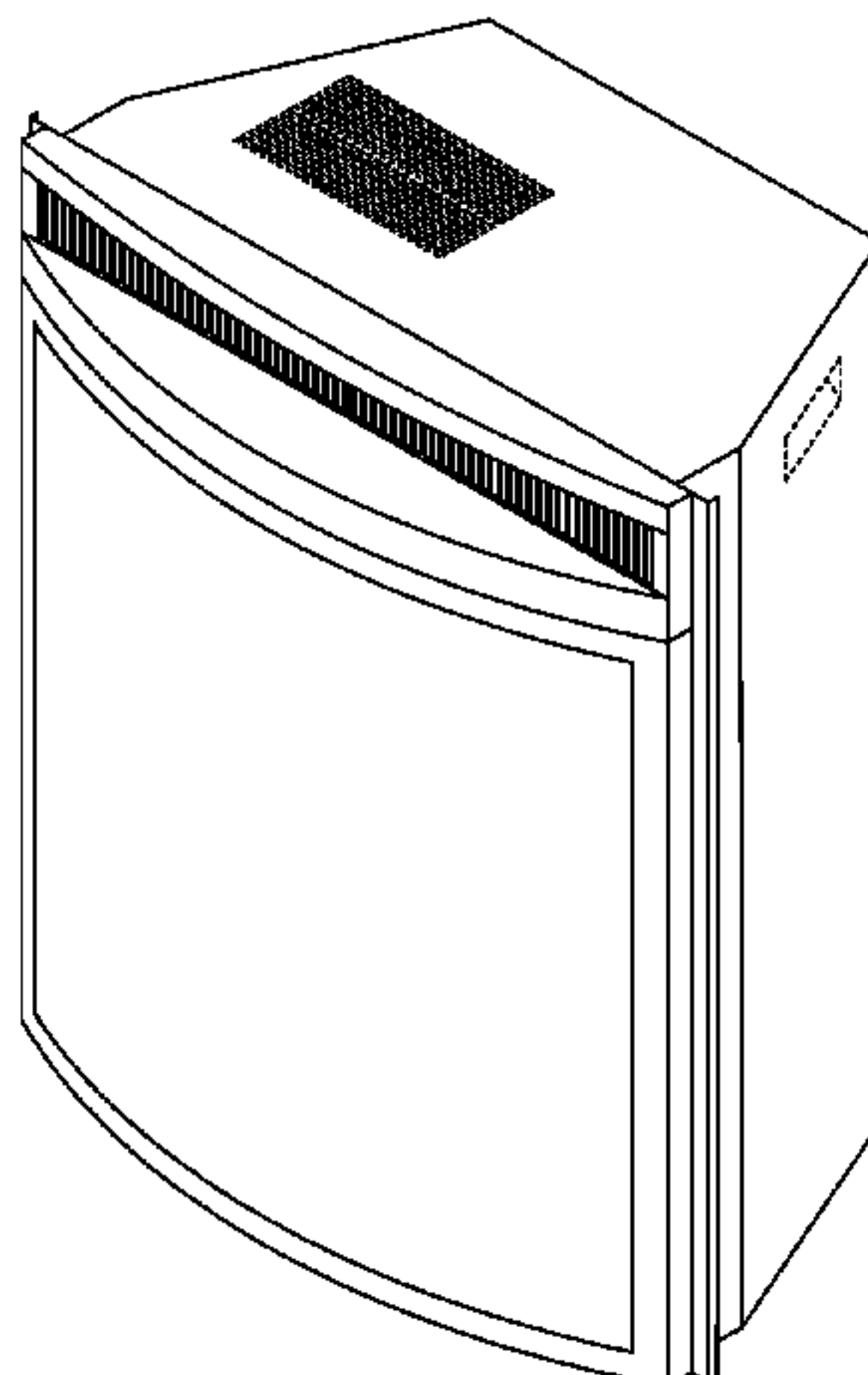

FIG. 43 is a front plan view of the firebox.

FIG. 44 is a back plan view of the firebox.

FIG. 45 is a right plan view of the firebox.

FIG. 46 is a left plan view of the firebox.

FIG. 47 is a top plan view of the firebox.

FIG. 48 is a bottom plan view of the firebox.

In accordance with a seventh variant of the present design:

FIG. 49 is a front perspective view of the firebox.

FIG. 50 is a back perspective view of the firebox.

FIG. 51 is a front plan view of the firebox.

FIG. 52 is a back plan view of the firebox.

FIG. 53 is a right plan view of the firebox.

FIG. 54 is a left plan view of the firebox.

FIG. 55 is a top plan view of the firebox.

FIG. 56 is a bottom plan view of the firebox.

In accordance with an eighth variant of the present design:

FIG. 57 is a front perspective view of the firebox.

FIG. 58 is a back perspective view of the firebox.

FIG. 59 is a front plan view of the firebox.

FIG. 60 is a back plan view of the firebox.

FIG. 61 is a right plan view of the firebox.

FIG. 62 is a left plan view of the firebox.

FIG. 63 is a top plan view of the firebox.

FIG. 64 is a bottom plan view of the firebox.

In accordance with a ninth variant of the present design:

FIG. 65 is a front perspective view of the firebox.

FIG. 66 is a back perspective view of the firebox.

FIG. 67 is a front plan view of the firebox.

FIG. 68 is a back plan view of the firebox.

FIG. 69 is a right plan view of the firebox.

FIG. 70 is a left plan view of the firebox.

FIG. 71 is a top plan view of the firebox.

FIG. 72 is a bottom plan view of the firebox.

In accordance with a tenth variant of the present design:

FIG. 73 is a front perspective view of the firebox.

FIG. 74 is a back perspective view of the firebox.

FIG. 75 is a front plan view of the firebox.

FIG. 76 is a back plan view of the firebox.

FIG. 77 is a right plan view of the firebox.

FIG. 78 is a left plan view of the firebox.

FIG. 79 is a top plan view of the firebox.

FIG. 80 is a bottom plan view of the firebox.

In accordance with an eleventh variant of the present design:

FIG. 81 is a front perspective view of the firebox.

FIG. 82 is a back perspective view of the firebox.

FIG. 83 is a front plan view of the firebox.

FIG. 84 is a back plan view of the firebox.

FIG. 85 is a right plan view of the firebox.

FIG. 86 is a left plan view of the firebox.

FIG. 87 is a top plan view of the firebox; and,

FIG. 88 is a bottom plan view of the firebox.

The broken line showing is included for the purpose of illustrating portions of the article and forms no part of the claimed design.

**1 Claim, 88 Drawing Sheets**

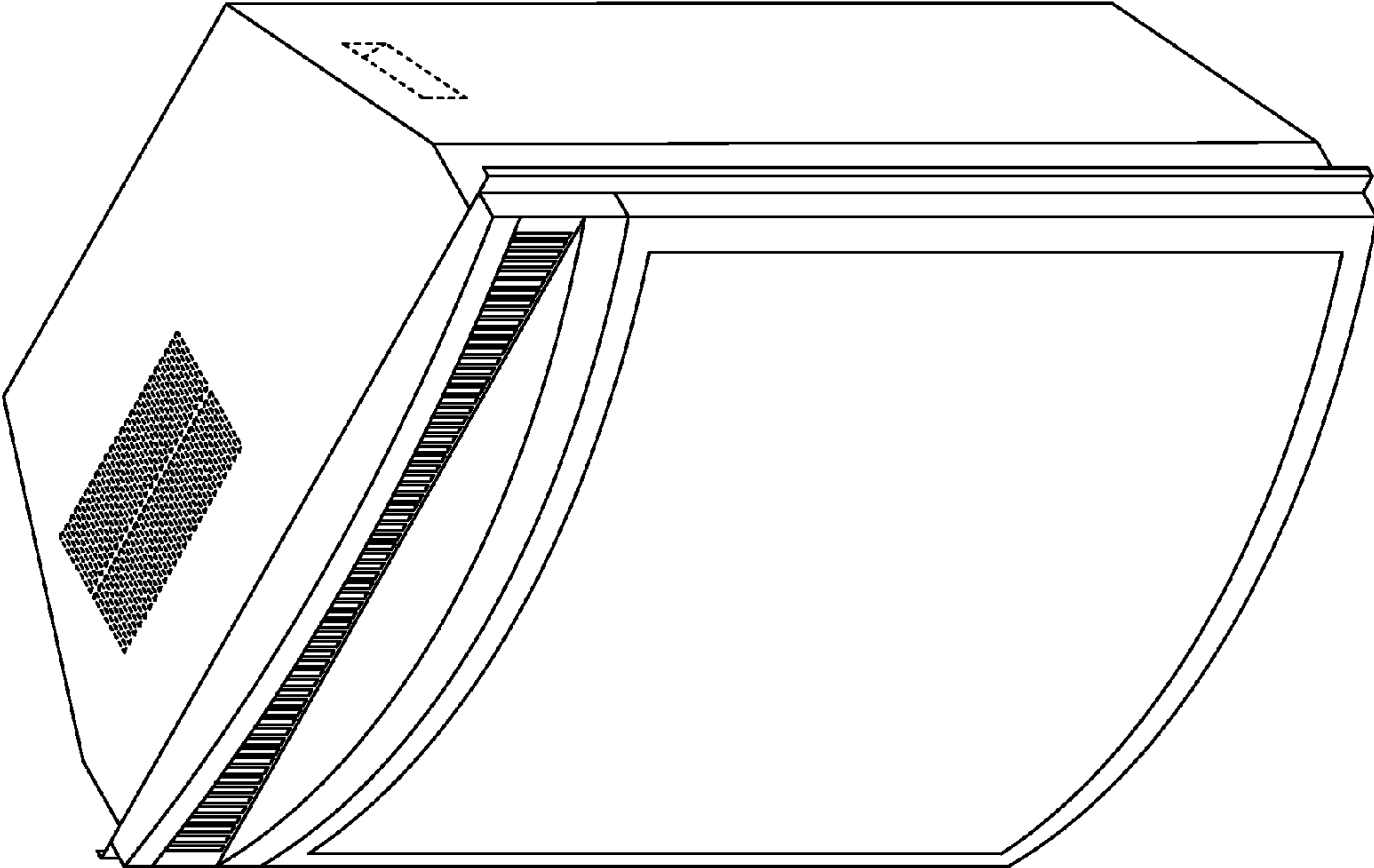

FIG.1

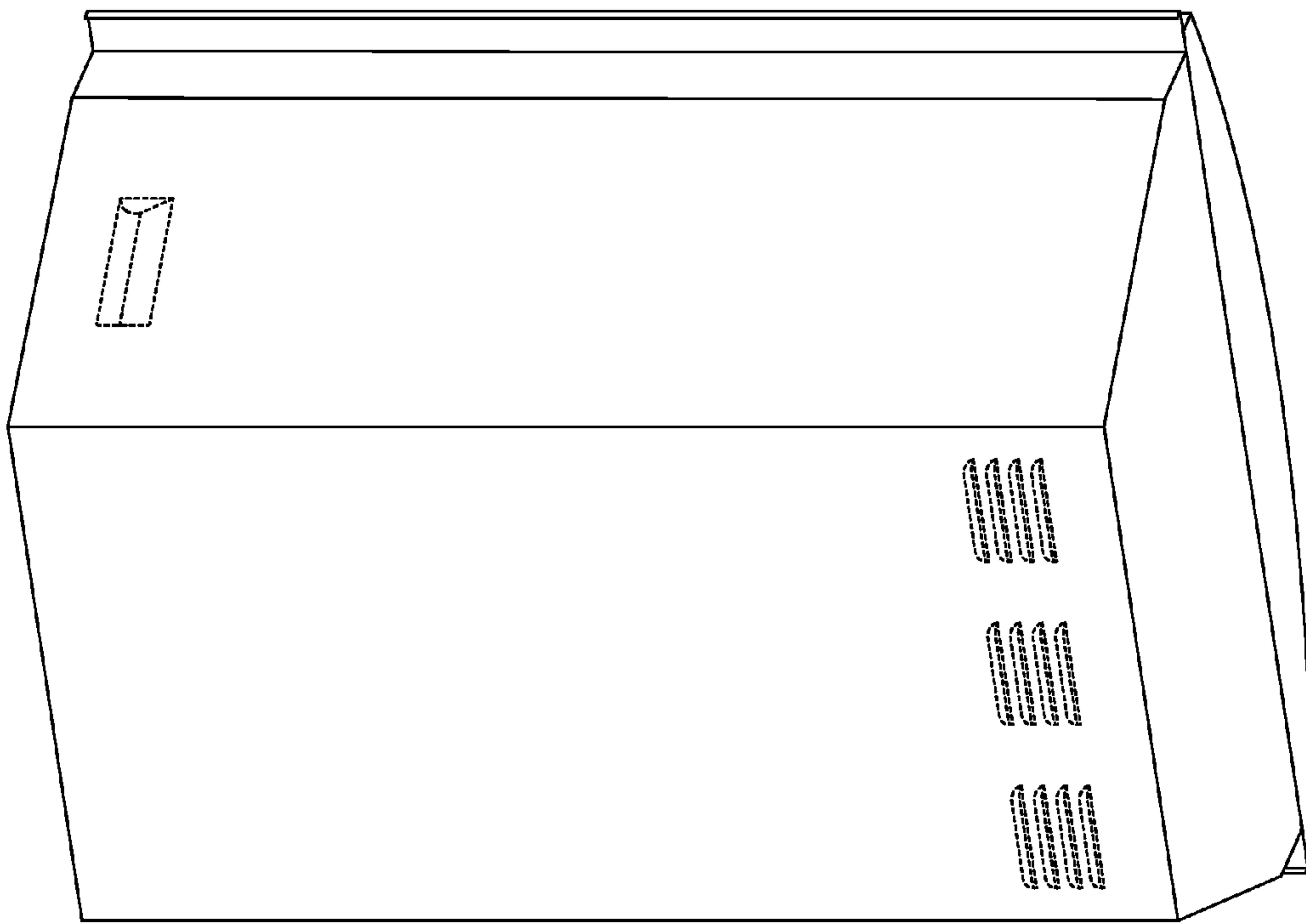

FIG.2

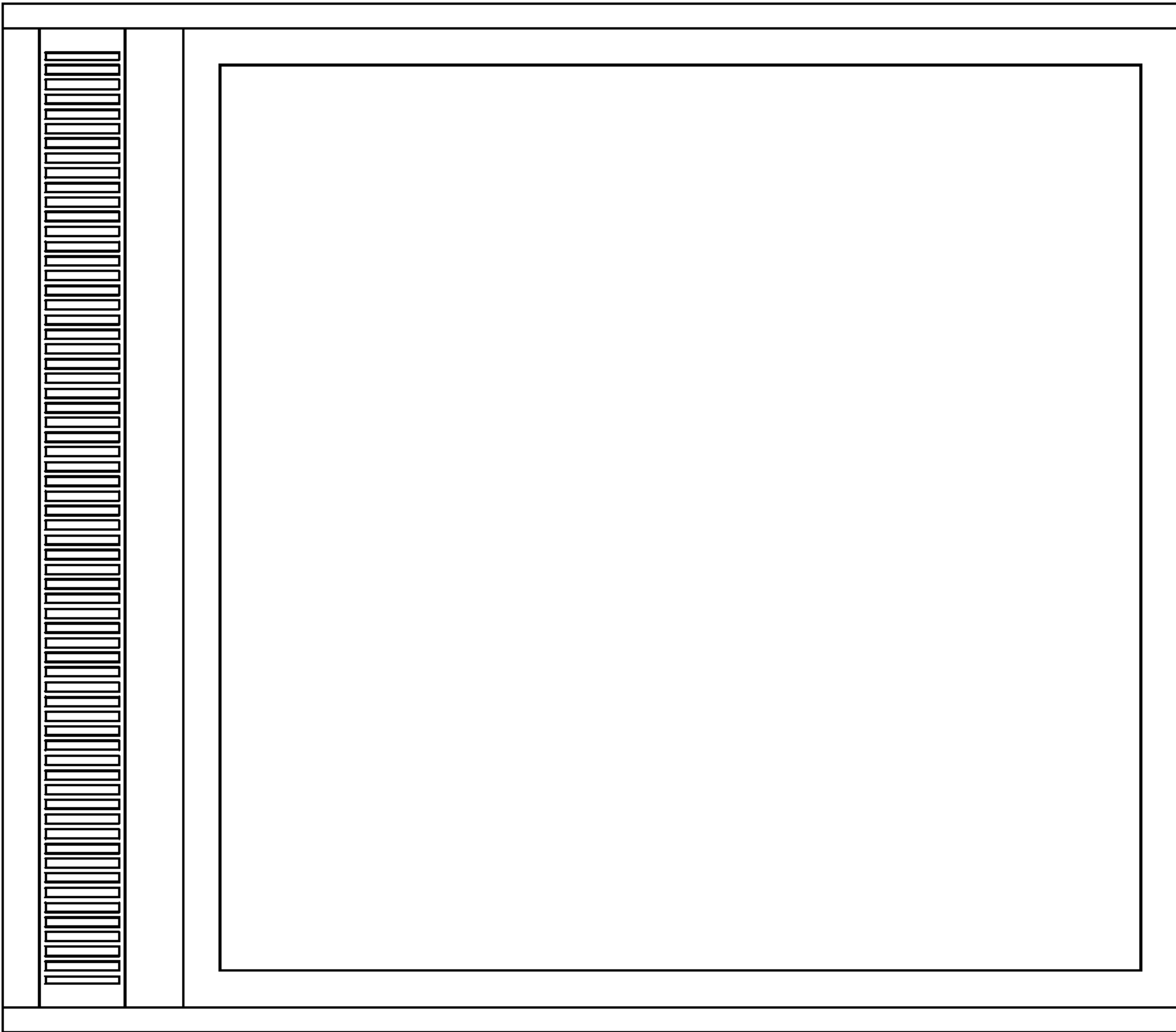

FIG.3

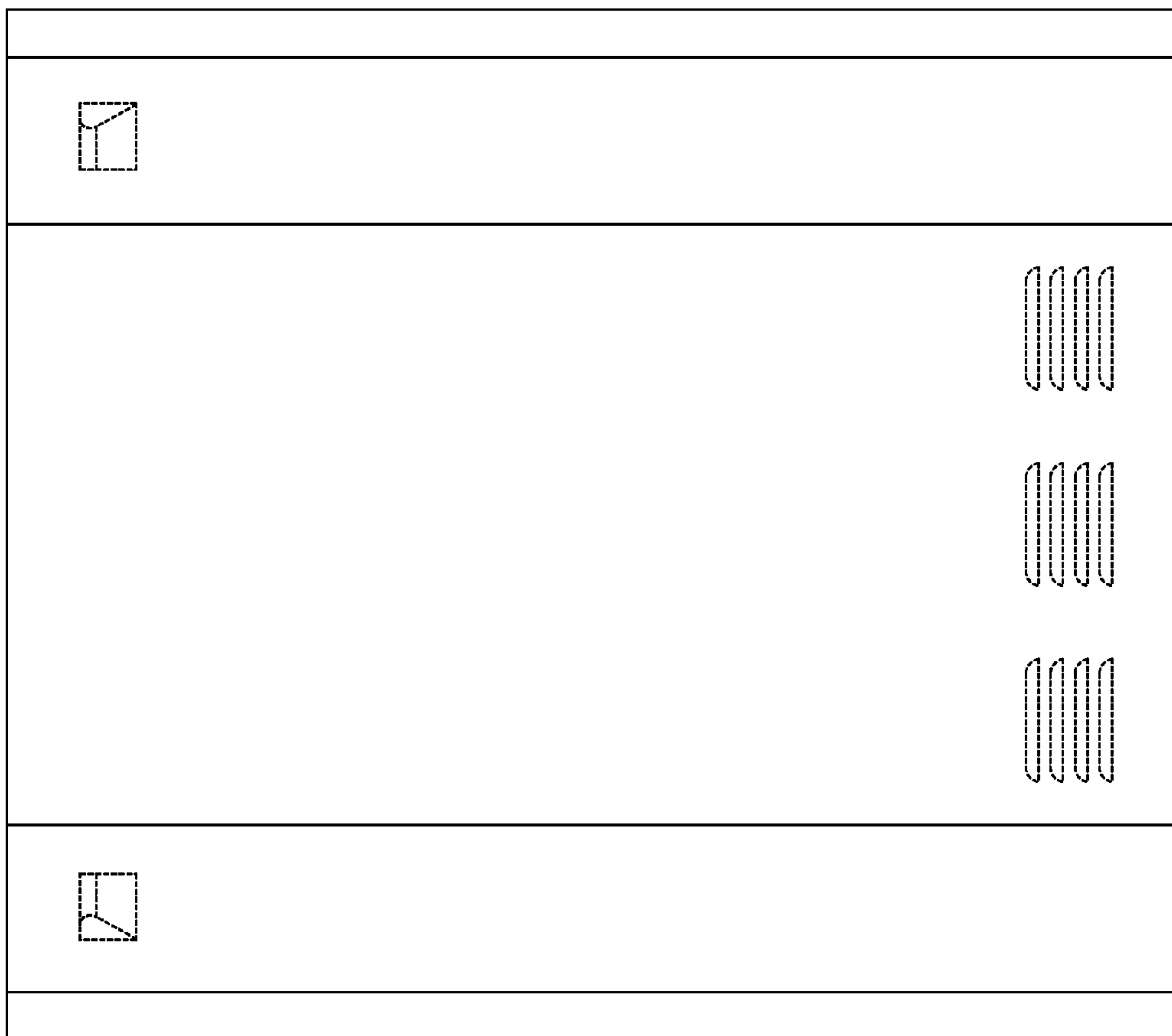

FIG.4



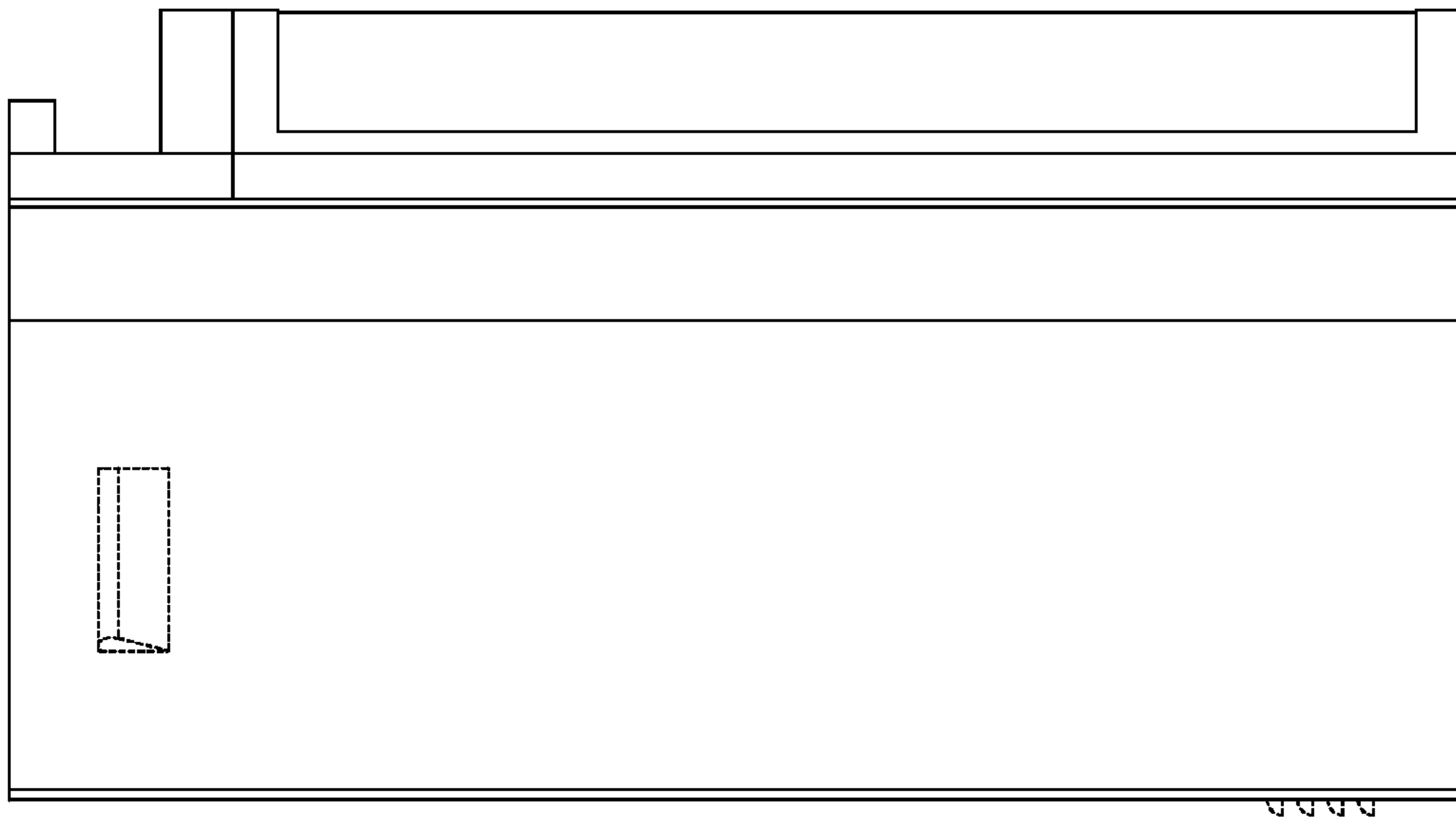

FIG.5

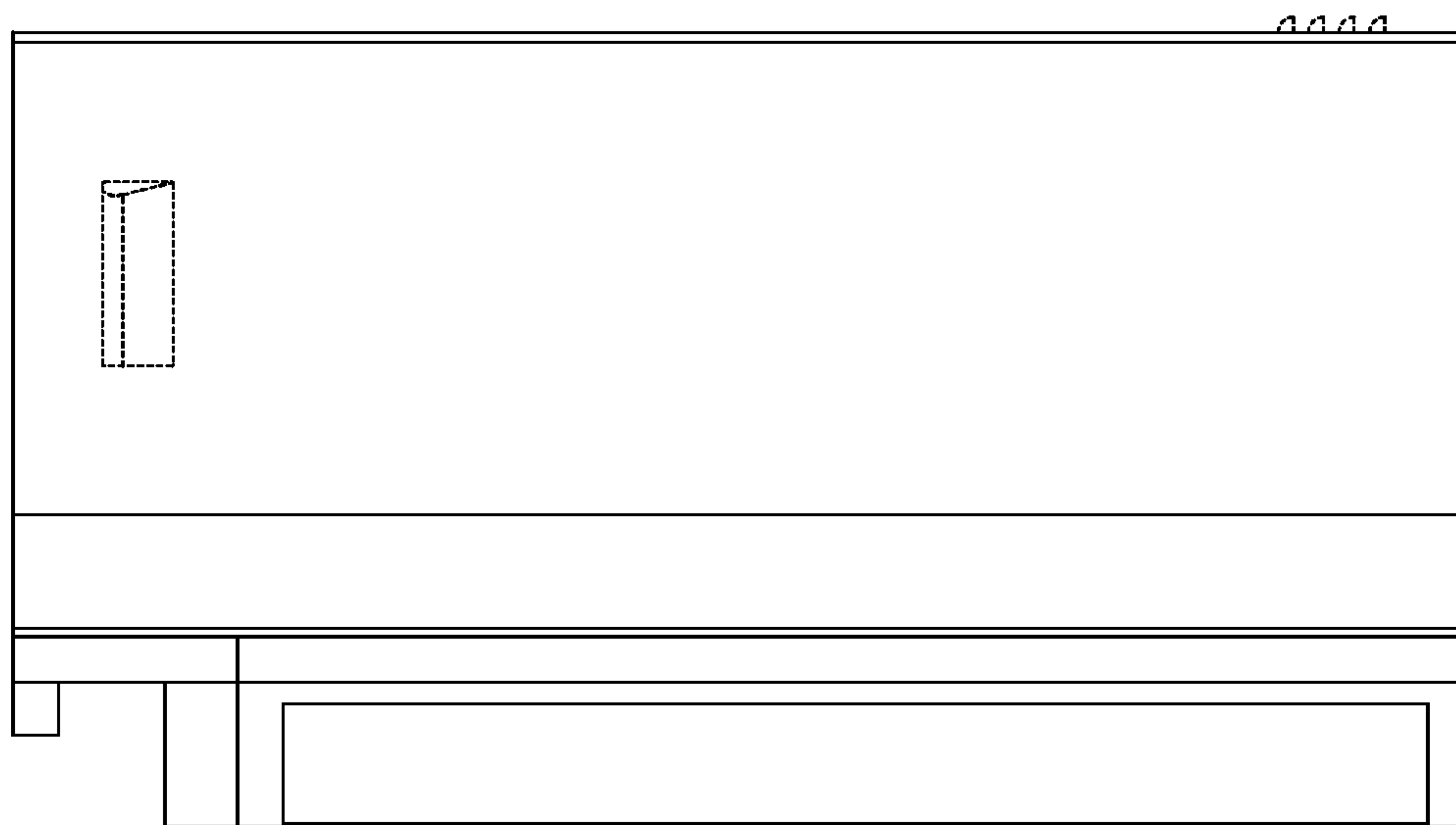

FIG.6



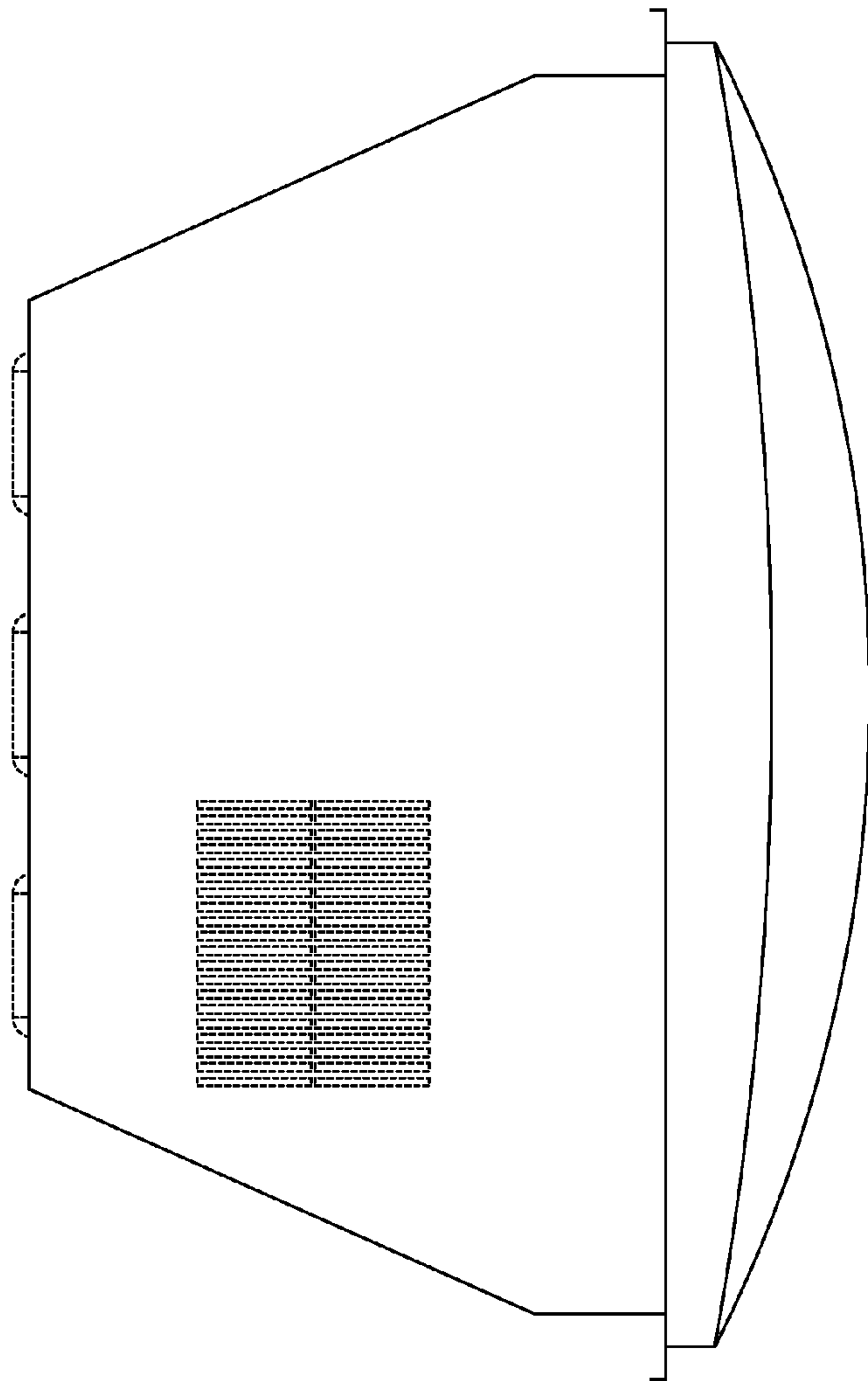

FIG. 7

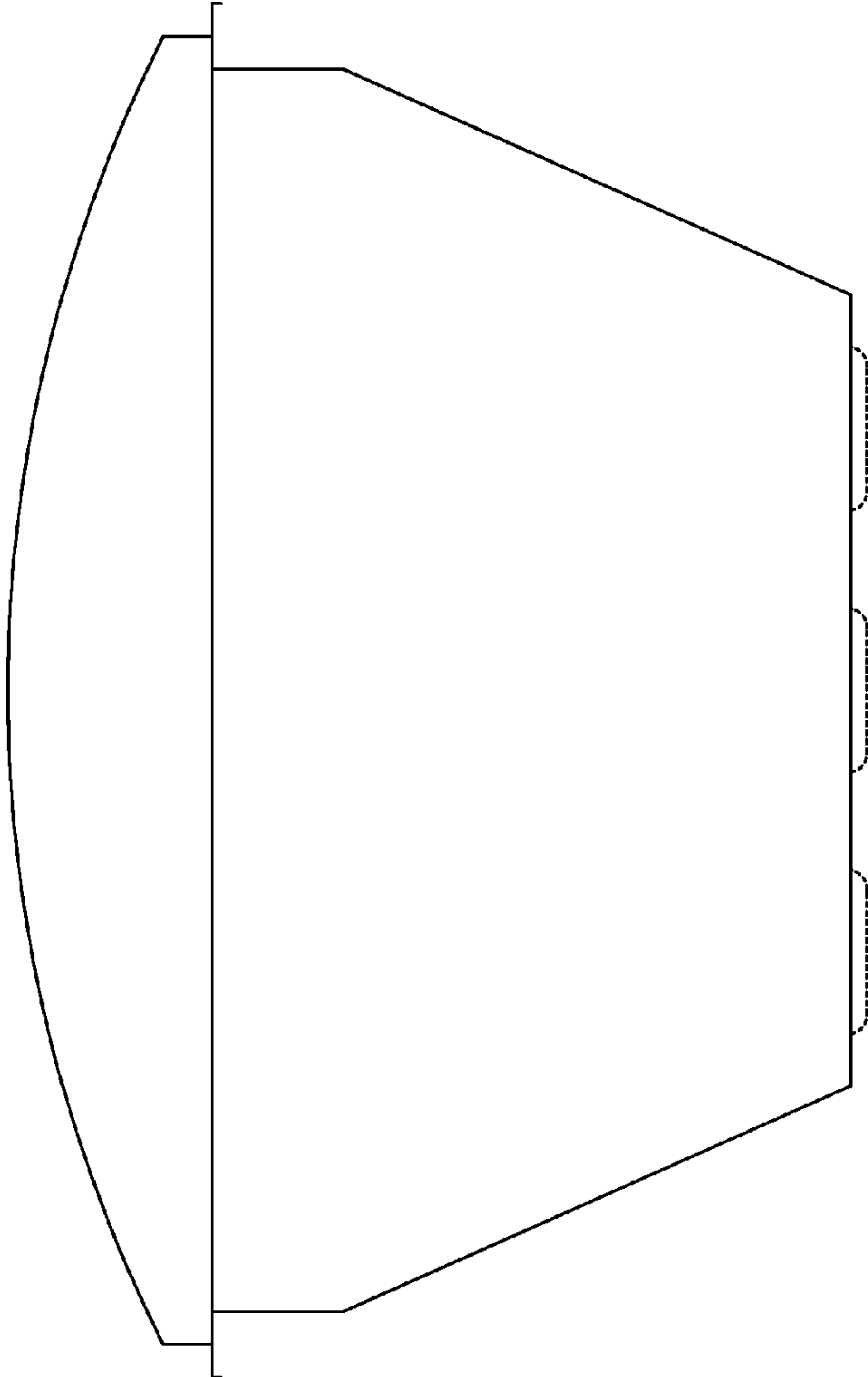

FIG. 8

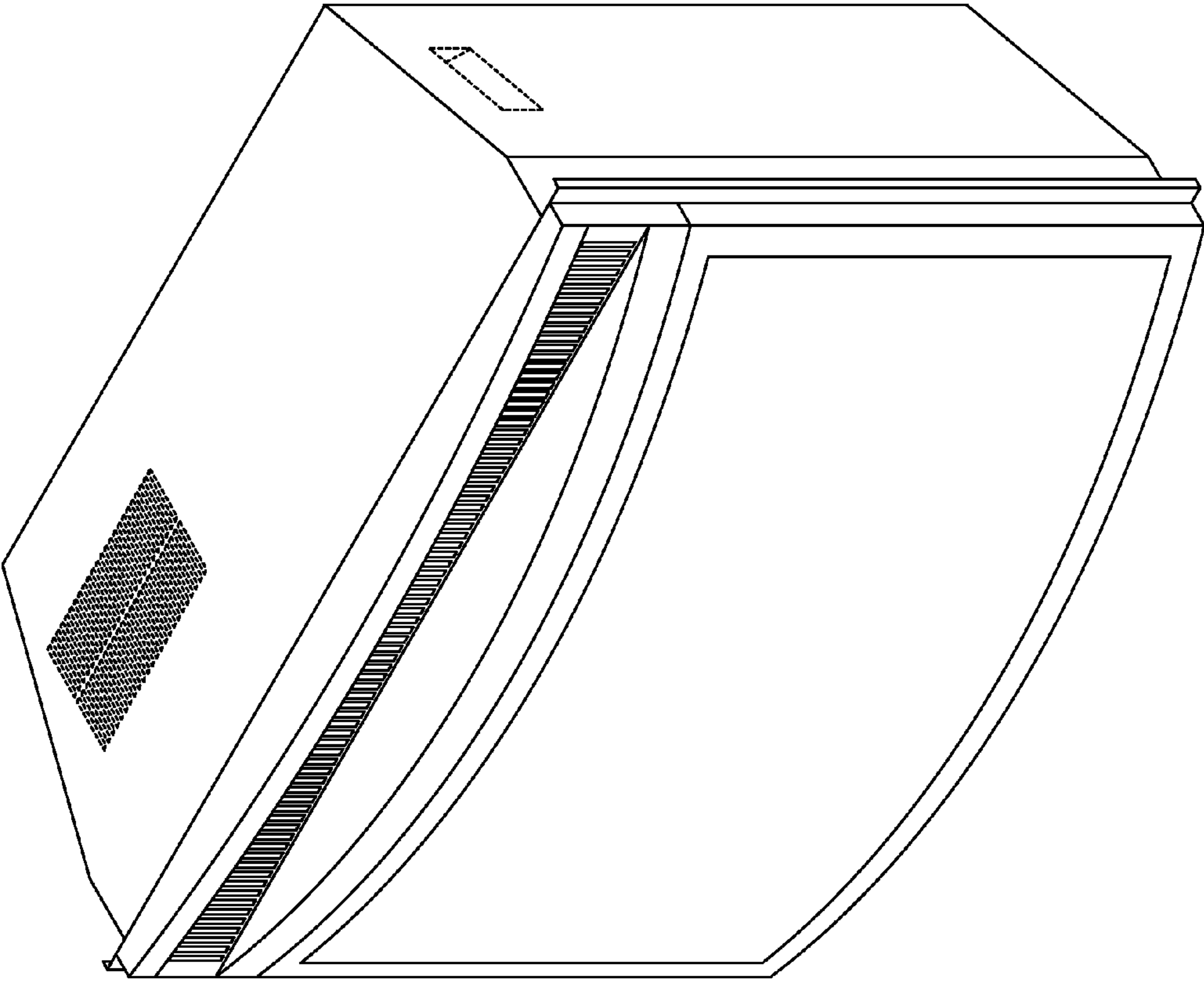

FIG.9

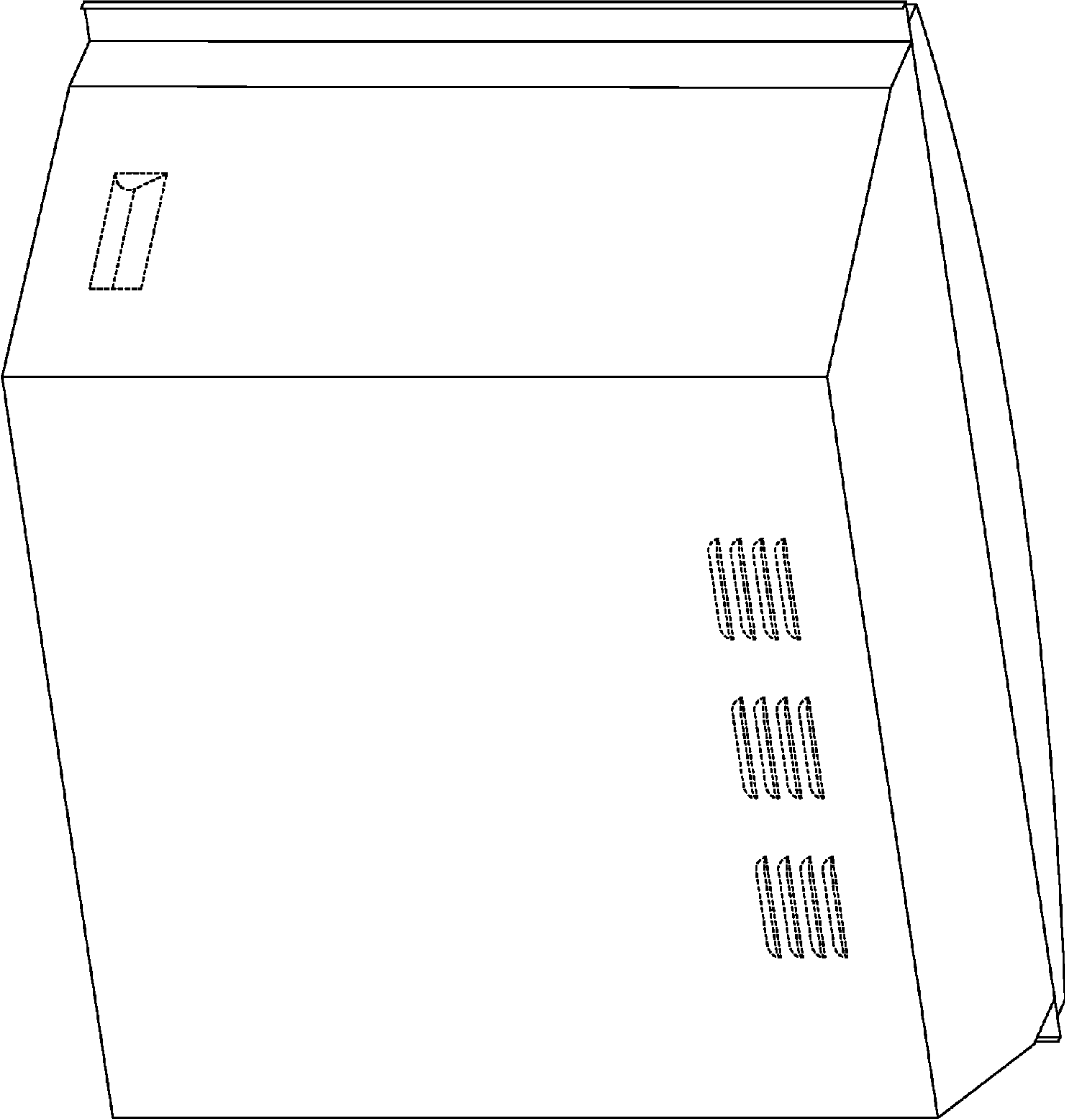

FIG.10

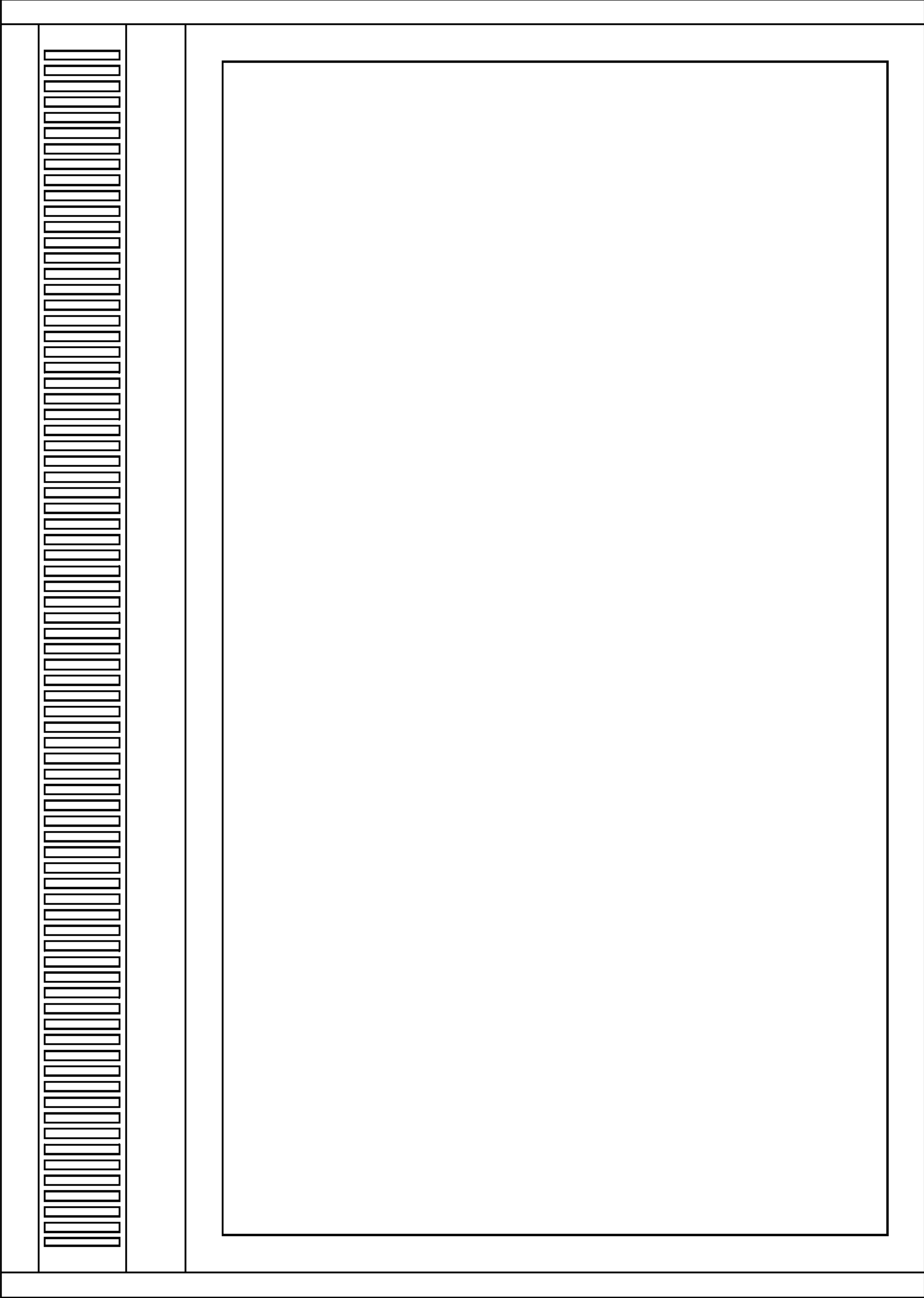

FIG.11

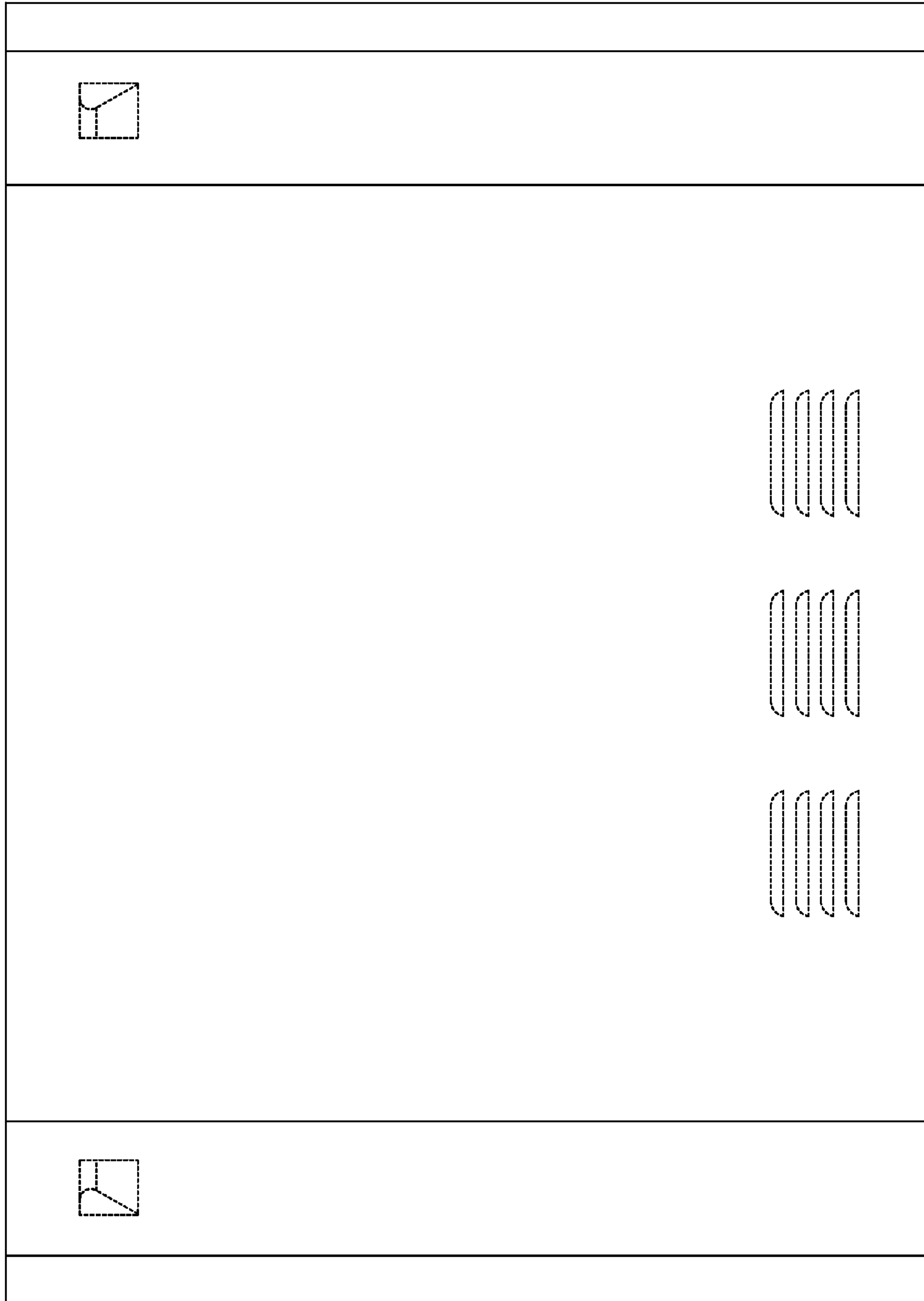

FIG.12

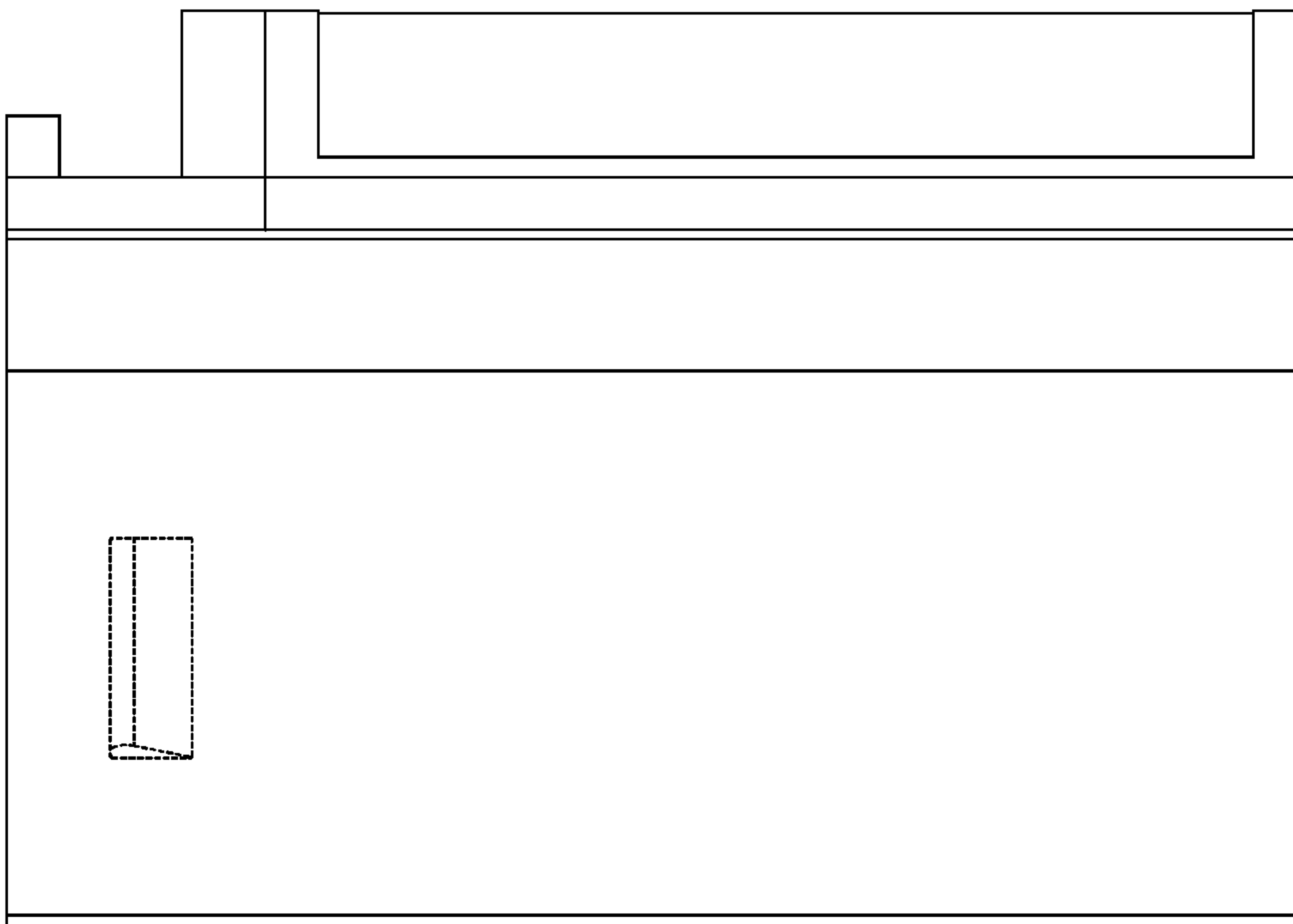

FIG.13

FIG.13



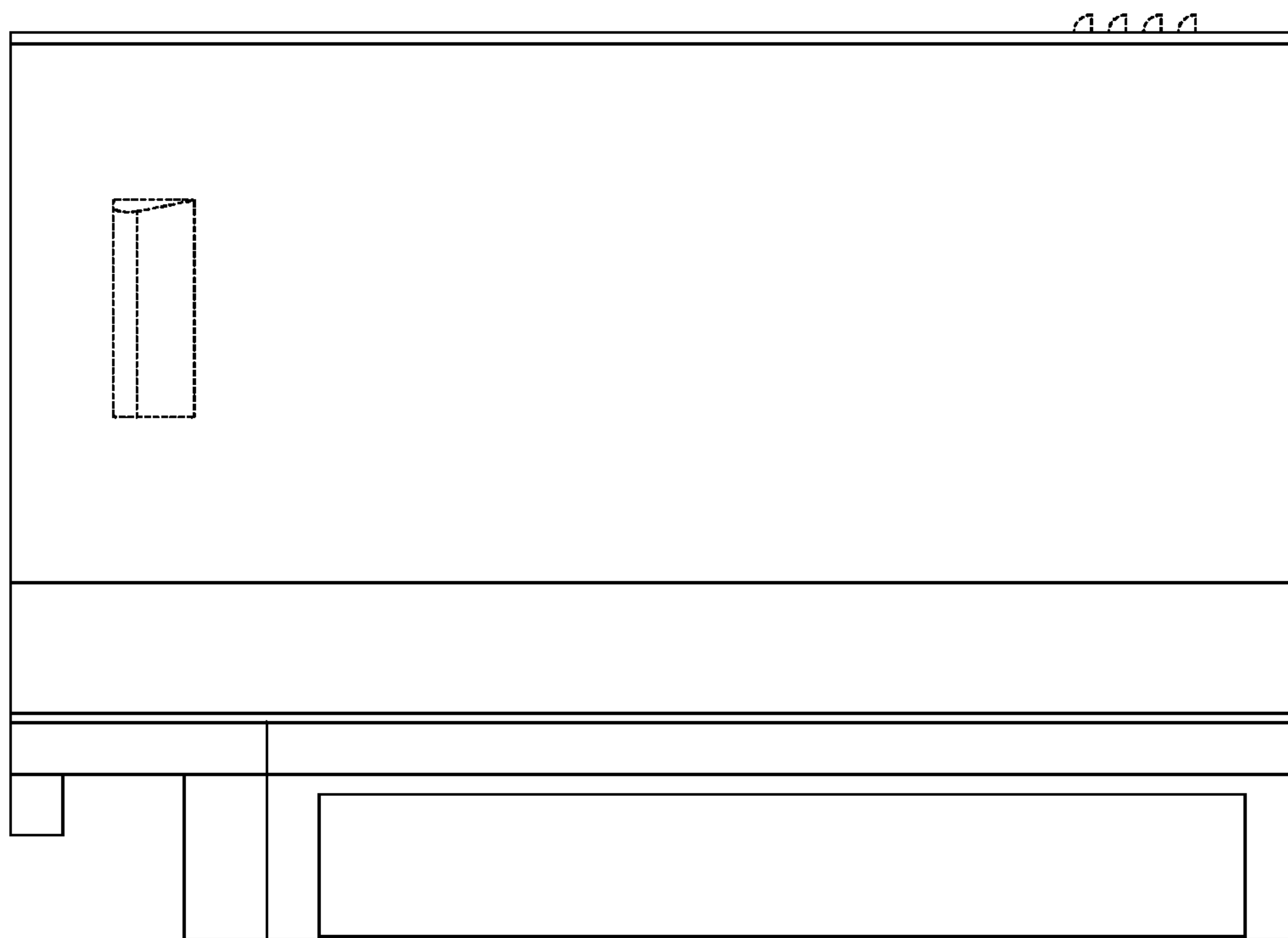

FIG.14

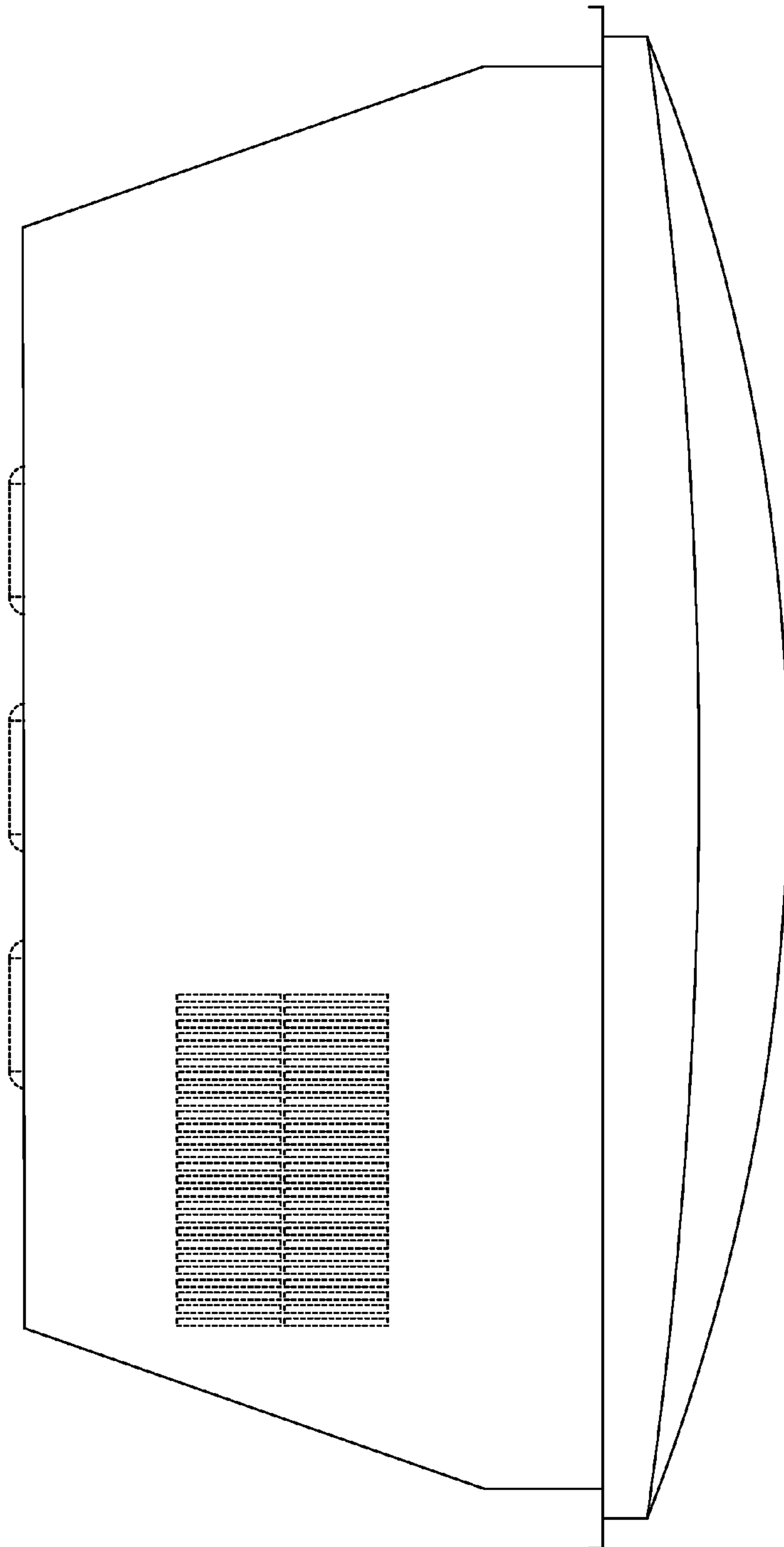

FIG.15

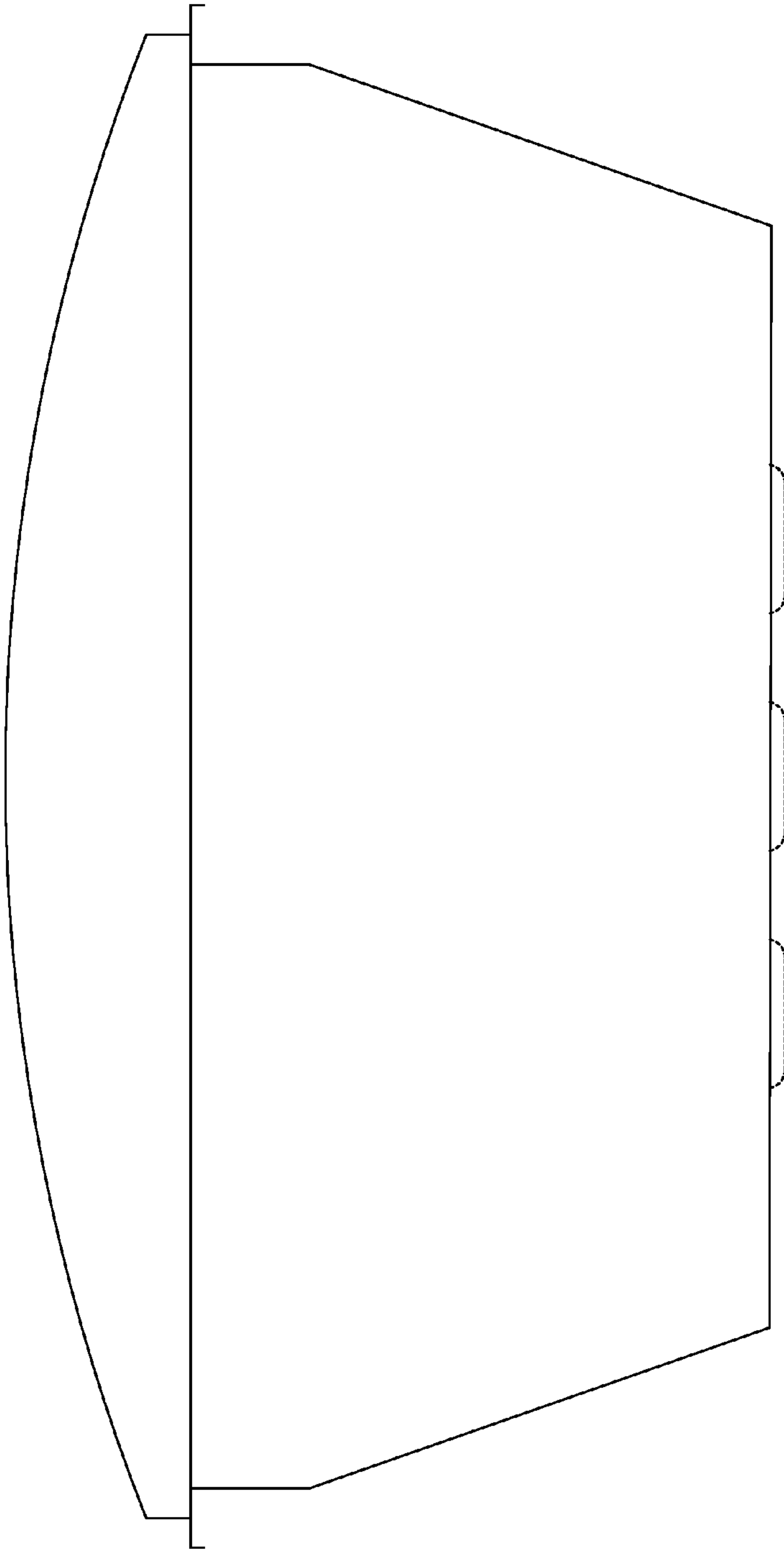

FIG.16

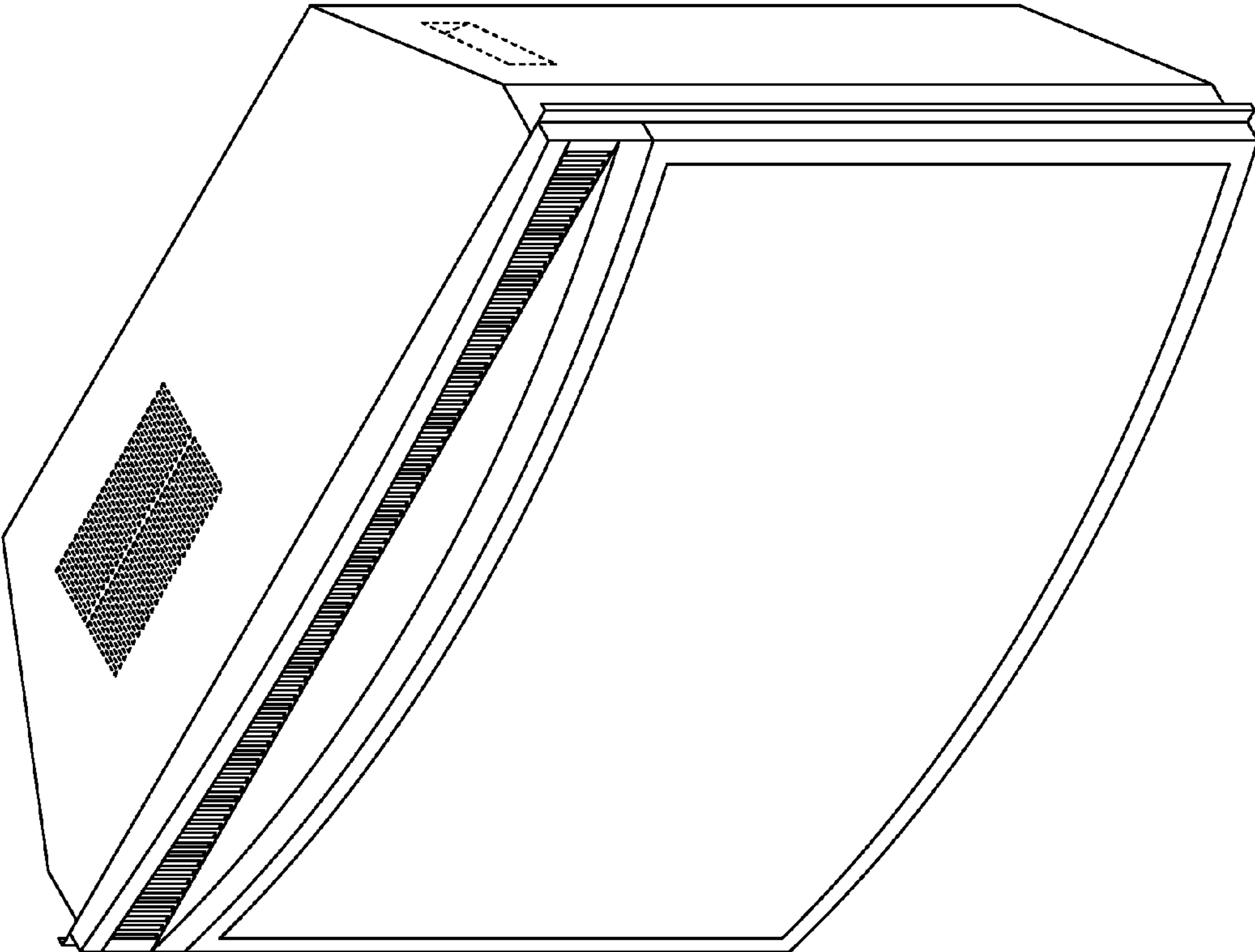

FIG.17

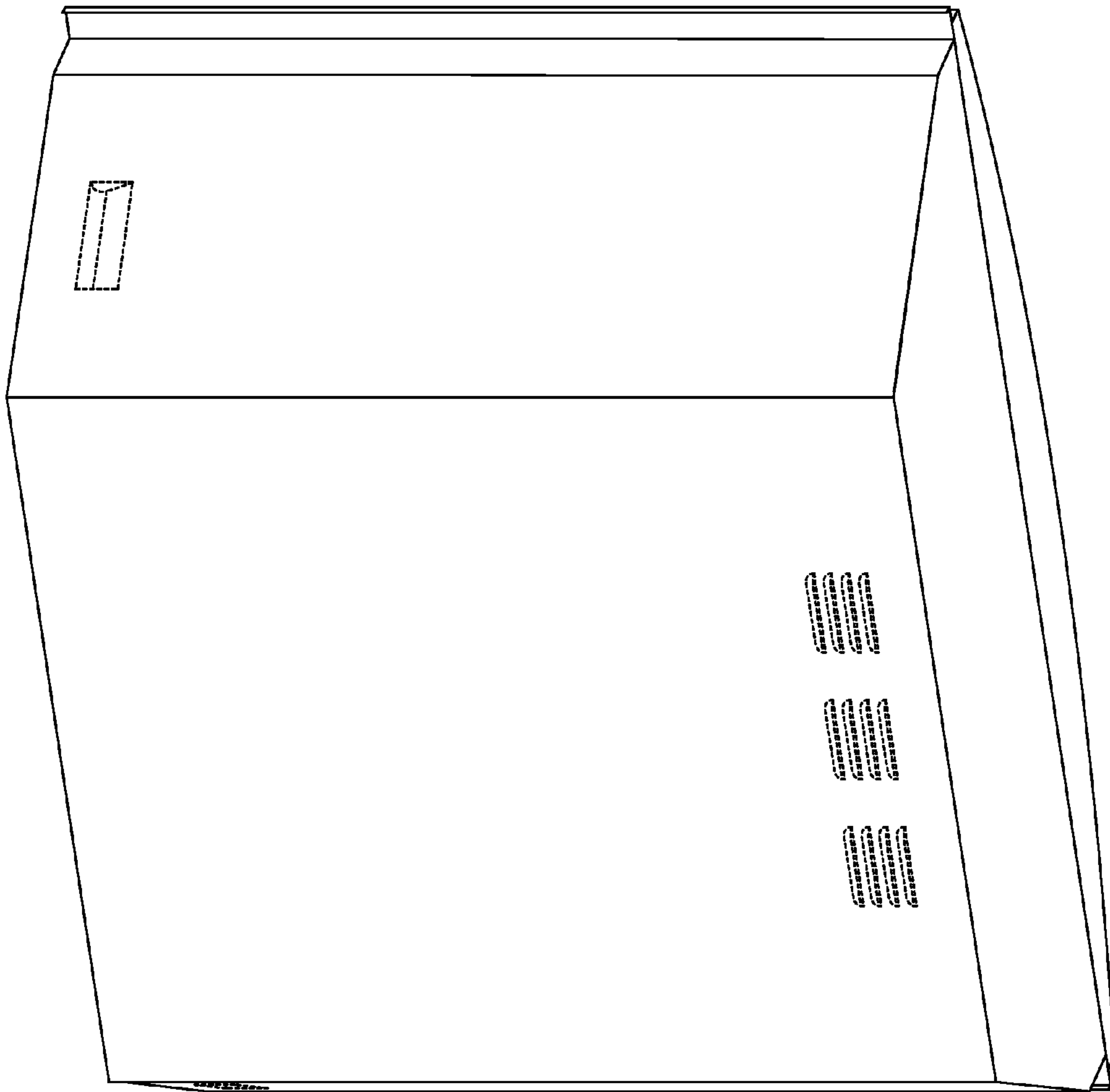

FIG.18

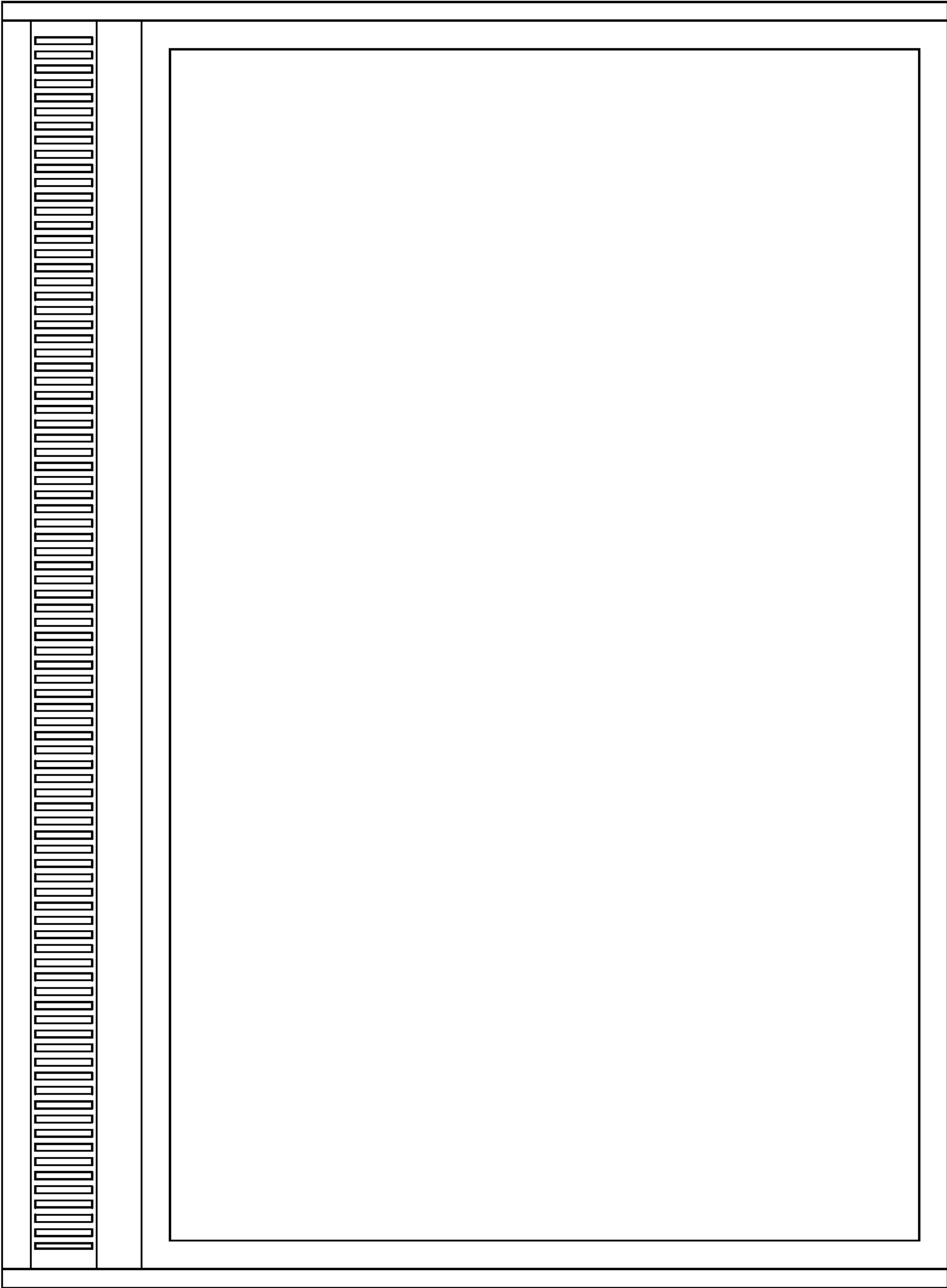

FIG.19

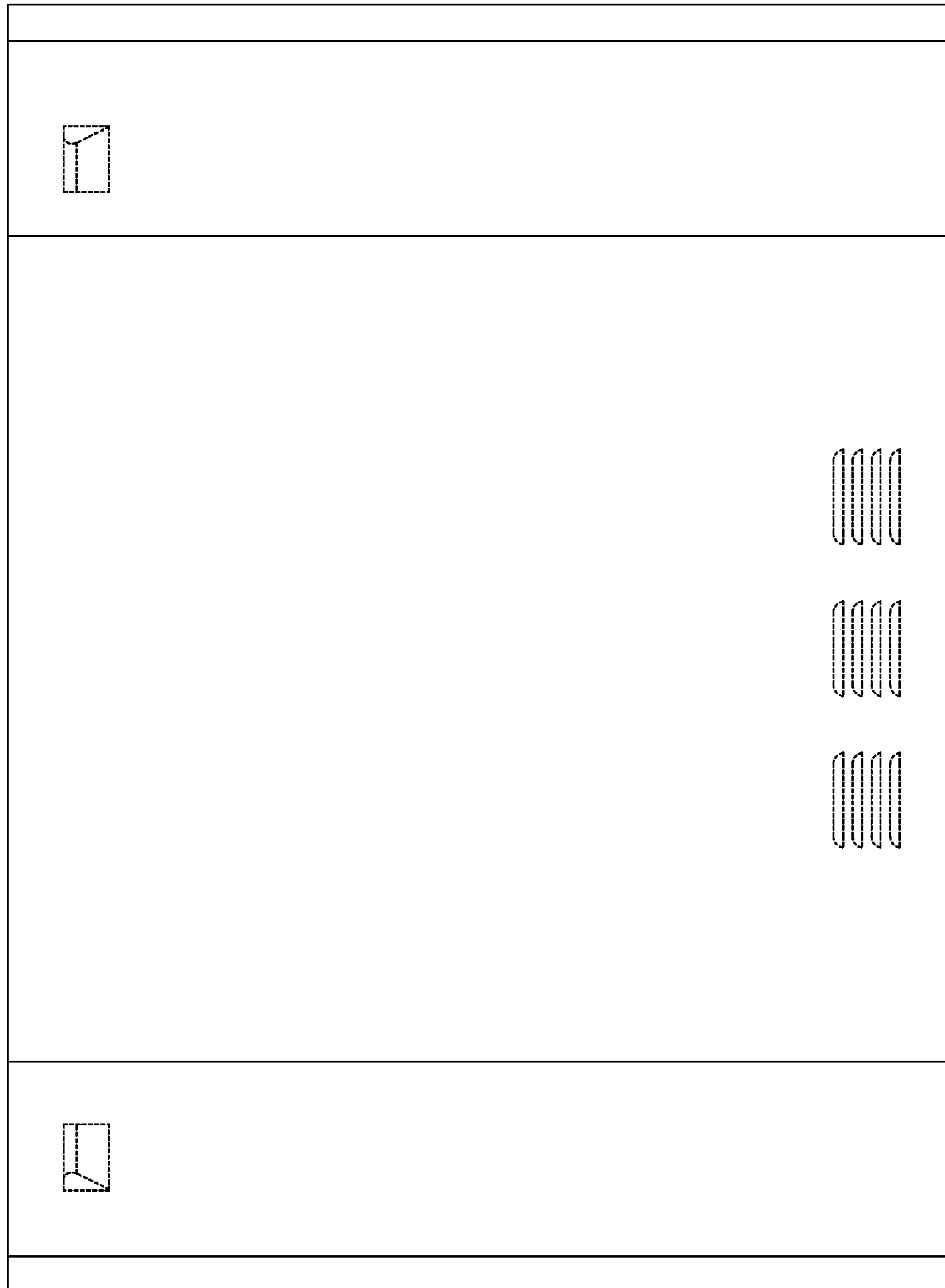

FIG.20



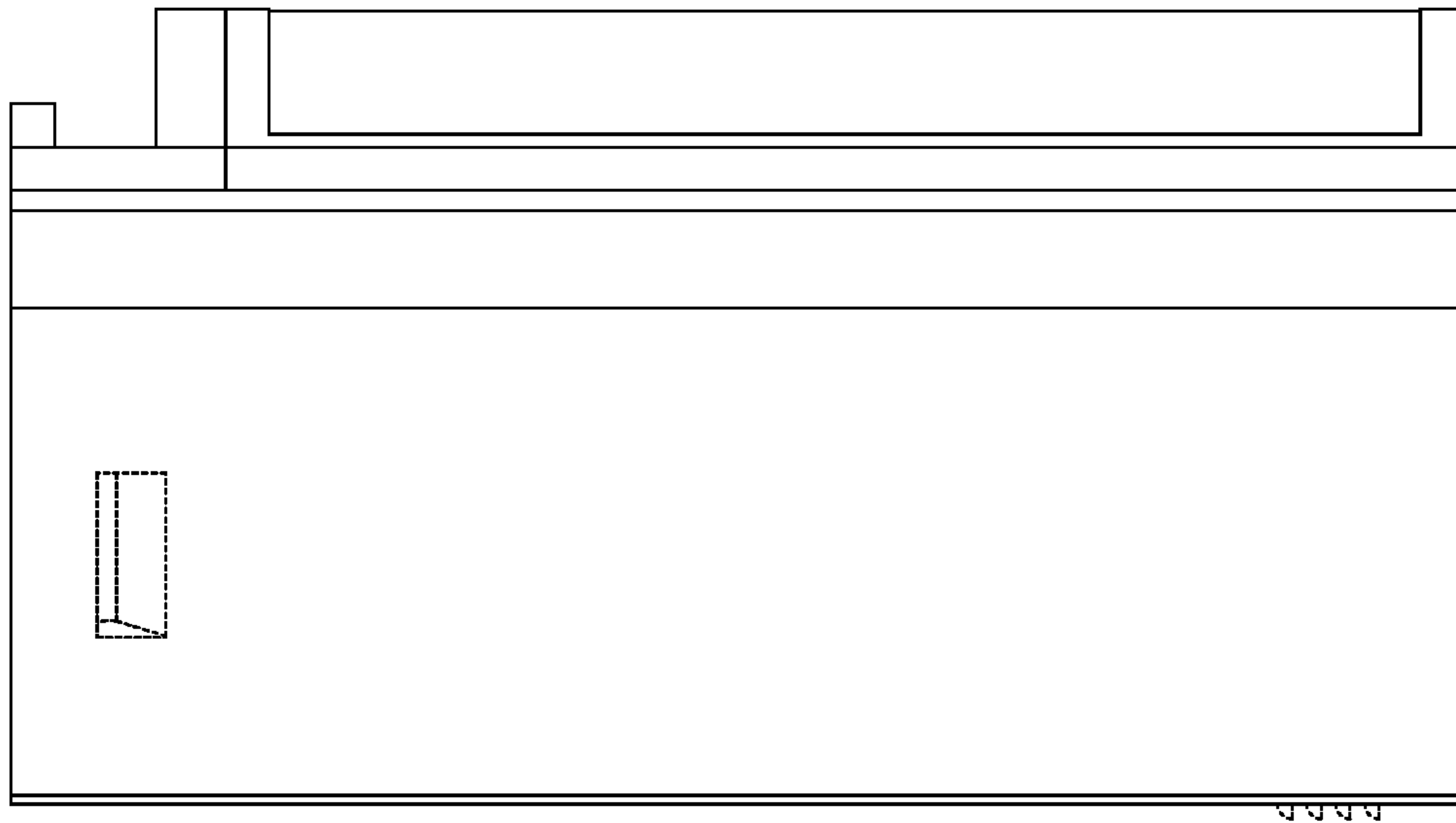

FIG.21

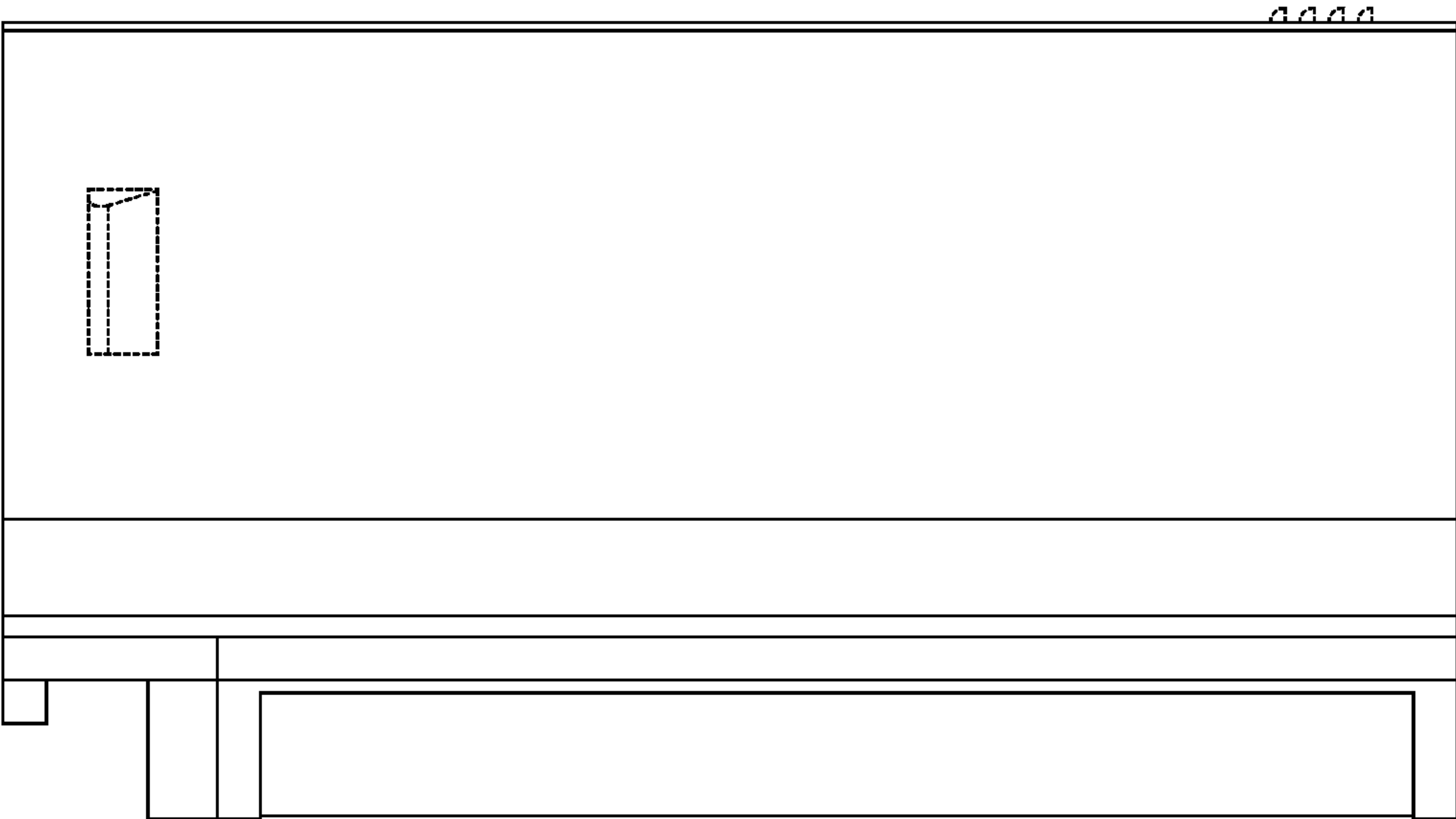

FIG. 22

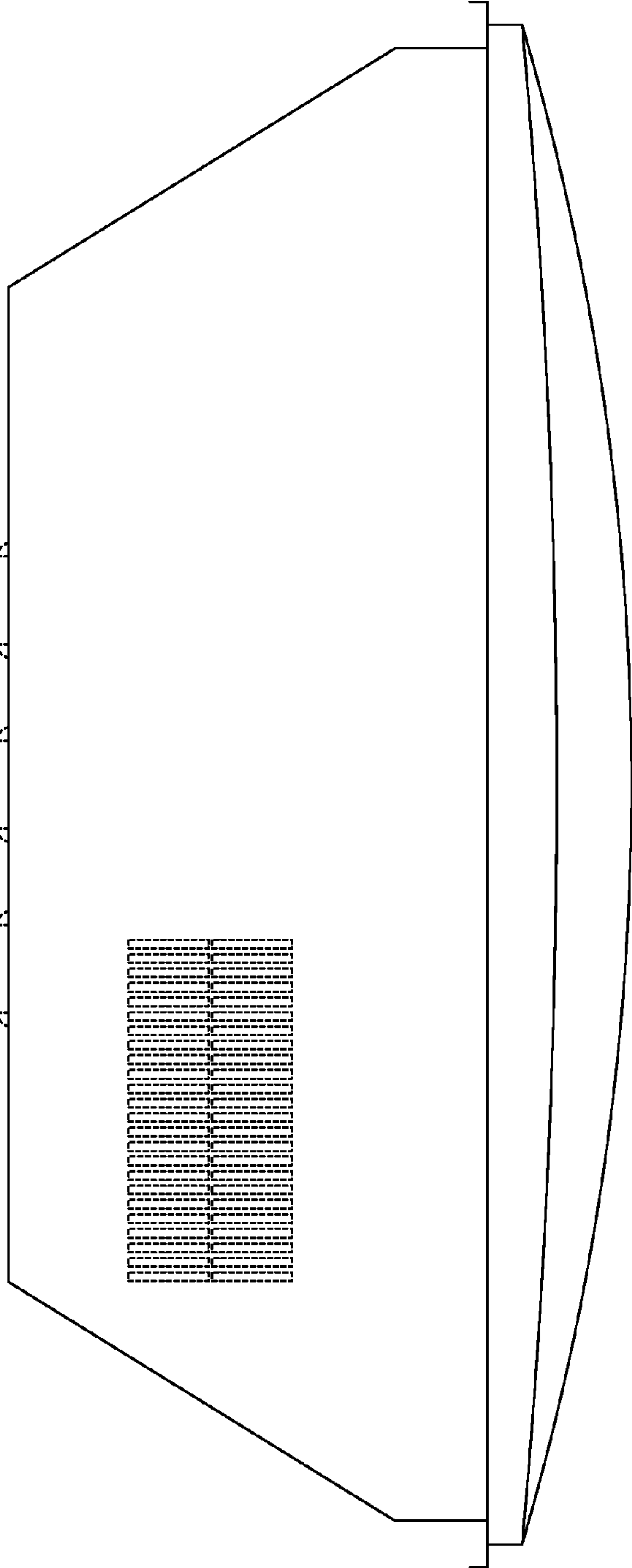

FIG. 23

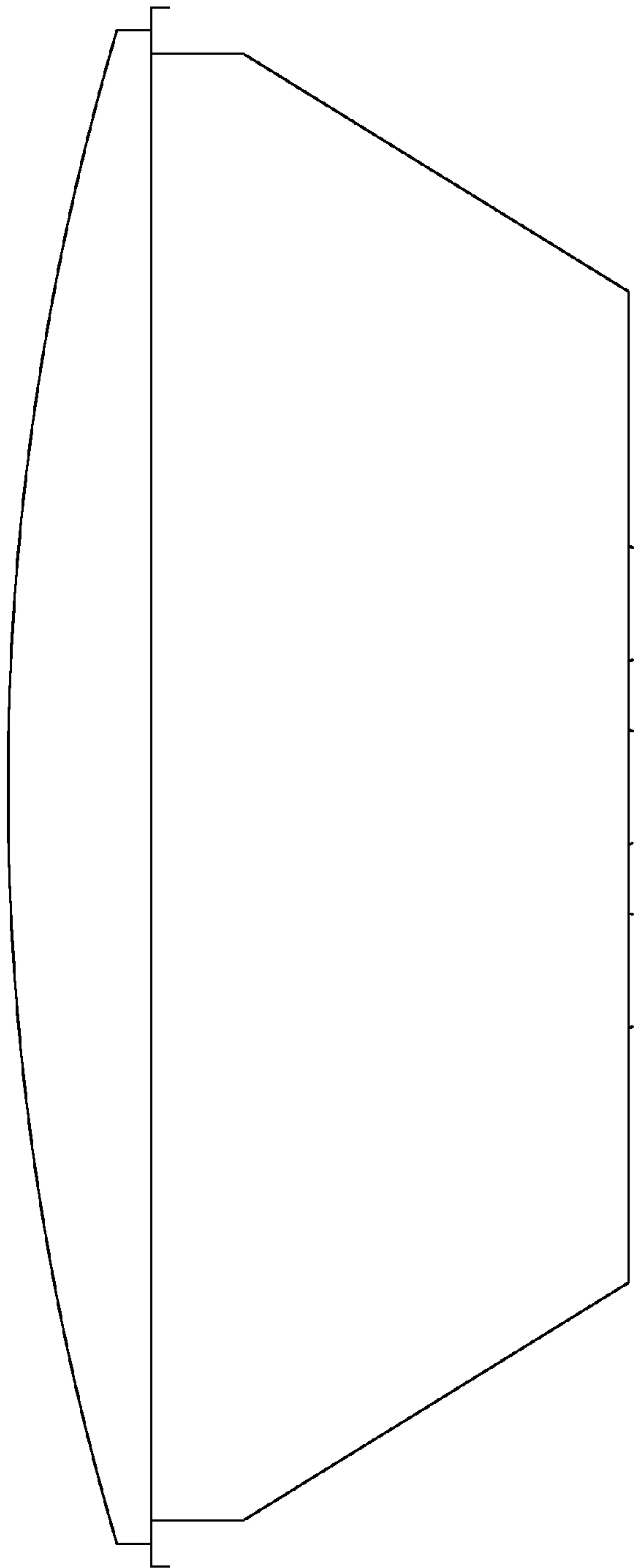

FIG.24

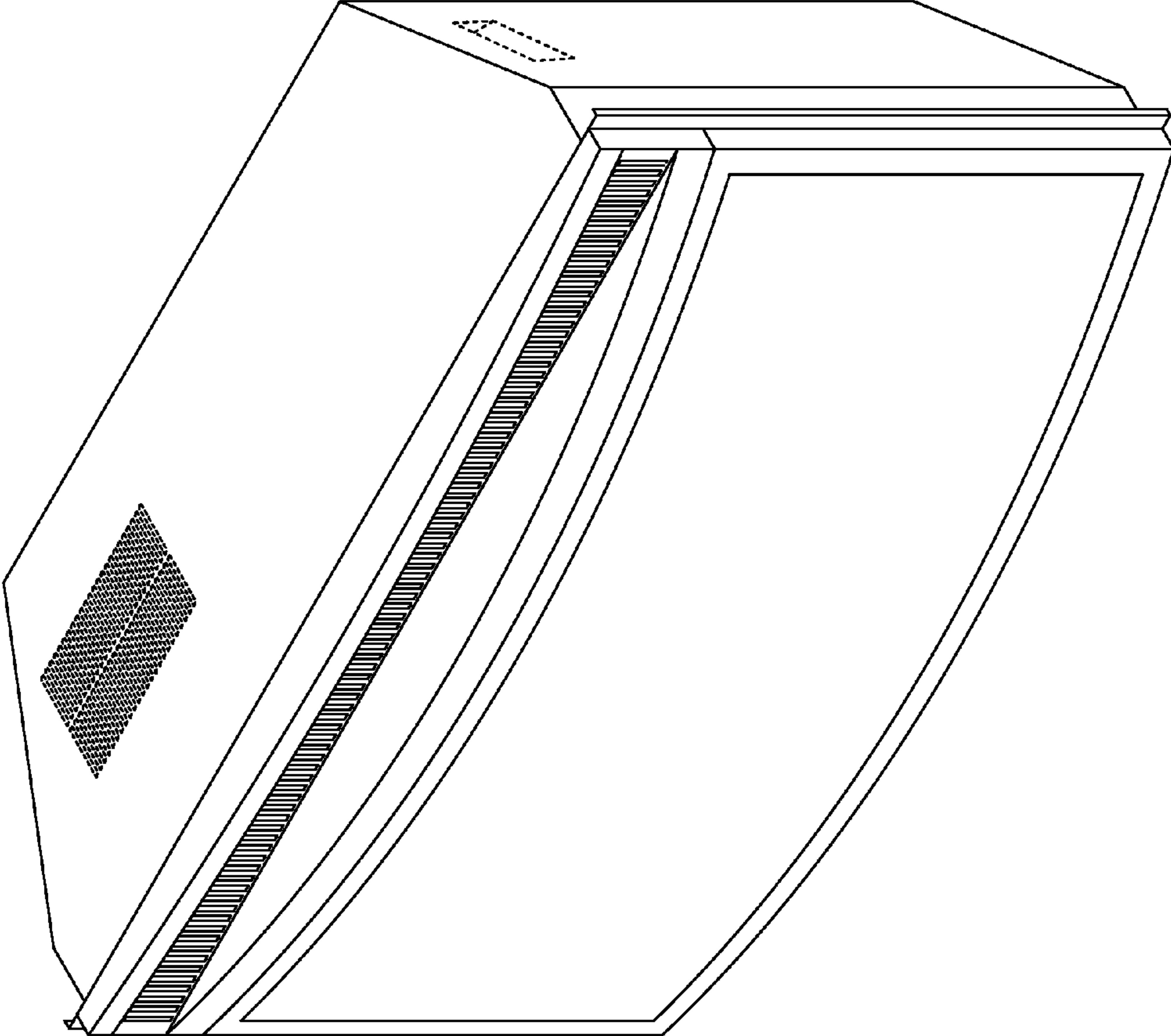

FIG.25

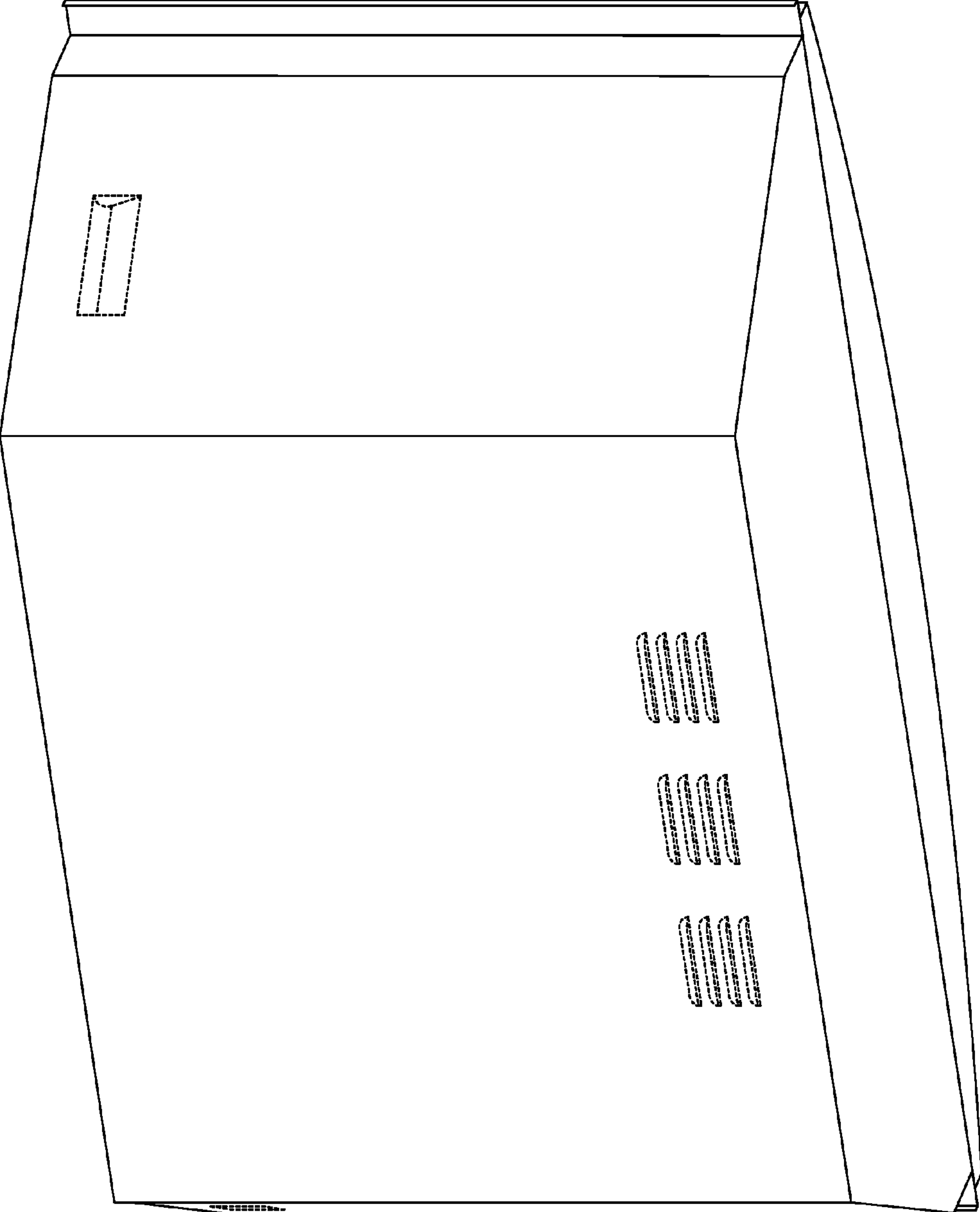

FIG.26

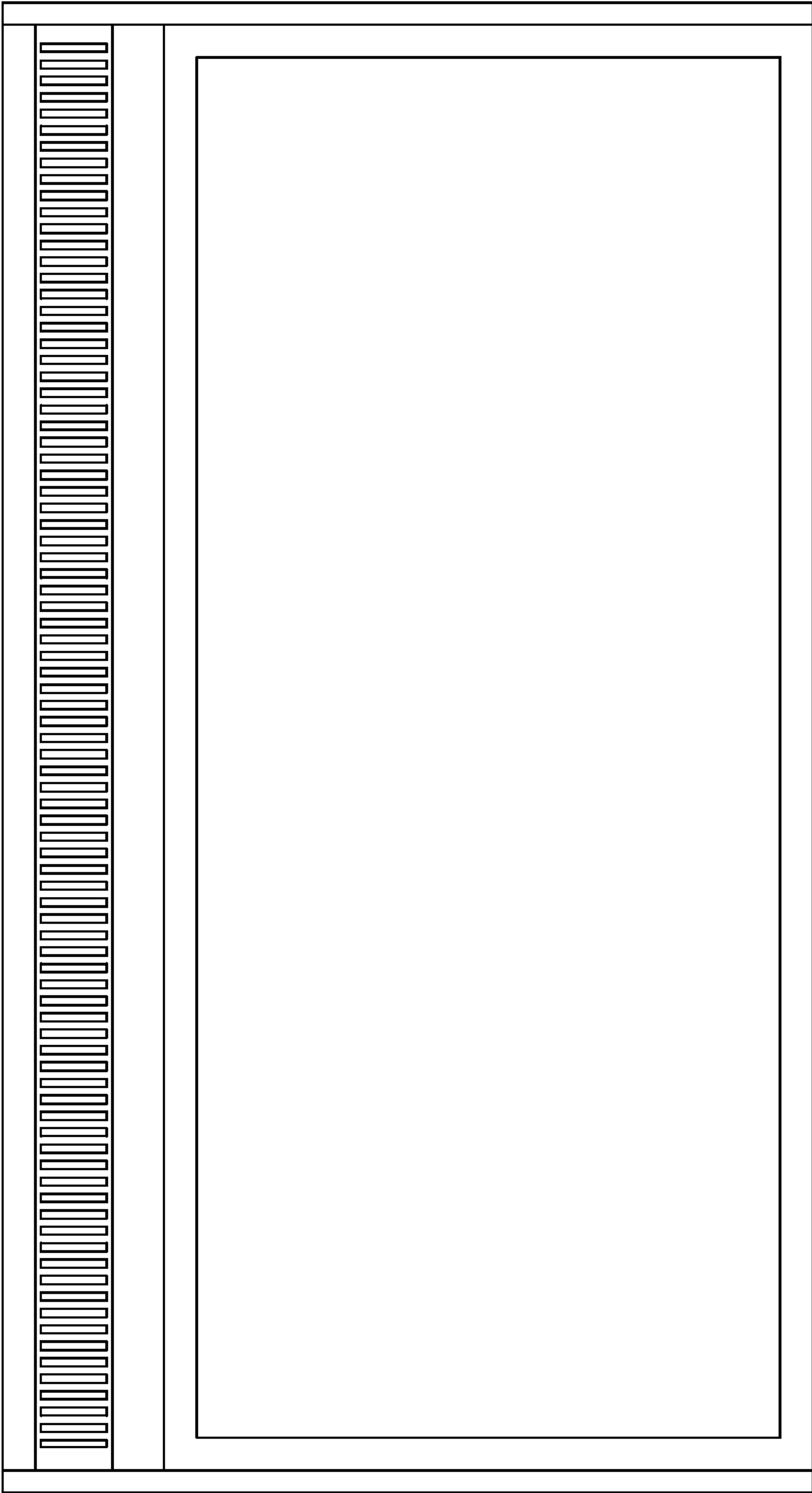

FIG.27



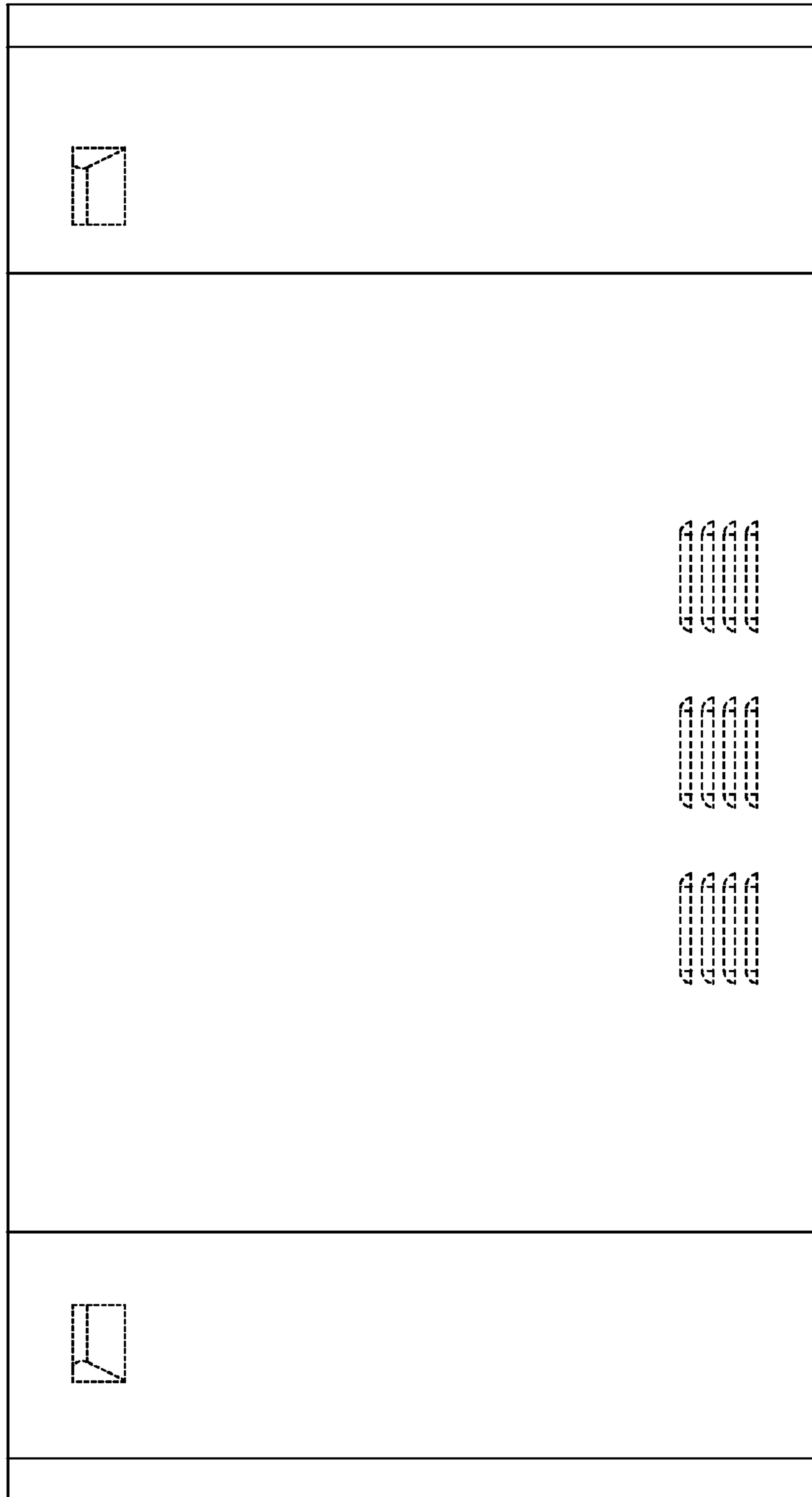

FIG.28

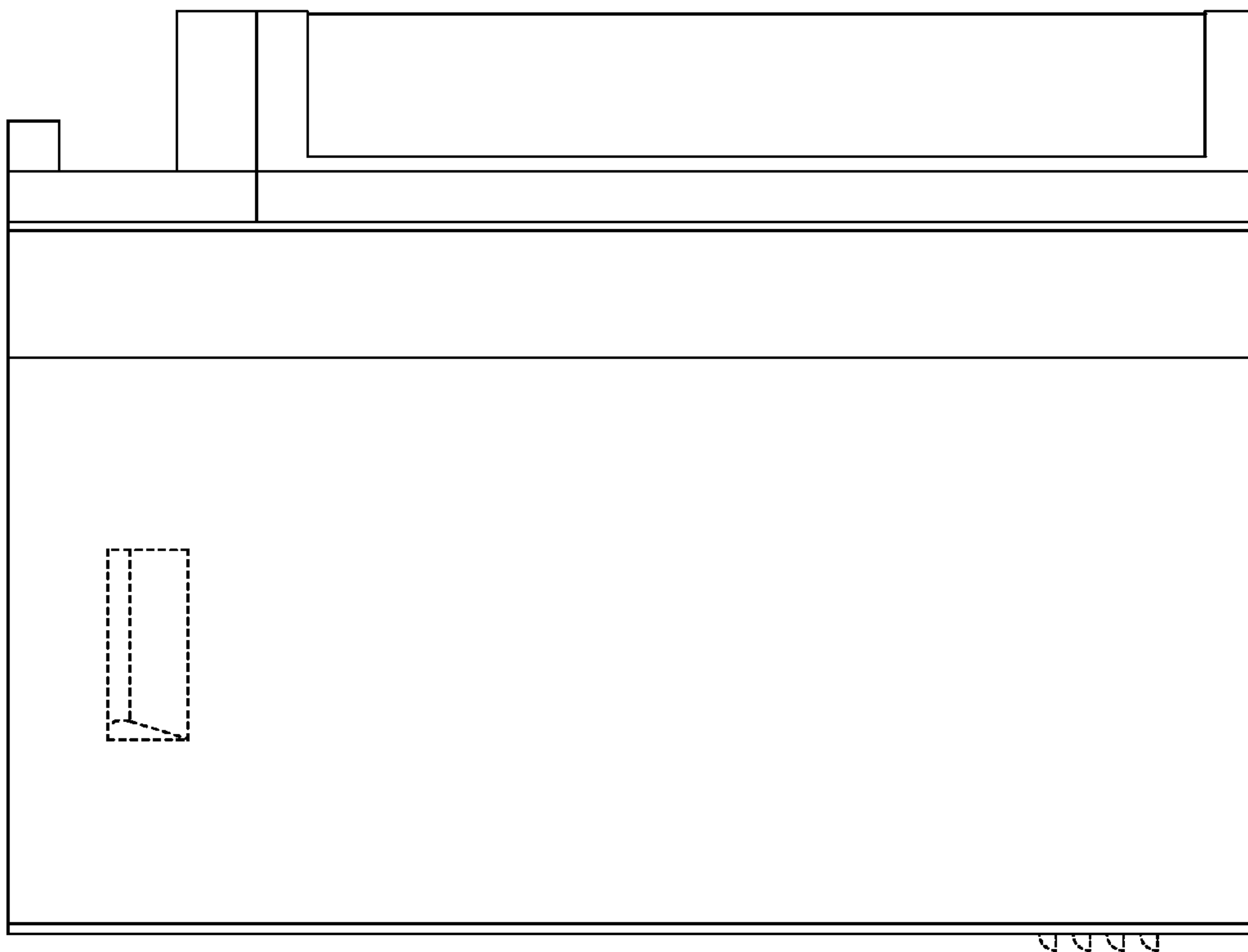

FIG.29

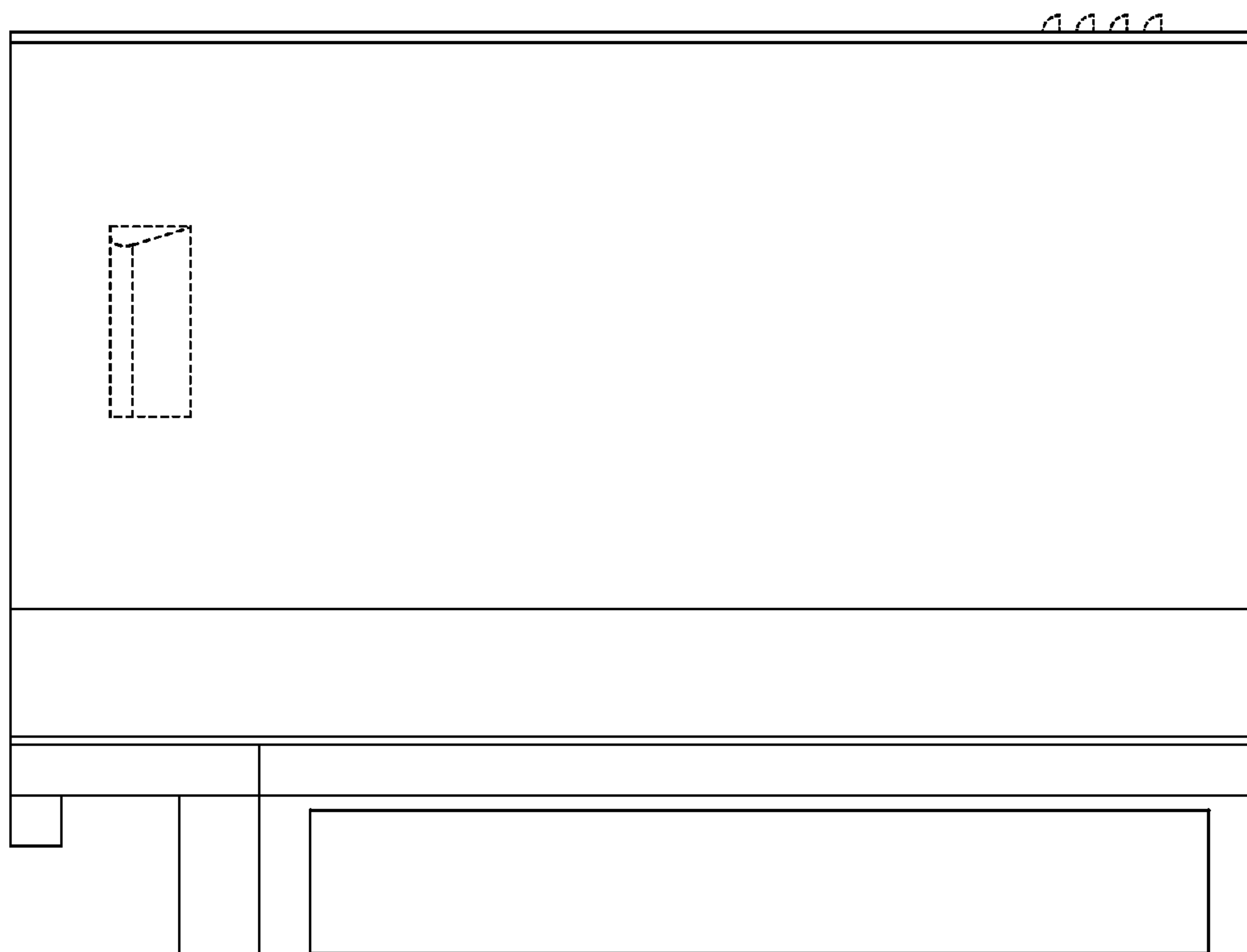

FIG. 30

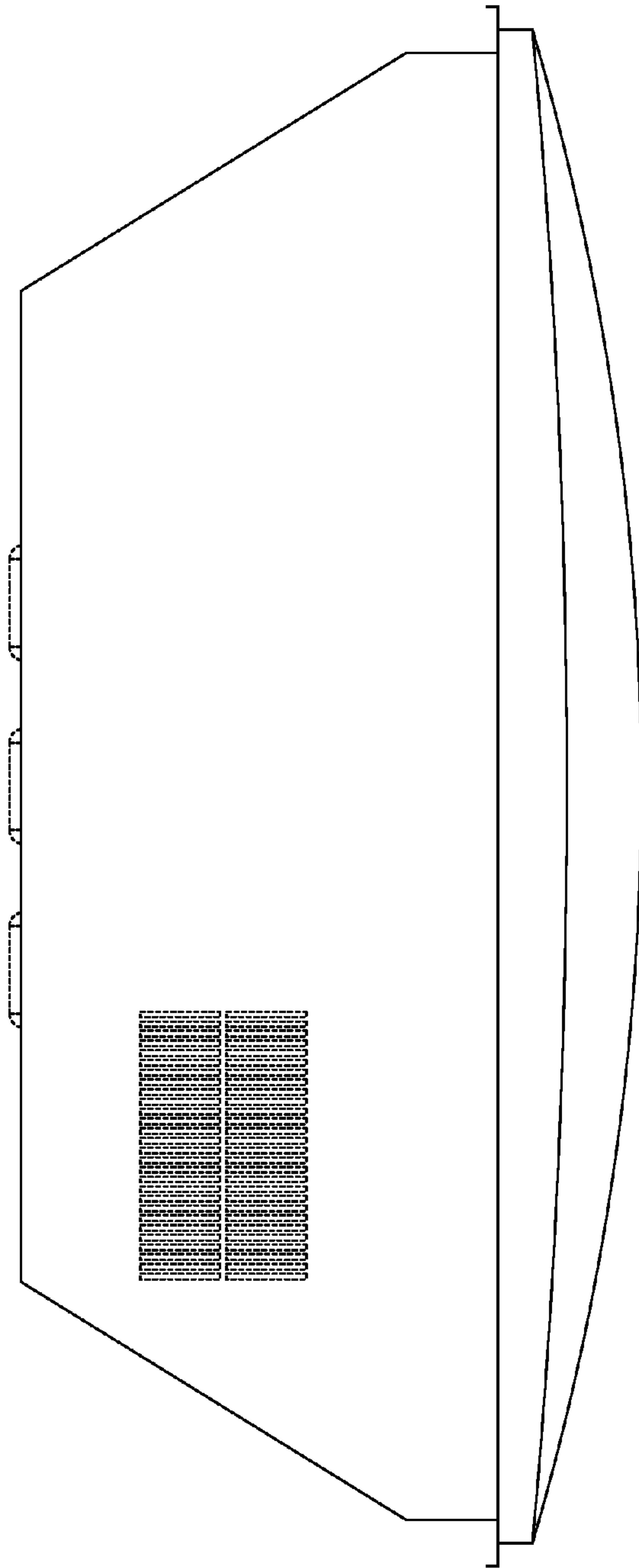

FIG.31

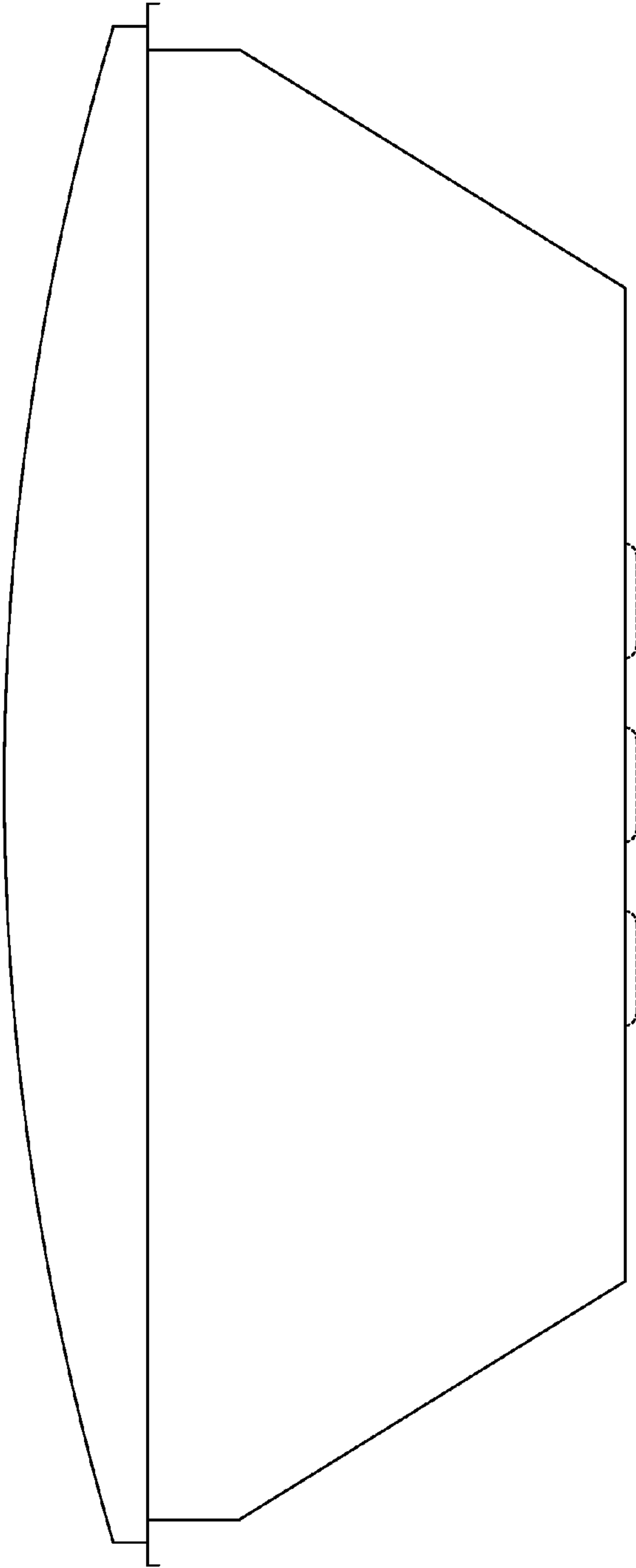

FIG.32

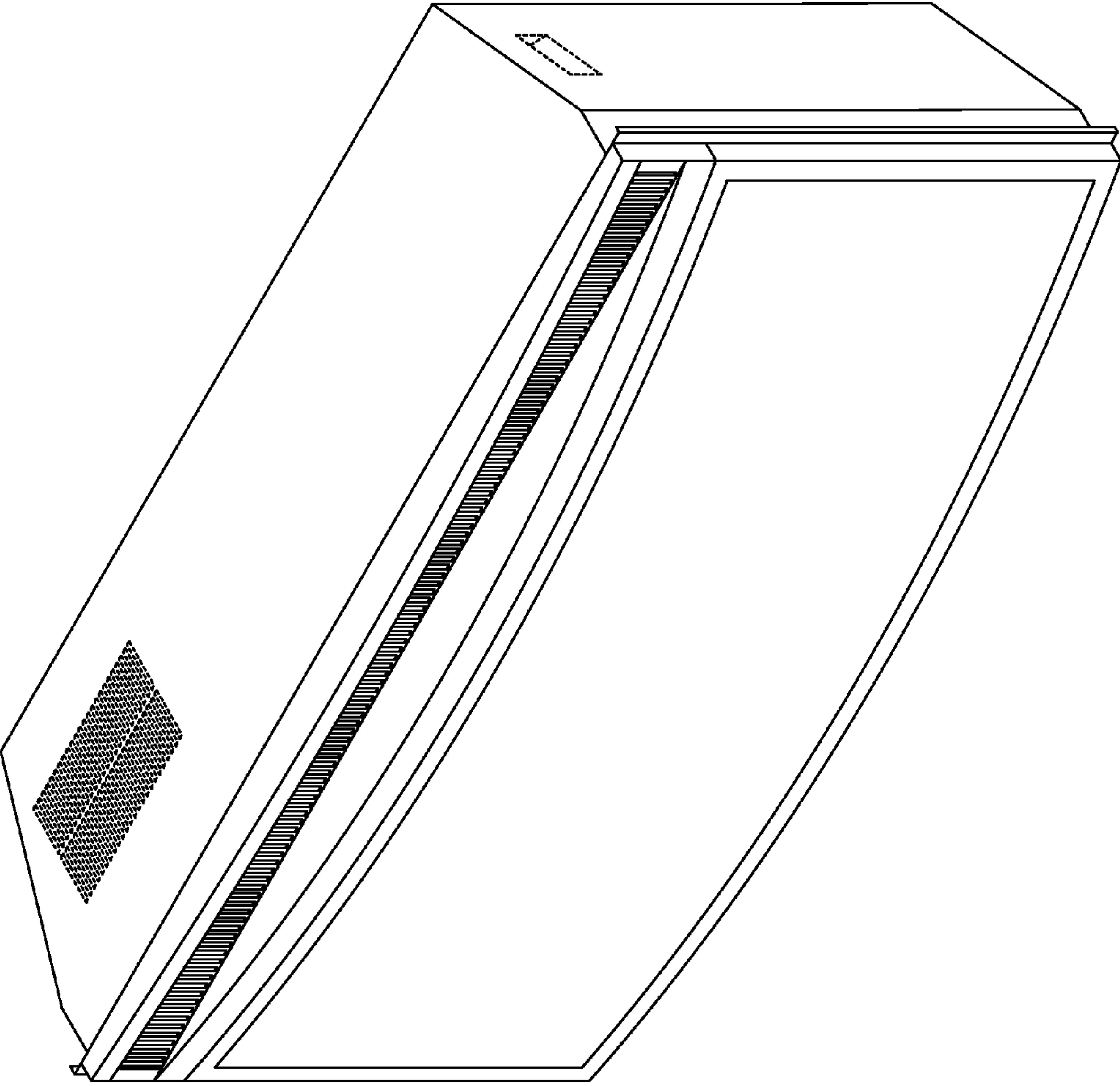

FIG.33

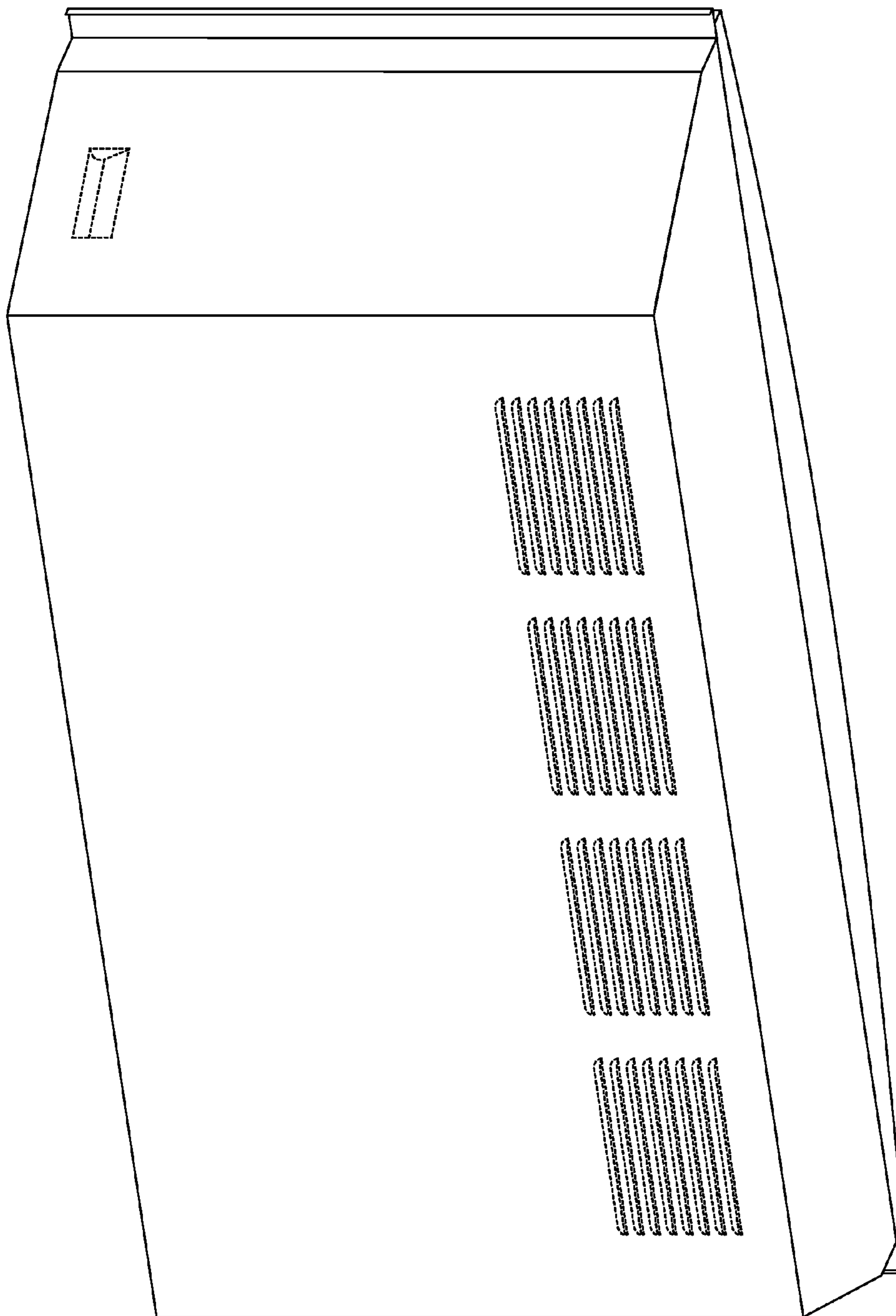

FIG.34



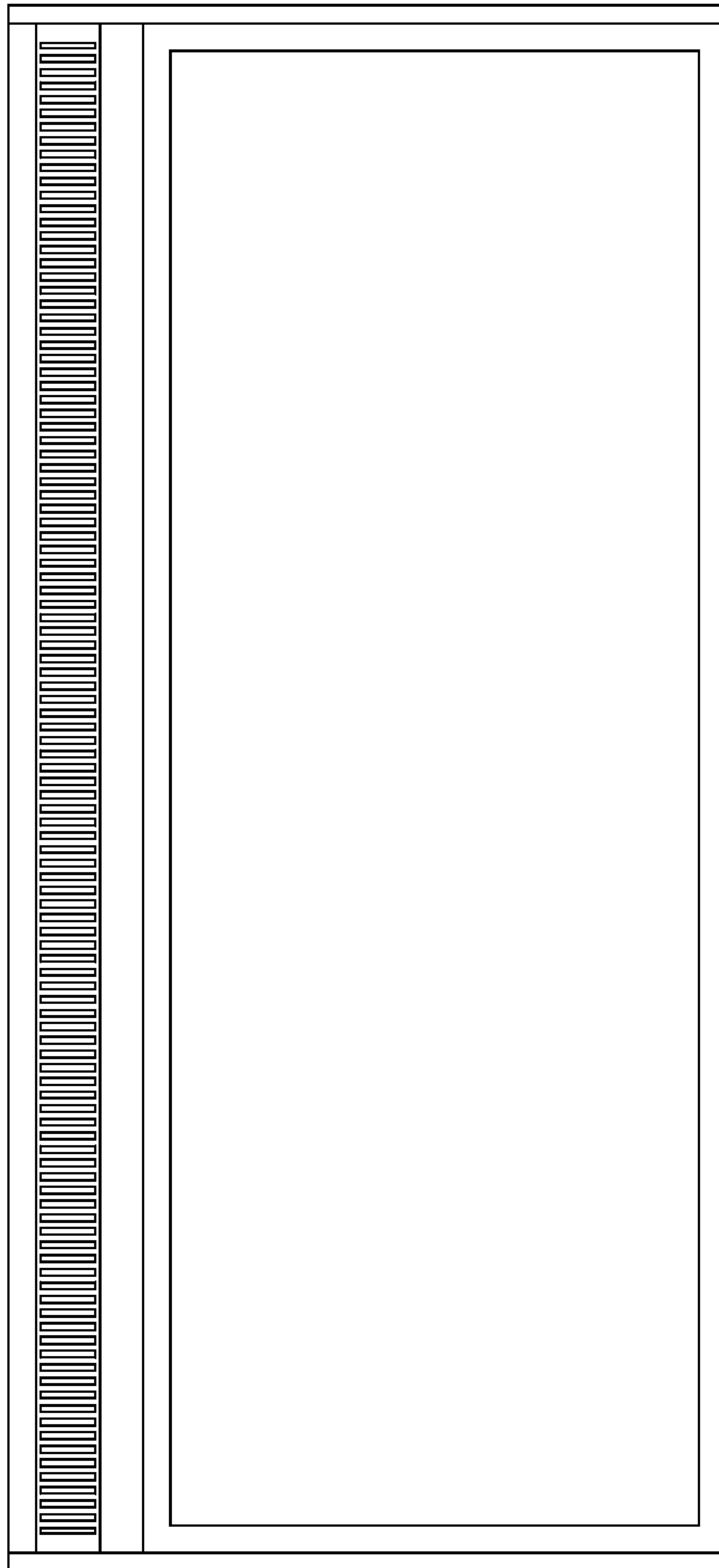

FIG.35

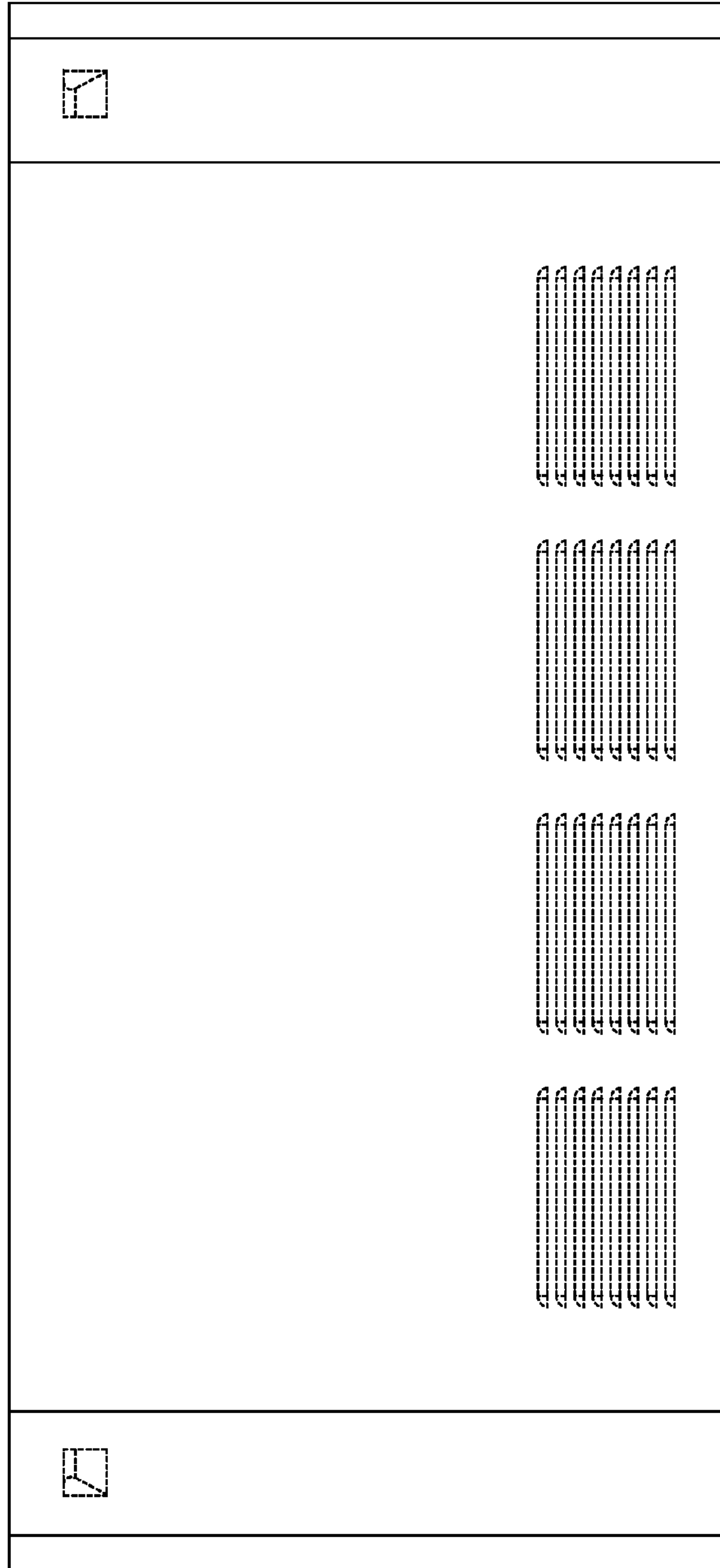

FIG.36

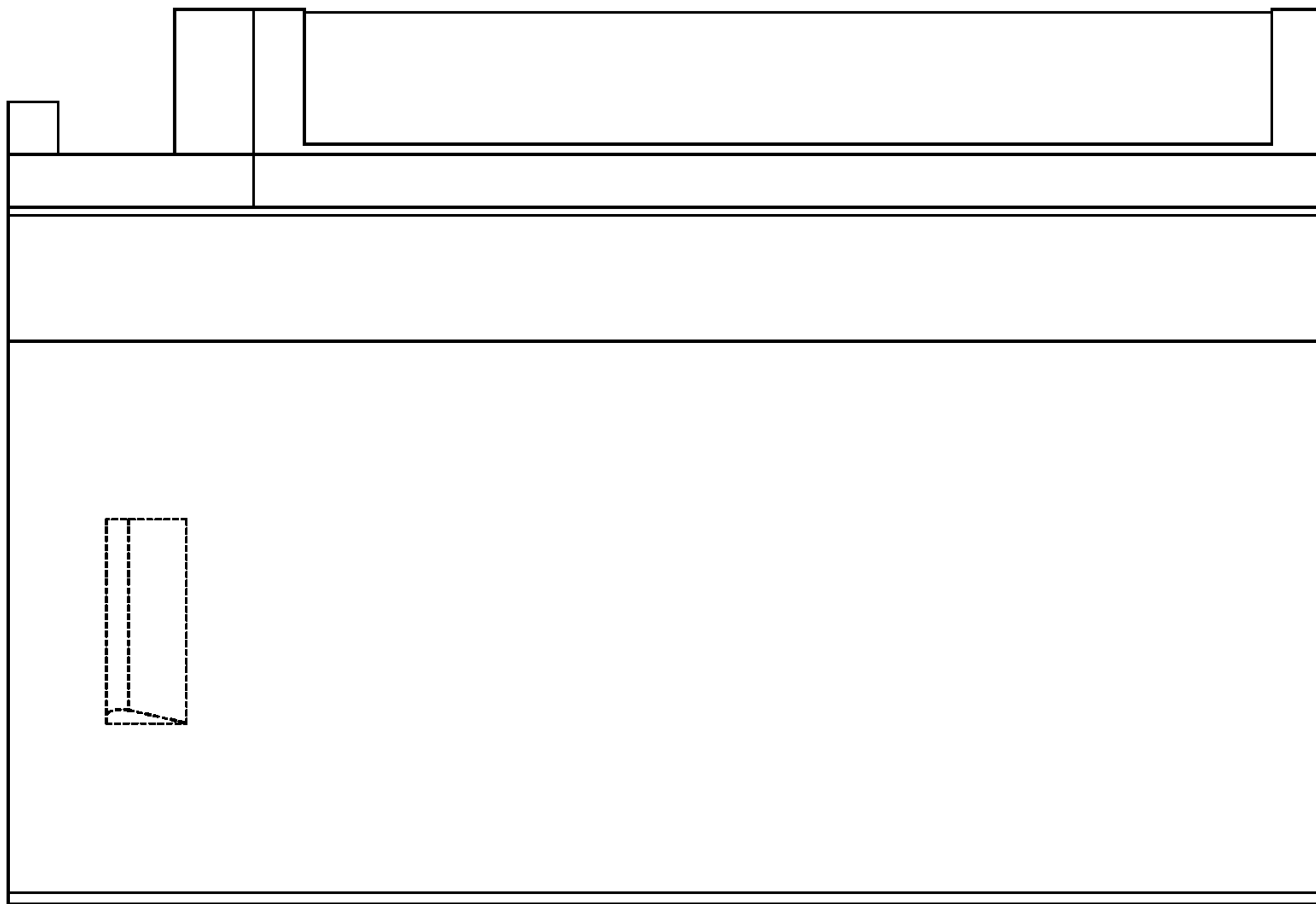

FIG.37

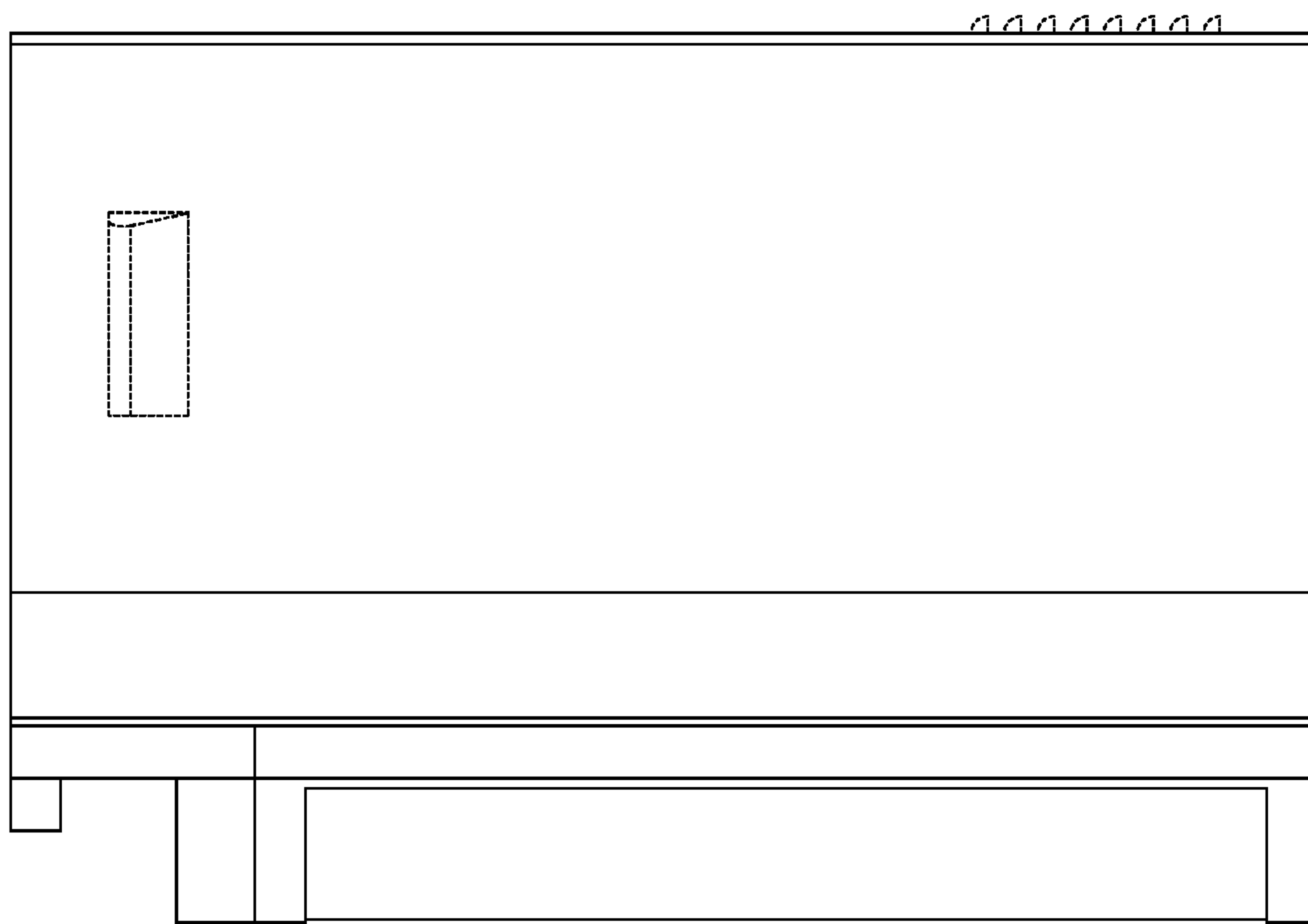

FIG.38

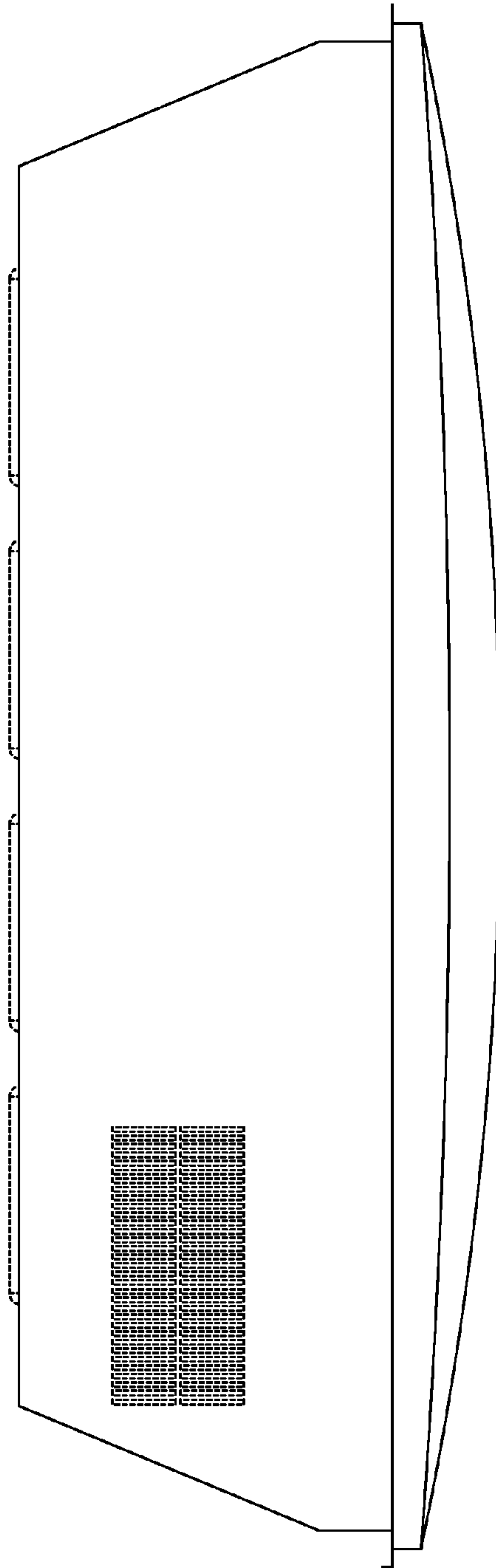

FIG.39

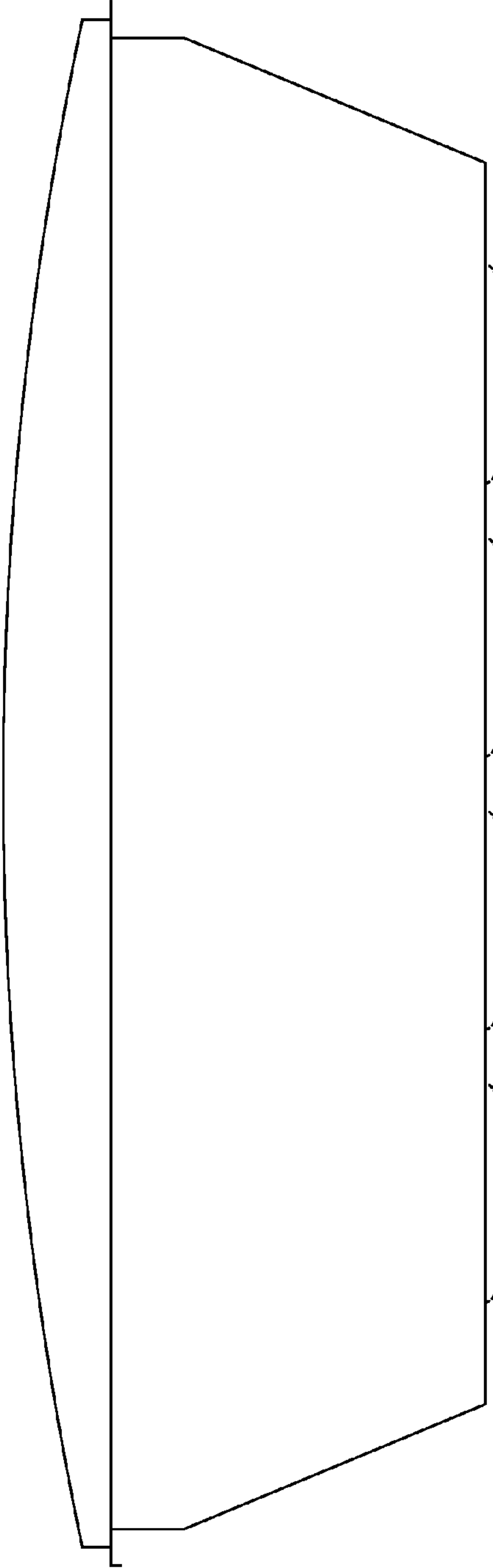

FIG.40

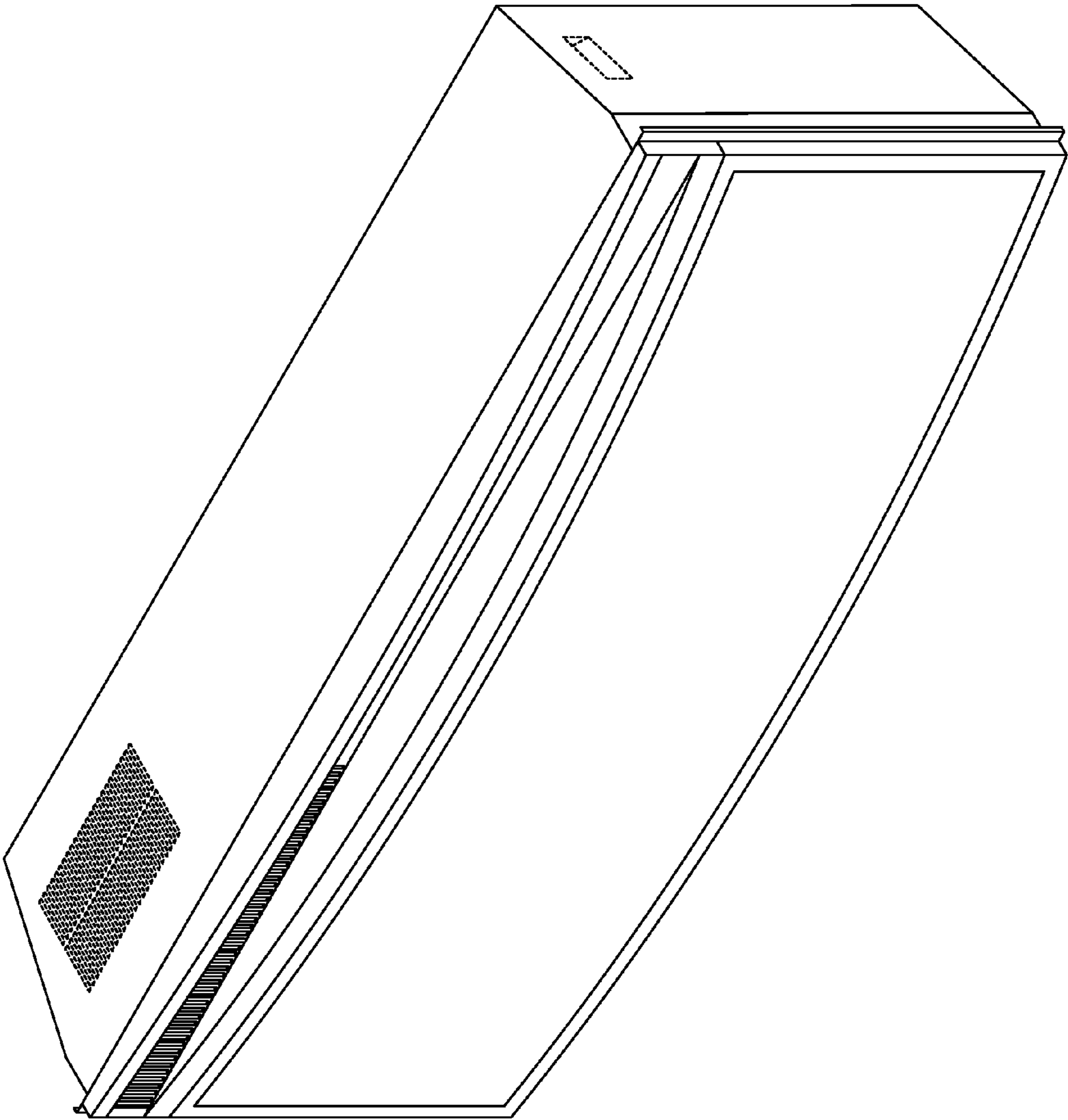

FIG.41

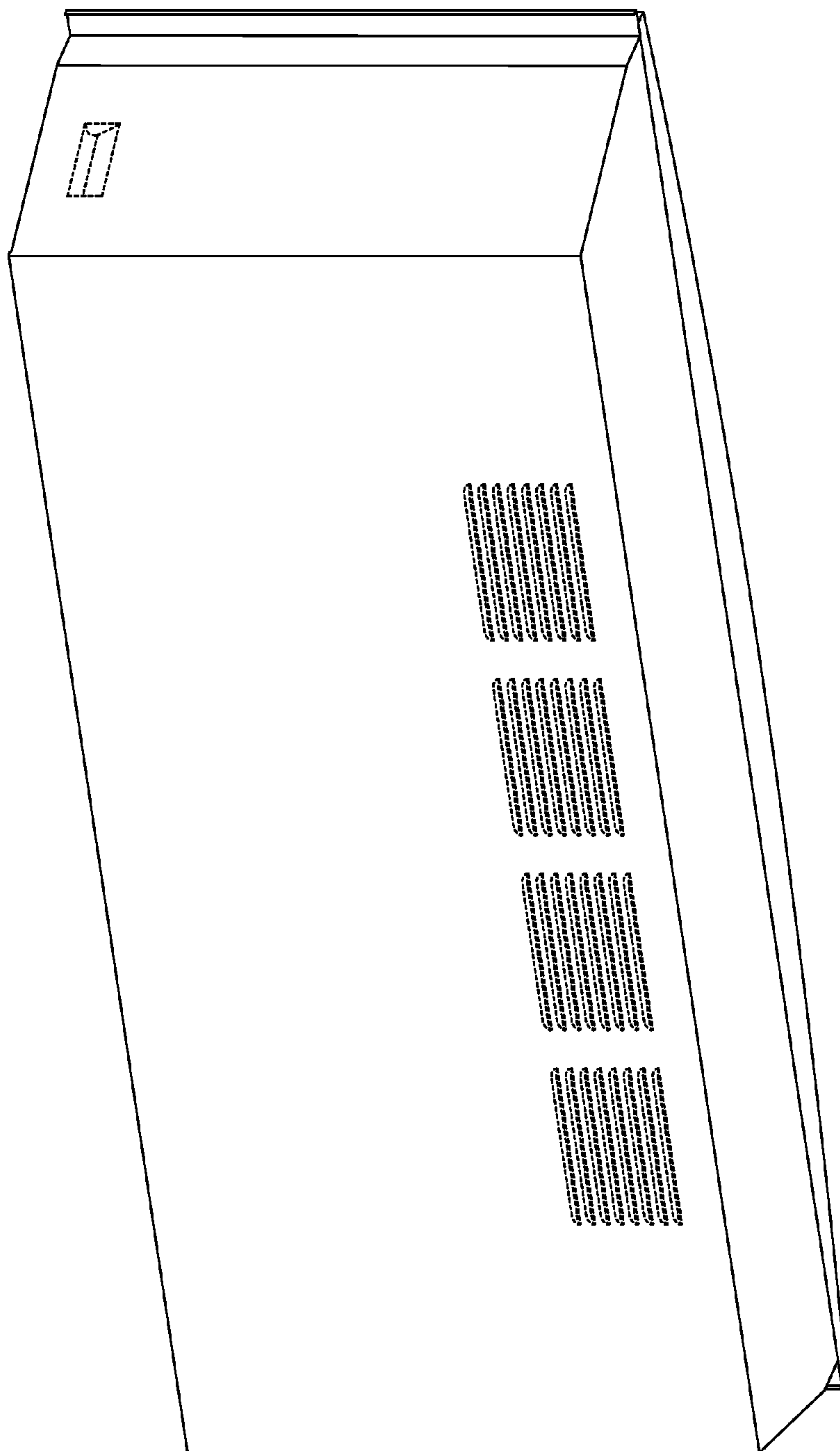

FIG.42



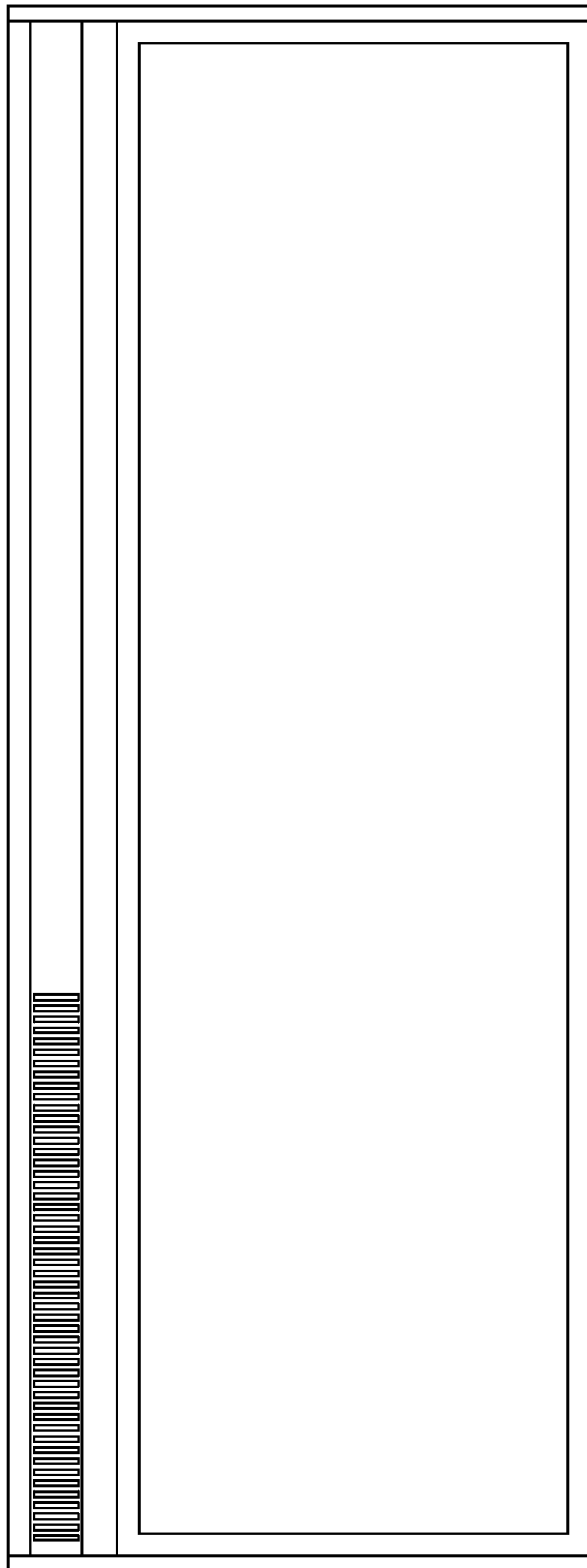

FIG. 43

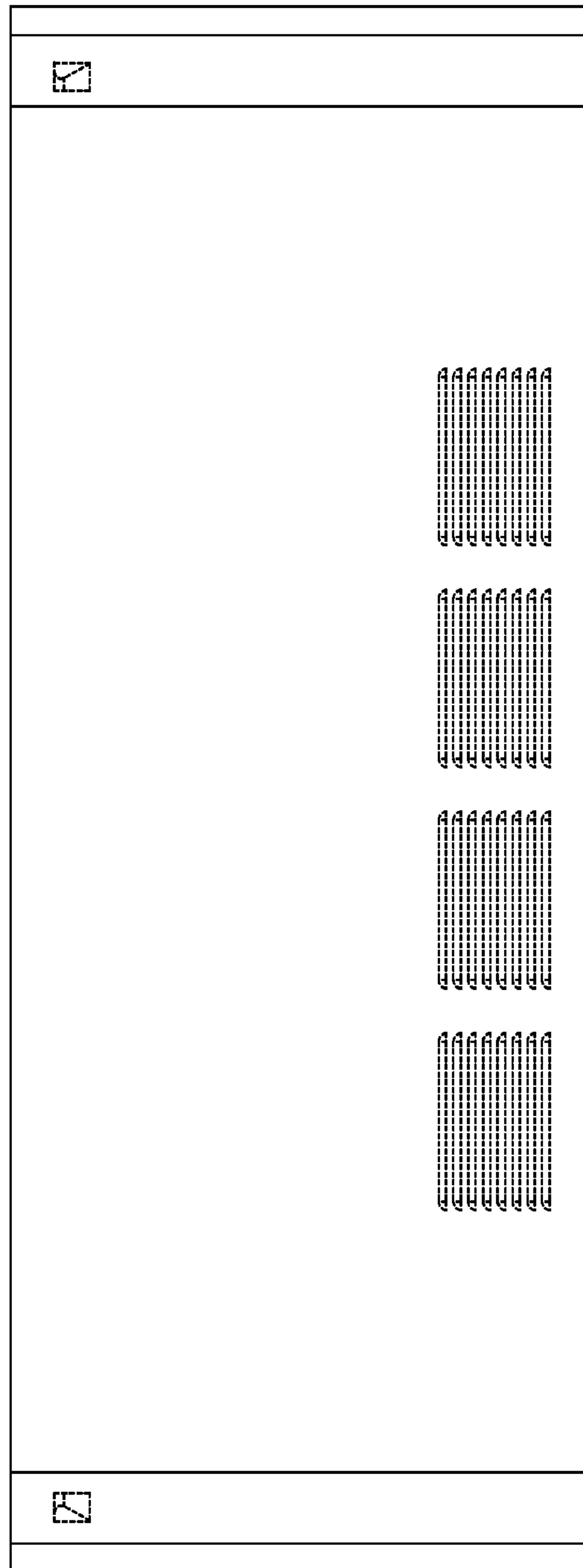

FIG. 44

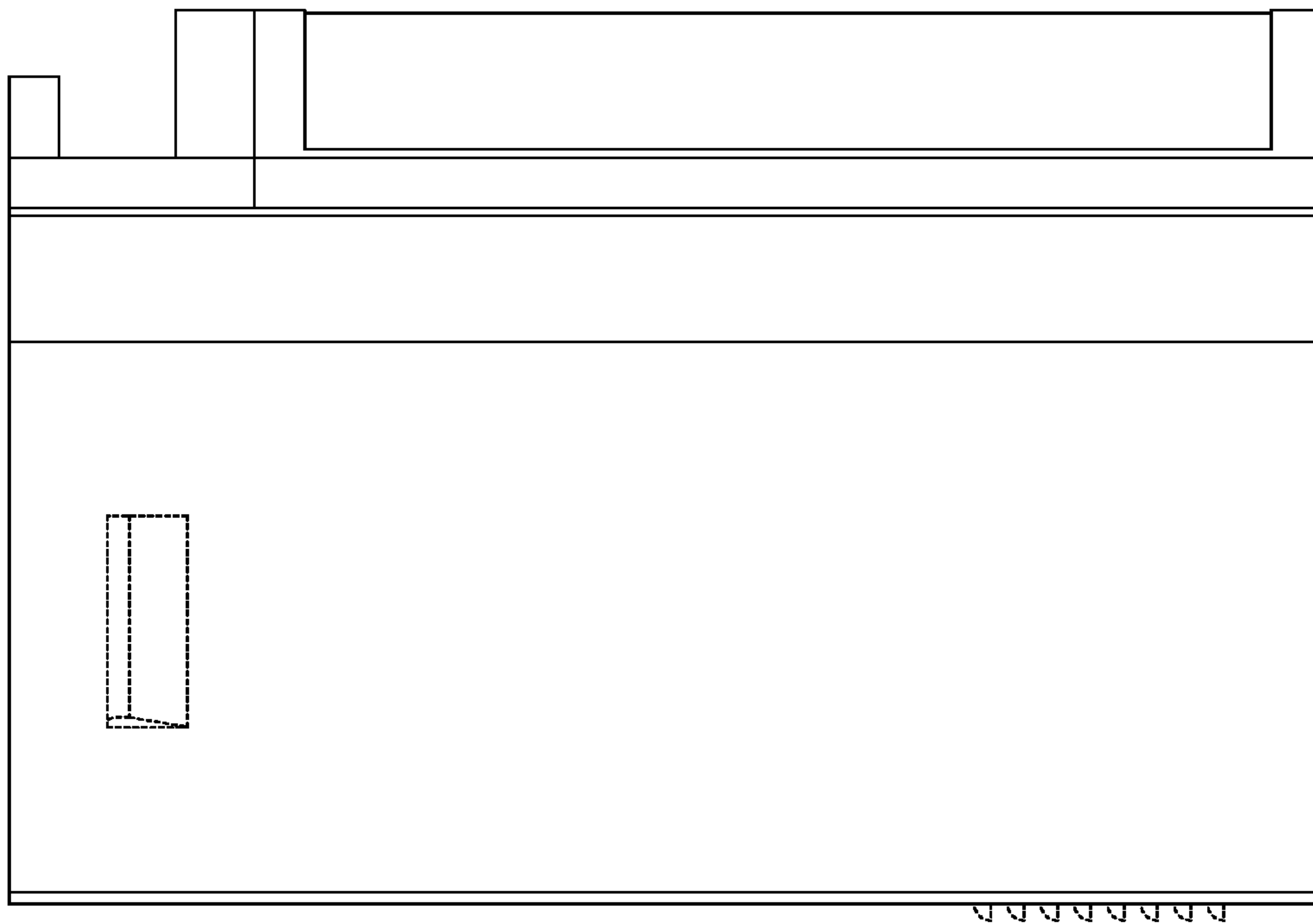

FIG. 45

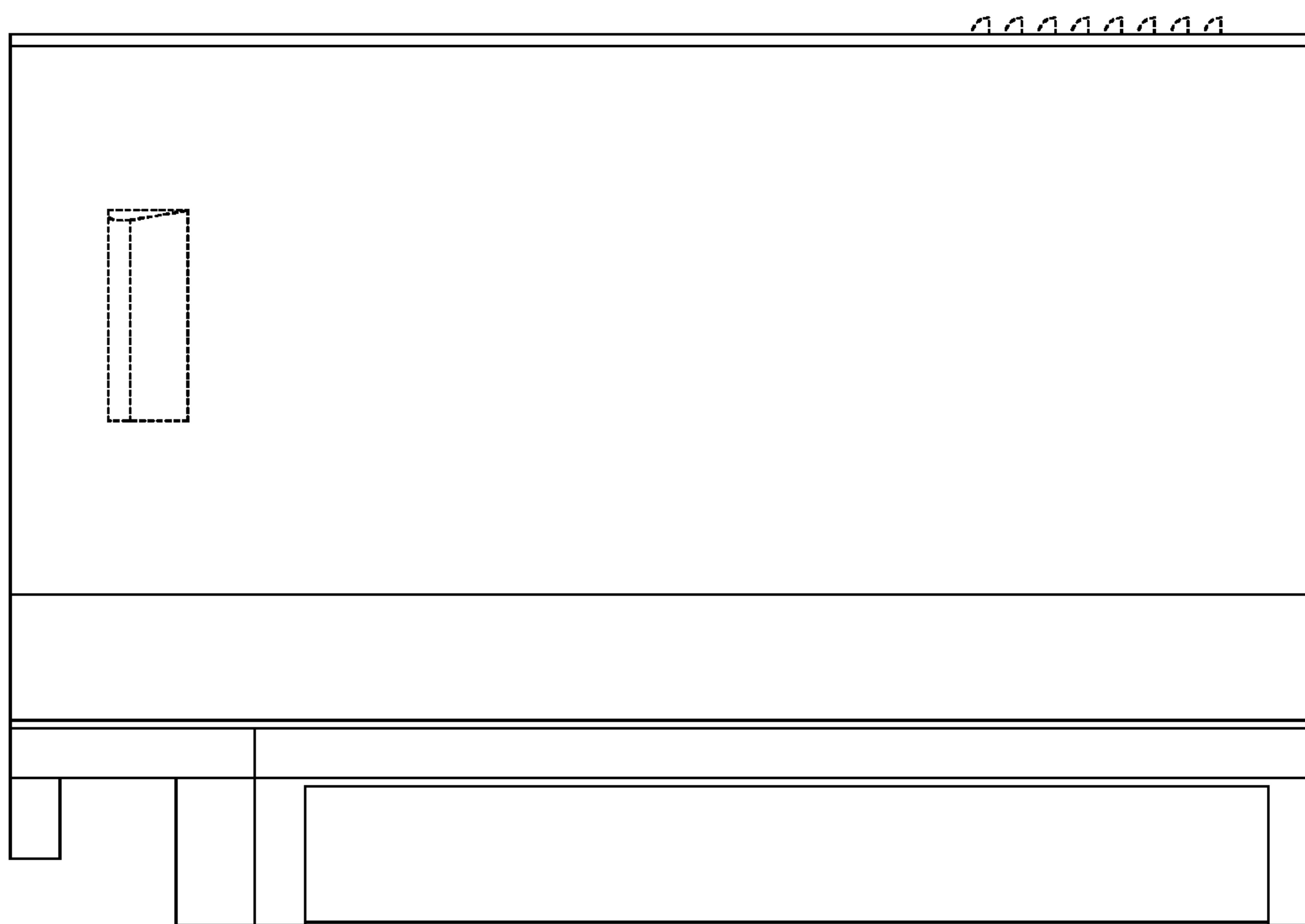

FIG.46

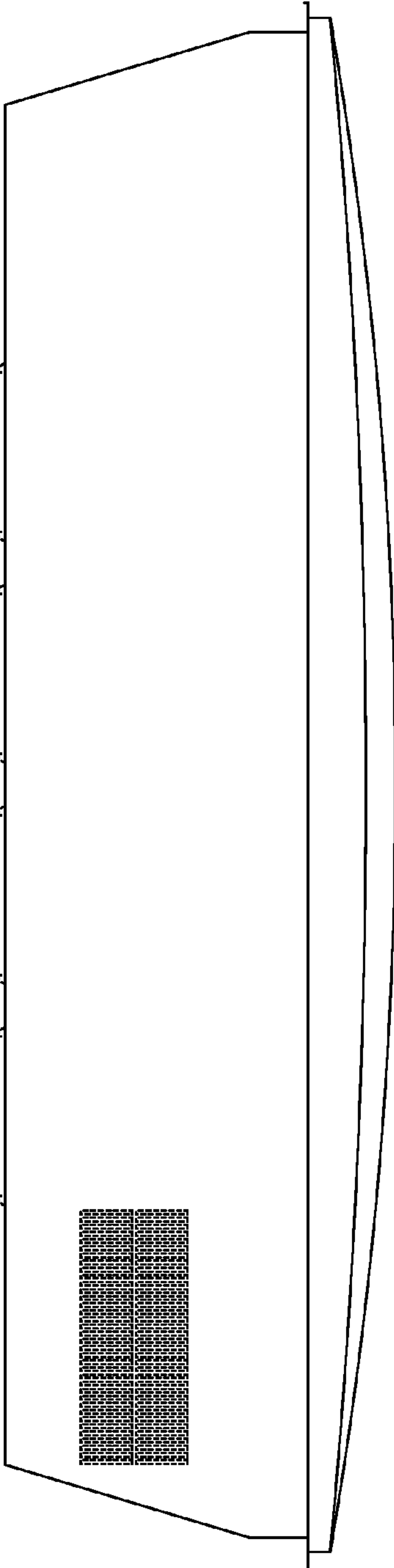

FIG.47

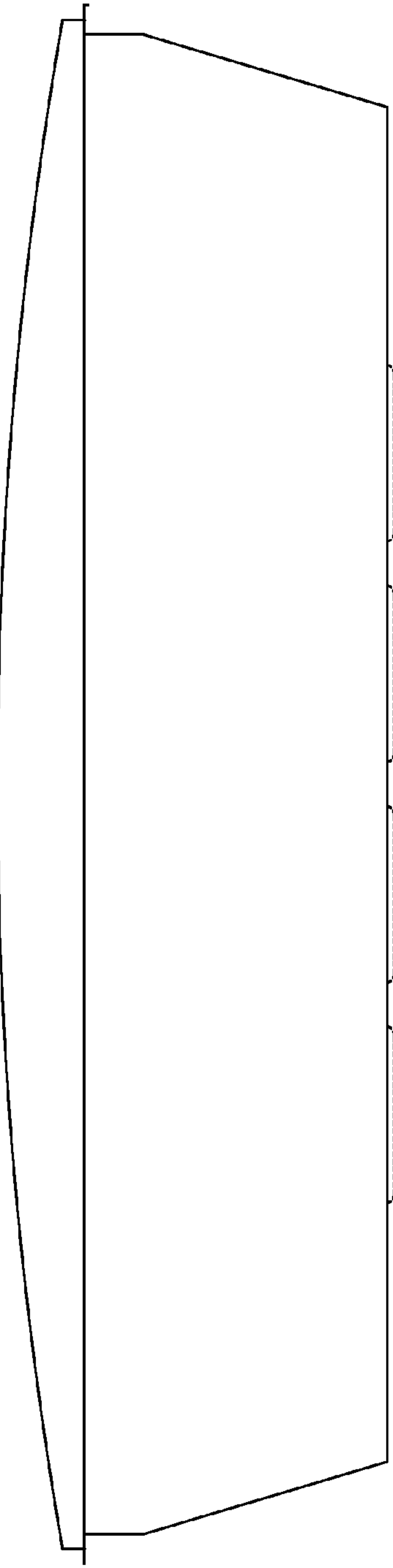

FIG.48

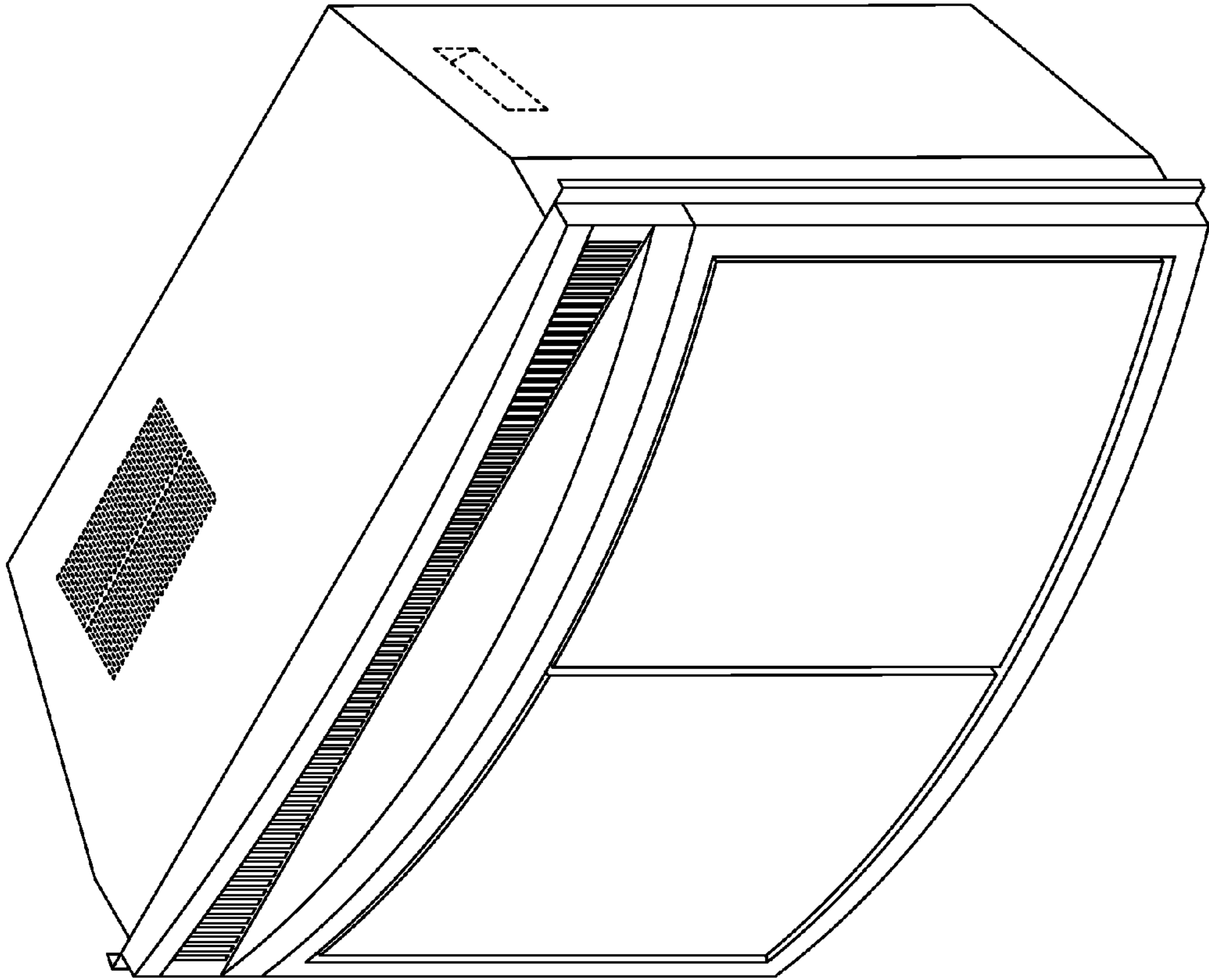

FIG.49

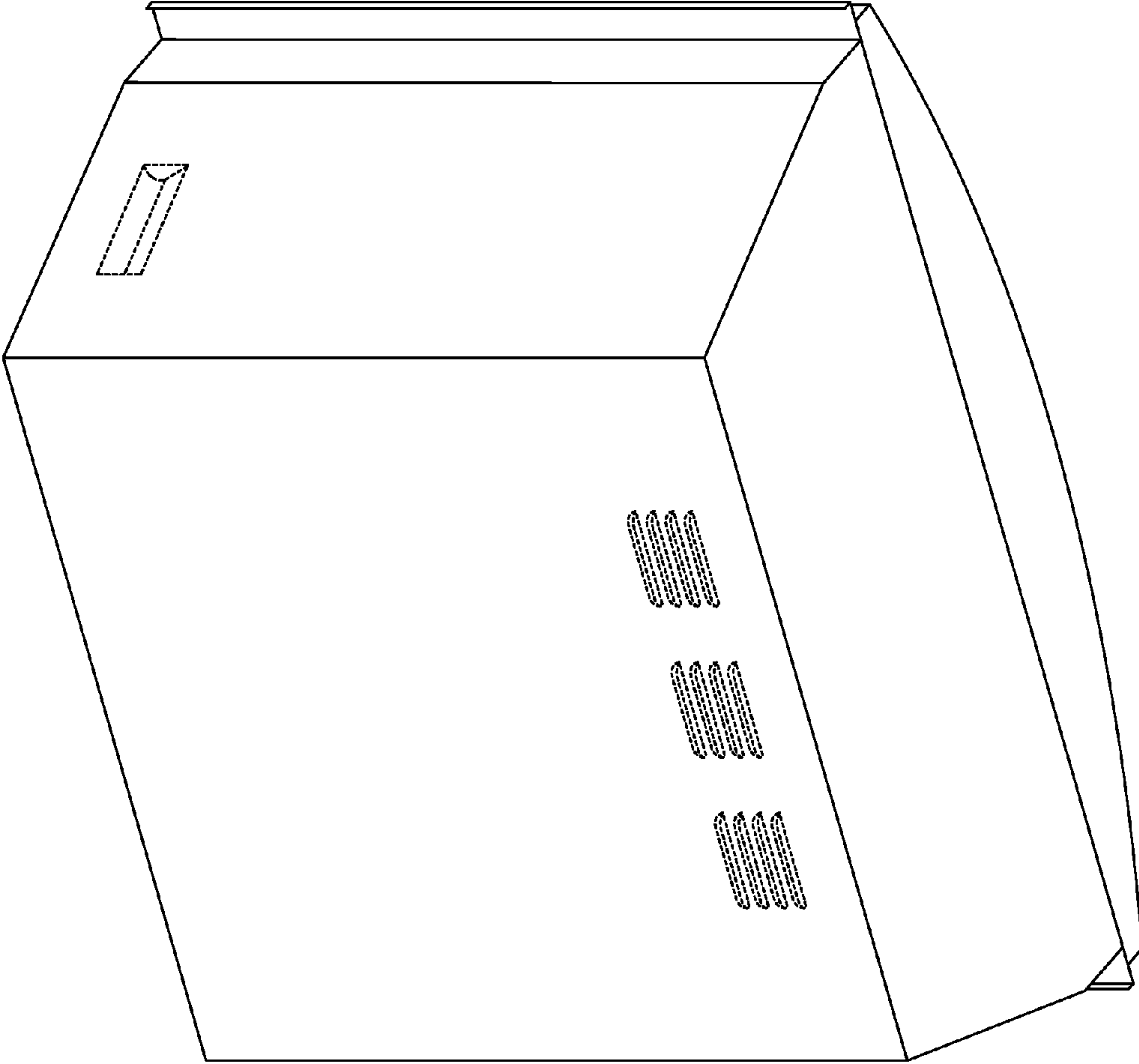

FIG.50



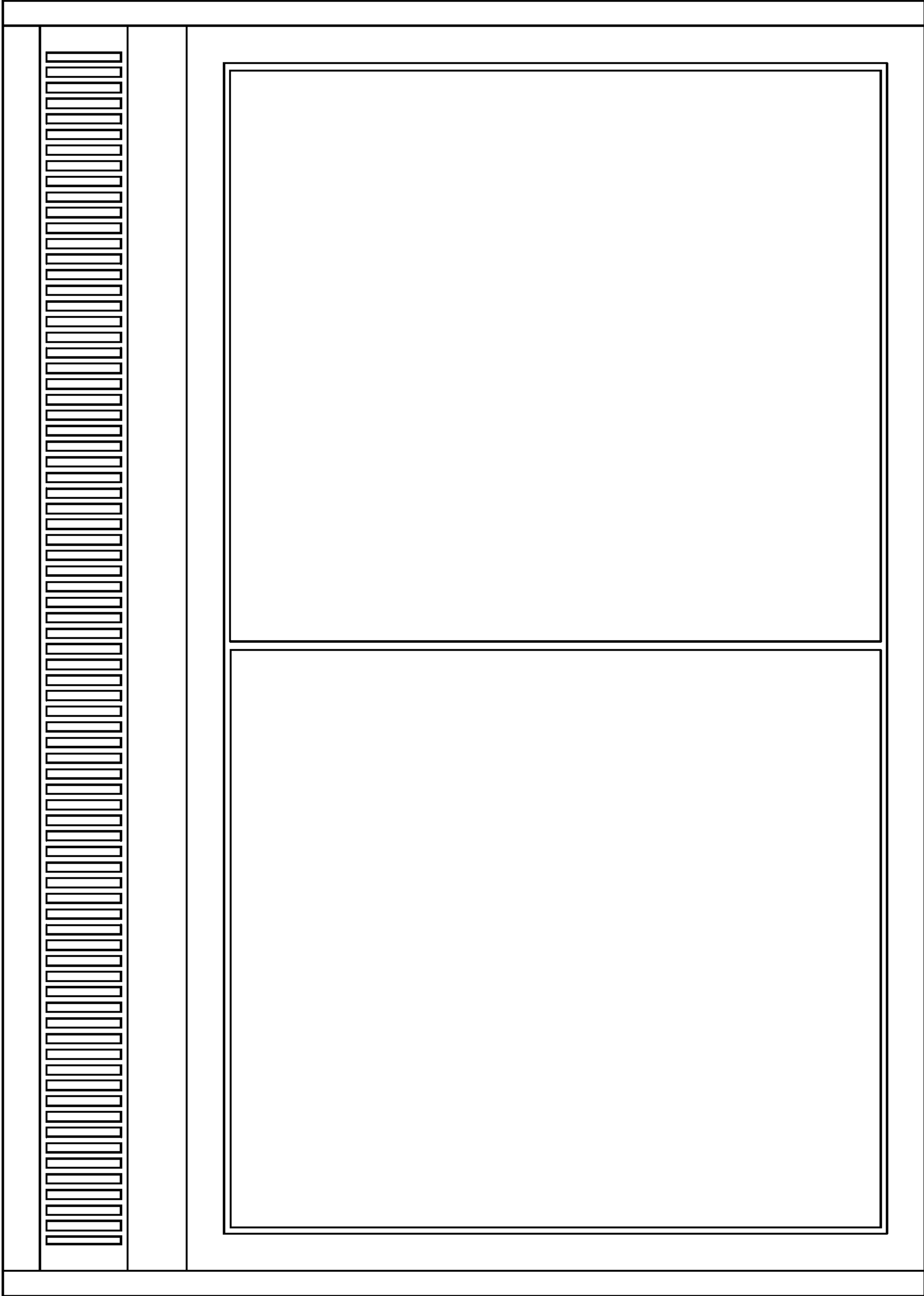

FIG. 51

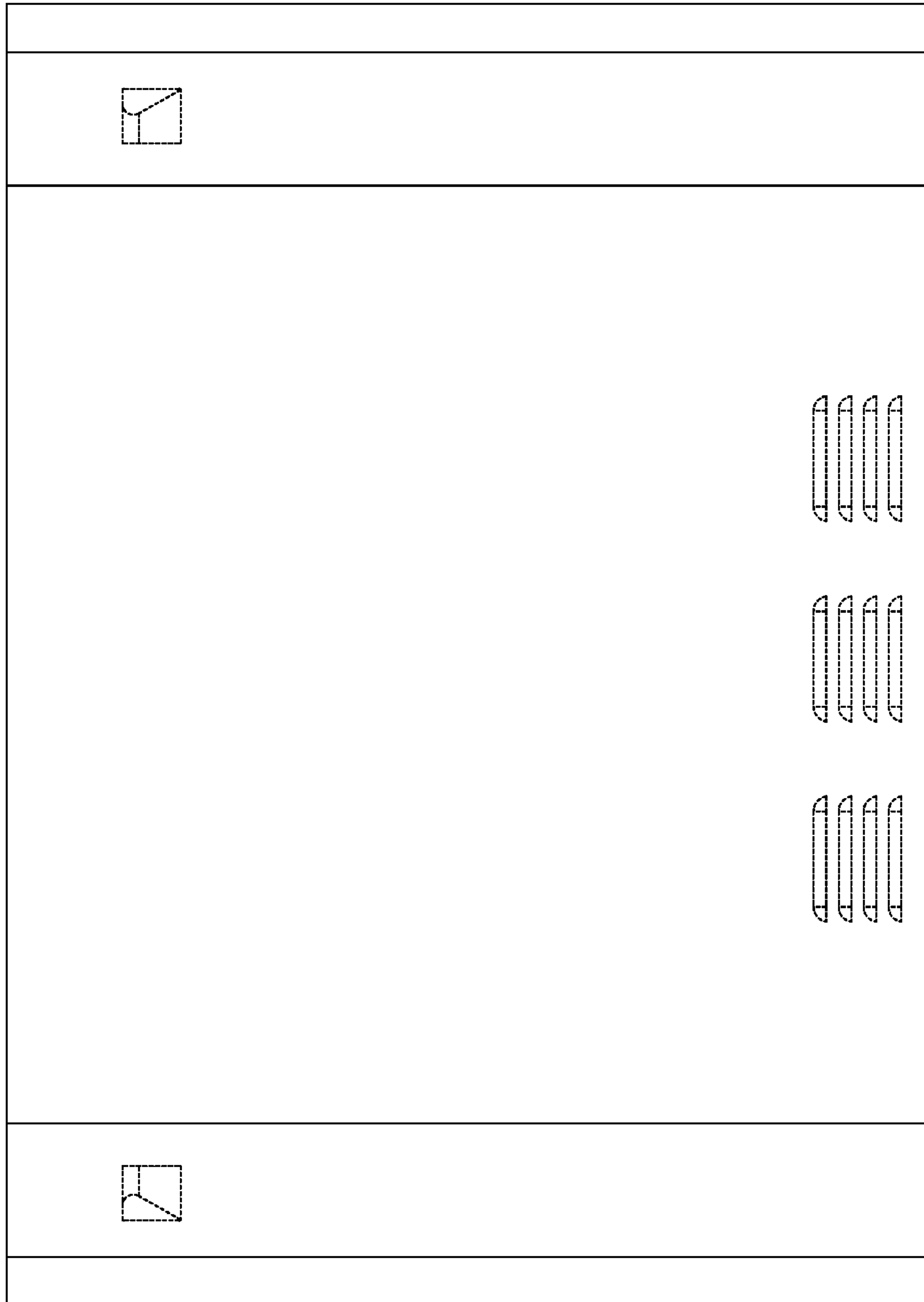

FIG. 52

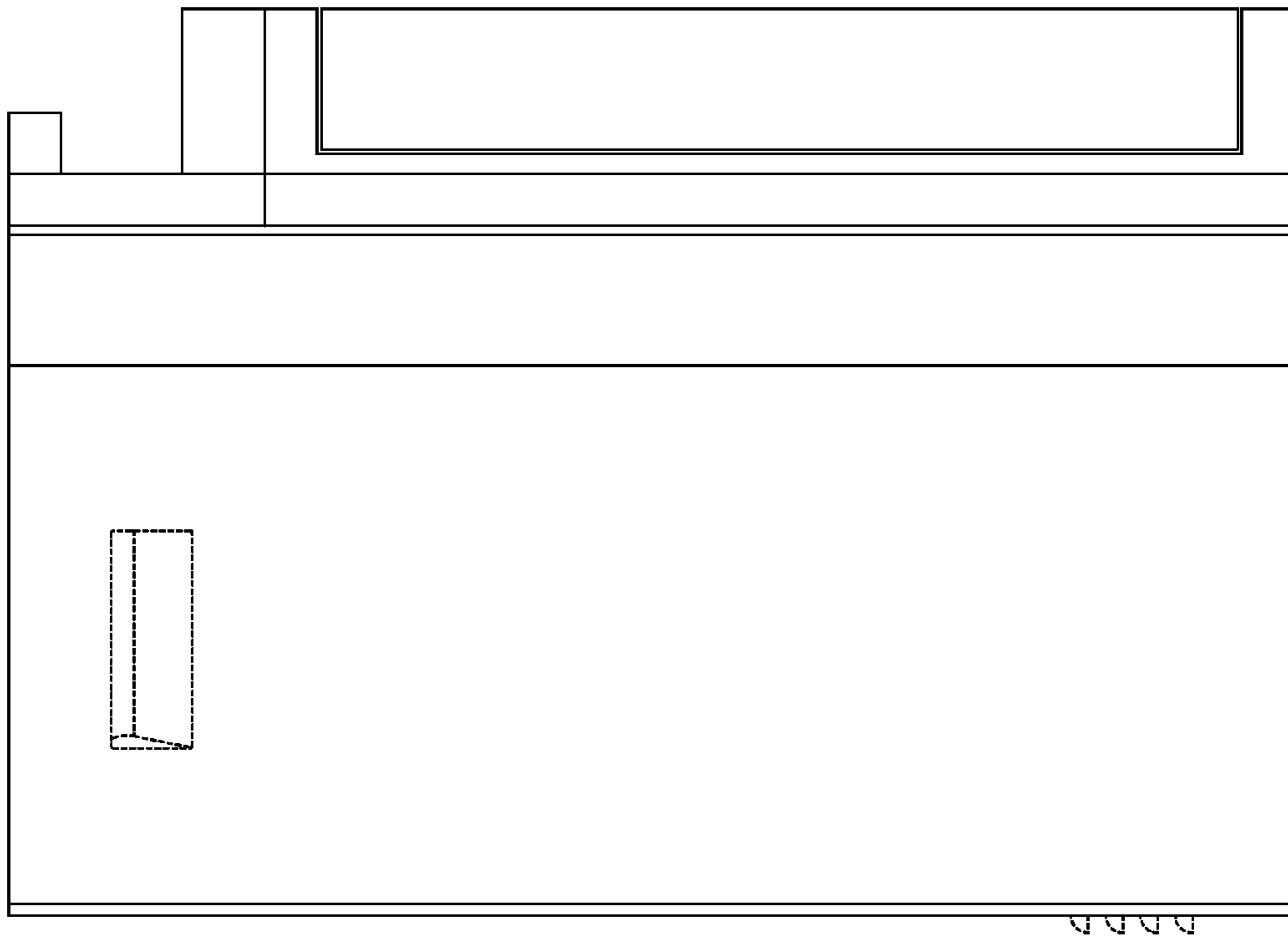

FIG. 53

FIG. 53

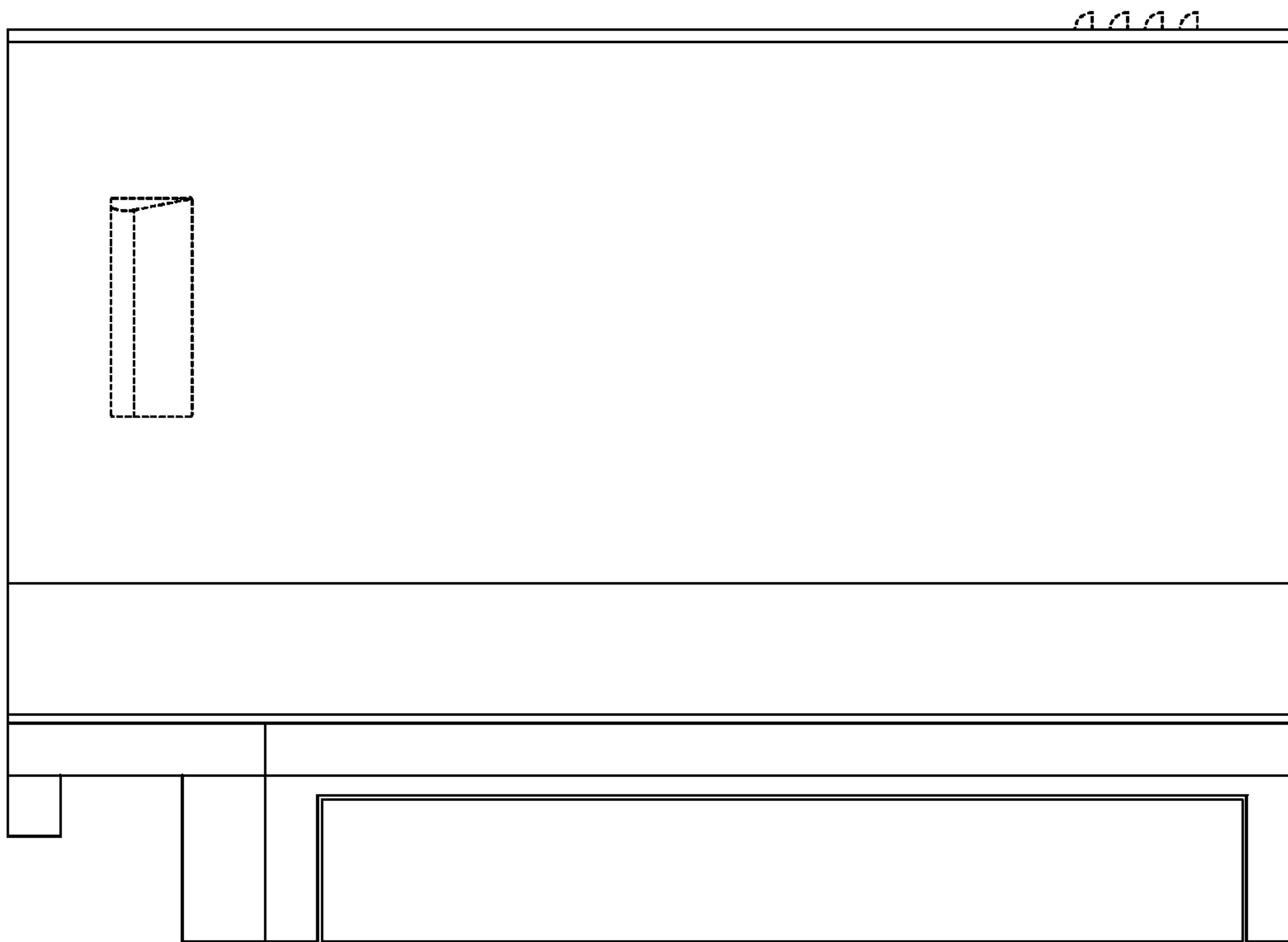

FIG.54

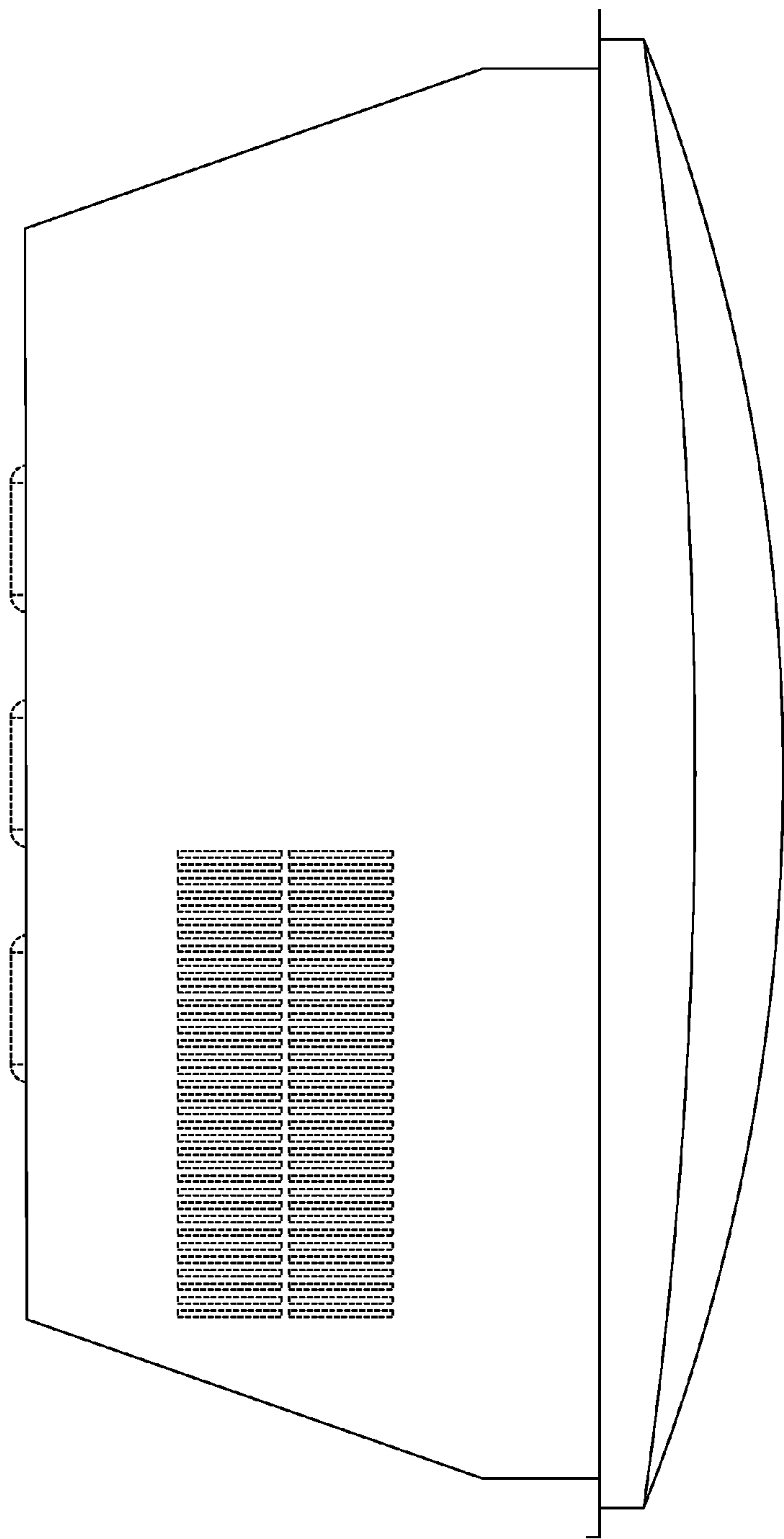

FIG. 55

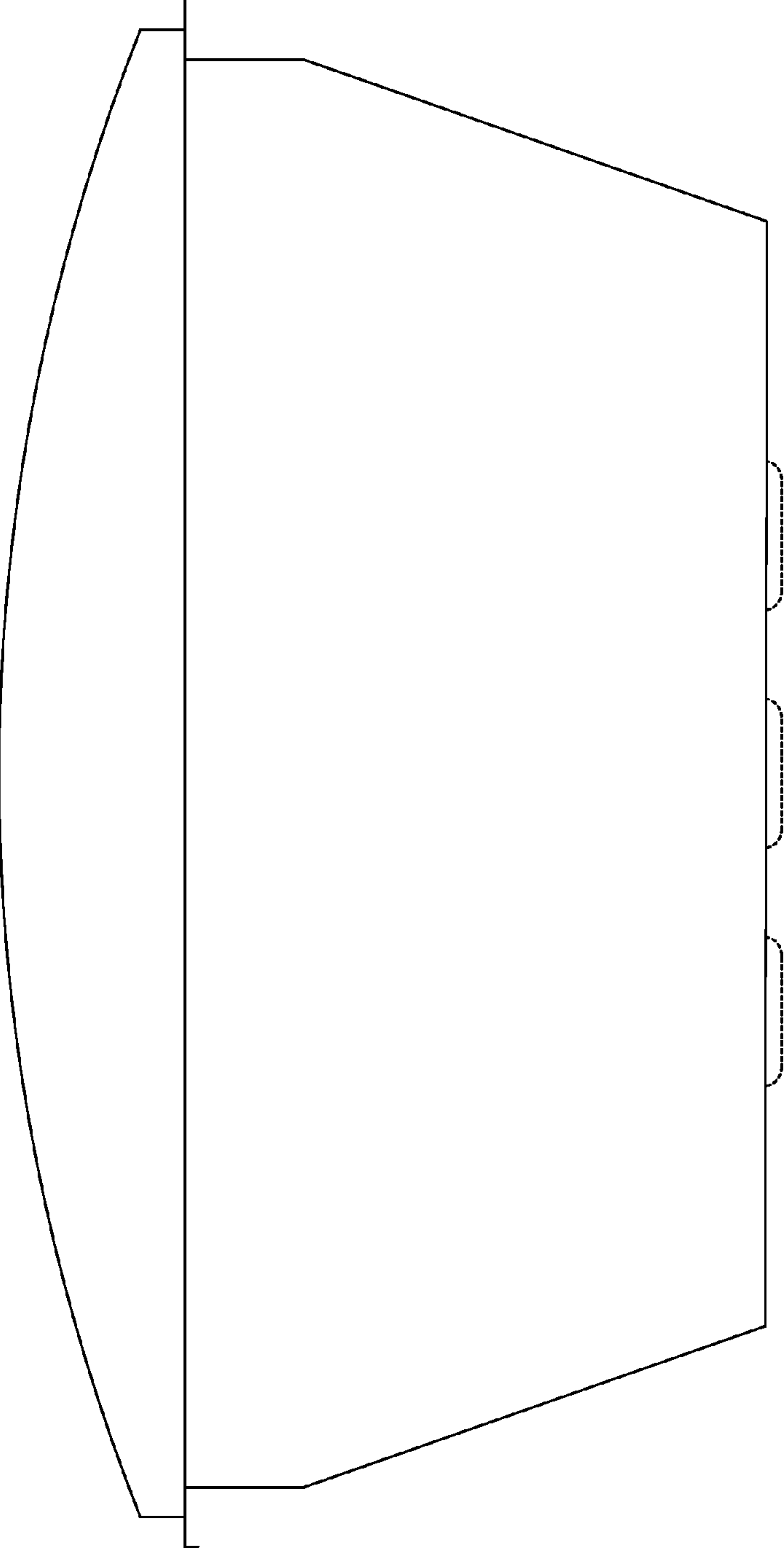

FIG.56

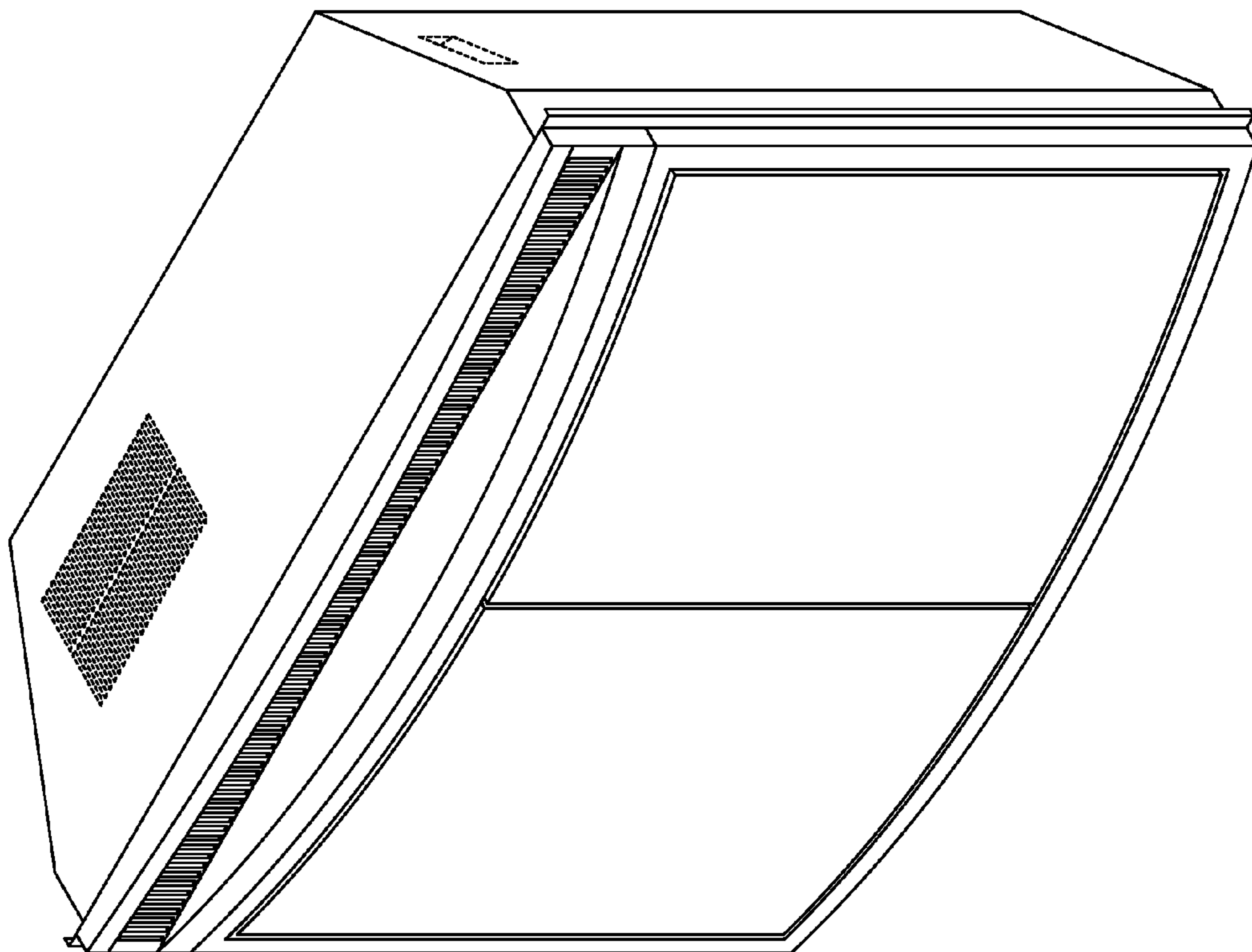

FIG.57

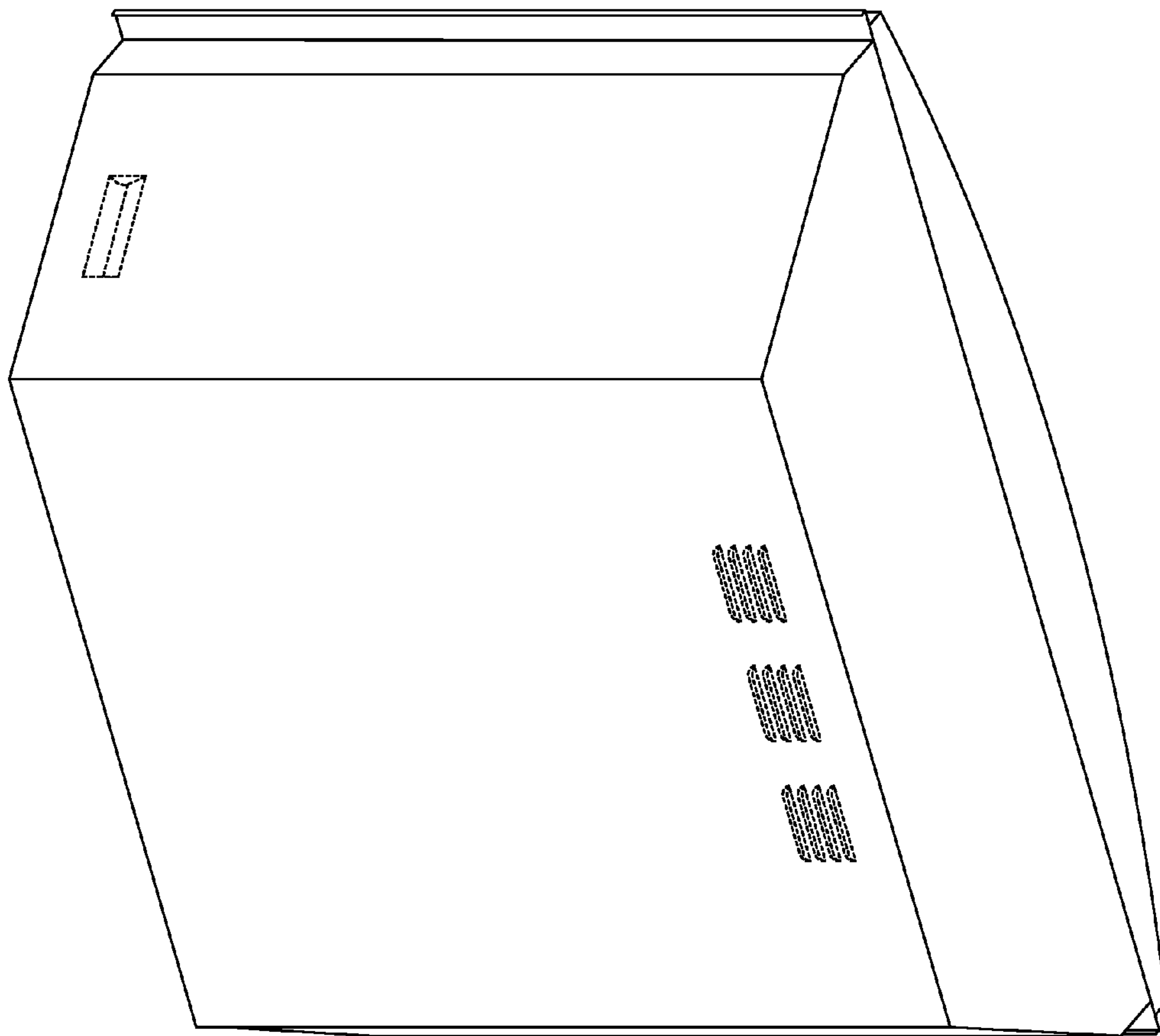

FIG.58



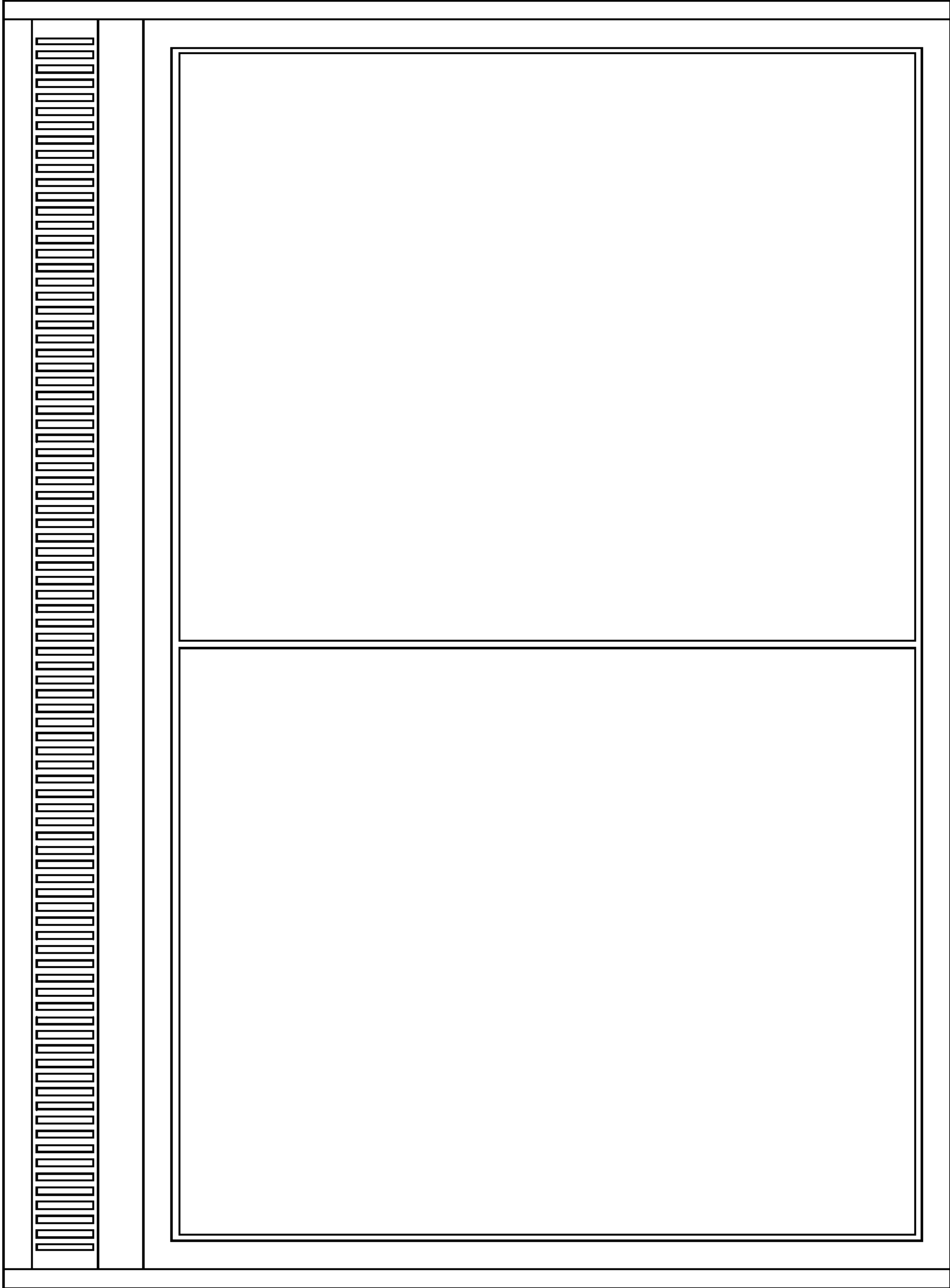

FIG.59

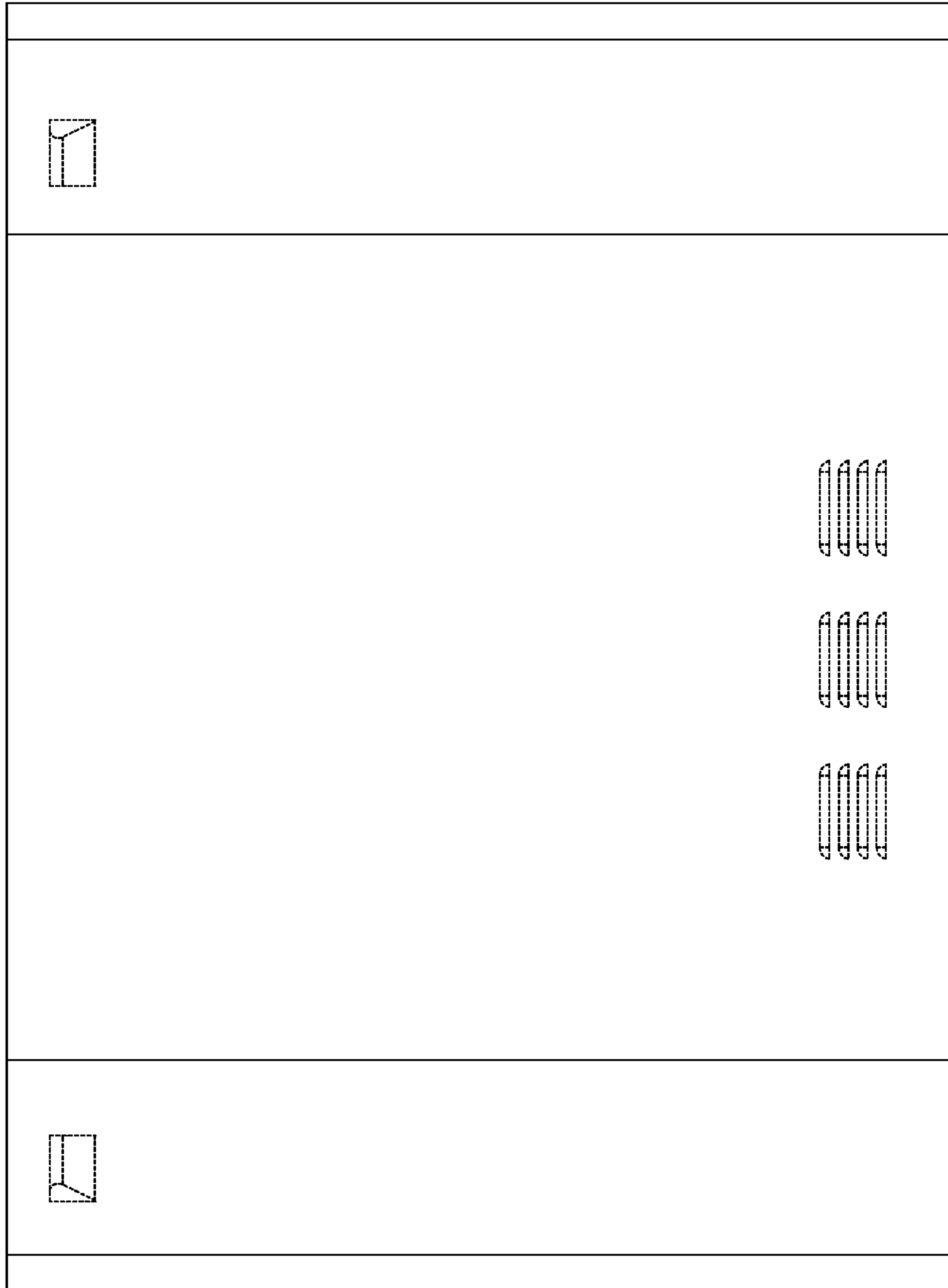

FIG. 60

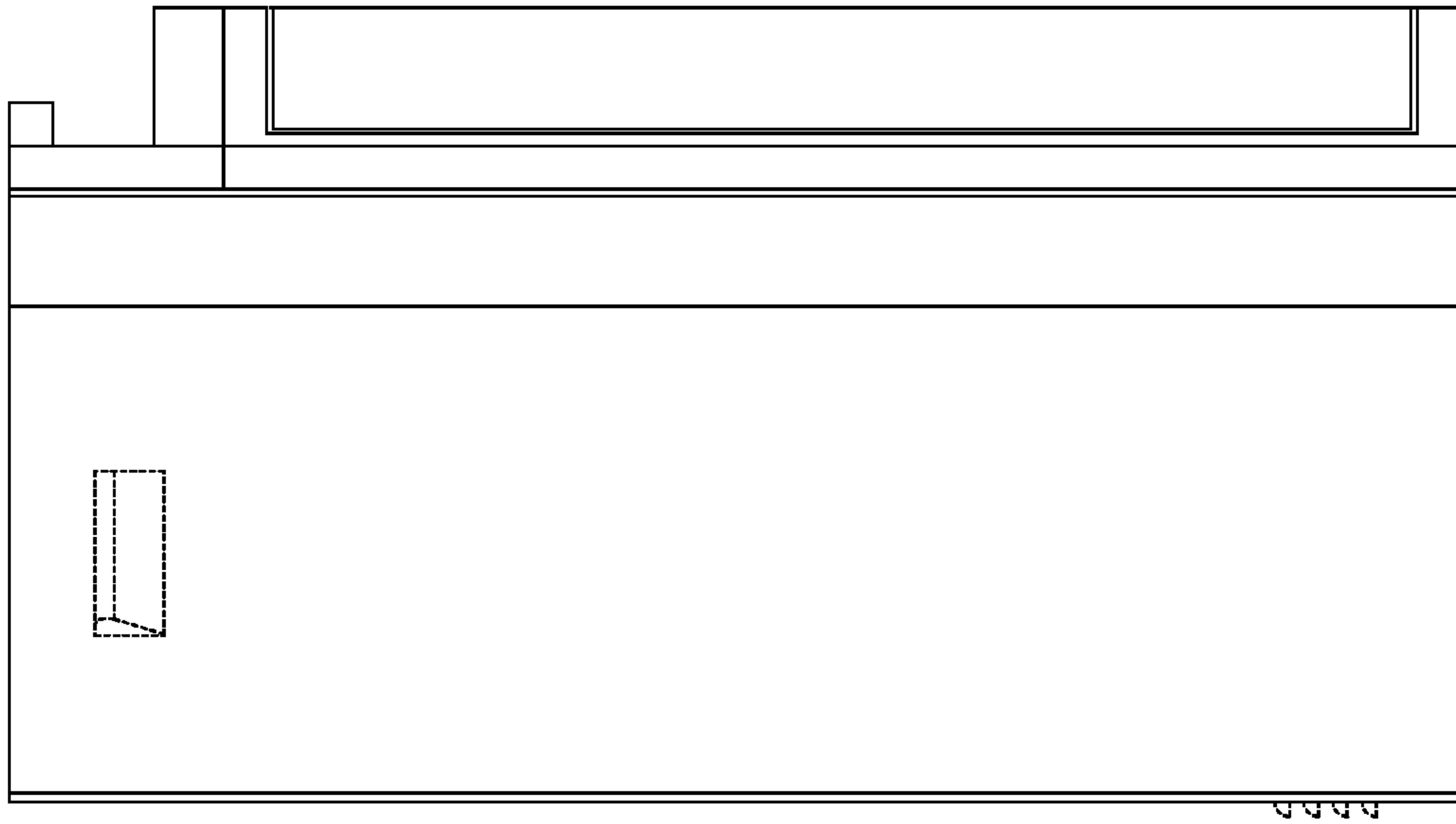

FIG.61

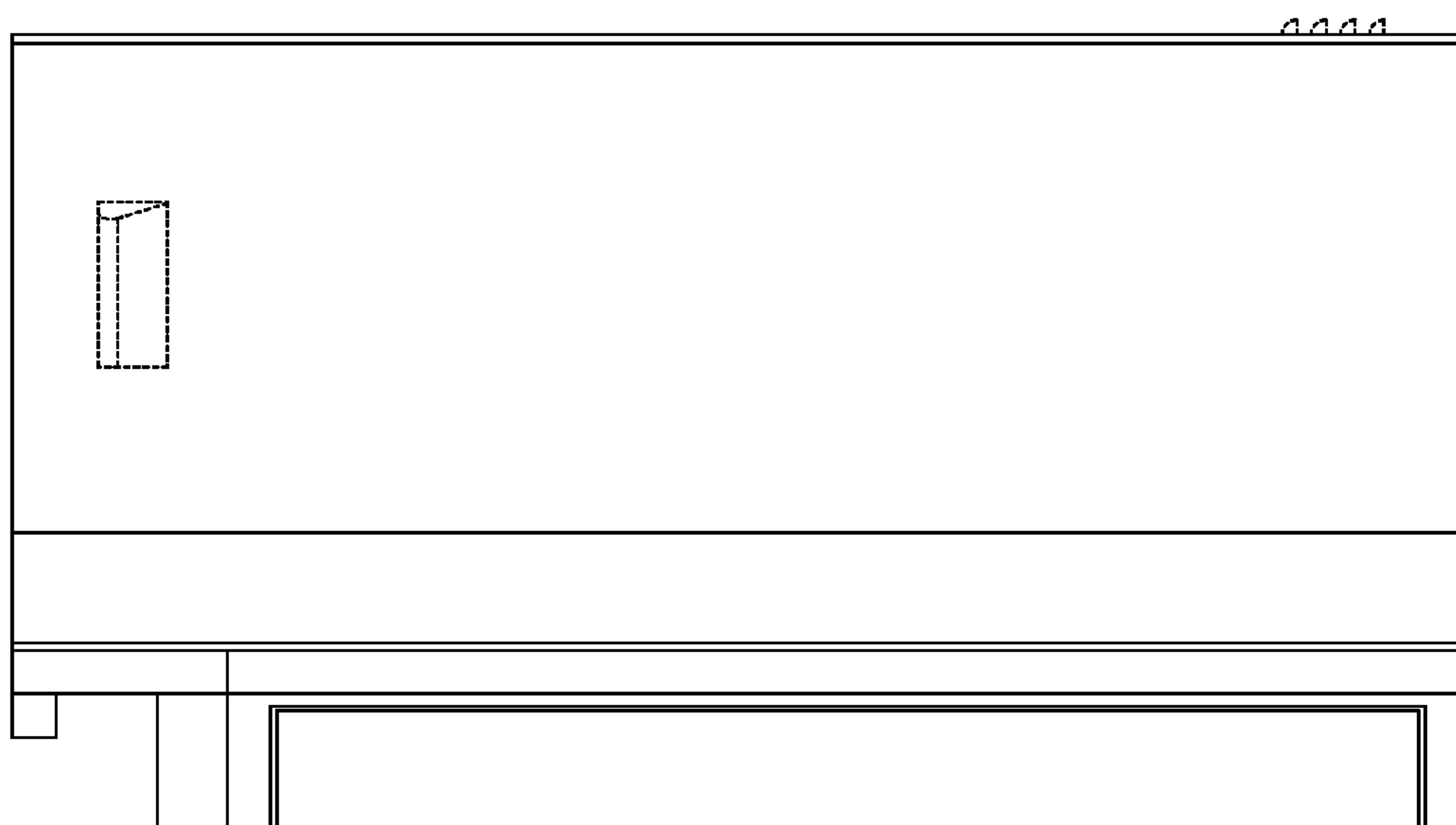

FIG. 62

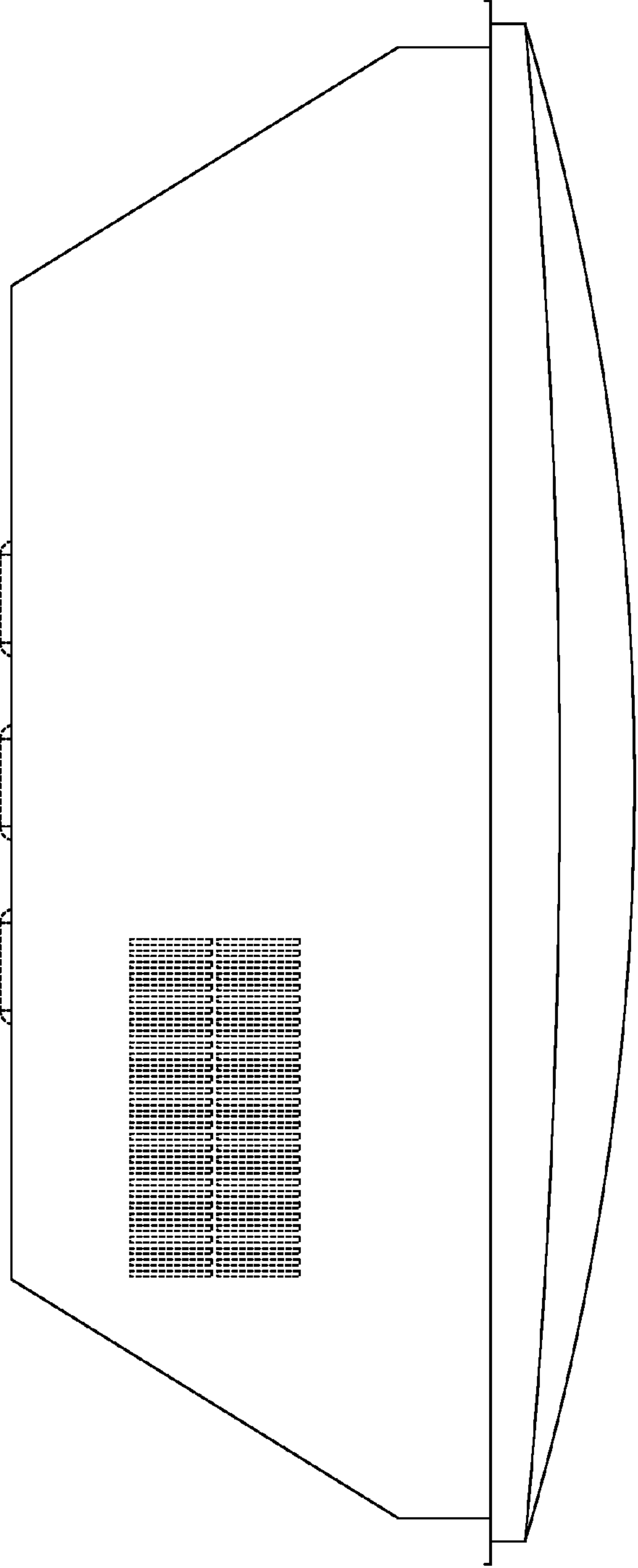

FIG. 63

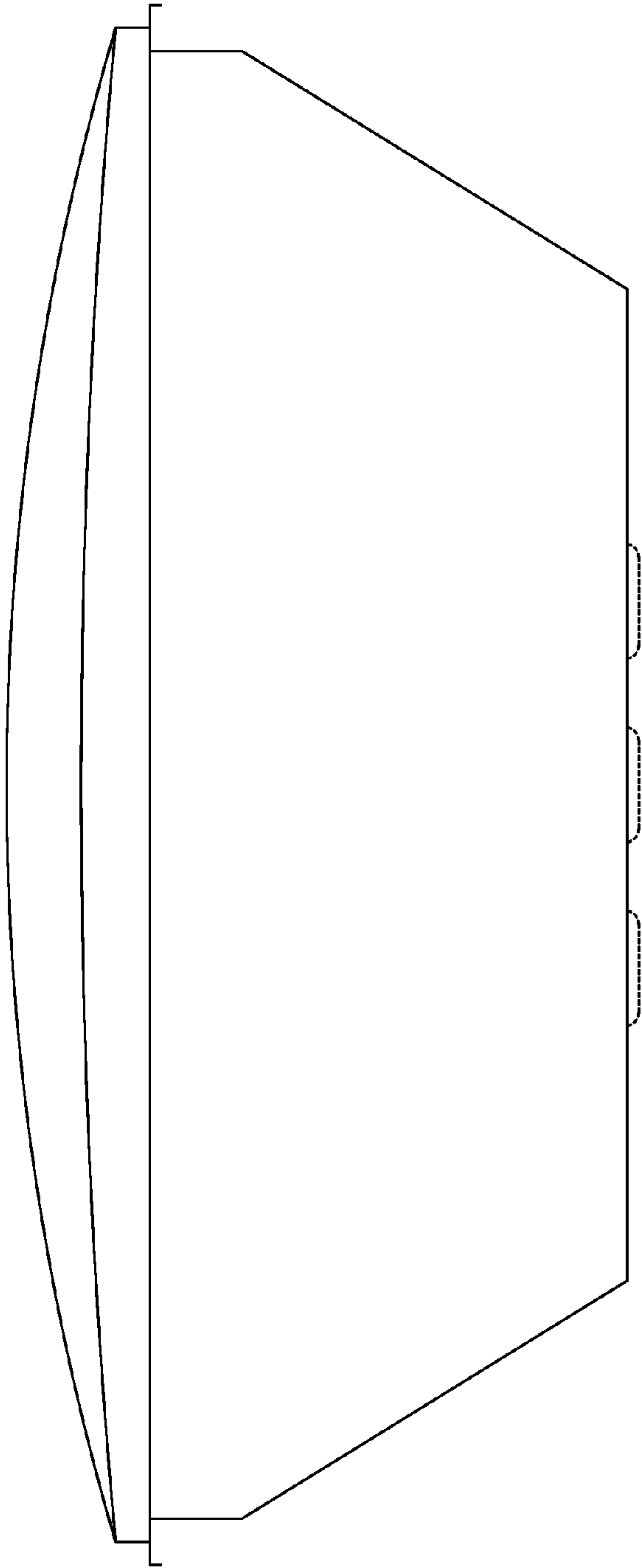

FIG. 64

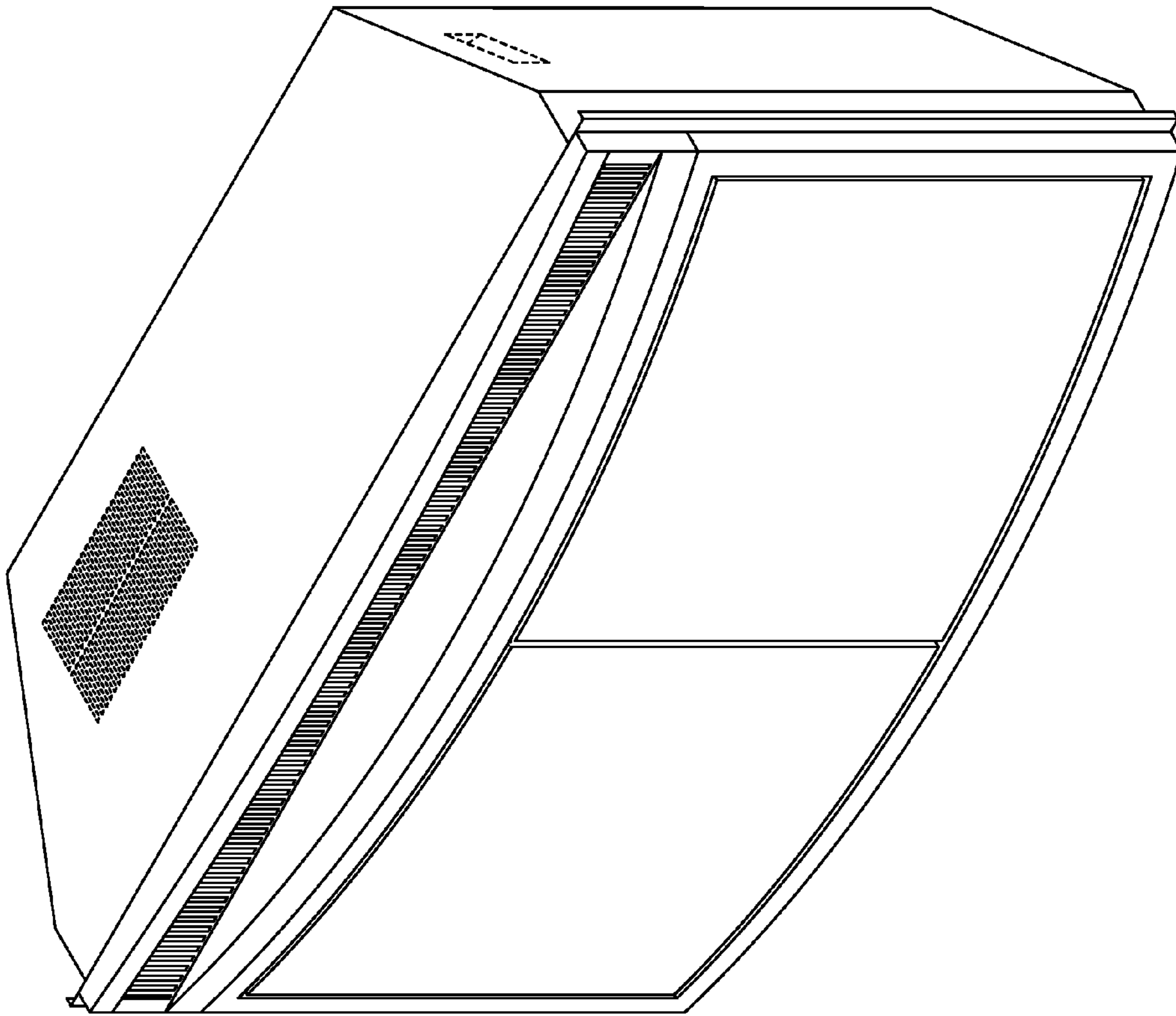

FIG.65

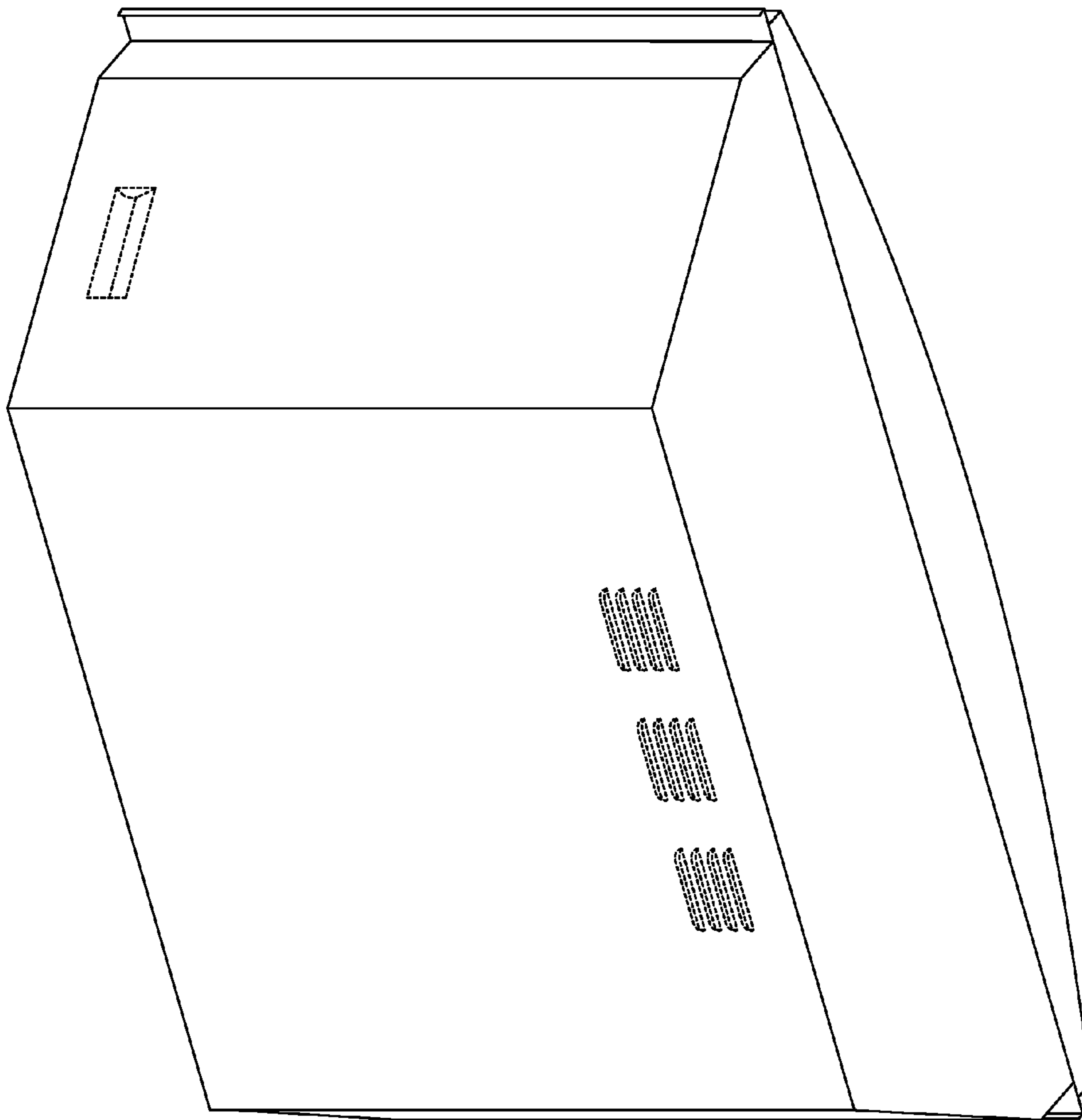

FIG. 66



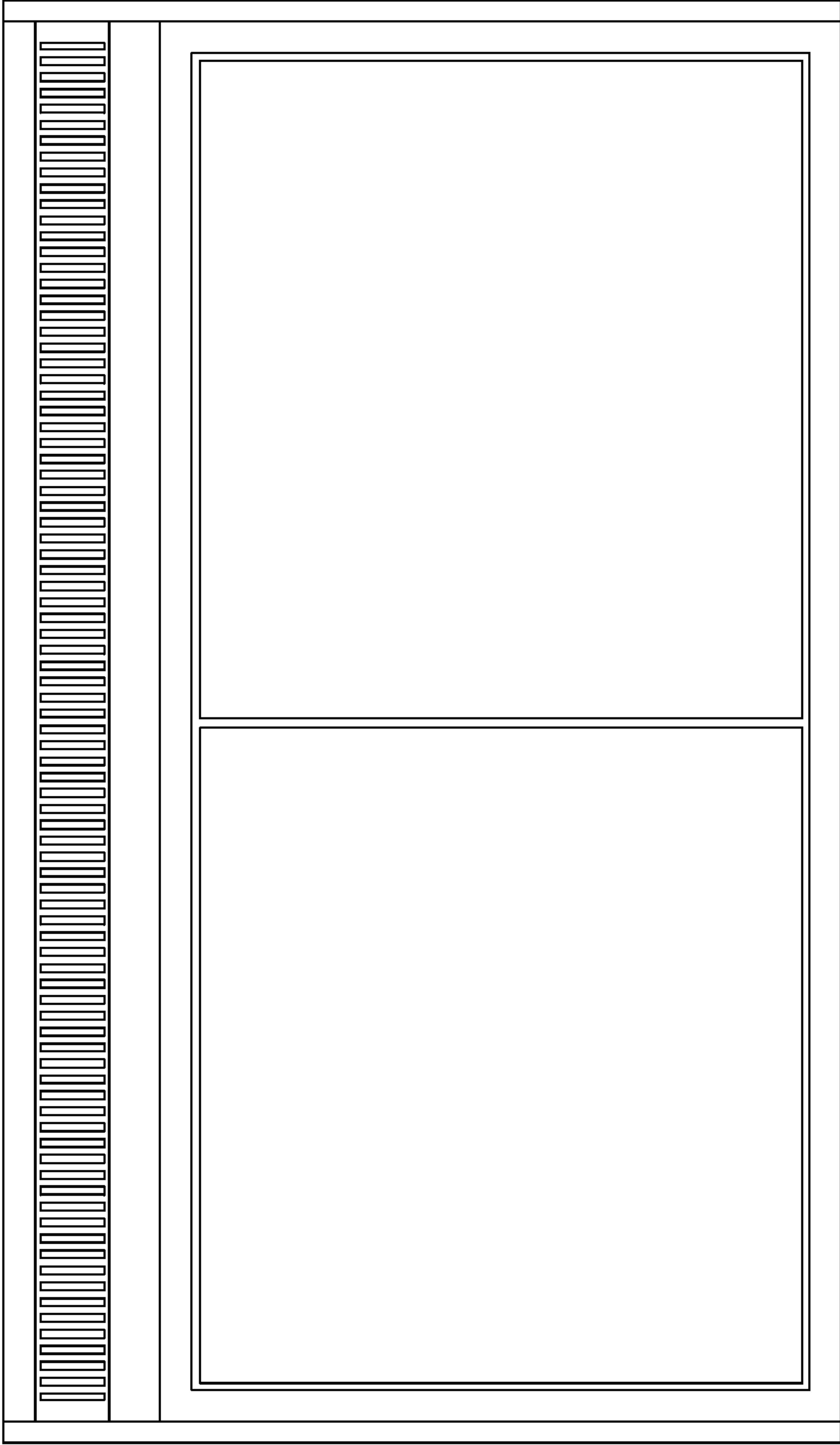

FIG.67

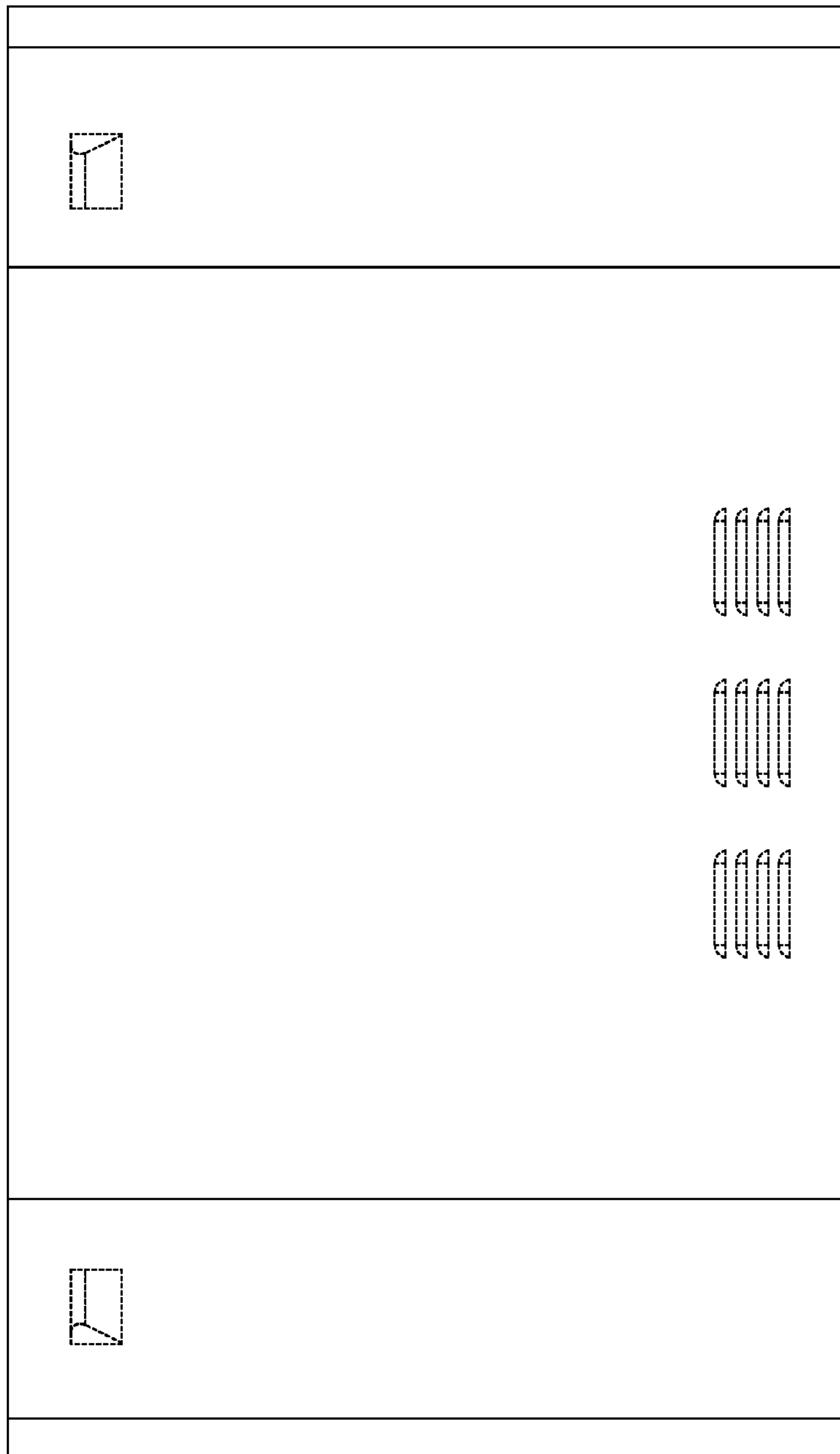

FIG.68

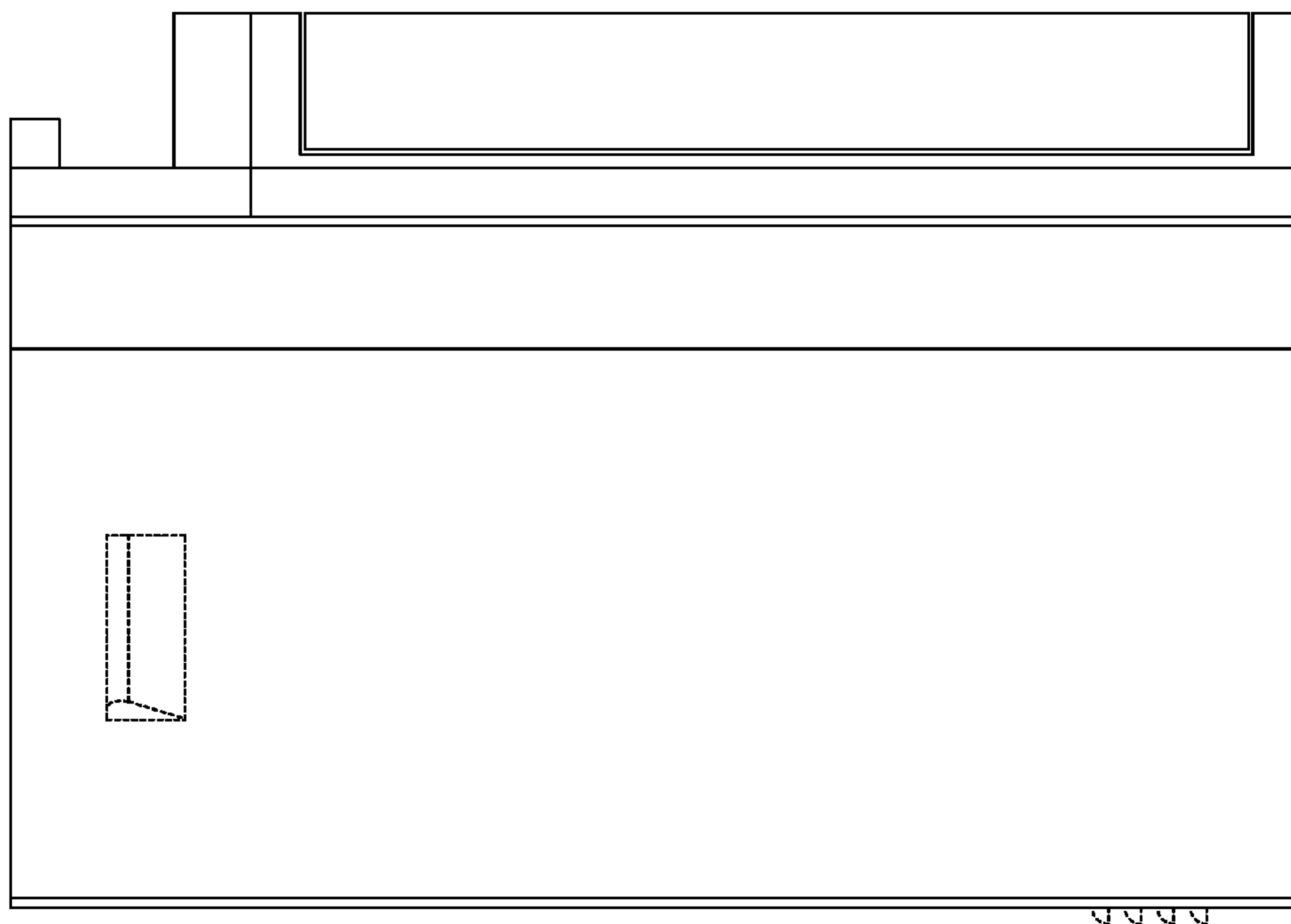

FIG. 69

6666

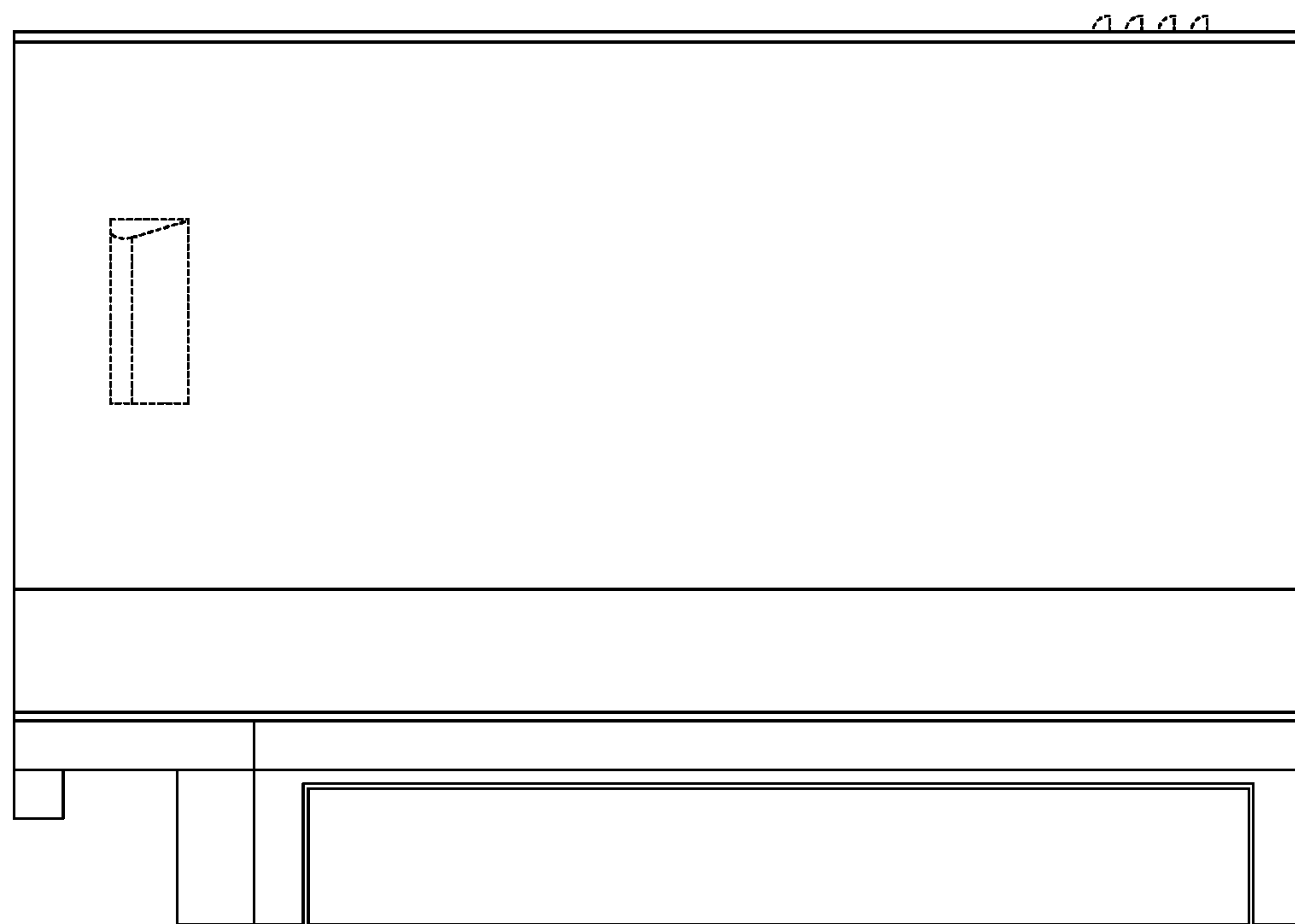

FIG.70

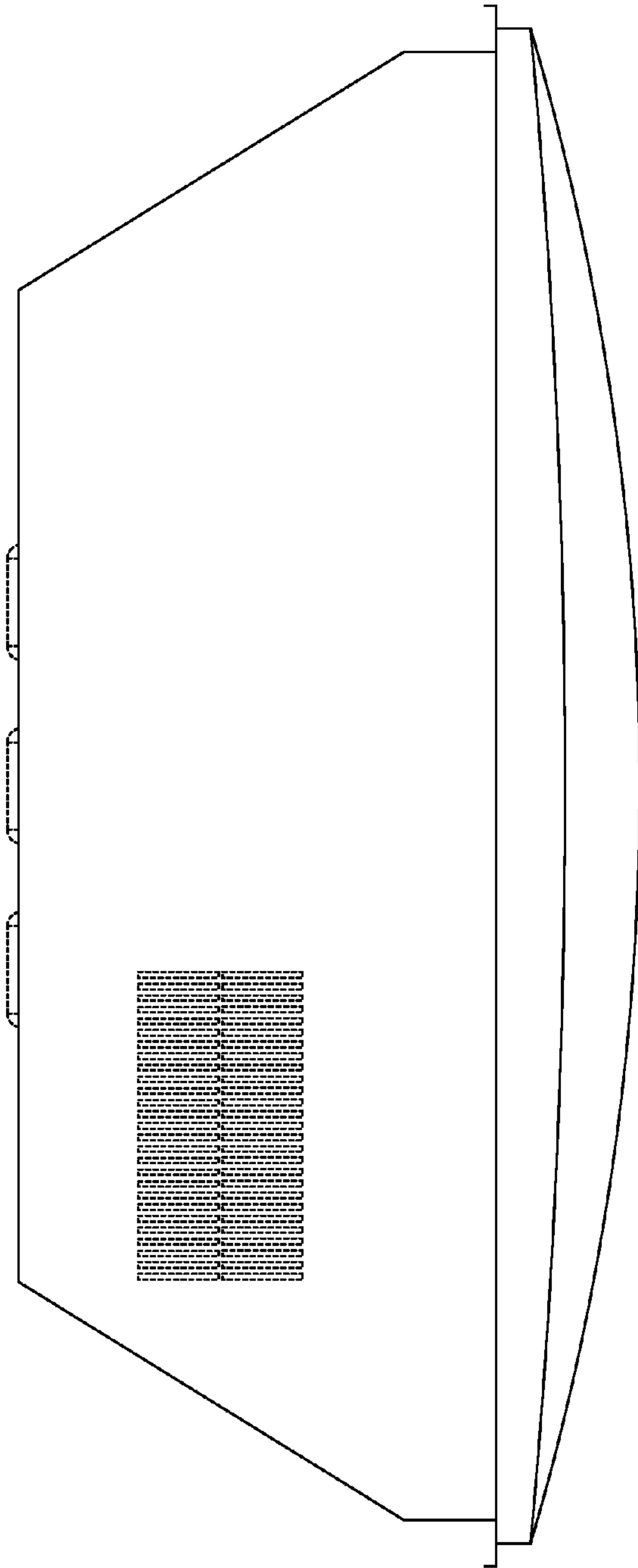

FIG.71

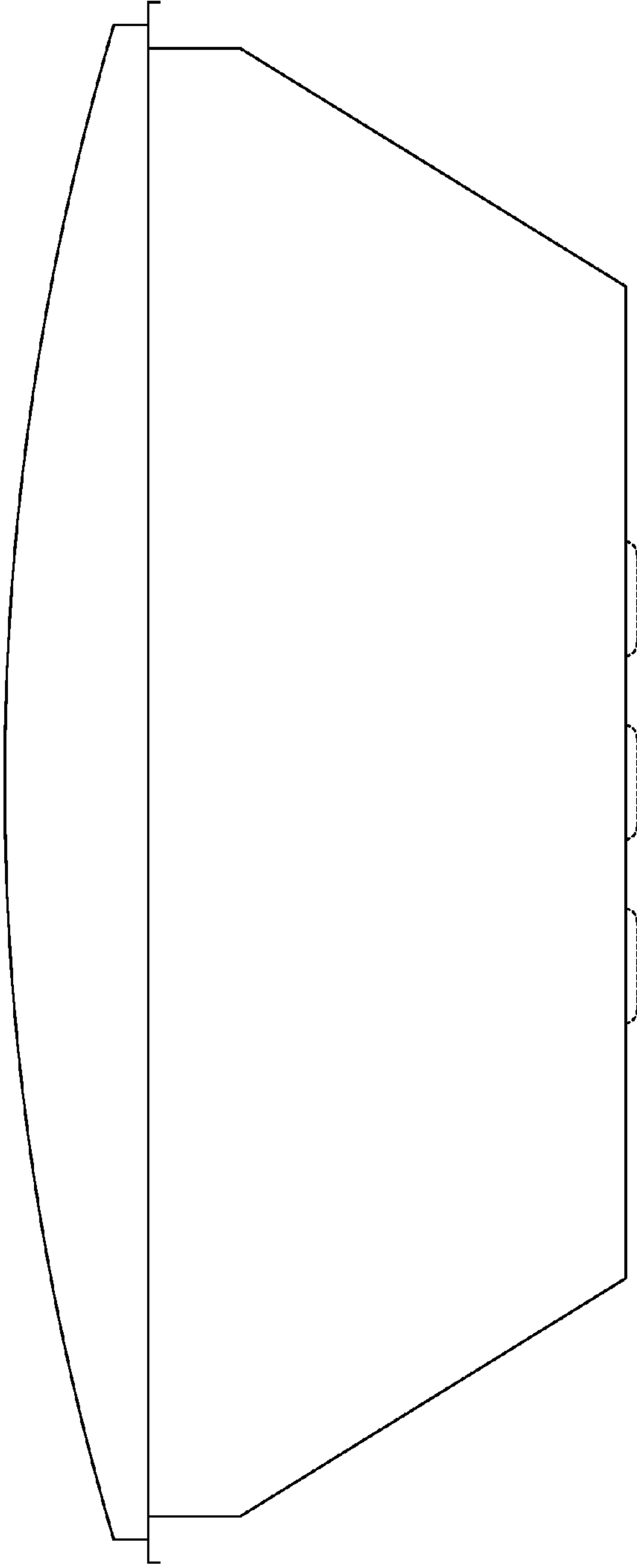

FIG.72

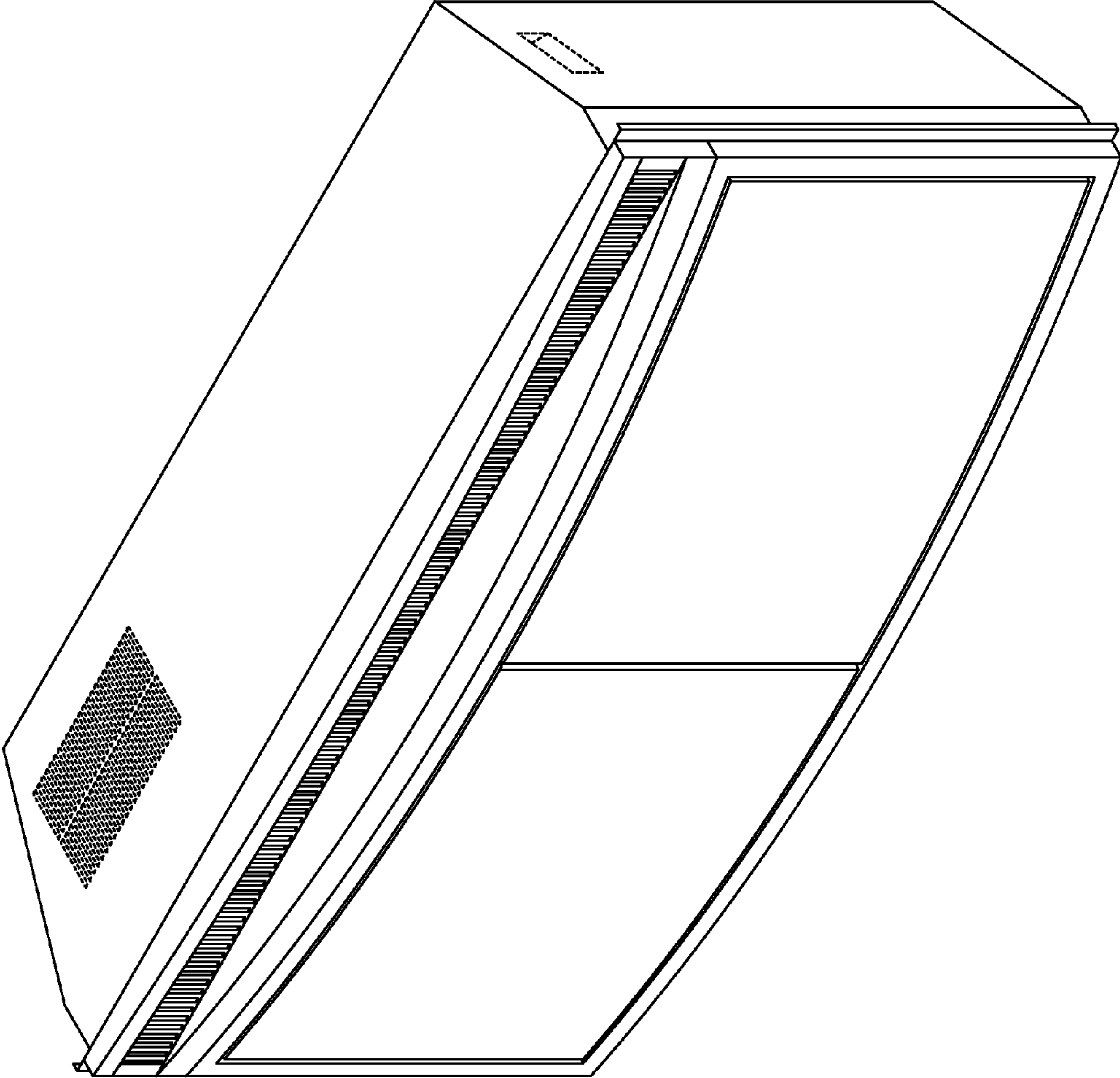

FIG. 73

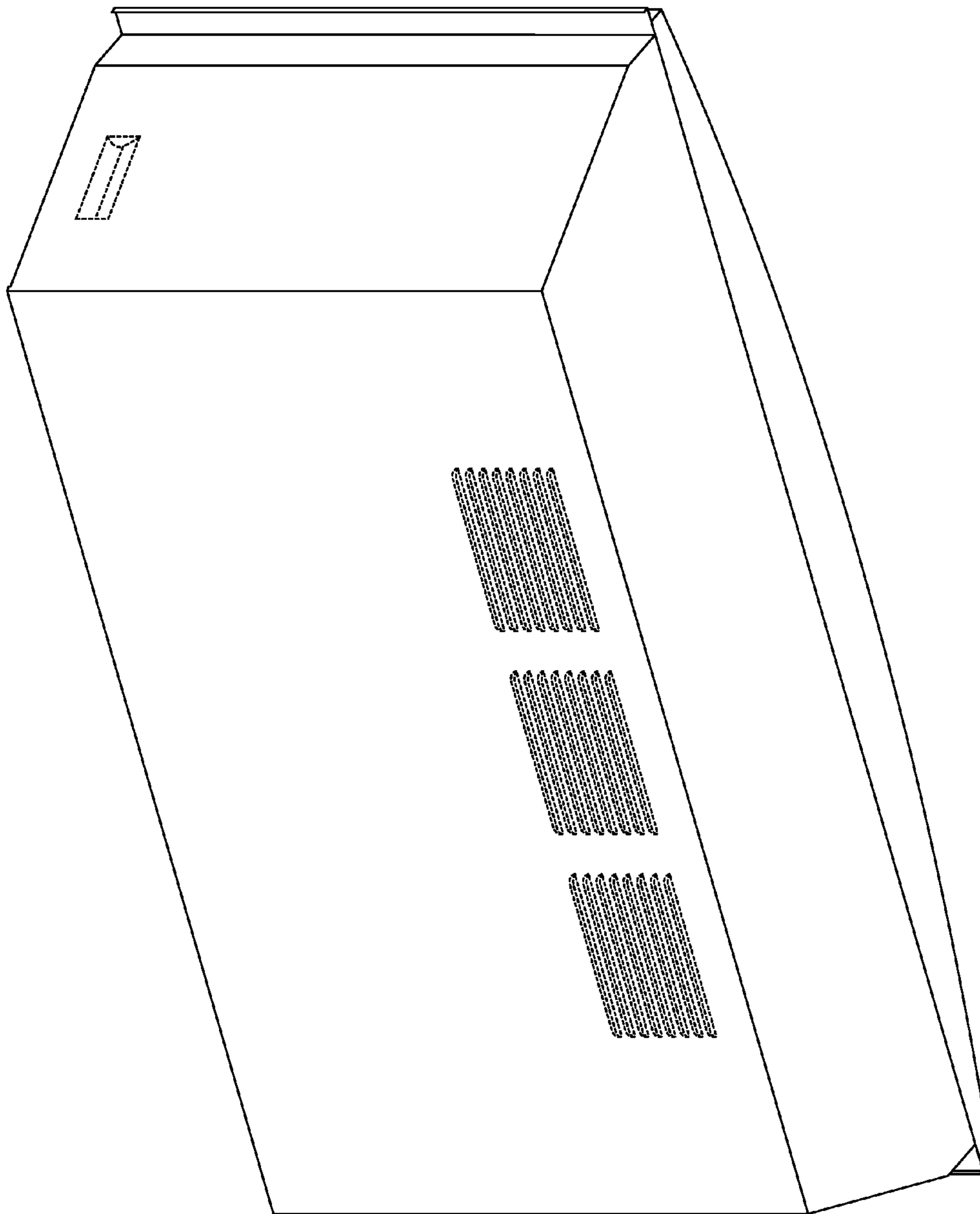

FIG.74



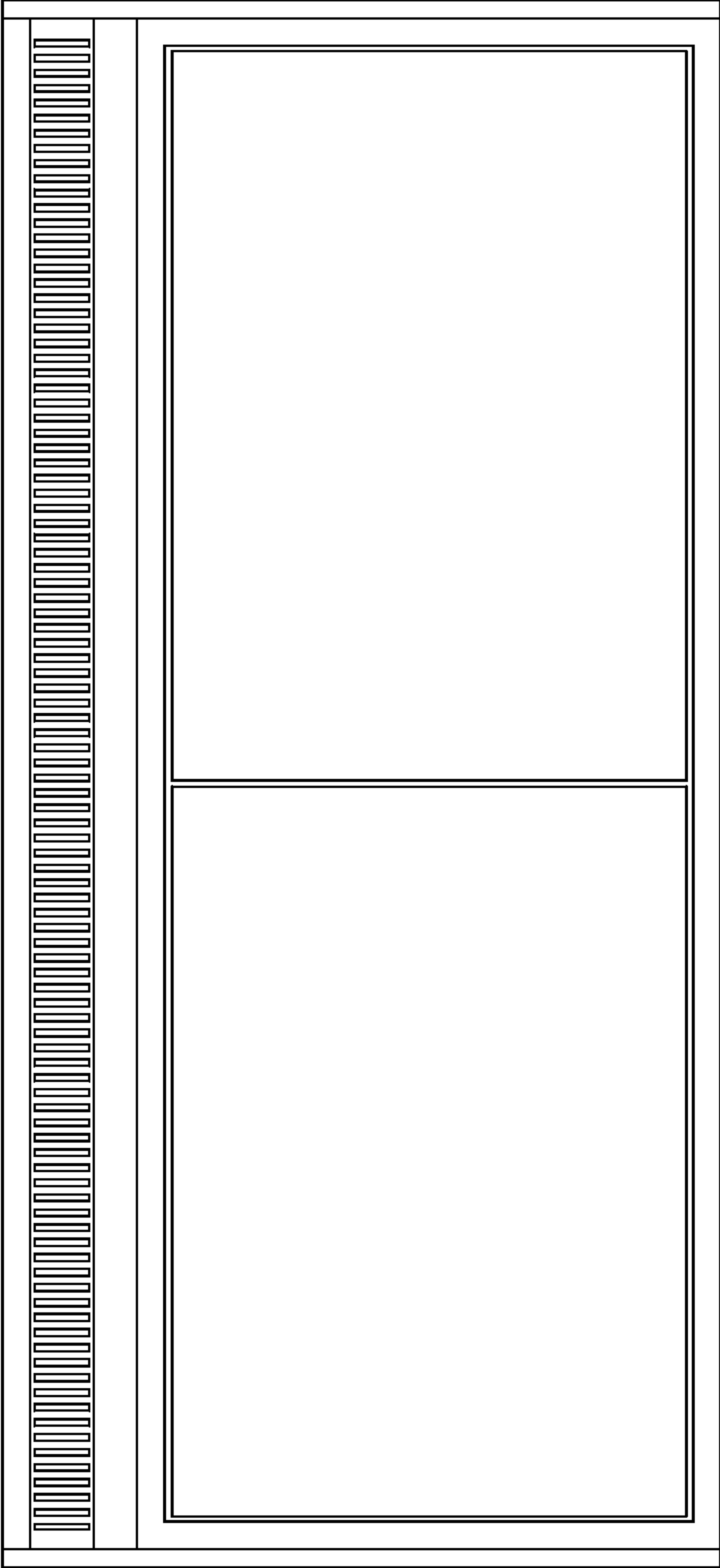

FIG.75

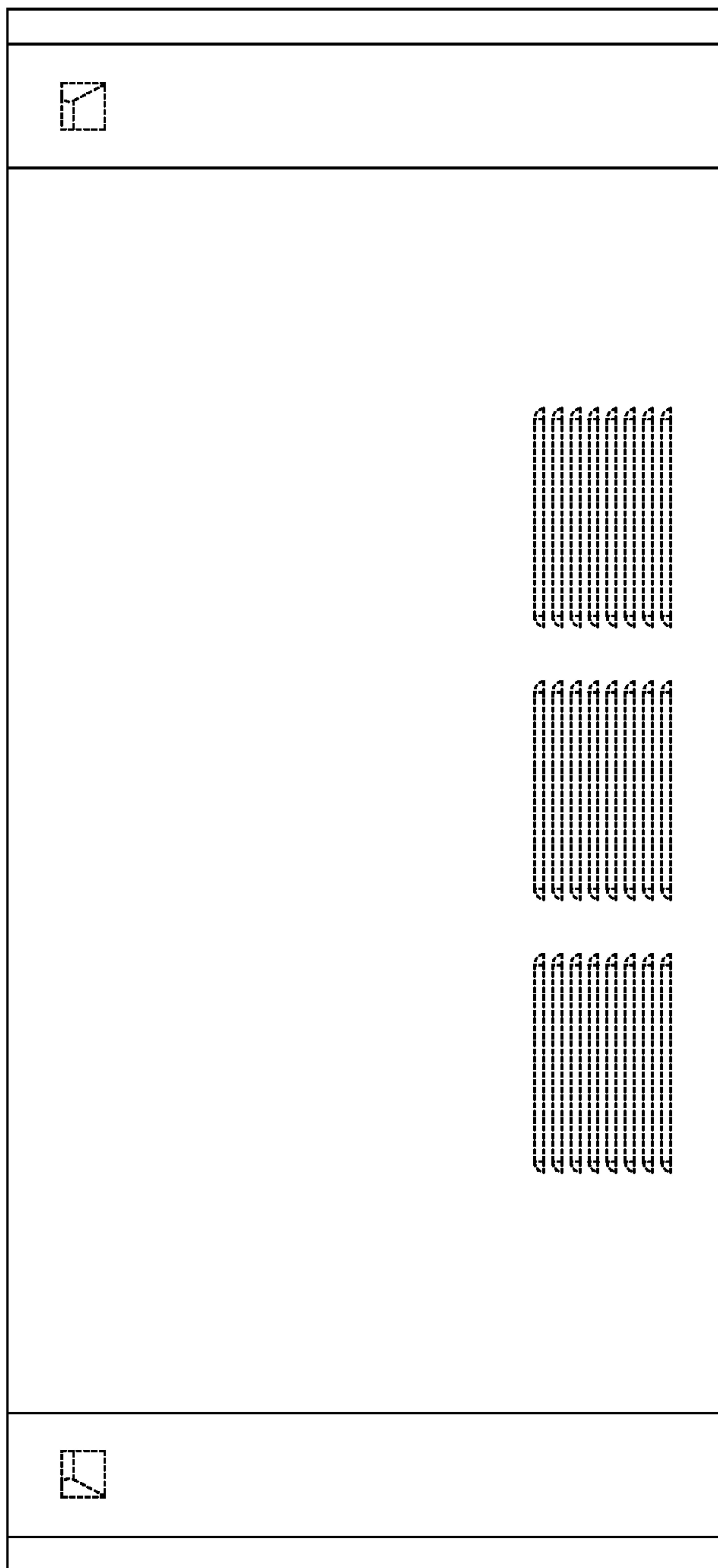

FIG.76

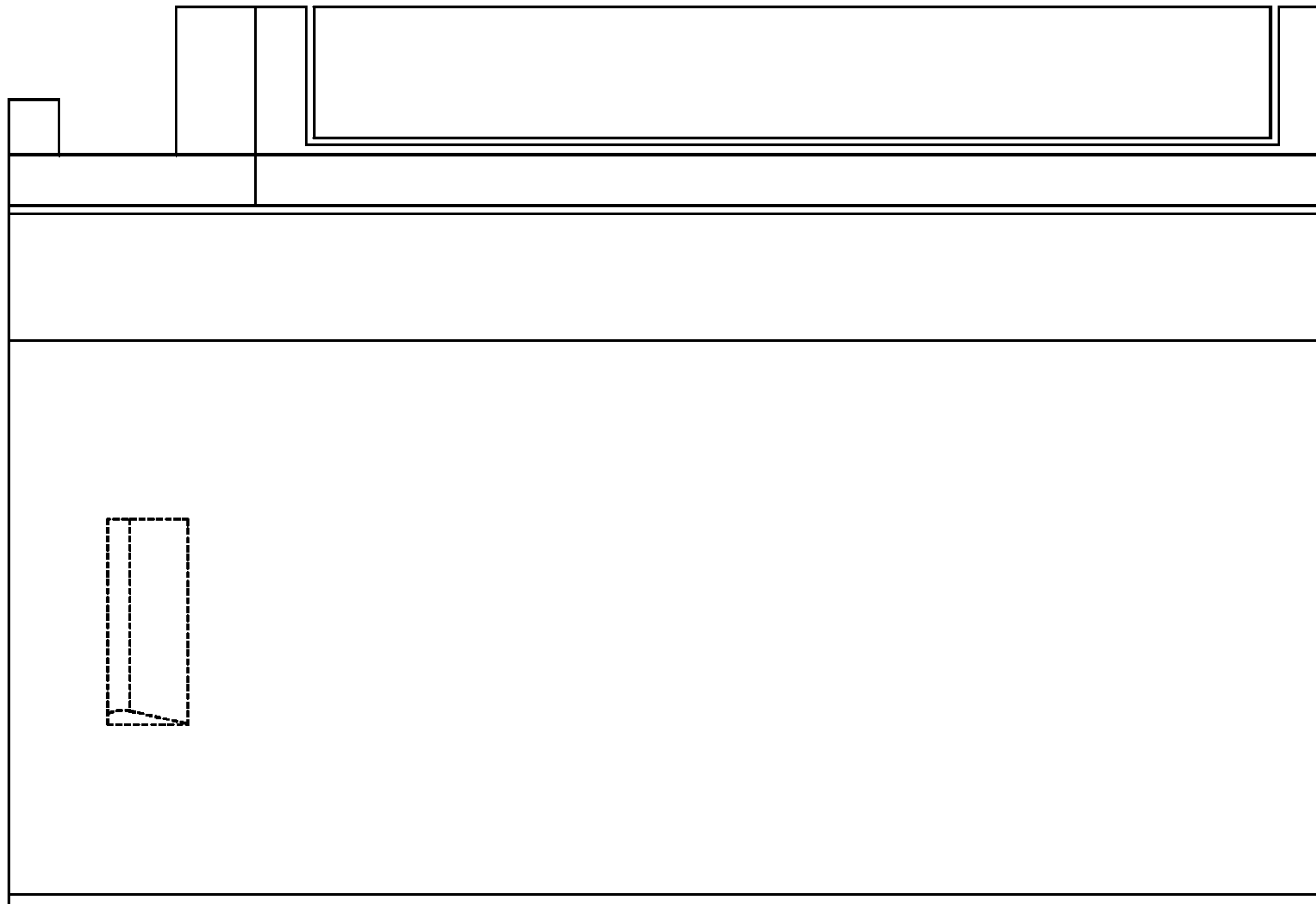

FIG.77

AAAAAAAAAA

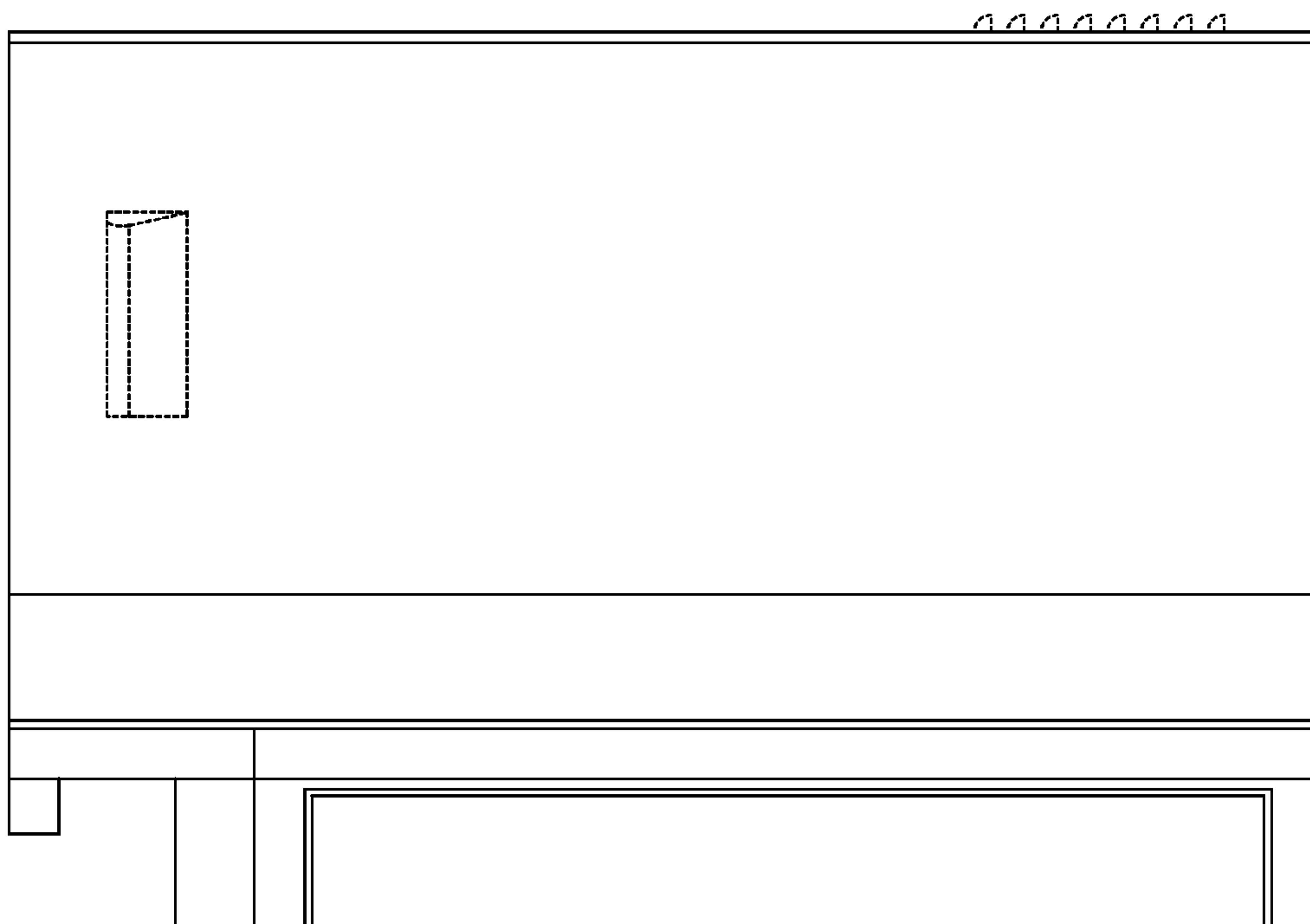

FIG.78

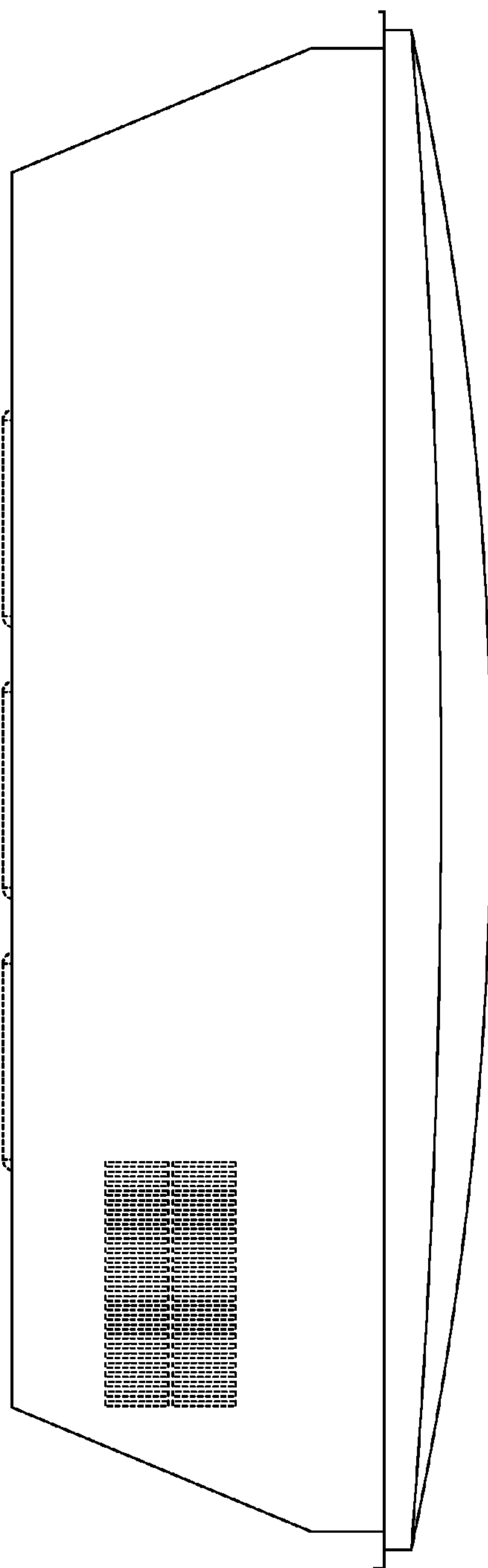

FIG.79

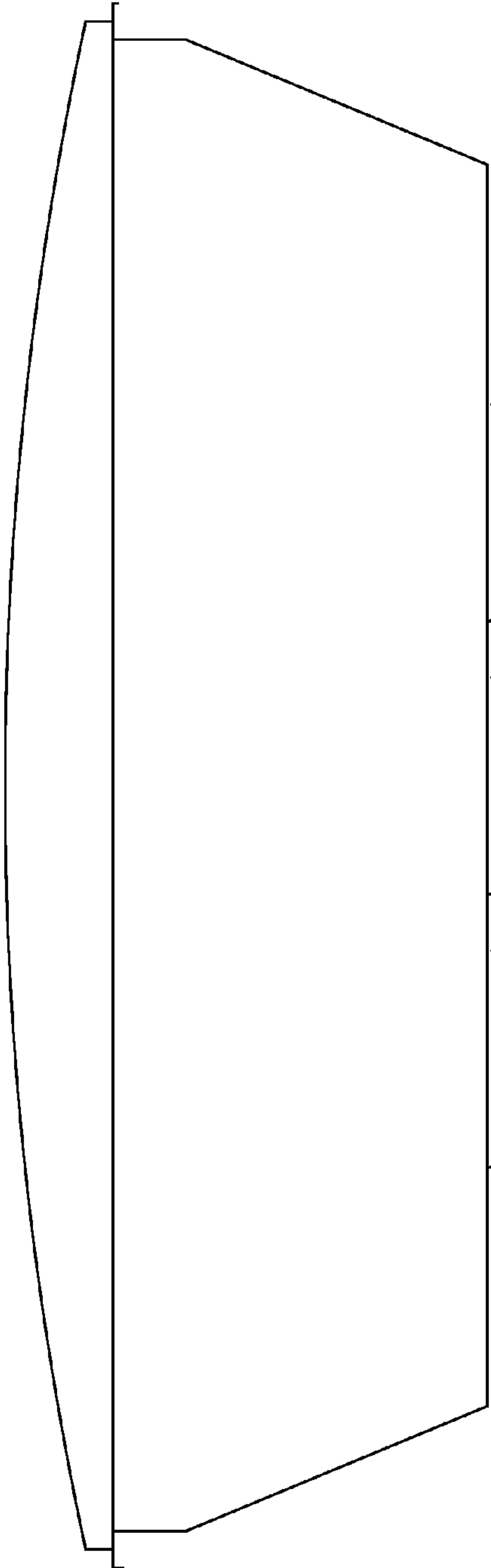

FIG.80

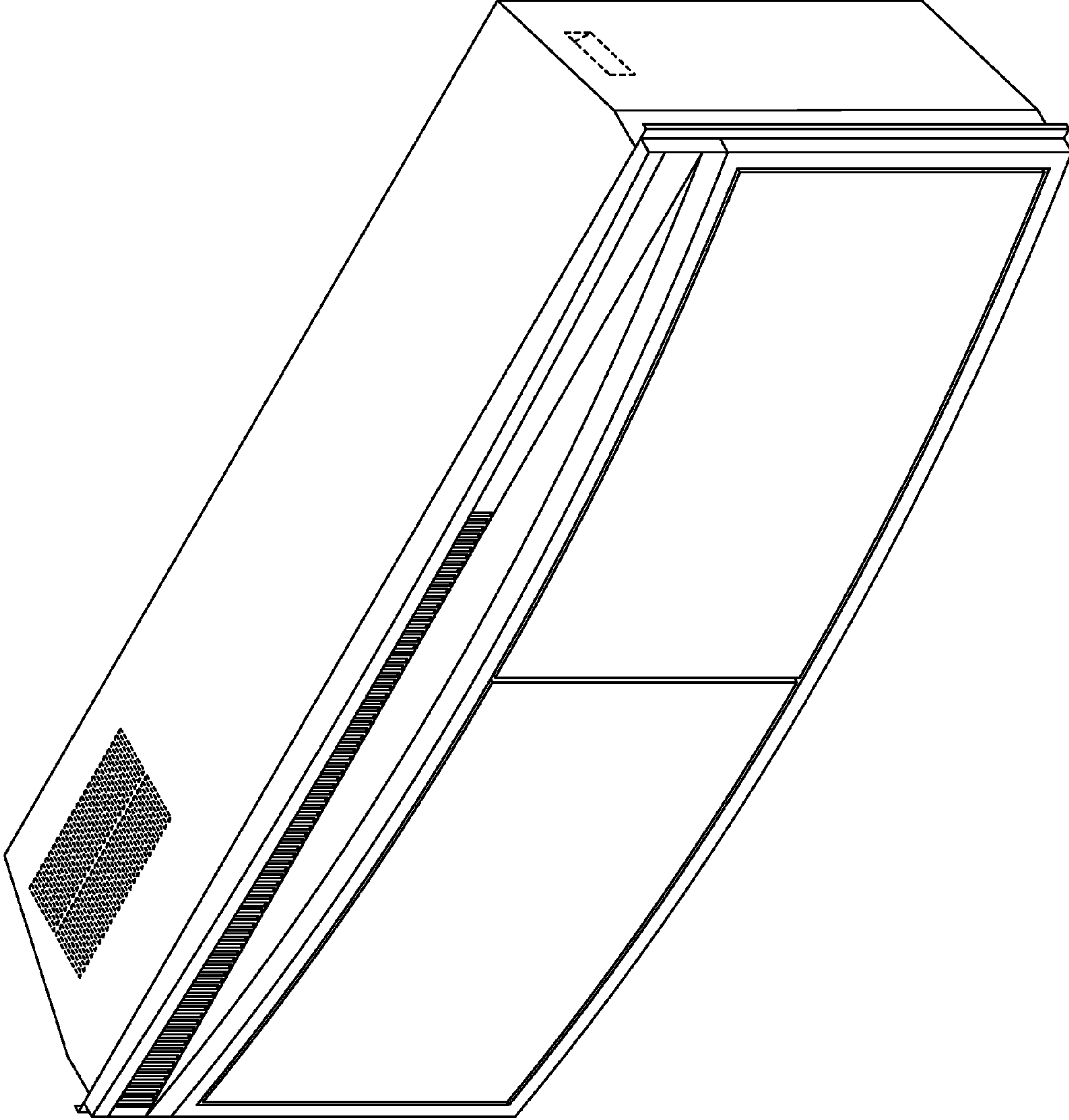

FIG.81

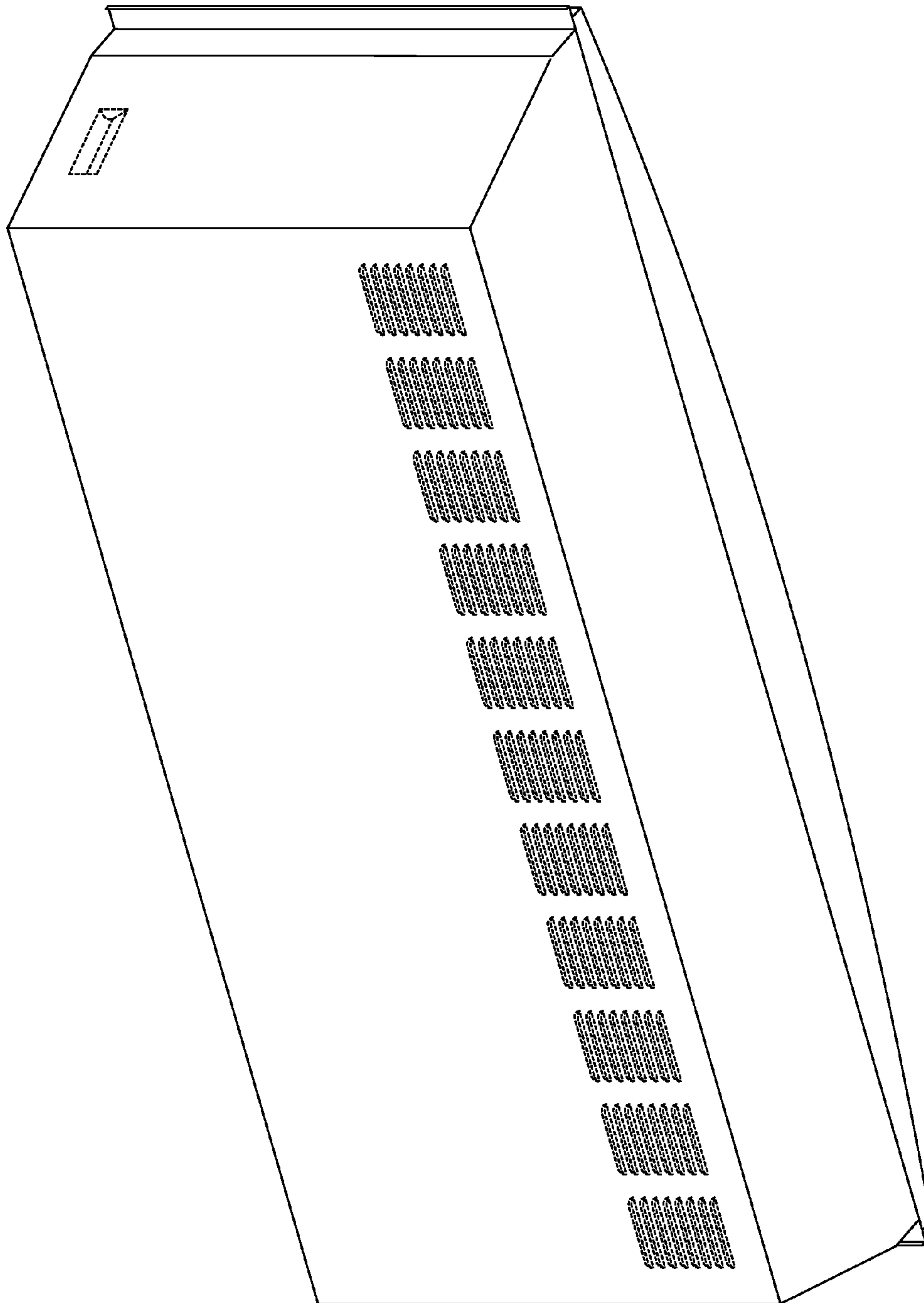

FIG.82



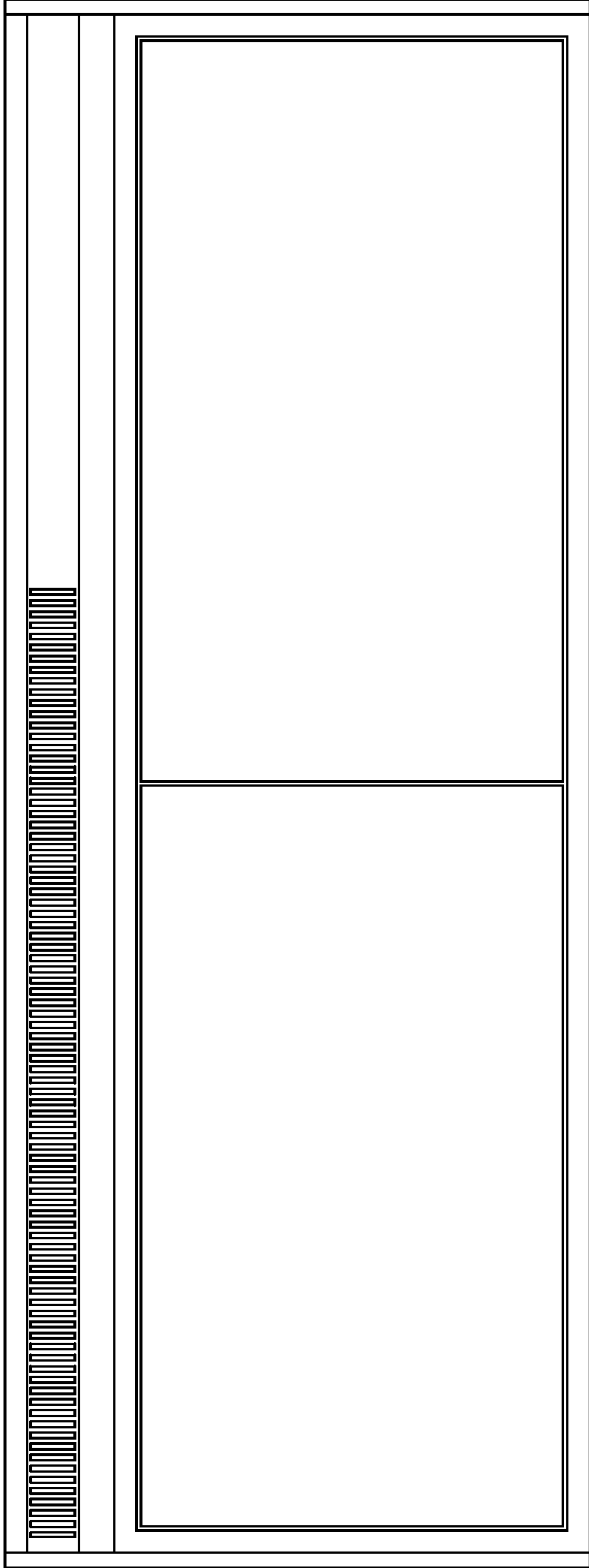

FIG.83

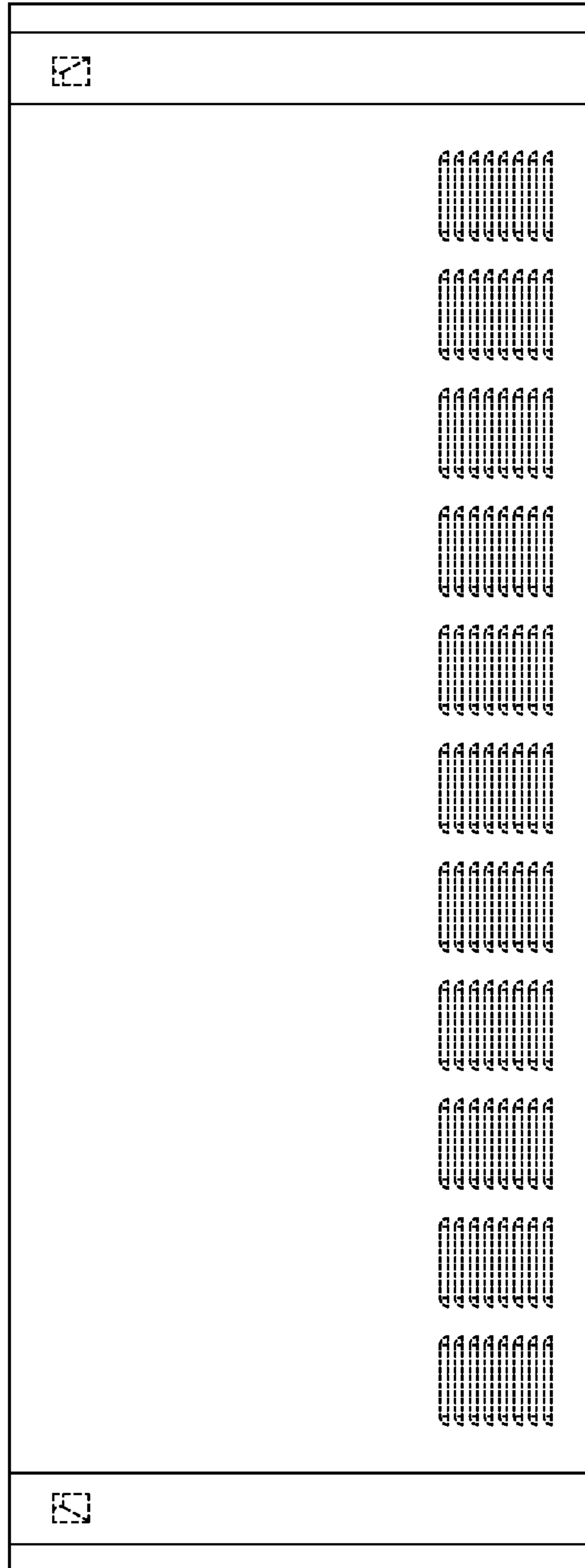

FIG.84



FIG.85

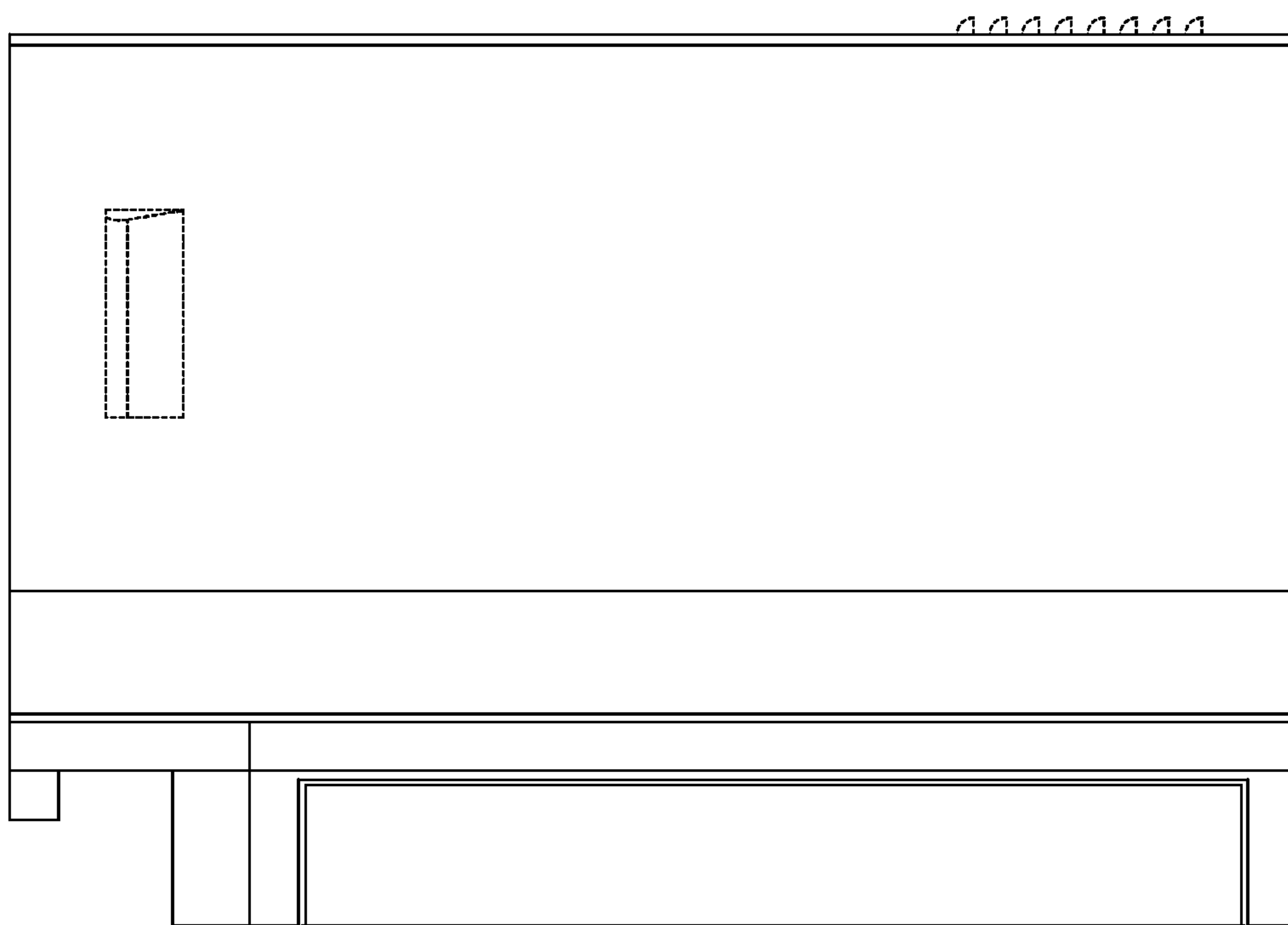

FIG.86

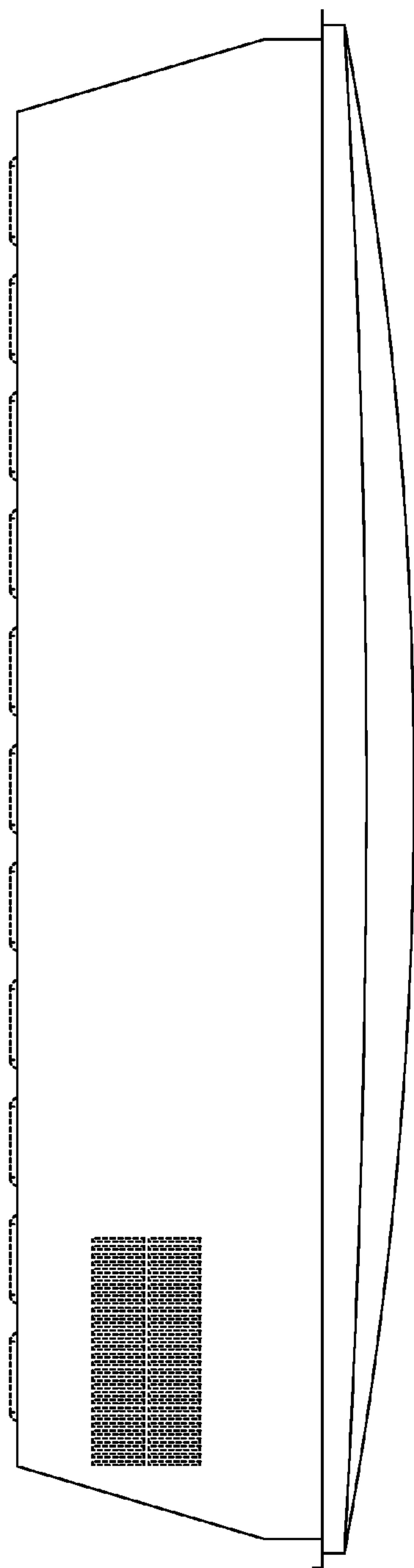

FIG. 87

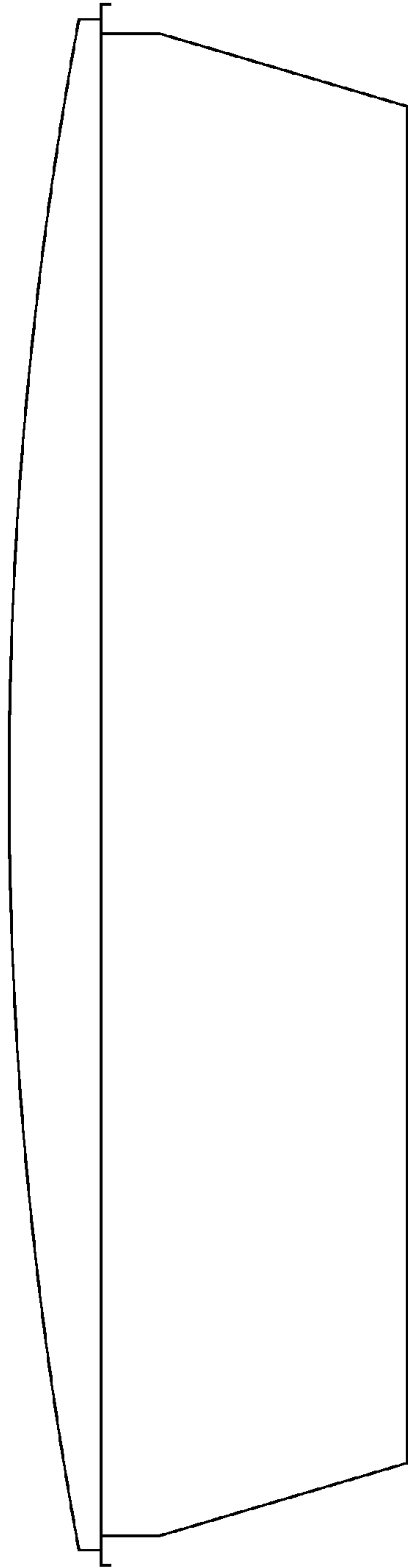

FIG. 88