



US00D671195S

(12) **United States Design Patent**  
**Huang**

(10) **Patent No.:** **US D671,195 S**

(45) **Date of Patent:** **\*\* Nov. 20, 2012**

(54) **WALL-MOUNTED FAUCET HANDLE**

(75) Inventor: **Li-Chen Huang**, Changhua-Hsien (TW)

(73) Assignee: **Alexander Yeh Industry Co., Ltd.**,  
Changhua Hsien (TW)

(\*\*) Term: **14 Years**

(21) Appl. No.: **29/397,936**

(22) Filed: **Jul. 22, 2011**

(51) **LOC (9) Cl.** ..... **23-01**

(52) **U.S. Cl.** ..... **D23/252**

(58) **Field of Classification Search** ..... D23/238-242,  
D23/250-252; 4/675-678; 137/801

See application file for complete search history.

(56) **References Cited**

**U.S. PATENT DOCUMENTS**

D388,158 S \* 12/1997 Doughty et al. .... D23/238  
D586,432 S \* 2/2009 Schoenherr et al. .... D23/252

D621,005 S \* 8/2010 Bouroullec et al. .... D23/238  
D628,277 S \* 11/2010 Montgomery ..... D23/252

\* cited by examiner

*Primary Examiner* — Robert Delehanty

(57) **CLAIM**

The ornamental design for a wall-mounted faucet handle, as shown and described.

**DESCRIPTION**

FIG. 1 is an upper perspective view of a wall-mounted faucet handle showing my new design;

FIG. 2 is a front view of the embodiment shown in FIG. 1;

FIG. 3 is a rear view of the embodiment shown in FIG. 1;

FIG. 4 is a left side view of the embodiment shown in FIG. 1;

FIG. 5 is a right side view of the embodiment shown in FIG. 1;

FIG. 6 is a top view of the embodiment shown in FIG. 1;

FIG. 7 is a bottom view of the embodiment shown in FIG. 1; and,

FIG. 8 is a perspective schematic view illustrating an application of a wallmounted faucet handle showing my design.

The broken lines in FIGS. 1 to 8 are for illustrative purposes only and form no part of the claimed design.

**1 Claim, 8 Drawing Sheets**

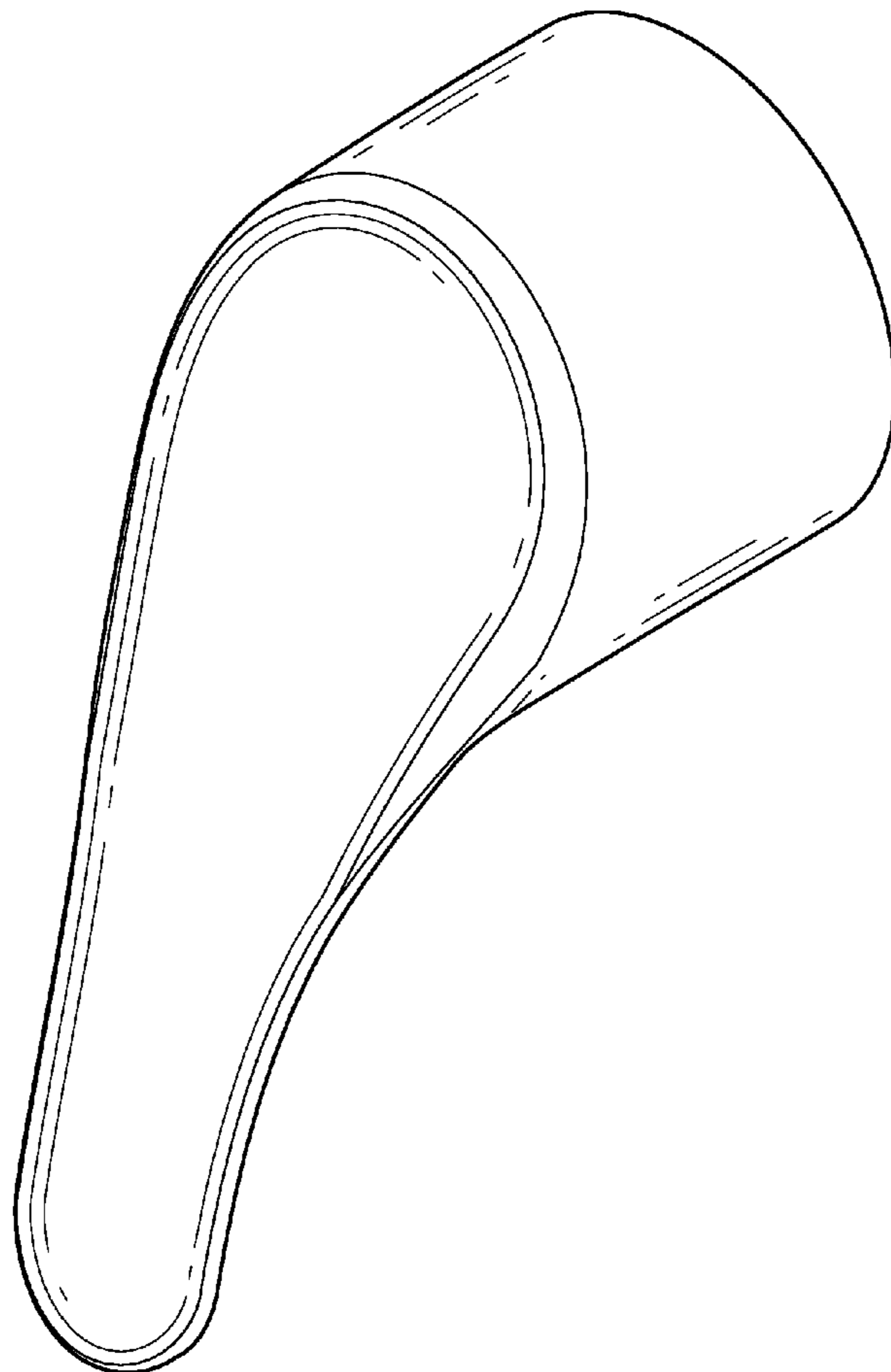

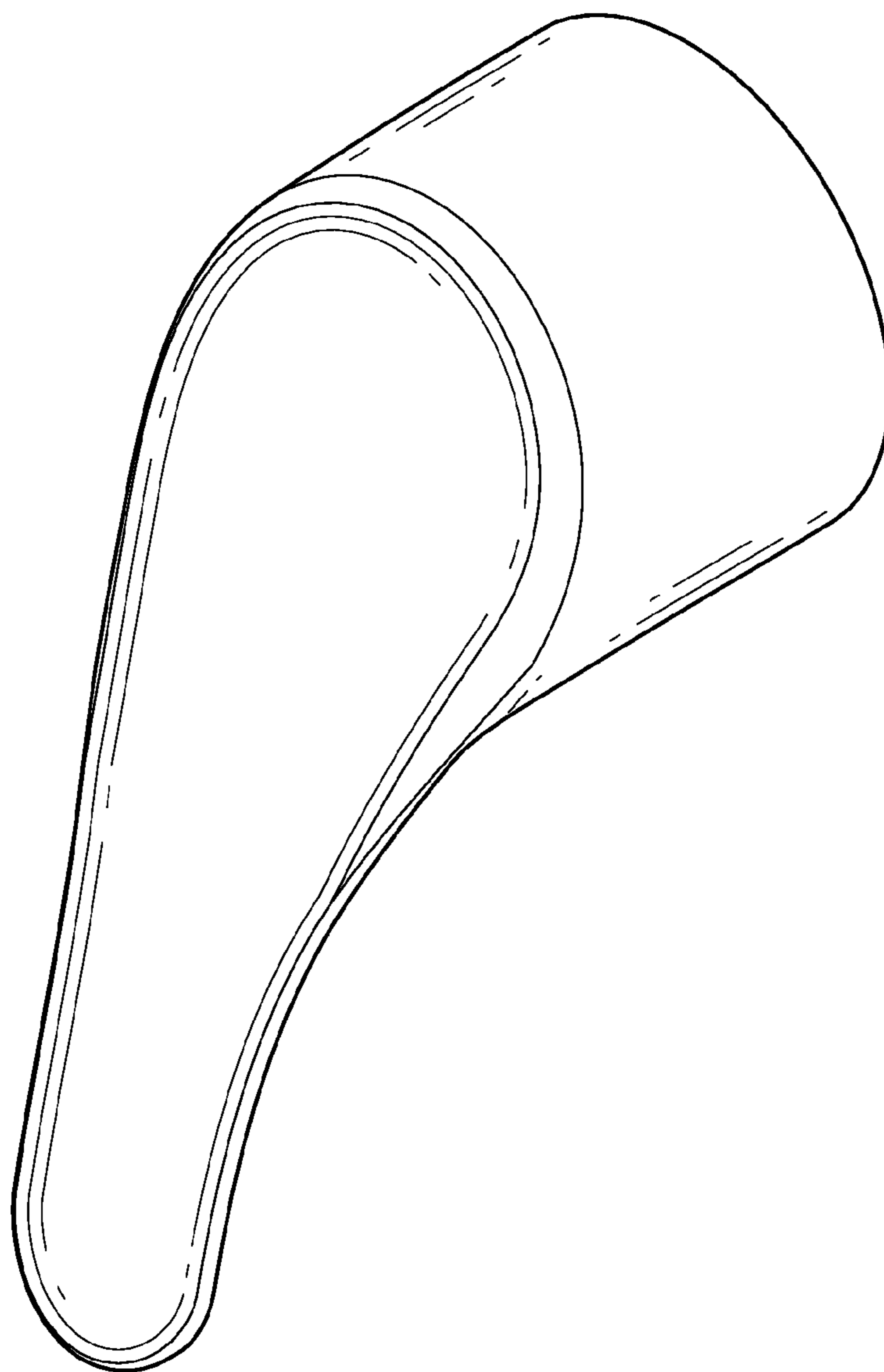

FIG. 1

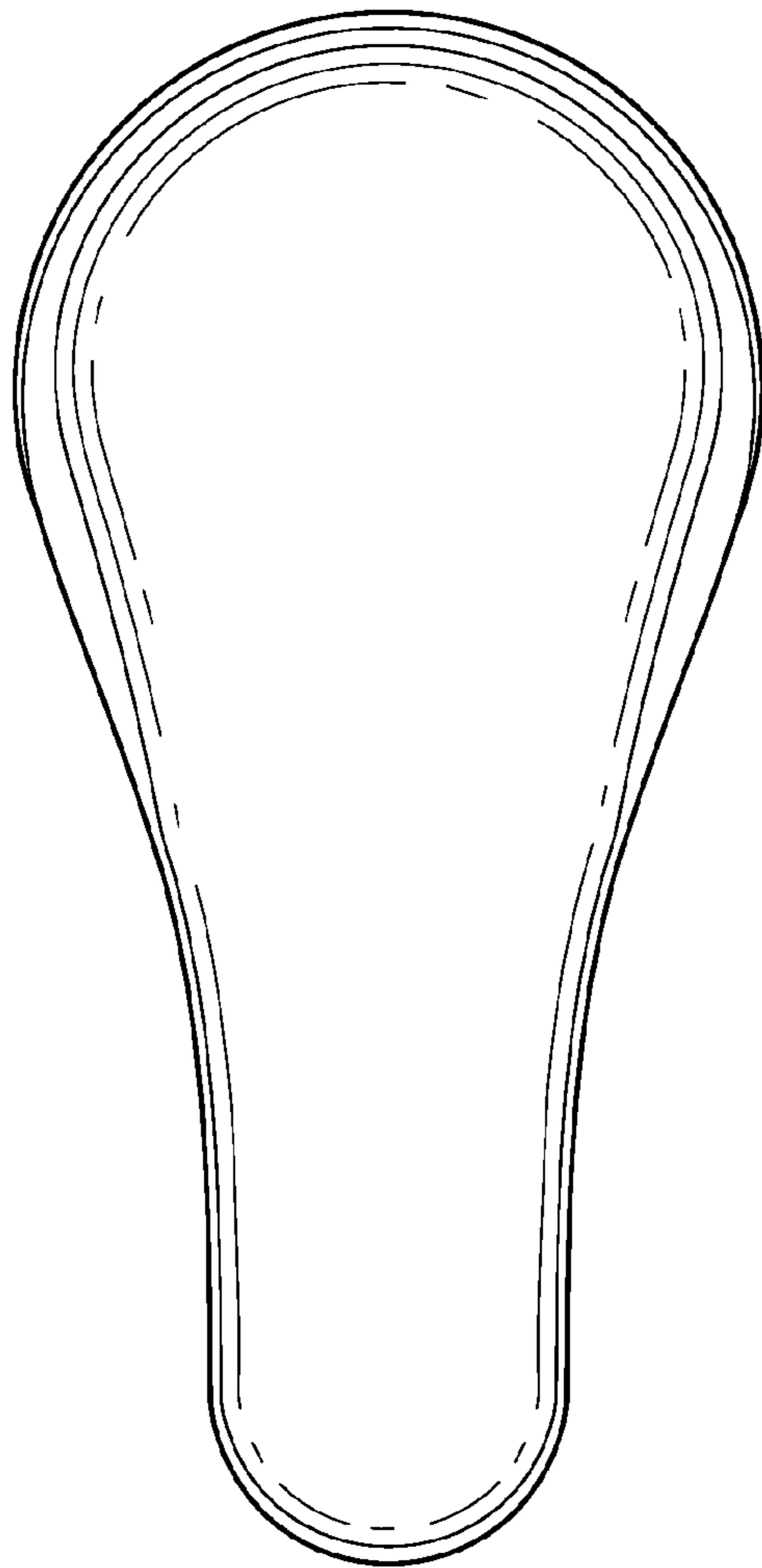

FIG. 2

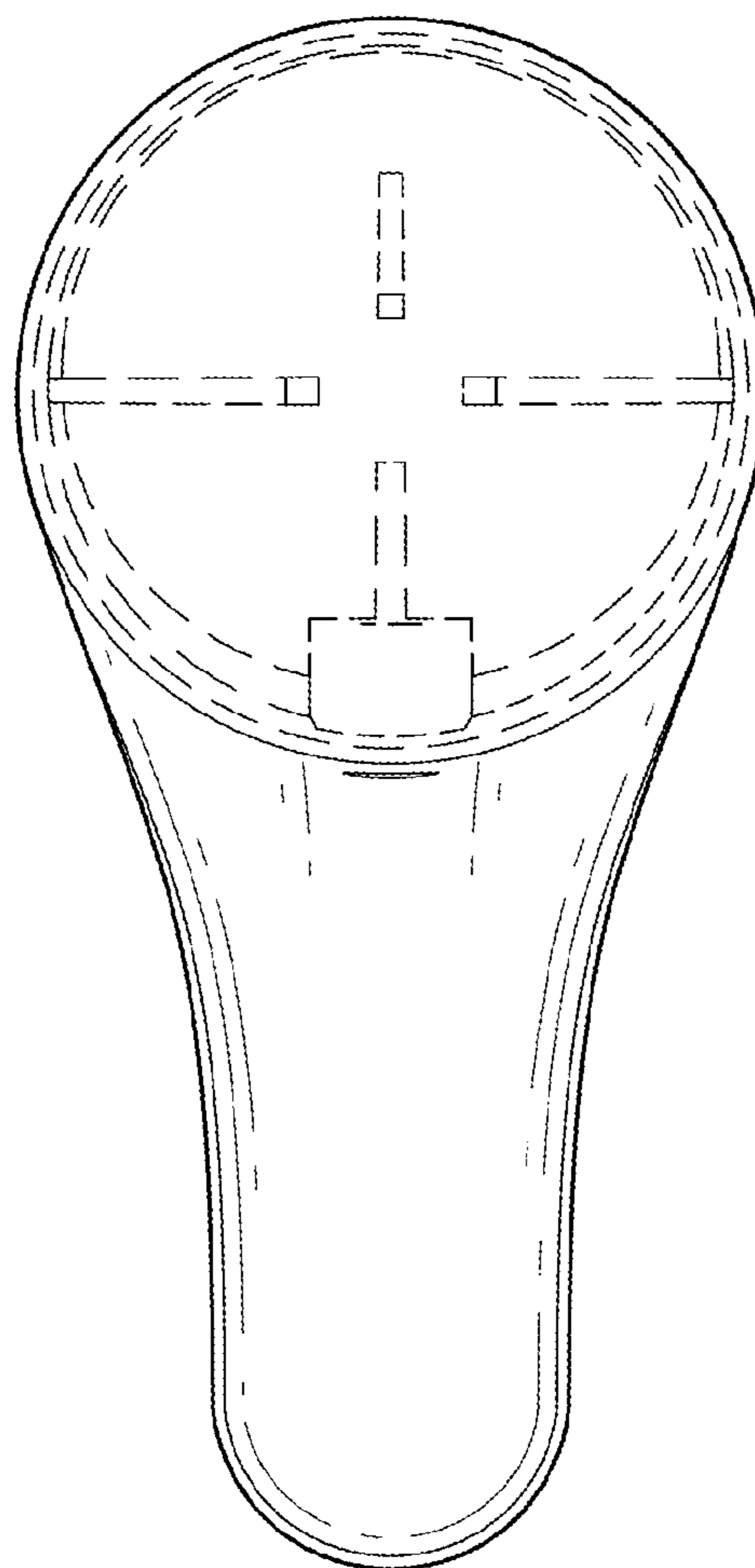

FIG. 3

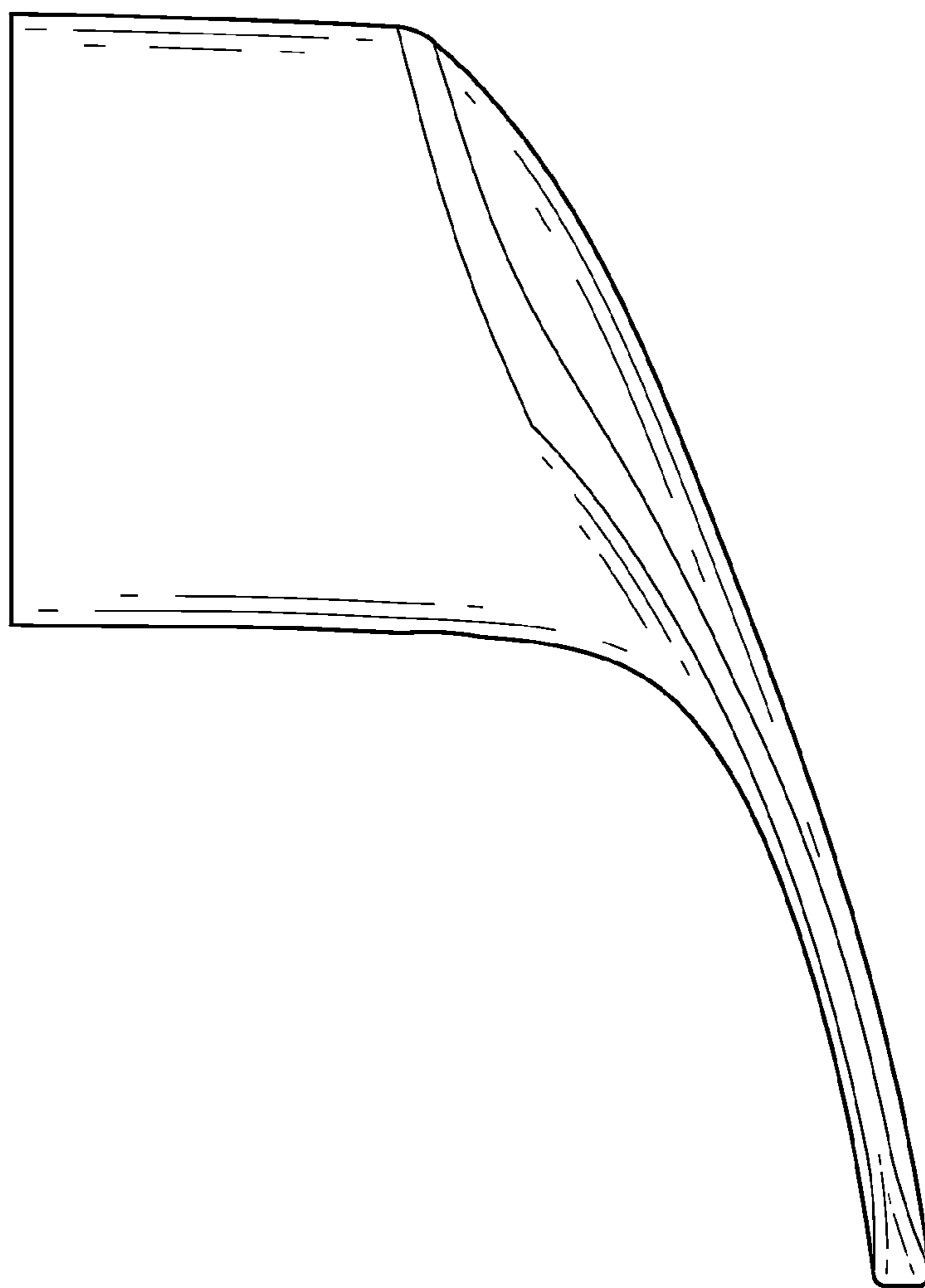

FIG. 4

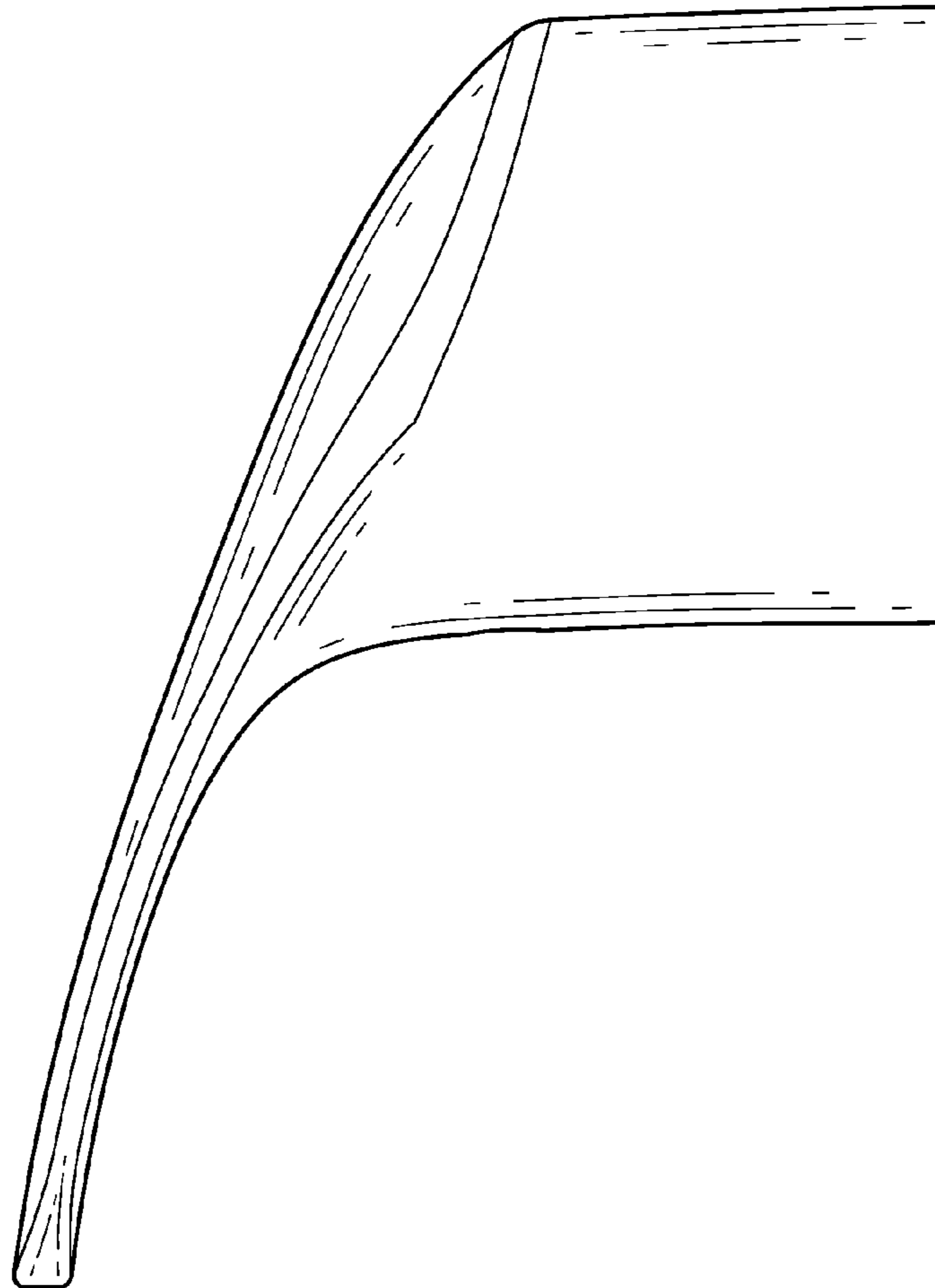

FIG. 5

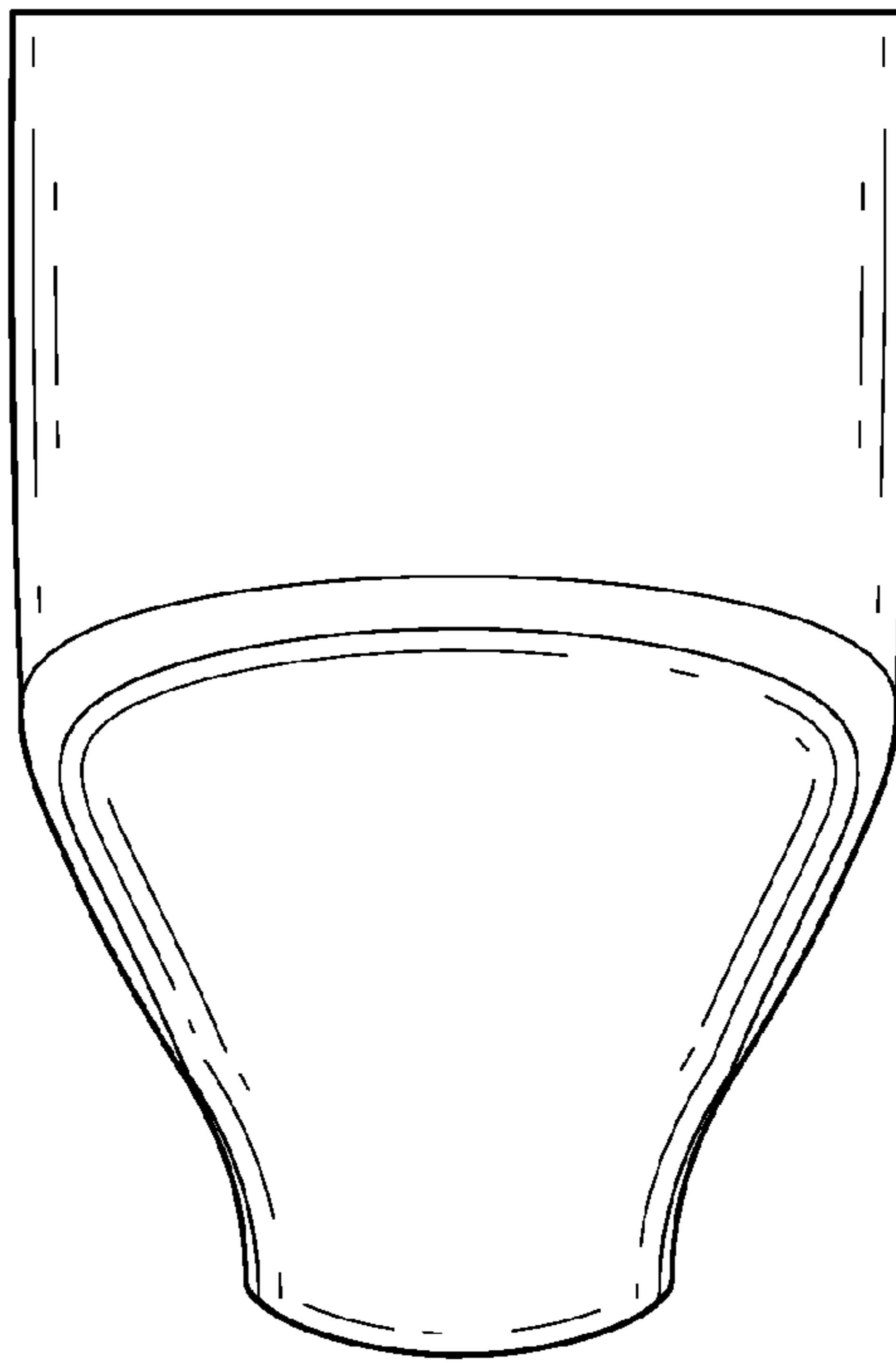

FIG. 6

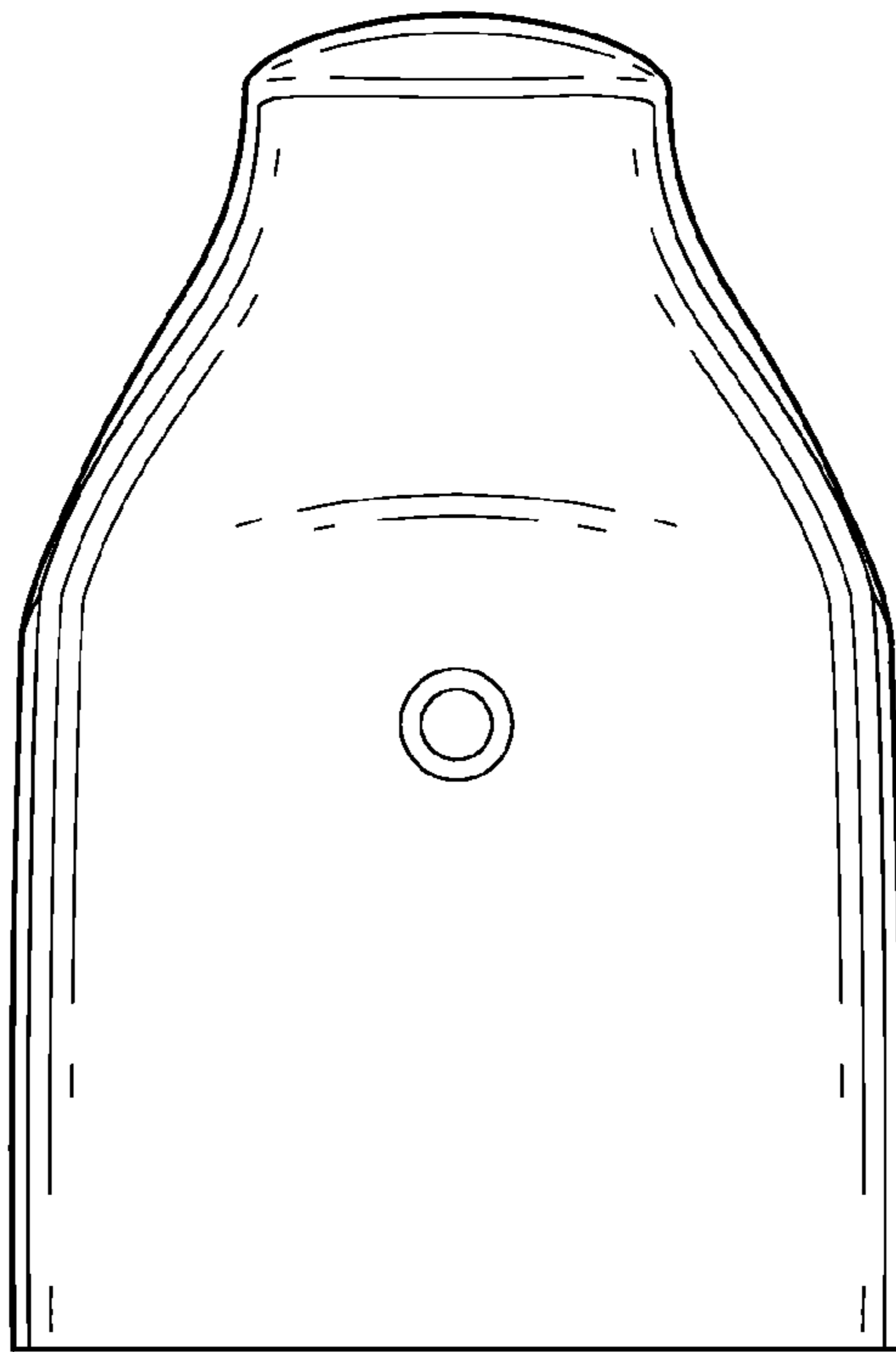

FIG. 7



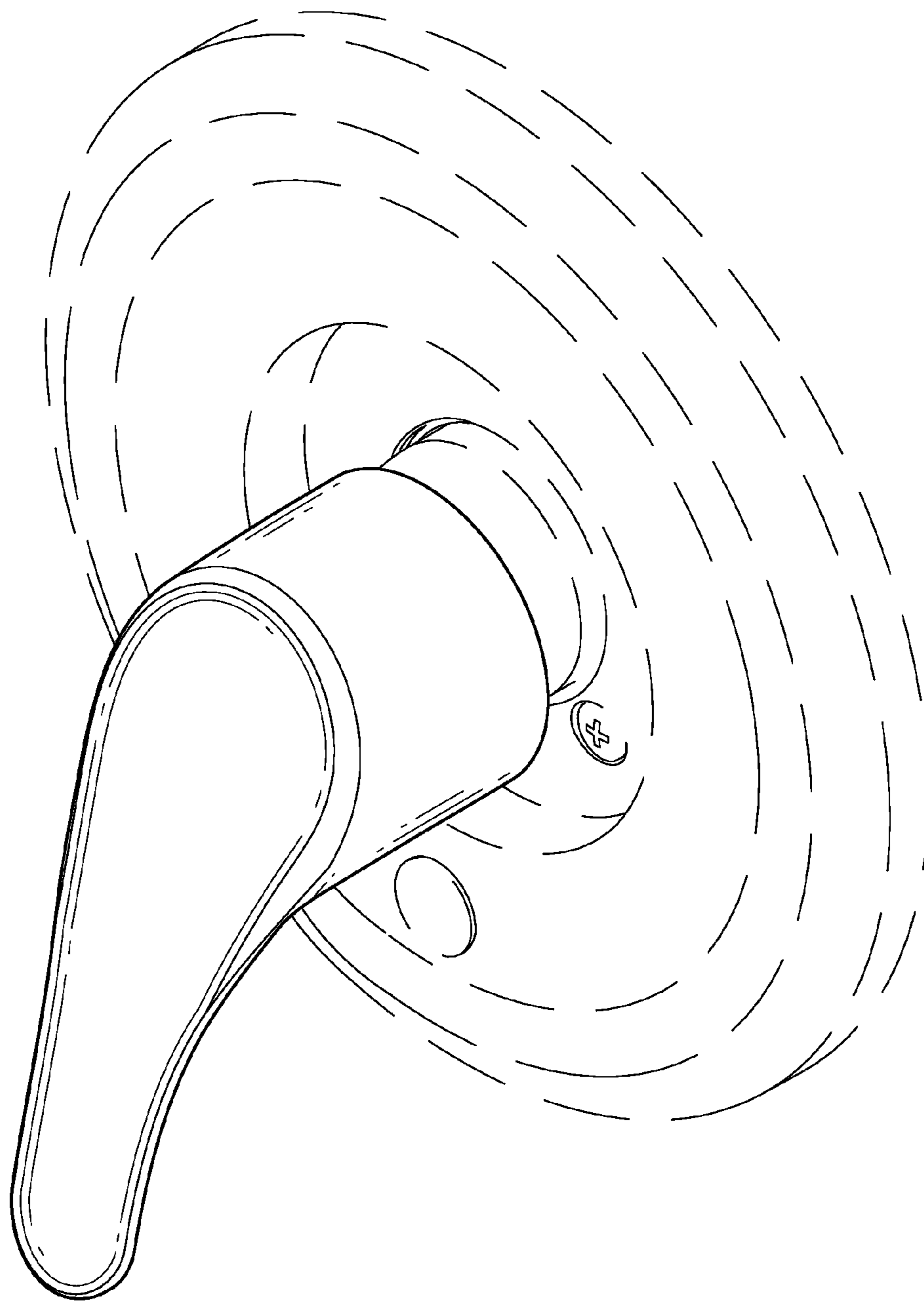

FIG. 8