



US00D671190S

(12) **United States Design Patent**  
**Sheridan**

(10) **Patent No.:** **US D671,190 S**  
(45) **Date of Patent:** **\*\* Nov. 20, 2012**

(54) **LANDSCAPE WATERFALL**

(74) *Attorney, Agent, or Firm* — Patterson & Sheridan, LLP

(76) **Inventor:** **Richard Sheridan**, Neptune, NJ (US)

(57) **CLAIM**  
The ornamental design for a landscape waterfall, as shown and described.

(\*\*) **Term:** **14 Years**

**DESCRIPTION**

(21) **Appl. No.:** **29/412,844**

FIG. 1 is a perspective view of a landscape waterfall illustrating water (shown in phantom) exiting an aperture and falling into a splash reducing material (also shown in phantom), the phantom lines forming no part of the claimed design.

(22) **Filed:** **Feb. 8, 2012**

FIG. 2 is a front side view of the landscape waterfall of FIG. 1.

(51) **LOC (9) Cl.** ..... **23-01**

FIG. 3 is a back side view of the landscape waterfall of FIG. 1, and ductwork shown in phantom on the back side view forms no part of the claimed design.

(52) **U.S. Cl.** ..... **D23/201**

(58) **Field of Classification Search** ..... D23/201;  
D11/131, 139; 239/17-21

FIG. 4 is a left side view of the landscape waterfall of FIG. 1, and ductwork shown in phantom on the left side view forms no part of the claimed design.

See application file for complete search history.

FIG. 5 is a right side view of the landscape waterfall of FIG. 1, and ductwork shown in phantom on the right side view forms no part of the claimed design.

(56) **References Cited**

**U.S. PATENT DOCUMENTS**

5,226,935	A *	7/1993	Wolff et al.	96/262
D470,215	S *	2/2003	Lussier	D23/201
D491,250	S *	6/2004	Raymond et al.	D23/201
D598,973	S *	8/2009	Muhlethaler	D23/201
D643,505	S *	8/2011	Haijin	D23/201

\* cited by examiner

FIG. 6 is a top side view of the landscape waterfall of FIG. 1; and,

FIG. 7 is a bottom side view of the landscape waterfall of FIG. 1, and ductwork shown in phantom on the bottom side view forms no part of the claimed design.

The broken and phantom lines in the figures form no part of the claimed design.

*Primary Examiner* — Robin V Webster

**1 Claim, 5 Drawing Sheets**

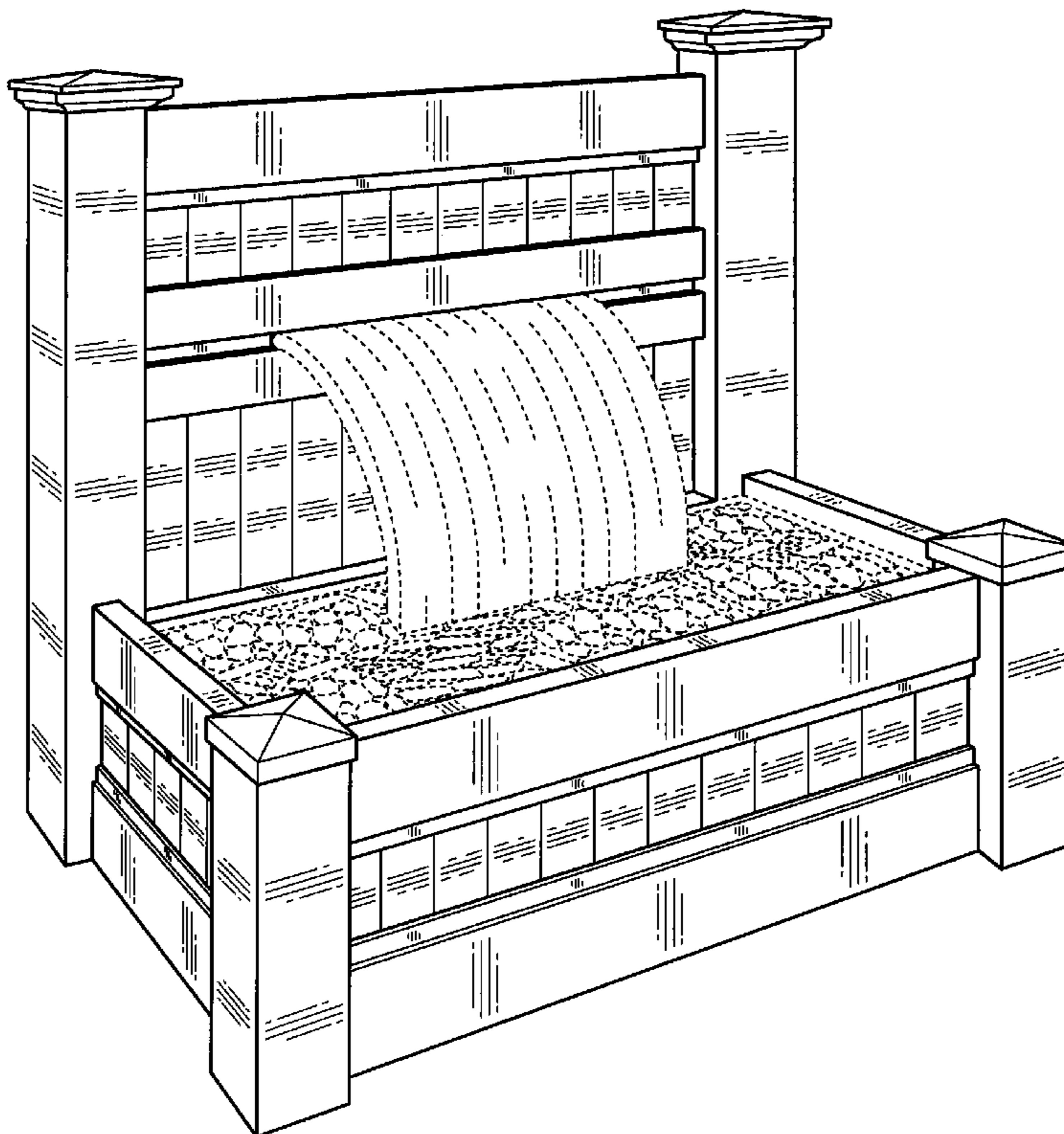

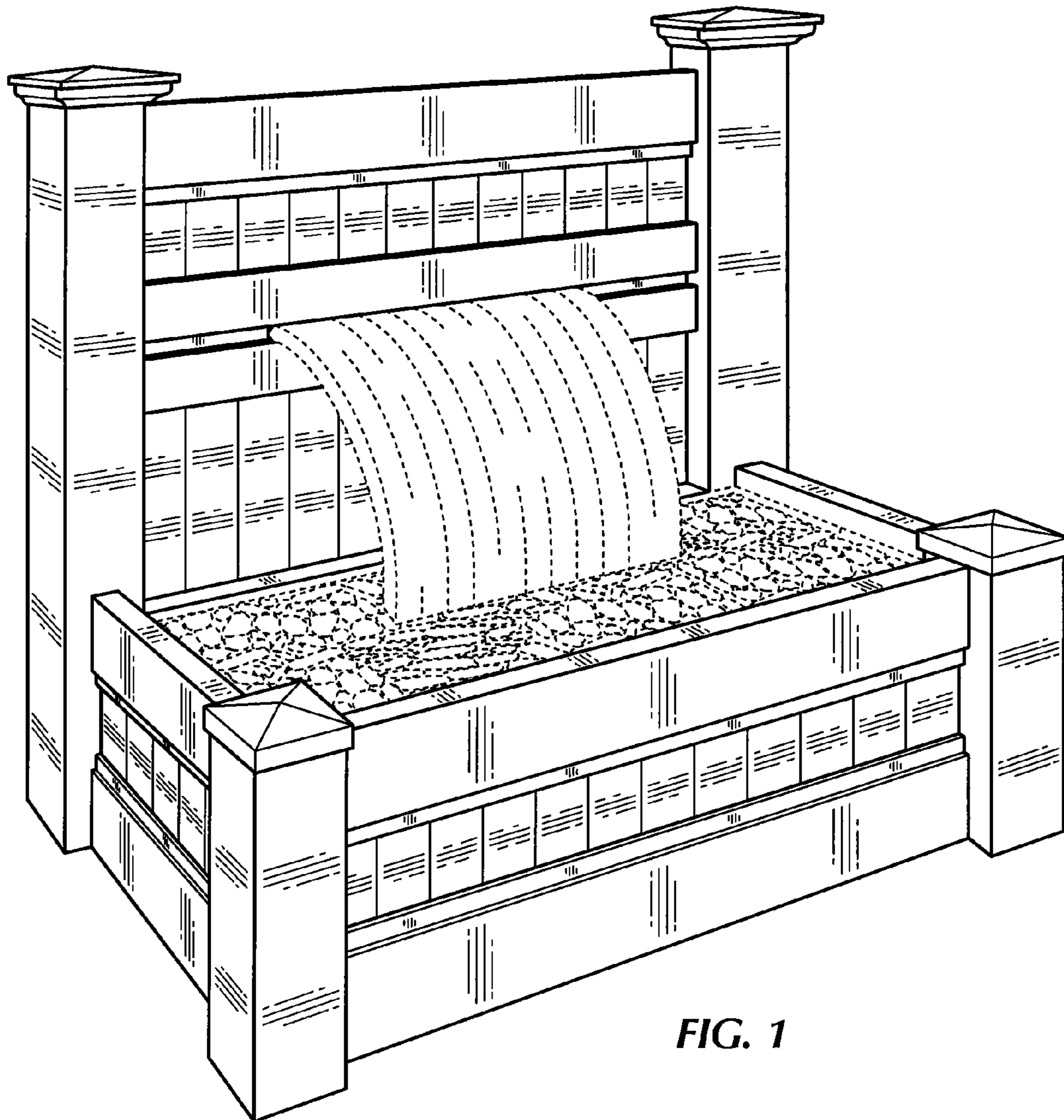

*FIG. 1*

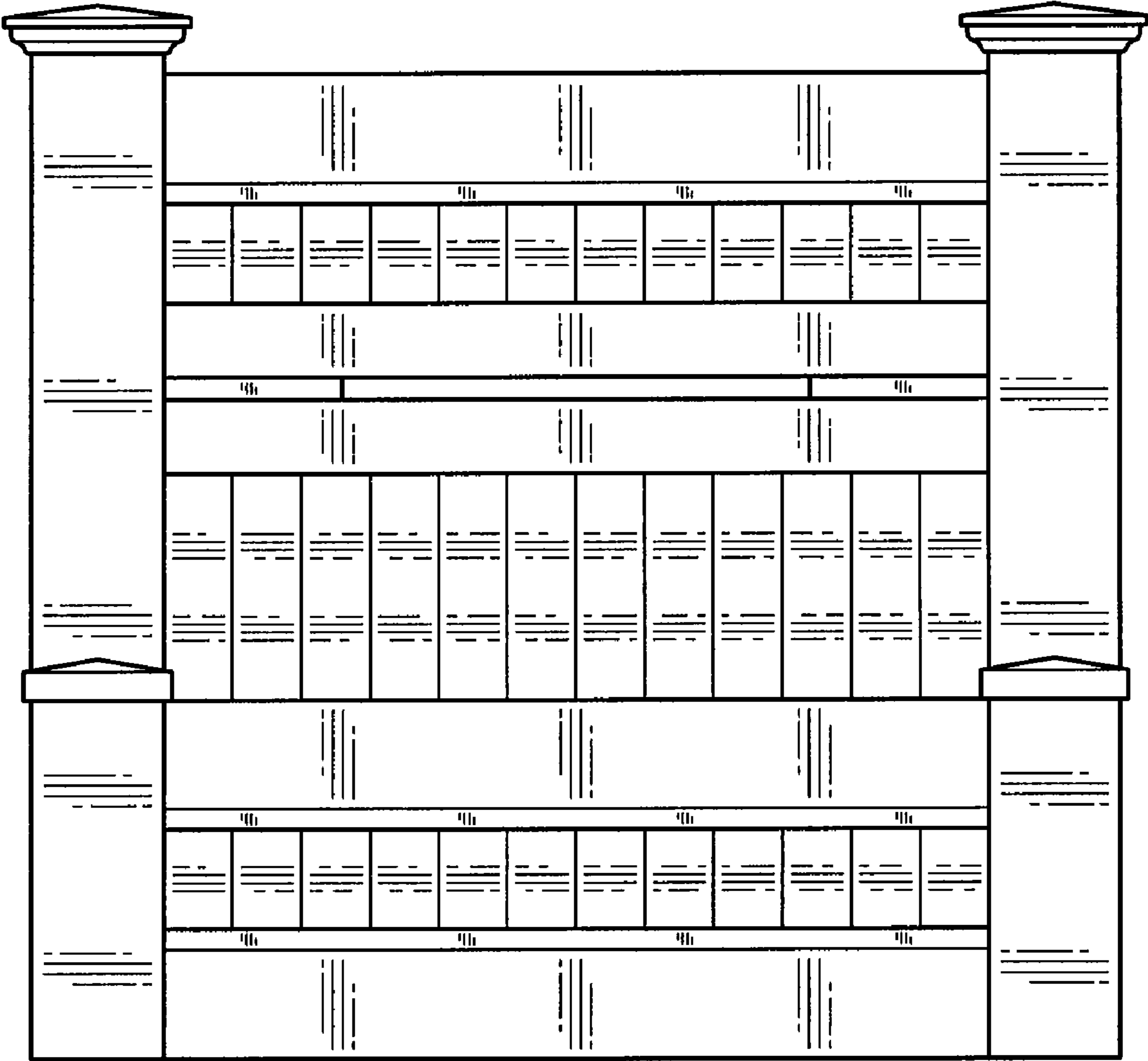

FIG. 2

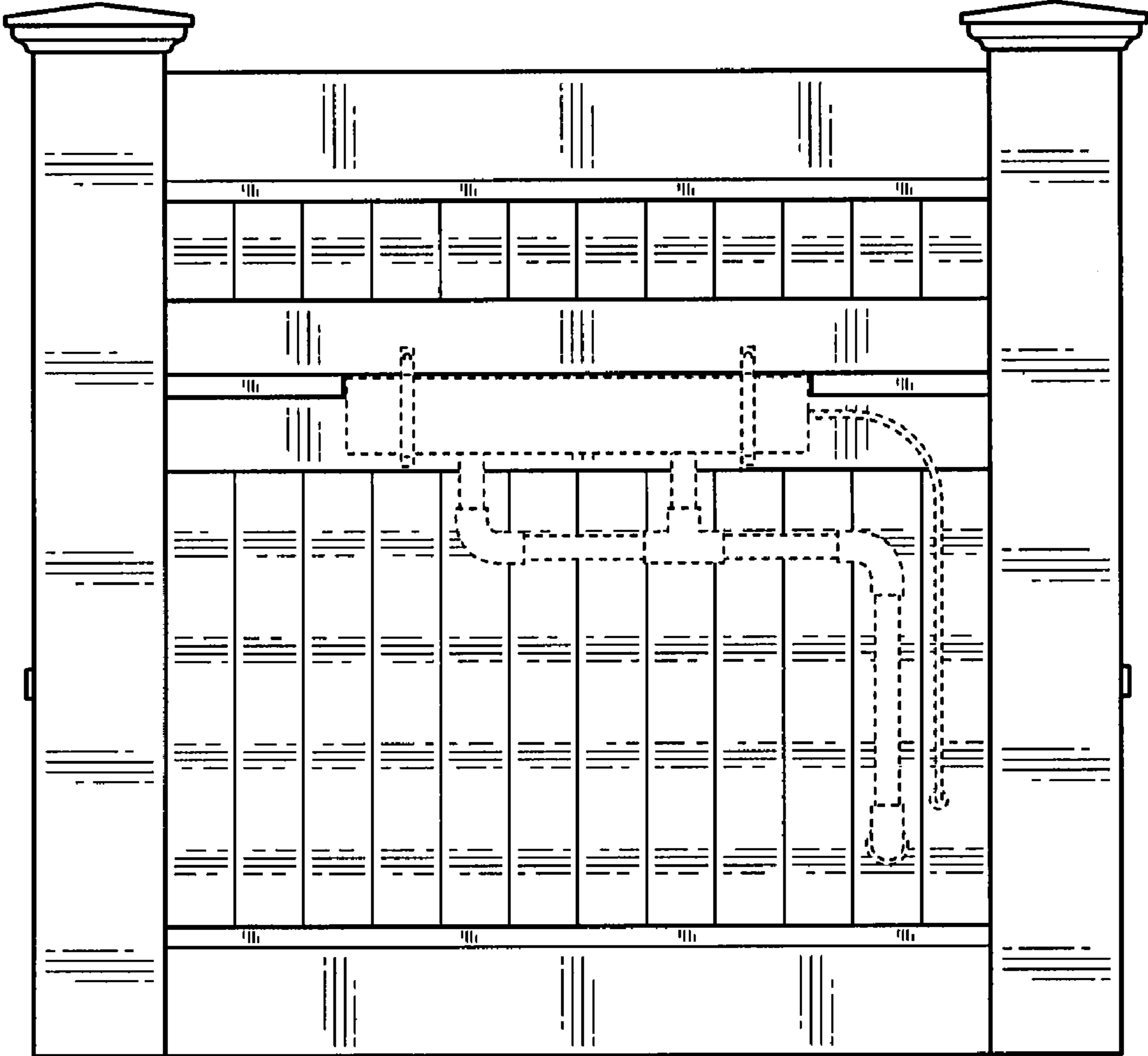
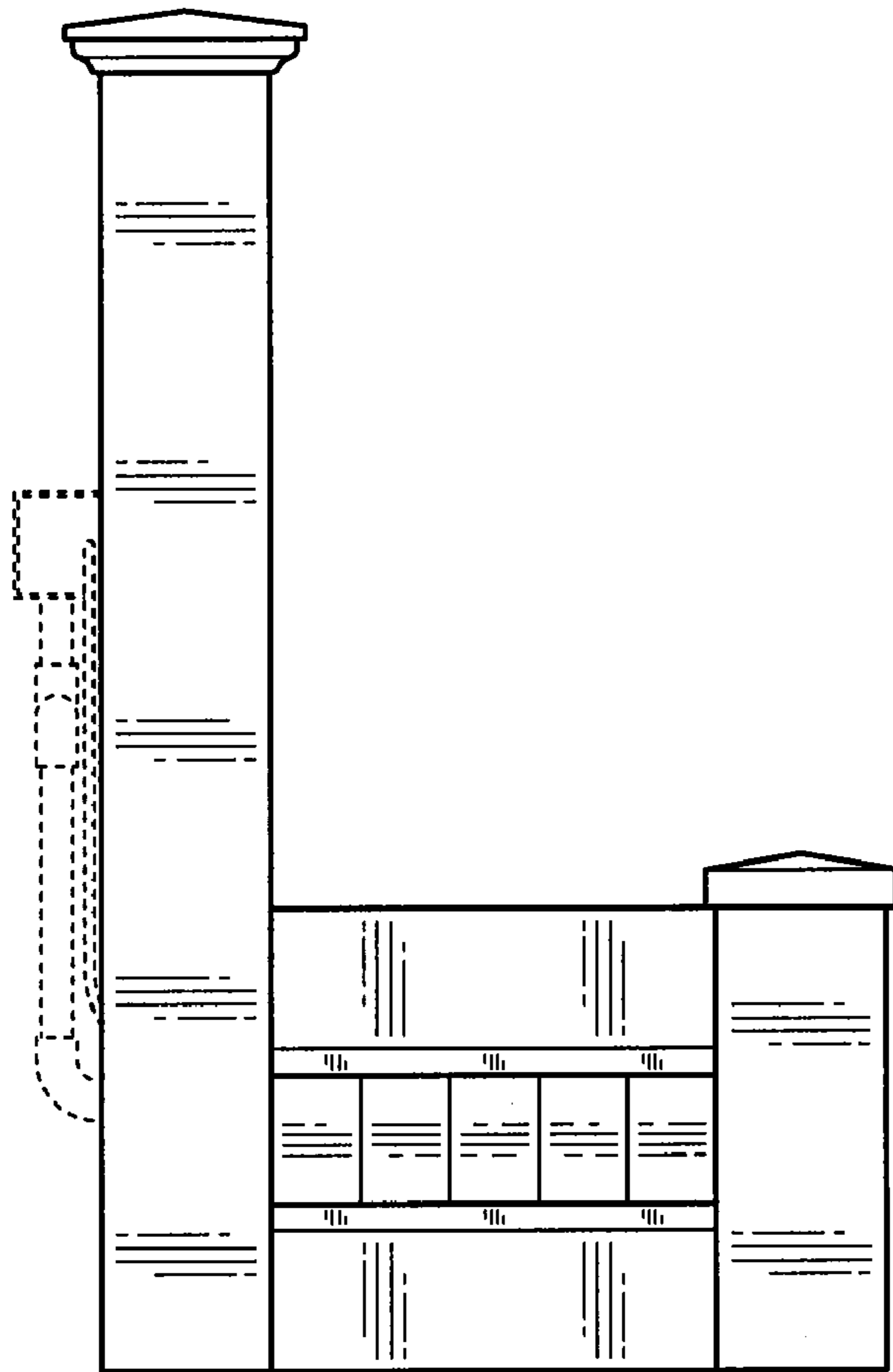
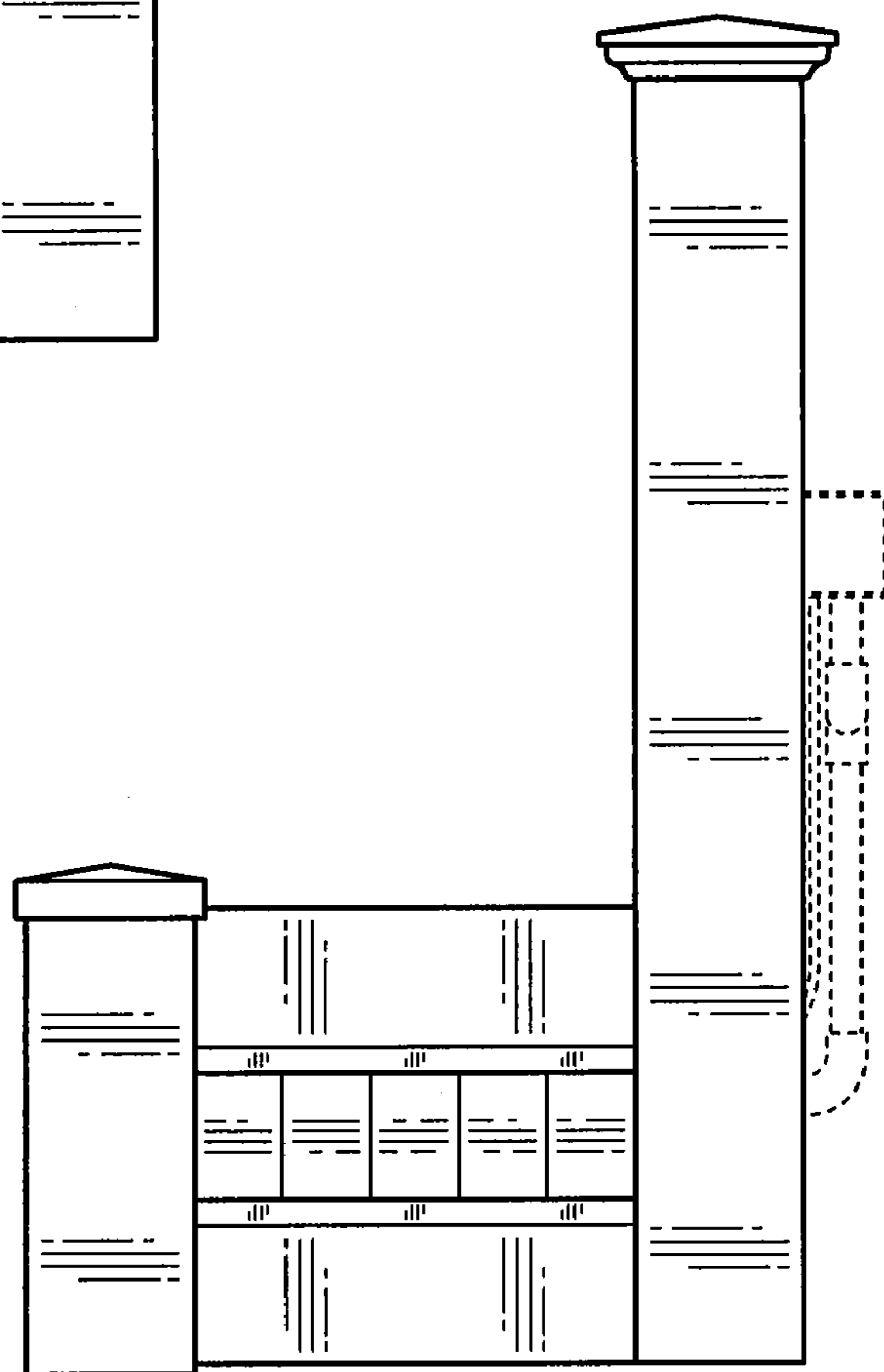

FIG. 3



**FIG. 4**



**FIG. 5**

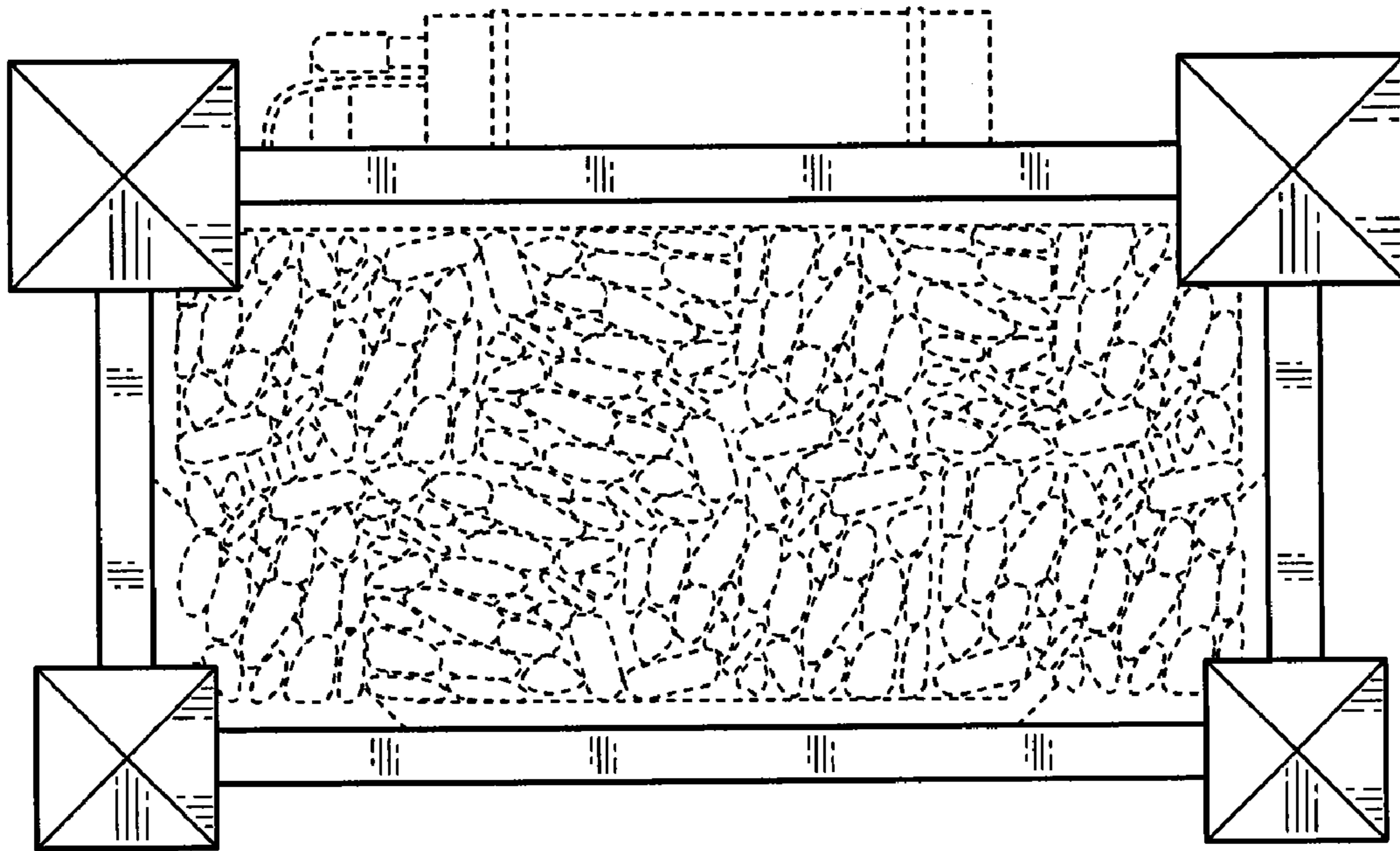

FIG. 6

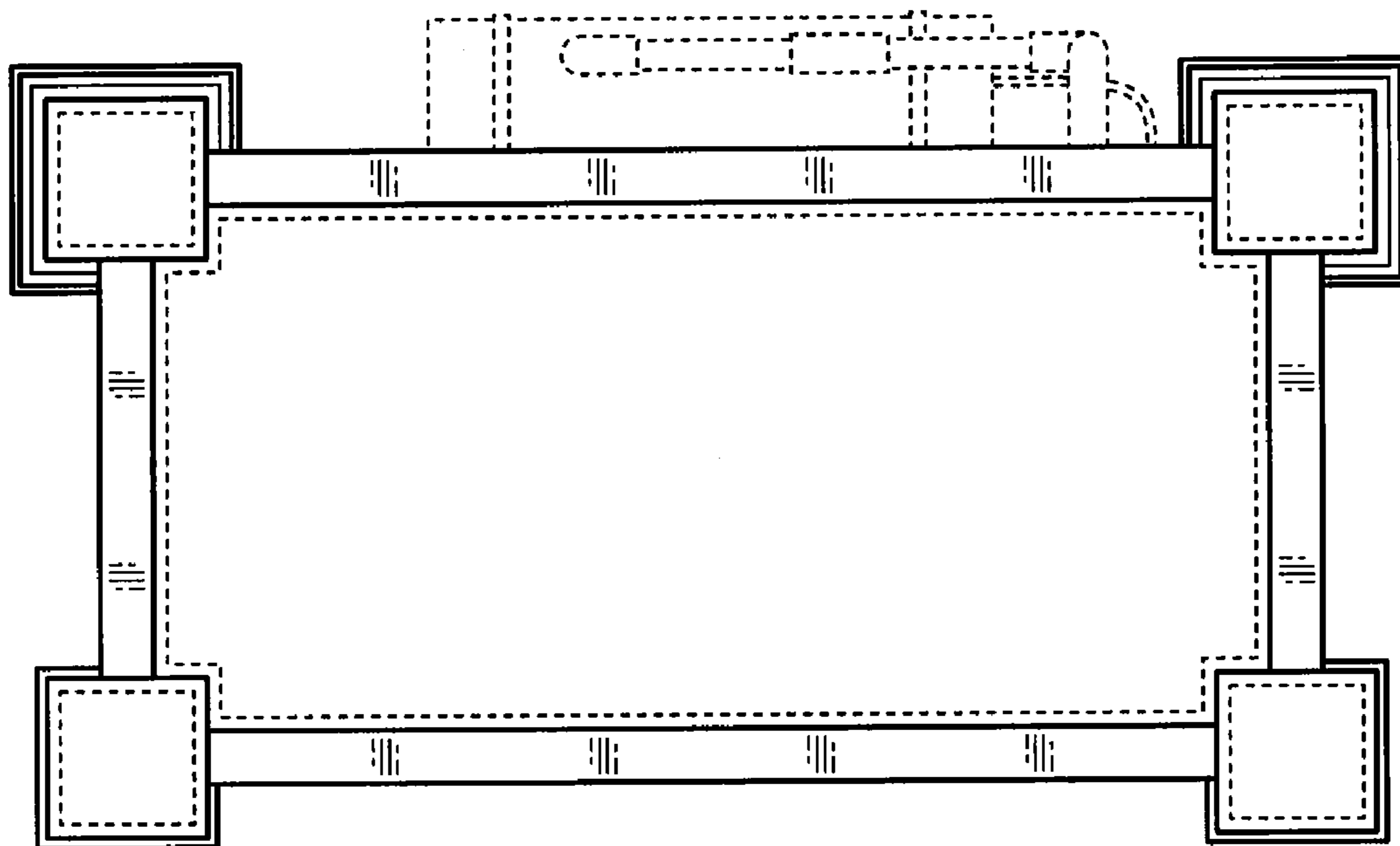

FIG. 7