



US00D671187S

(12) **United States Design Patent**
Saringer

(10) **Patent No.:** **US D671,187 S**

(45) **Date of Patent:** **** Nov. 20, 2012**

(54) **DECOY STAND**

(75) Inventor: **Donald J. Saringer**, Neenah, WI (US)

(73) Assignee: **Mallard Motels, LLC**, Appleton, WI (US)

(**) Term: **14 Years**

(21) Appl. No.: **29/410,210**

(22) Filed: **Jan. 5, 2012**

(51) **LOC (9) Cl.** **22-05**

(52) **U.S. Cl.** **D22/125**

(58) **Field of Classification Search** D22/125,
D22/199; 43/1-3; 248/156, 175, 215, 530,
248/545; 47/42, 44, 47
See application file for complete search history.

6,938,370 B2 * 9/2005 Johns 47/42
6,948,694 B1 * 9/2005 Gilbert 248/530
7,458,475 B2 12/2008 Ho
2003/0024146 A1 2/2003 Spady et al.
2003/0173474 A1 9/2003 Taylor

OTHER PUBLICATIONS

Great Day Hot Wings Duck Decoy Tree, printed from web-site <http://www.mackspw.com>, Jul. 22, 2011, 2 pages.
Cabela'S Waterfowl Catalog, 2010, pp. 38-41.

* cited by examiner

Primary Examiner — Catheri Oliver-Garcia

(74) *Attorney, Agent, or Firm* — Michael Best & Friedrich LLP

(57) **CLAIM**

I claim the ornamental design for a decoy stand, as shown and described.

DESCRIPTION

FIG. 1 is a front perspective view of a decoy stand of the present invention.

FIG. 2 is an enlarged view of a portion of the decoy stand of FIG. 1.

FIG. 3 is a front view of the decoy stand of FIG. 1.

FIG. 4 is a rear view of the decoy stand of FIG. 1.

FIG. 5 is a right-side view of the decoy stand of FIG. 1.

FIG. 6 is a left-side view of the decoy stand of FIG. 1.

FIG. 7 is a top view of the decoy stand of FIG. 1; and,

FIG. 8 is a bottom view of the decoy stand of FIG. 1.

The portions of the decoy stand shown in broken lines are included for the purpose of illustrating environment and form no part of the claimed design.

1 Claim, 8 Drawing Sheets

(56) **References Cited**

U.S. PATENT DOCUMENTS

983,589	A	2/1911	Wendt	
1,073,763	A	9/1913	Kalitzky	
1,107,075	A	8/1914	Karges	
1,266,749	A	5/1918	Abbott	
1,590,637	A	6/1926	Marengo	
2,246,574	A	6/1941	Coe	
2,547,286	A	4/1951	Sabin	
2,616,200	A	11/1952	Milam	
2,624,144	A	1/1953	Beverman	
2,952,090	A *	9/1960	Pittenger	43/3
3,768,192	A	10/1973	Caccamo	
4,660,313	A *	4/1987	Bauernfeind et al.	43/3
5,074,071	A	12/1991	Dunne	
6,234,444	B1	5/2001	Haddad	
6,595,377	B1	7/2003	Hetu	
6,655,071	B2 *	12/2003	Barnes et al.	43/3

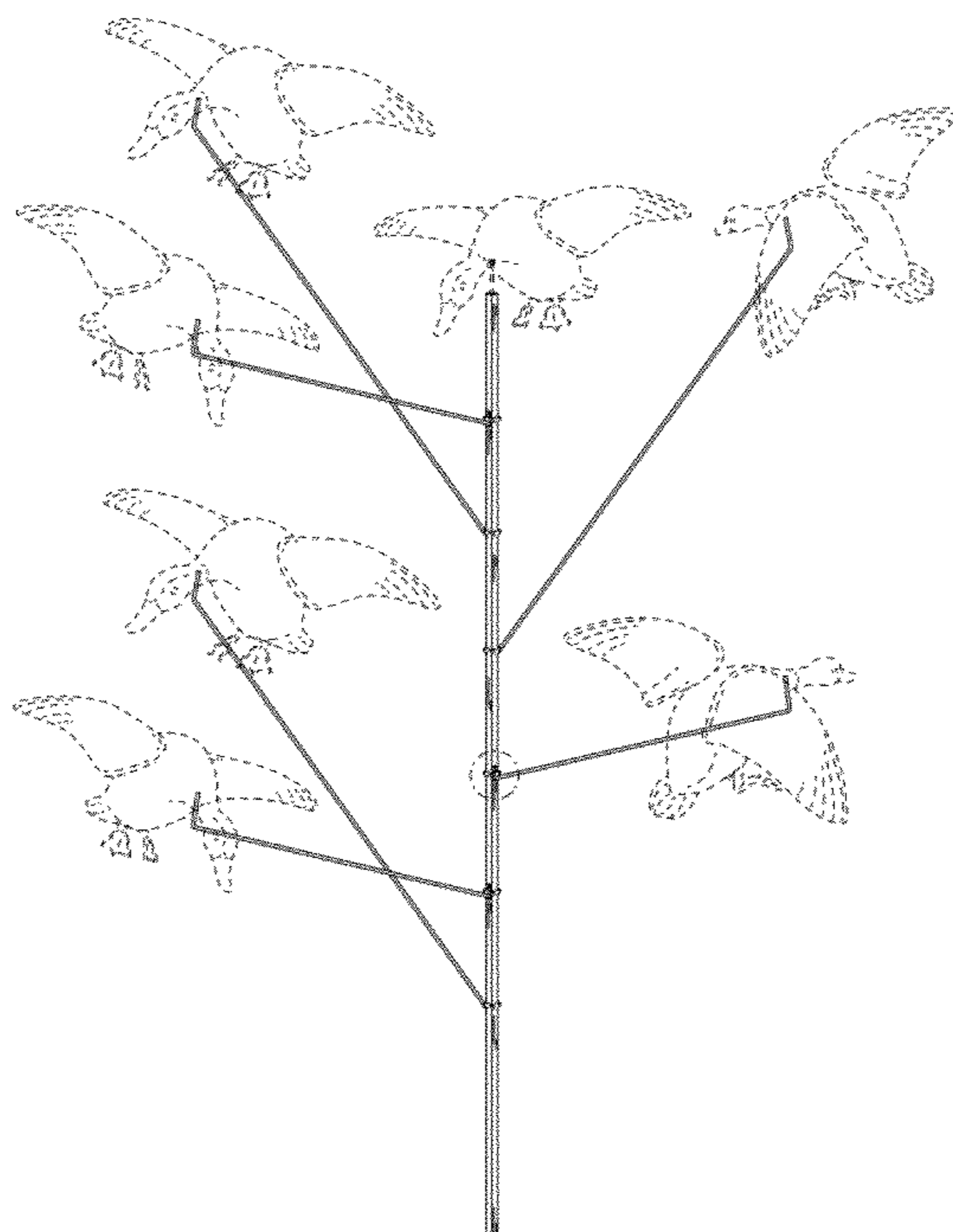

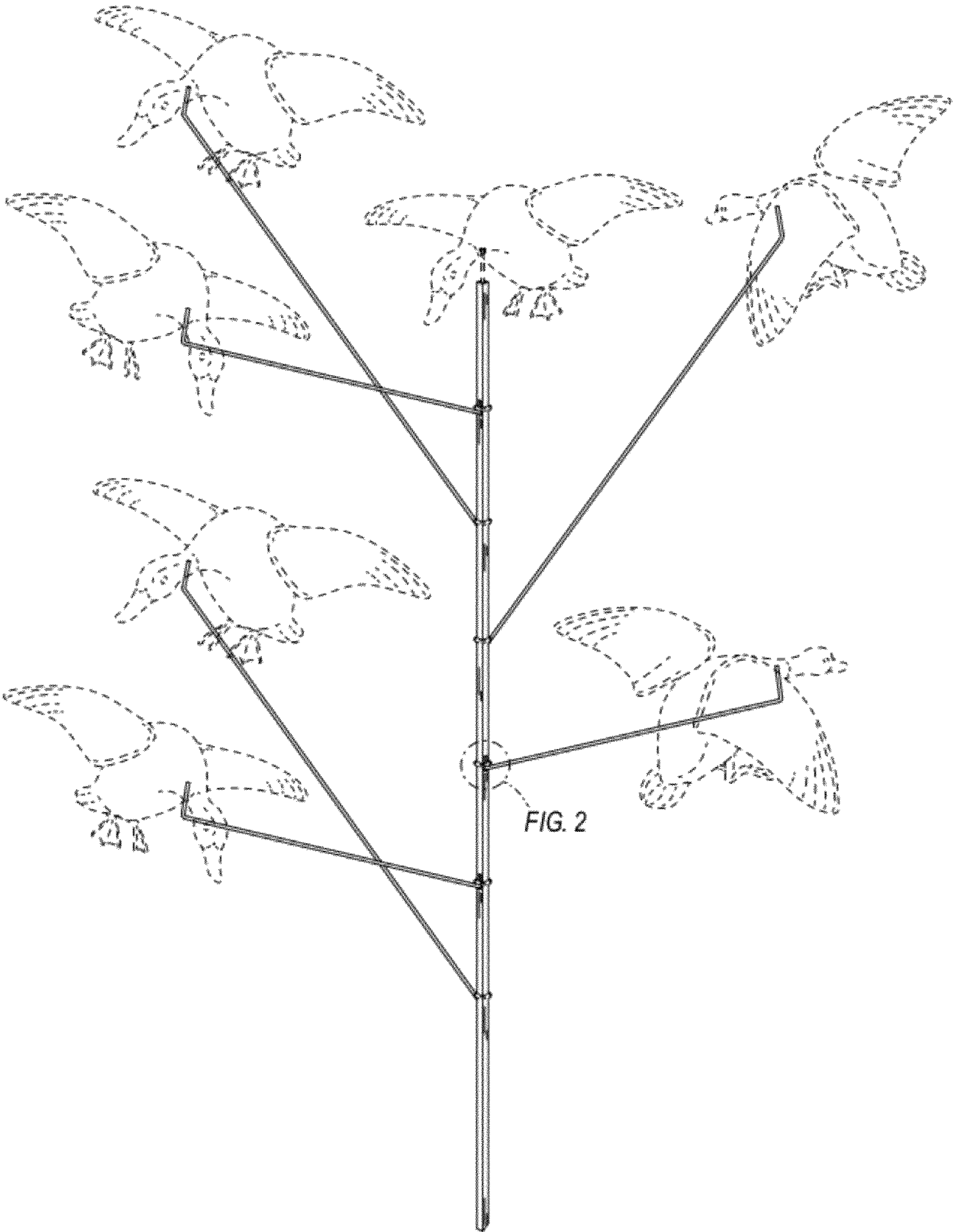

FIG. 1

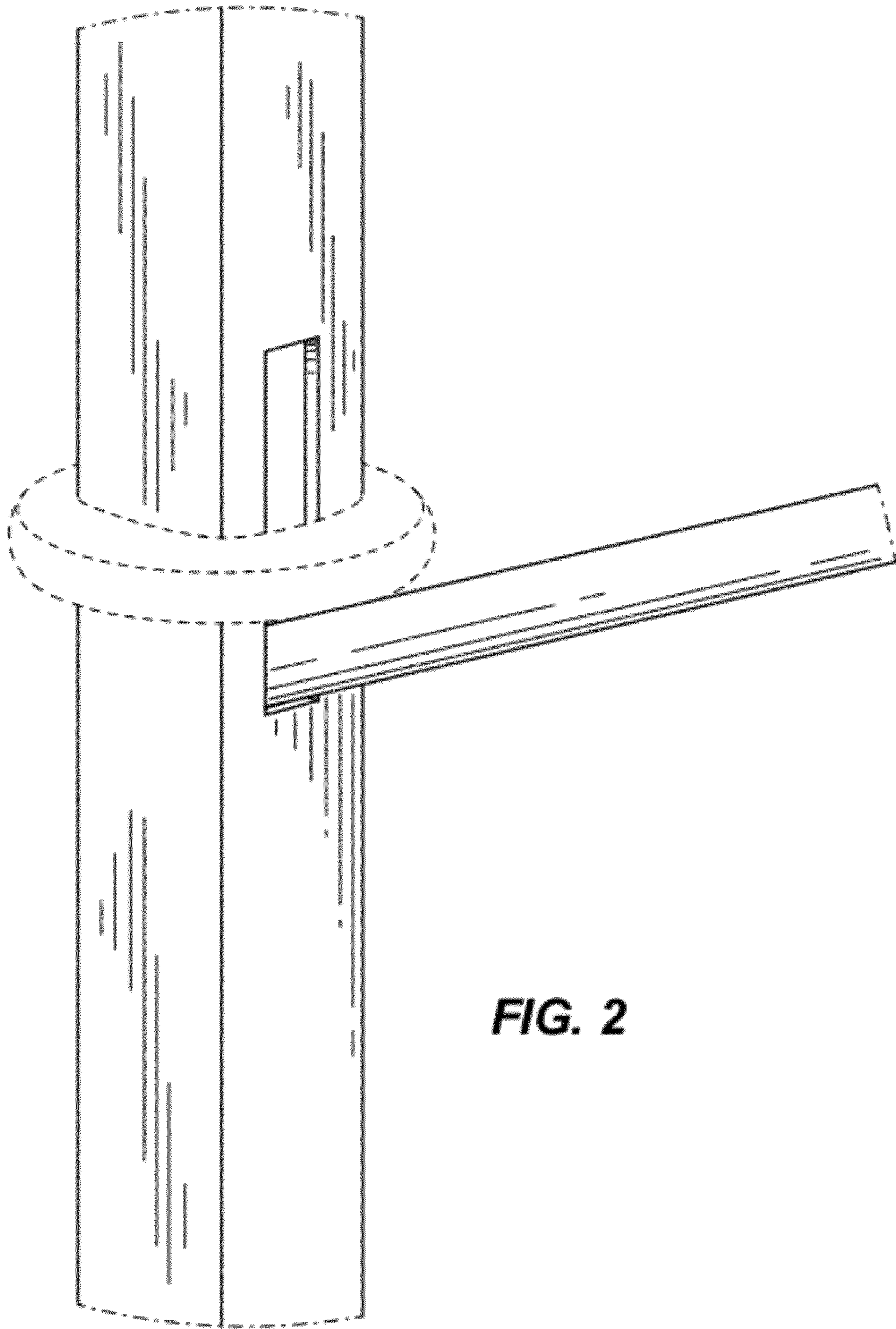

FIG. 2

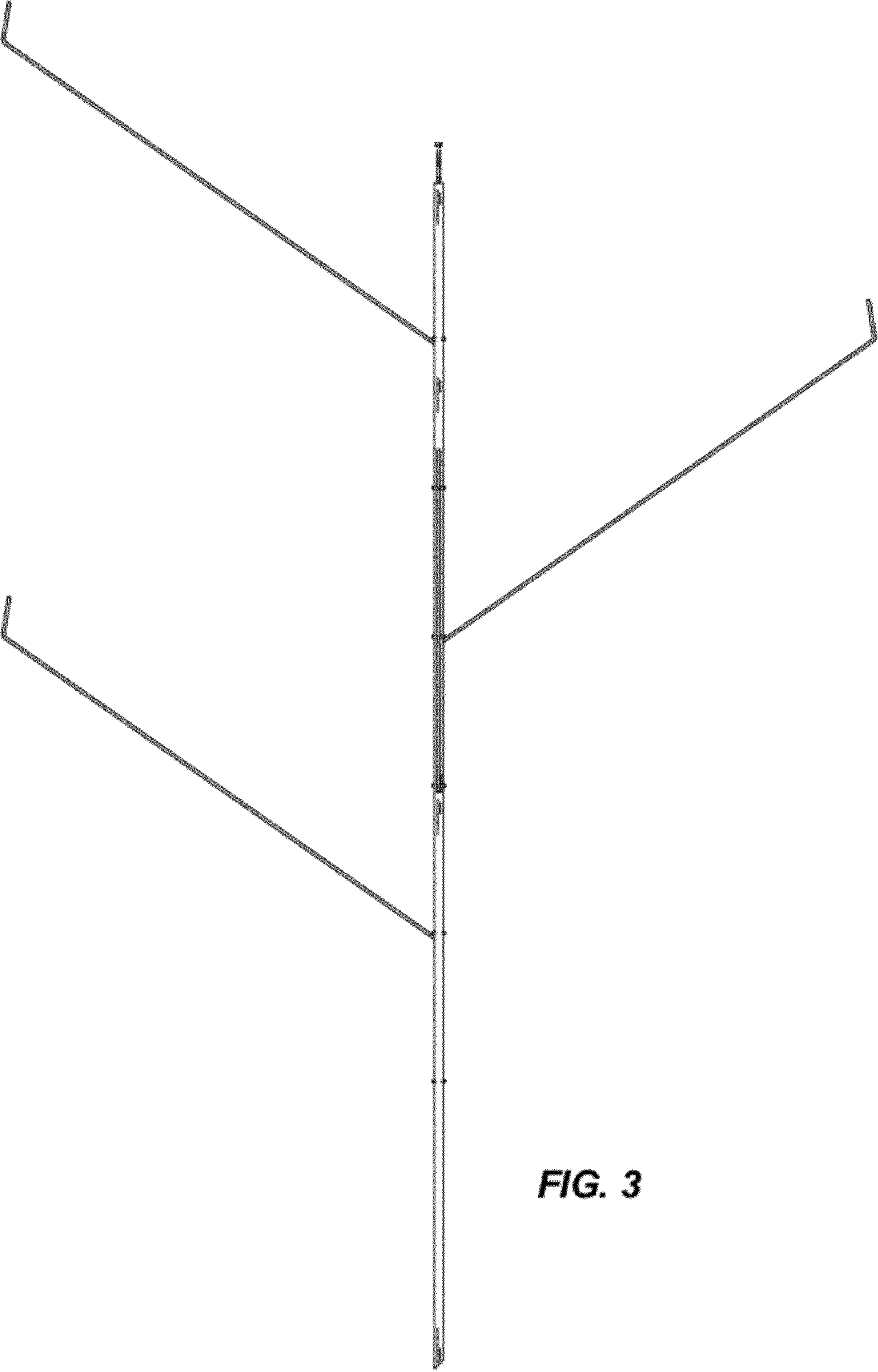

FIG. 3

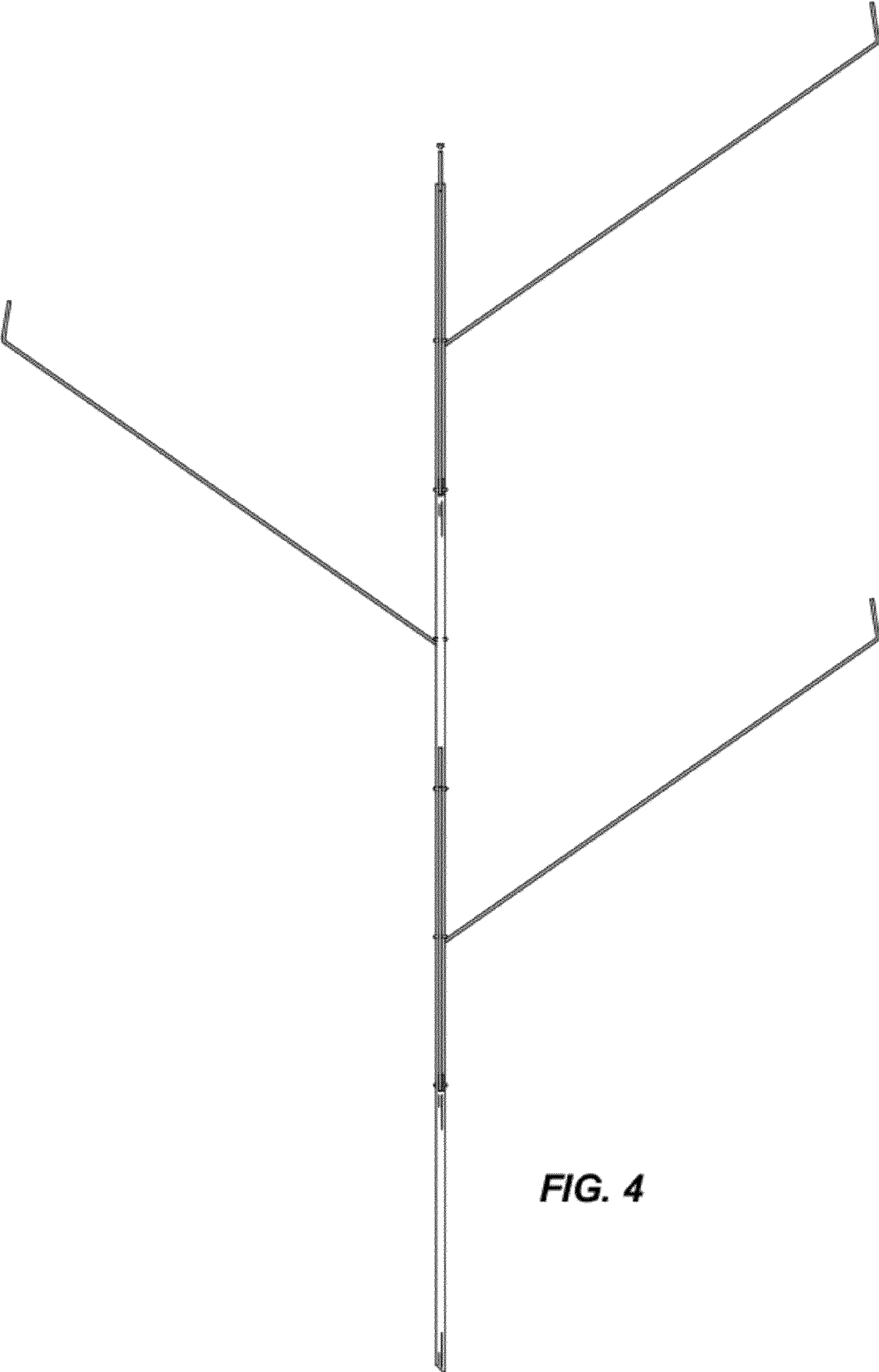

FIG. 4

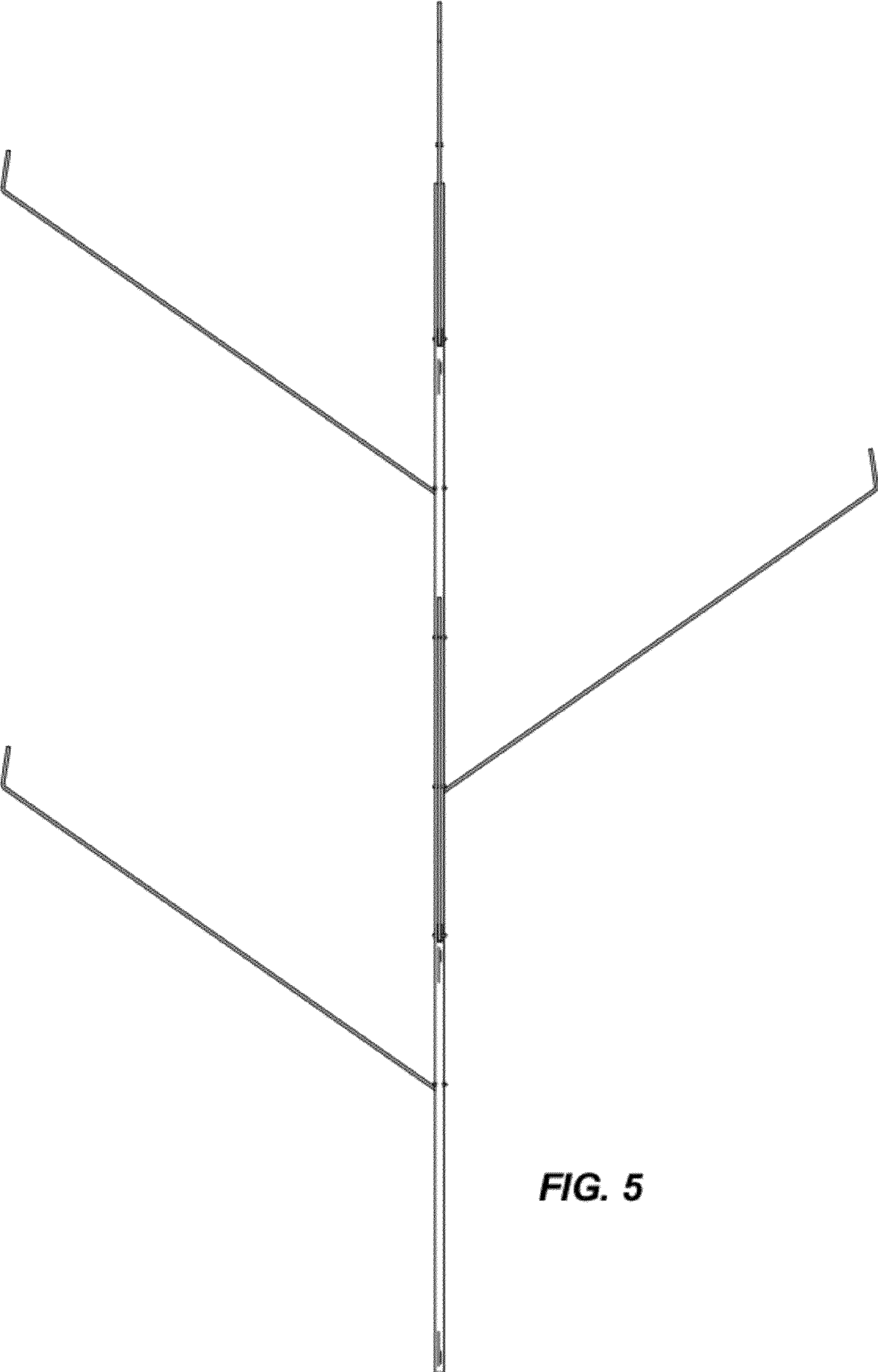

FIG. 5

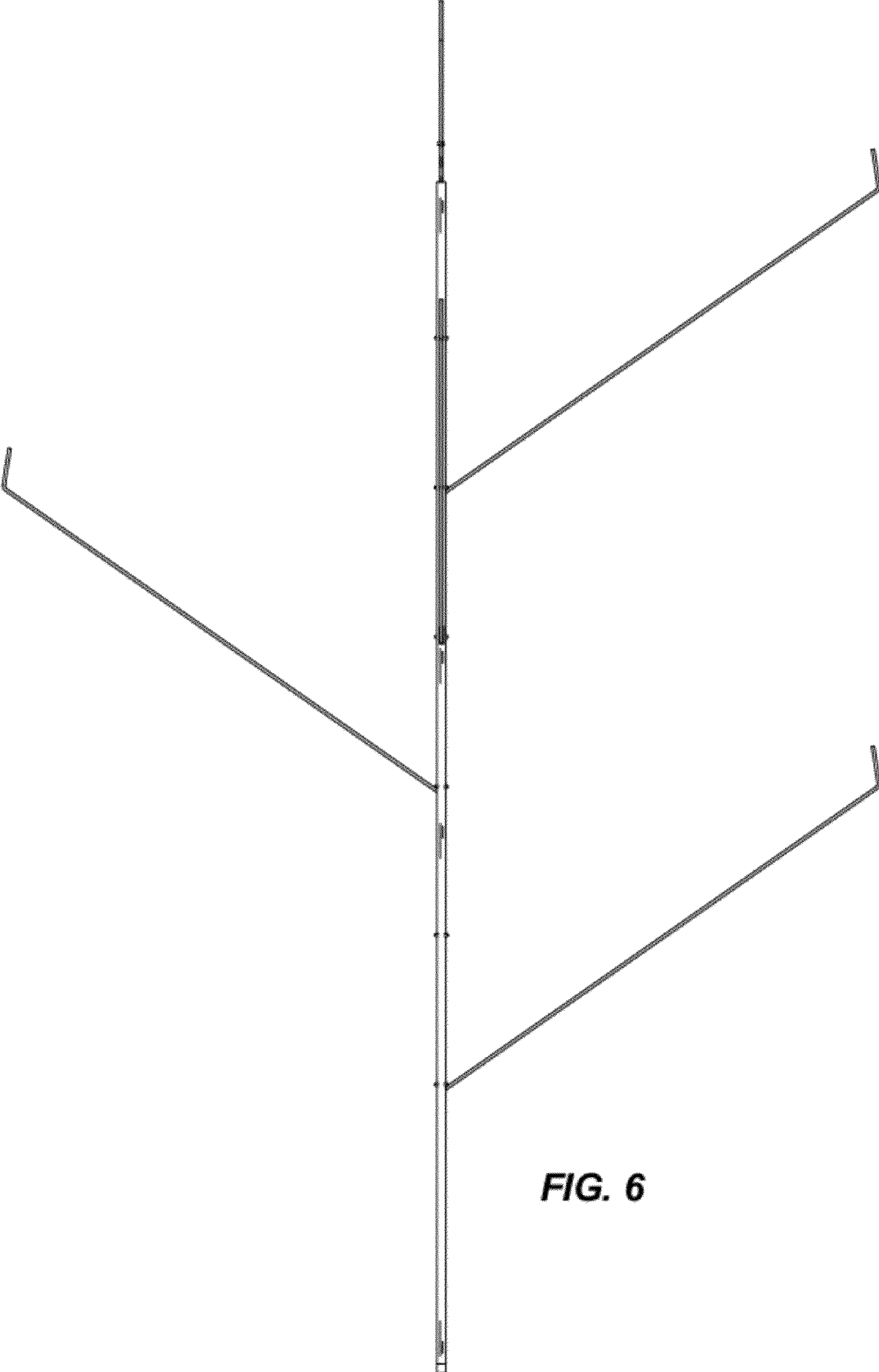

FIG. 6

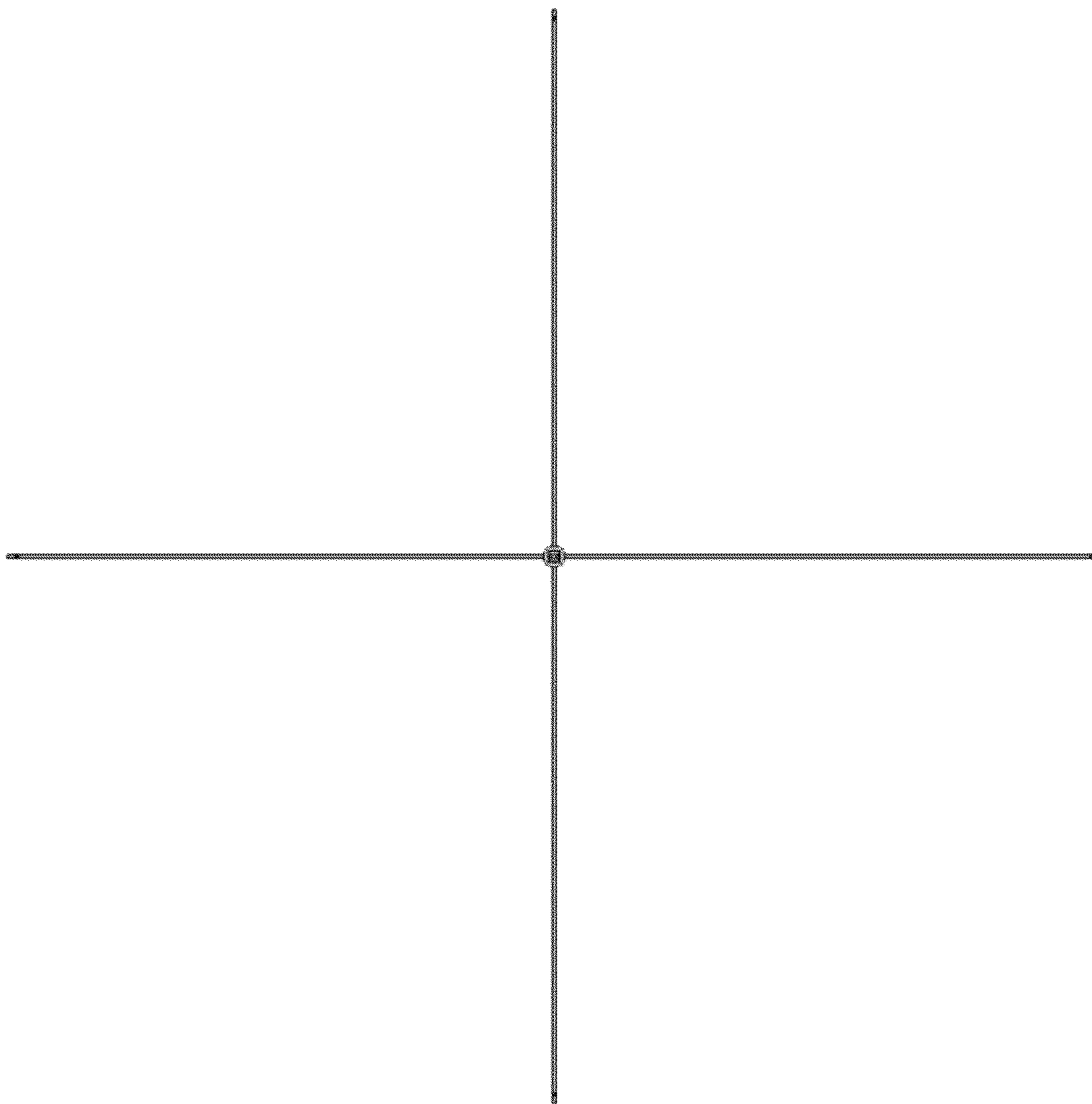

FIG. 7

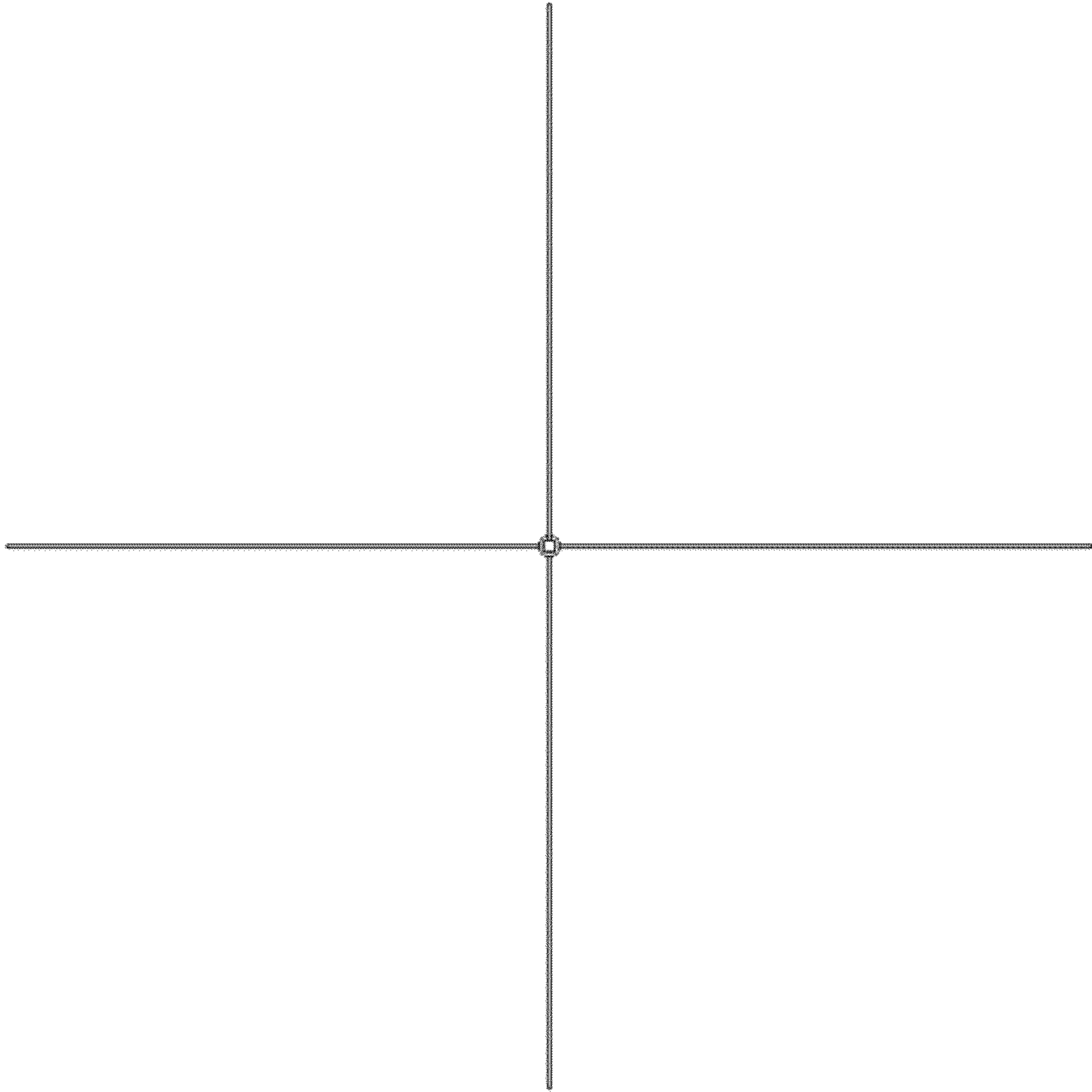

FIG. 8