



US00D671108S

(12) **United States Design Patent**  
**Rothbaum et al.**

(10) **Patent No.:** **US D671,108 S**  
(45) **Date of Patent:** **\*\* Nov. 20, 2012**

(54) **CASE WITH METAL BACK AND FRAMED FRONT FOR A CORD MANAGEMENT SYSTEM**

(75) Inventors: **Wayne Rothbaum**, New York, NY (US);  
**Allison S. Conner**, Brooklyn, NY (US);  
**Robert B. Curtis**, New York, NY (US);  
**Jonas K. Damon**, New York, NY (US);  
**Daniel A. Sanchez**, Brooklyn, NY (US)

(73) Assignee: **CJD LLC**, New York, NY (US)

(\*\*) Term: **14 Years**

(21) Appl. No.: **29/378,119**

(22) Filed: **Oct. 29, 2010**

(51) **LOC (9) Cl.** ..... **14-03**

(52) **U.S. Cl.** ..... **D14/250**

(58) **Field of Classification Search** ..... D3/201,  
D3/215, 218, 269, 273, 294; D14/140, 142,  
D14/203.3, 217, 218, 240, 242, 250-253,  
D14/299, 358, 440, 450; D13/103, 107,  
D13/108.119; 220/4.02; 224/119, 191, 240,  
224/241, 245, 682, 683; 248/309.1; 361/679.3,  
361/679.56; 379/454, 455; 455/575.1, 575.6,  
455/575.7, 575.8, 575.9; 190/100; 206/305,  
206/320

See application file for complete search history.

D582,405 S	12/2008	Andre et al.	.....	D14/250
D584,738 S	1/2009	Kim et al.		
D586,805 S	2/2009	Shi		
D587,267 S	2/2009	Wang	.....	D14/356
D597,515 S	8/2009	Kim	.....	D14/138 AD
D598,887 S	8/2009	Xiao et al.	.....	D14/138 AA
D603,603 S	11/2009	Laine et al.		
7,612,997 B1	11/2009	Diebel et al.	.....	361/679.56
D606,751 S	12/2009	Andre et al.		
D608,772 S	1/2010	Du et al.		
D609,463 S	2/2010	Bullen		
D610,807 S	3/2010	Bau		
D613,722 S	4/2010	Kaneta	.....	D14/138 G
D615,077 S	5/2010	Richardson et al.	.....	D14/250
D615,078 S	5/2010	Bradley		
D615,526 S	5/2010	Andre et al.		
D615,536 S	5/2010	Richardson et al.		
D616,361 S	5/2010	Huang		
D617,784 S	6/2010	Richardson et al.	.....	D14/250
D618,230 S	6/2010	Brown et al.	.....	D14/250
D619,130 S	7/2010	Fellig		
D619,361 S	7/2010	Andre et al.		
D619,574 S	7/2010	Richardson et al.	.....	D14/250
D620,000 S	7/2010	Bau		
D621,821 S	8/2010	Richardson et al.		
D622,716 S	8/2010	Andre et al.	.....	D14/250
7,782,610 B2	8/2010	Diebel et al.	.....	361/679.56
D623,180 S	9/2010	Diebel	.....	D14/250
D623,640 S	9/2010	Freeman	.....	D14/250
D624,064 S	9/2010	Esposito	.....	D14/250
D624,065 S	9/2010	Bosch et al.		
D624,304 S	9/2010	Danze et al.		
D624,532 S	9/2010	Huskinson	.....	D14/250
D624,533 S	9/2010	Richardson et al.	.....	D14/250
D624,908 S	10/2010	Huskinson	.....	D14/250
D624,909 S	10/2010	Huskinson	.....	D14/250
D626,119 S	10/2010	Fellig	.....	D14/250
D626,538 S	11/2010	Brown et al.		
D626,539 S	11/2010	Brown et al.		
D626,746 S	11/2010	Roman		
D626,936 S	11/2010	Yeo et al.		
D627,755 S	11/2010	Yang		
D627,771 S	11/2010	Smith et al.		
D627,778 S	11/2010	Akana et al.		
D628,374 S	12/2010	Lee et al.		
D628,994 S	12/2010	Griffin, Jr. et al.		
D629,786 S	12/2010	Andre et al.		
D630,614 S	1/2011	Lee		
D633,885 S	3/2011	Kim		
D637,590 S	5/2011	Michie et al.		
D637,592 S	5/2011	Magness et al.		
D638,005 S	5/2011	Richardson et al.		
D638,006 S	5/2011	Chang		

(56) **References Cited**

U.S. PATENT DOCUMENTS

D364,850 S 12/1995 Estrada et al.  
D384,942 S 10/1997 Vinuela  
D396,882 S 8/1998 Neal, Jr.  
D461,477 S 8/2002 Pentz  
D467,247 S 12/2002 Pentz  
D513,617 S 1/2006 Tierney  
D525,986 S 8/2006 Kim  
D539,277 S 3/2007 Okada et al.  
D556,681 S 12/2007 Kim  
D574,819 S 8/2008 Andre et al.  
D575,056 S 8/2008 Tan ..... D3/218  
D581,151 S 11/2008 Aipa  
D582,149 S 12/2008 Tan ..... D3/218

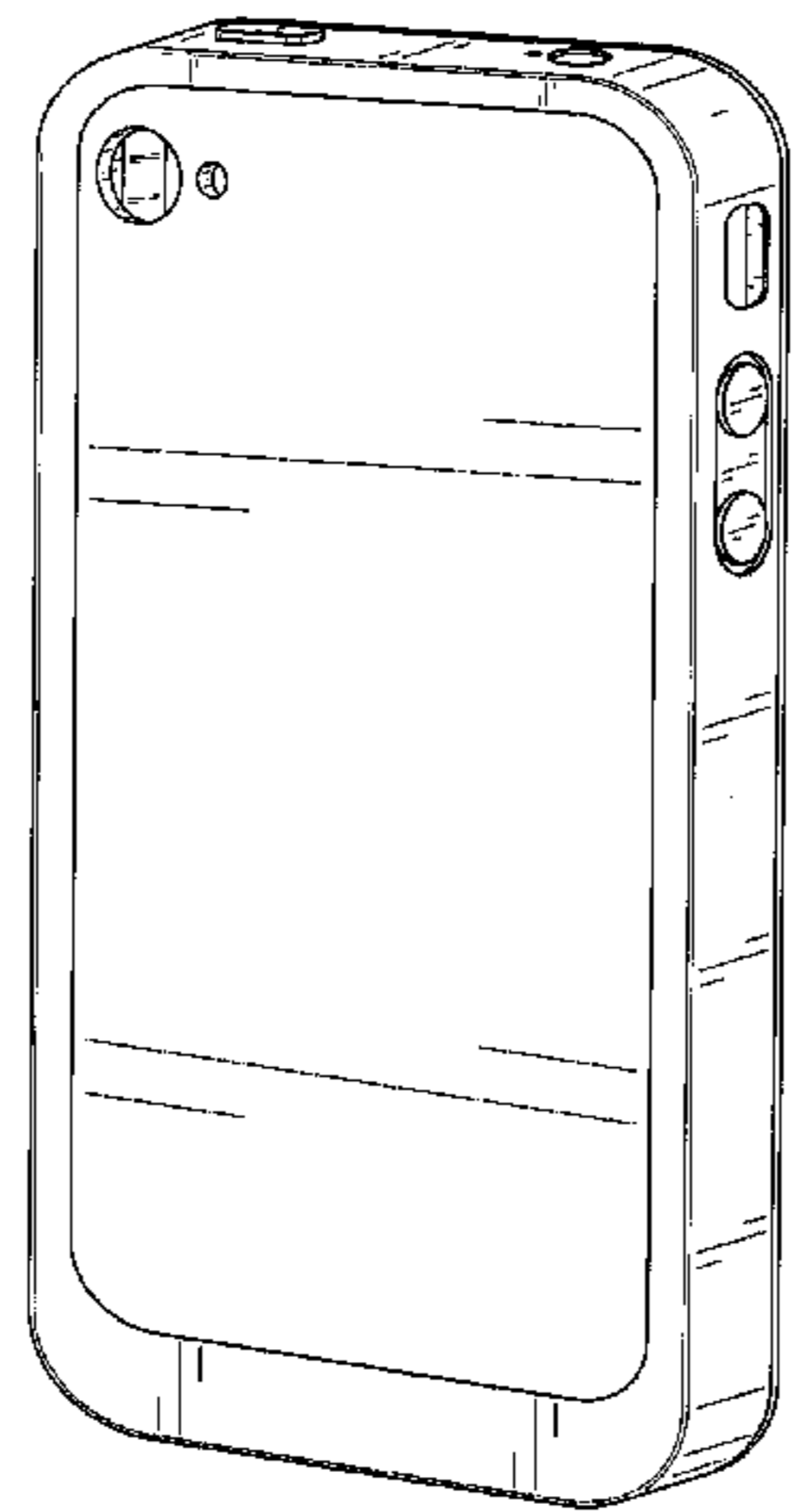

D640,246 S	6/2011	Liu et al.	
D641,345 S	7/2011	Gonzalez	
D642,169 S	7/2011	Andre et al.	
D642,170 S	7/2011	Johnson et al.	
D643,029 S	8/2011	Feng	
D647,519 S *	10/2011	Rothbaum et al.	D14/250
2002/0073516 A1	6/2002	Behar	24/306
2007/0023559 A1	2/2007	Scapillato et al.	242/400.1
2007/0099681 A1	5/2007	Kielland	455/575.1
2007/0165371 A1	7/2007	Brandenburg	361/683
2009/0114556 A1	5/2009	Tai et al.	
2010/0203931 A1	8/2010	Hynecek et al.	
2010/0300909 A1	12/2010	Hung	

OTHER PUBLICATIONS

Whitson, G., "Metal iPhone 4 Cover Protects Your iPhone 4 Without the Bulk of a Case," <http://lifehacker.com/5666069/metal-iphone-4-cover-protects-your-iphone-4-without-the-bulk-of-a-case>, Oct. 17, 2010, 3 pages.

Guy, N., "2012 iPhone + iPod Buyers' Guide, Apple iPhone 4 Bumpers," <http://www.ilouonge.com/index.php/reviews/entry/apple-iphone-4-bumper>, Mar. 9, 2011, 16 pages.

Wayne Philip Rothbaum, U.S. Appl. No. 29/375,648, filed Sep. 24, 2010, Notice of Allowance and Fees Due, Date Mailed Jul. 18, 2011, 2 pages.

Wayne Philip Rothbaum, U.S. Appl. No. 29/385,172, filed Feb. 9, 2011, Final Office Action, Notification Date Sep. 6, 2011, 11 pages.

Wayne Philip Rothbaum, U.S. Appl. No. 29/385,174, filed Feb. 9, 2011, Office Action, Notification Date Sep. 2, 2011, 13 pages.

Replacement Polished Stainless Steel Back Cover w/ Metal Tabs for Apple iPhone 4, <http://cnn.cnshop/replacement-polished-stainless-steel-back-cover-metal-tabs-apple-iphone-4-hexagonal>, retrieved Jul. 1, 2011, 2 pages.

[gizmodo.com](http://gizmodo.com), *Metal iPhone 4 Cover Protects Your iPhone 4 Without the Bulk of a Case*, [gizmodo.com/5666388/metal-iphone-4-cover-protects-your-iphone-4-without-the-bulk-of-a-case](http://gizmodo.com/5666388/metal-iphone-4-cover-protects-your-iphone-4-without-the-bulk-of-a-case), downloaded Oct. 22, 2010, 1 page.

Apple iPhone 4 Bumper—White, Apple Store, <http://store.apple.com/us/product/MC668ZM/B>, 2010, 2 pages.

\* cited by examiner

*Primary Examiner* — Raphael Barkai

*Assistant Examiner* — Randall Gholson

(74) *Attorney, Agent, or Firm* — Morgan, Lewis & Bockius LLP

(57) **CLAIM**

An ornamental design for a case with metal back and framed front for a cord management system, as shown and described.

**DESCRIPTION**

The present application relates to U.S. Design patent application Ser. No. 29/378,110 filed Oct. 29, 2010, entitled Case with Metal Back and Framed Front for a Cord Management System, and to U.S. Design patent application Ser. No. 29/378,118 filed Oct. 29, 2010, entitled Case with Metal Back and Framed Front for a Cord Management System. The present application also relates to U.S. Design patent application Ser. No. 29/377,918 filed Oct. 27, 2010, entitled Case with Combined Metal and Plastic Back for a Cord Management System, and to U.S. Design patent application Ser. No. 29/377,919 filed Oct. 27, 2010, entitled Case with Combined Metal and Plastic Back for a Cord Management System, and to U.S. Design patent application Ser. No. 29/377,921 filed Oct. 27, 2010, entitled Case with Combined Metal and Plastic Back for a Cord Management System, and to U.S. Design patent application Ser. No. 29/376,257, filed Oct. 4, 2010; U.S. Design patent application Ser. No. 29/376,428 filed Oct.

6, 2010, entitled Case with Metal Back and Band Edge for a Cord Management System, and to U.S. Design patent application Ser. No. 29/376,430 filed Oct. 6, 2010, entitled Case with Metal Back and Band Edge for a Cord Management System. The present application also relates to U.S. Design patent application Ser. No. 29/375,648, entitled Case with Metal Back for a Cord Management System, filed Sep. 24, 2010, and to U.S. Design patent application Ser. No. 29/375,649 filed Sep. 24, 2010, entitled Case with Metal Back for a Cord Management System, and to U.S. Design patent application Ser. No. 29/375,651 filed Sept. 24, 2010, entitled Case with Metal Back for a Cord Management System, and to U.S. Design patent application Ser. No. 29/376,041 filed Sep. 30, 2010, entitled Case with Metal Back for a Cord Management System, the disclosures of which are all incorporated herein by reference in their entirety.

FIG. 1 is a back perspective view of our new design of a case with metal back and framed front for a cord management system;

FIG. 2 is a back perspective view of another embodiment of our new design of a case with metal back and framed front for a cord management system;

FIG. 3 is a back perspective view of yet another embodiment of our new design of a case with metal back and framed front for a cord management system;

FIG. 4 is a first side view of the embodiments of FIGS. 1-3;

FIG. 5 is a second side view of the embodiment of FIG. 1;

FIG. 6 is a second side view of the embodiment of FIG. 2;

FIG. 7 is a second side view of the embodiment of FIG. 3;

FIG. 8 is a top side view of the embodiments of FIGS. 1 and 2;

FIG. 9 is a top side view of the embodiment of FIG. 3;

FIG. 10 is a bottom side view of the embodiments of FIGS. 1 and 2;

FIG. 11 is a bottom side view of the embodiment of FIG. 3;

FIG. 12 is a back view of the embodiments of FIGS. 1 and 2;

FIG. 13 is a back view of the embodiment of FIG. 3;

FIG. 14 is a front perspective view of any of the embodiments of FIGS. 1-3, provided for illustrative purposes;

FIG. 15 is a front view of the embodiments of FIGS. 1 and 2;

FIG. 16 is a front view of the embodiment of FIG. 3;

FIG. 17 is a front perspective view of any of the embodiments of FIGS. 1-3, illustrating these embodiments used in conjunction with an object;

FIG. 18 is a back perspective view of any of the embodiments of FIGS. 1-3, illustrating these embodiments used in conjunction with two objects;

FIG. 19 is a back perspective view of any of the embodiments of FIGS. 1-3, illustrating these embodiments used in conjunction with three objects;

FIG. 20 is another back perspective view of any of the embodiments of FIGS. 1-3, illustrating these embodiments used in conjunction with three objects;

FIG. 21 is an exploded back perspective view of the embodiment of FIG. 1;

FIG. 22 is an exploded back perspective view of the embodiment of FIG. 2; and,

FIG. 23 is an exploded back perspective view of the embodiment of FIG. 3.

The broken lines showing elements of the case with metal back and band edge for cord management system in the above described Figures are for illustrative purposes only and form no part of the claimed design.

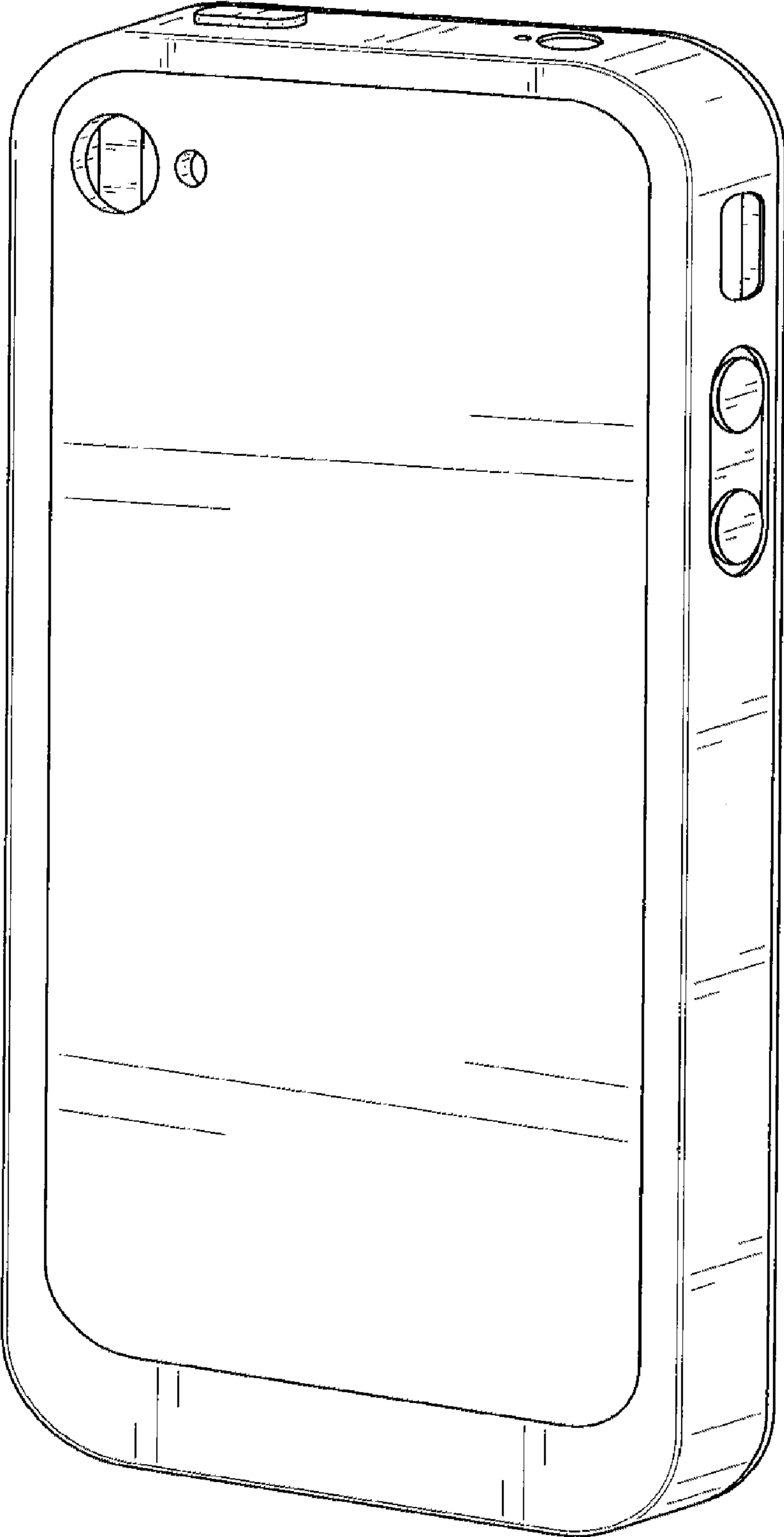

FIG. 1

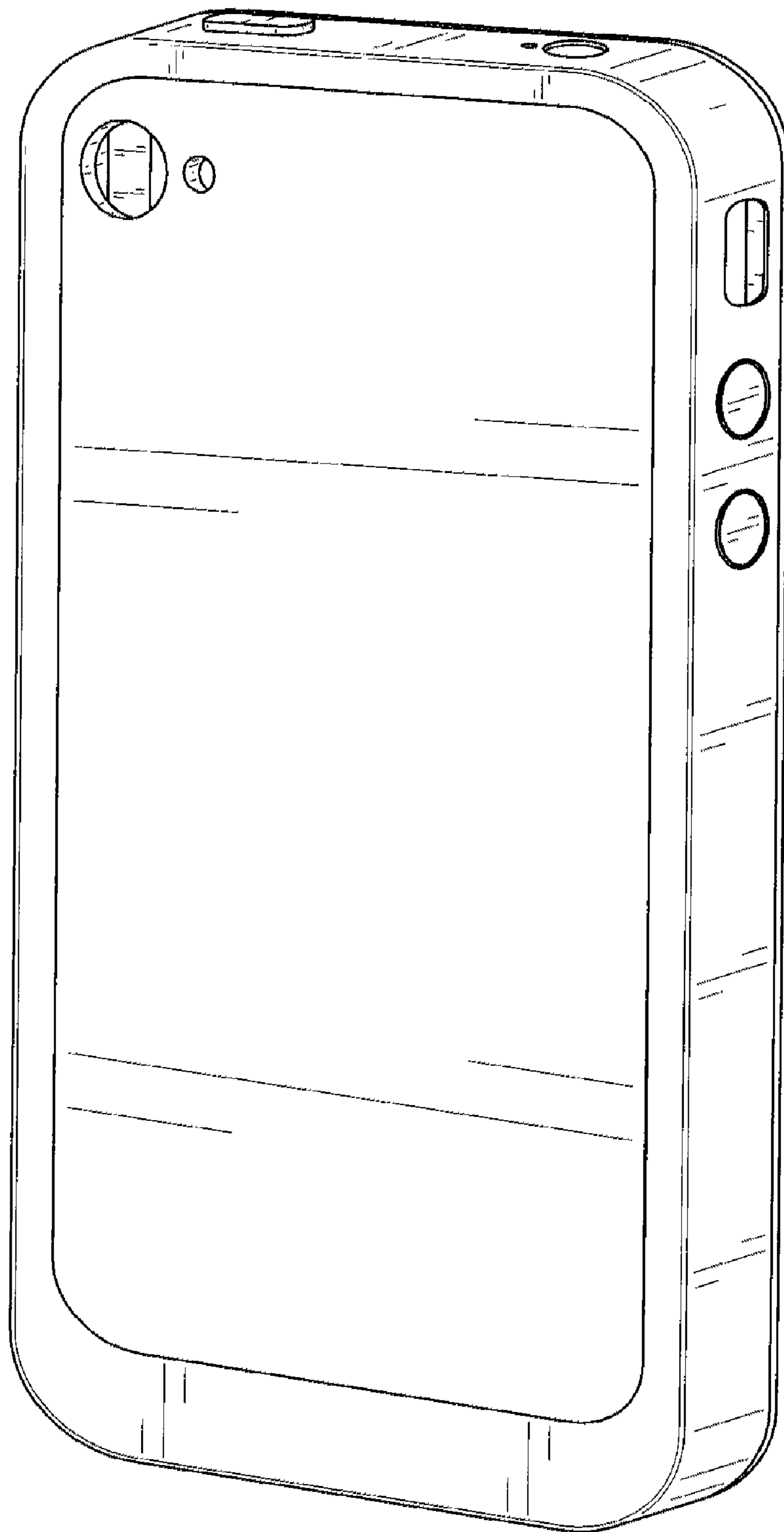

FIG. 2

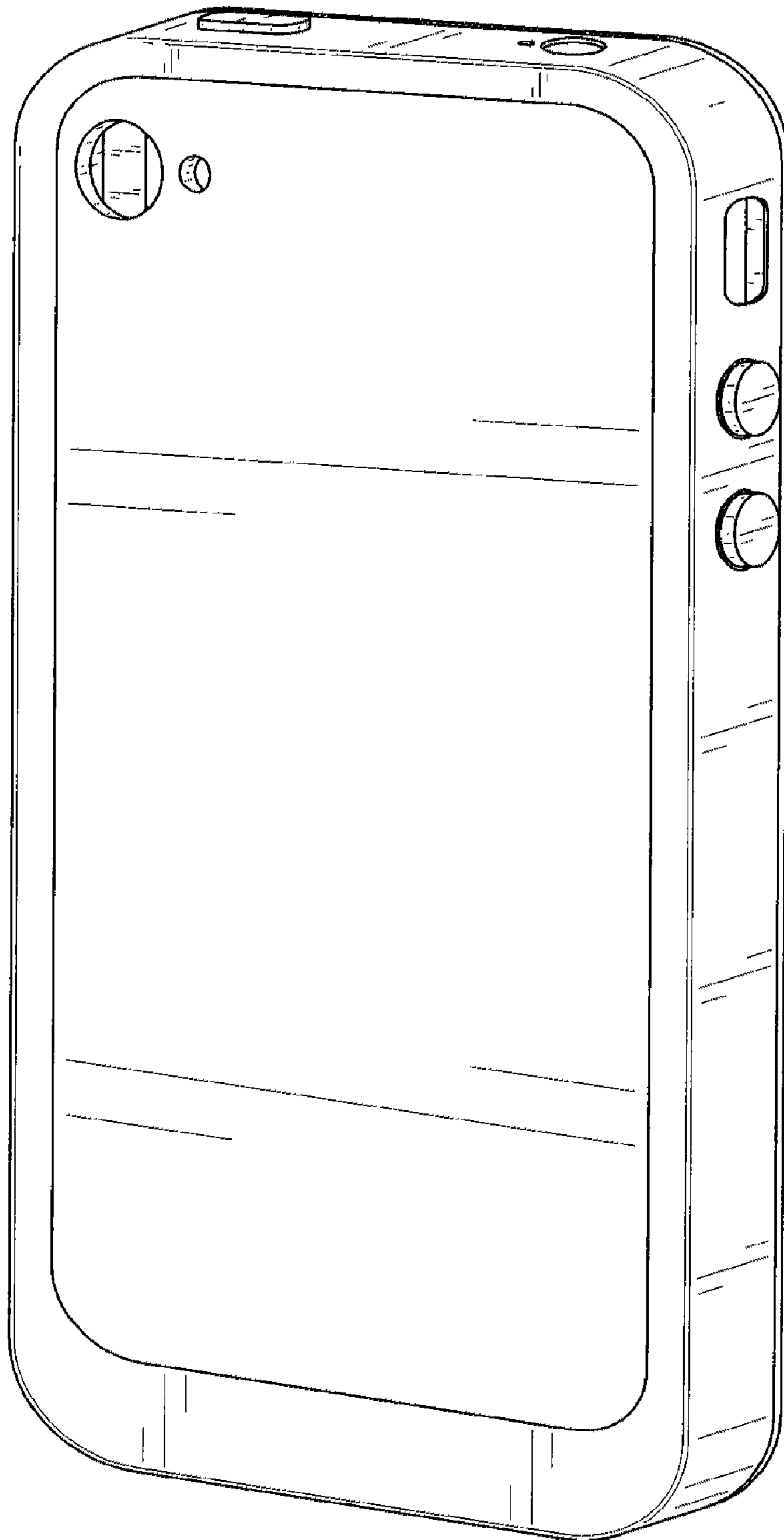

FIG. 3

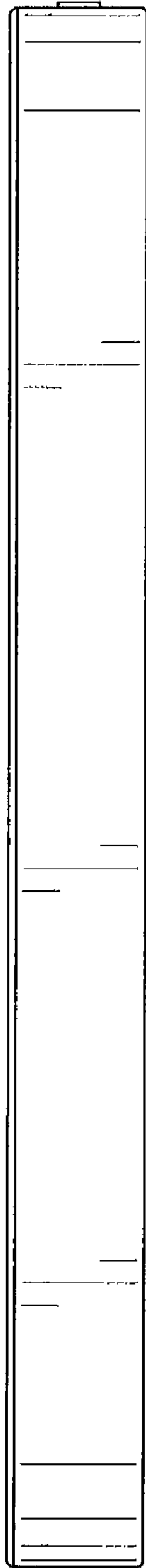

FIG. 4

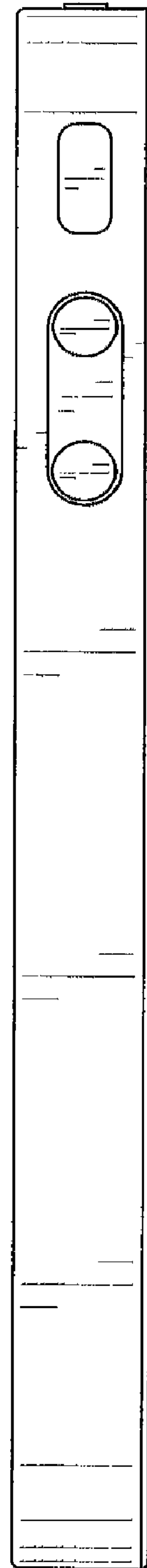

FIG. 5

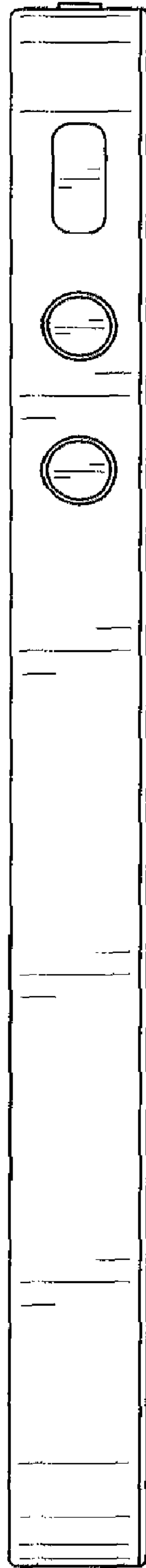

FIG. 6

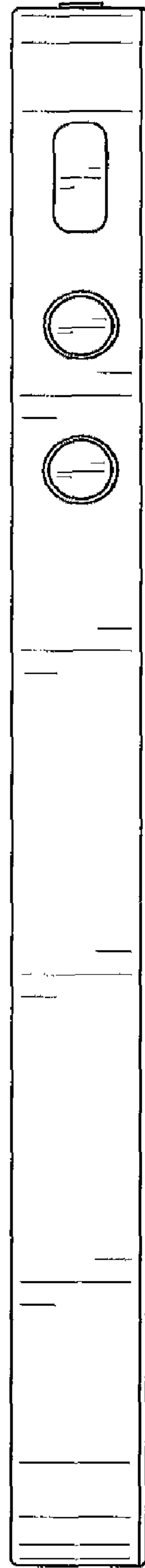

FIG. 7



FIG. 8

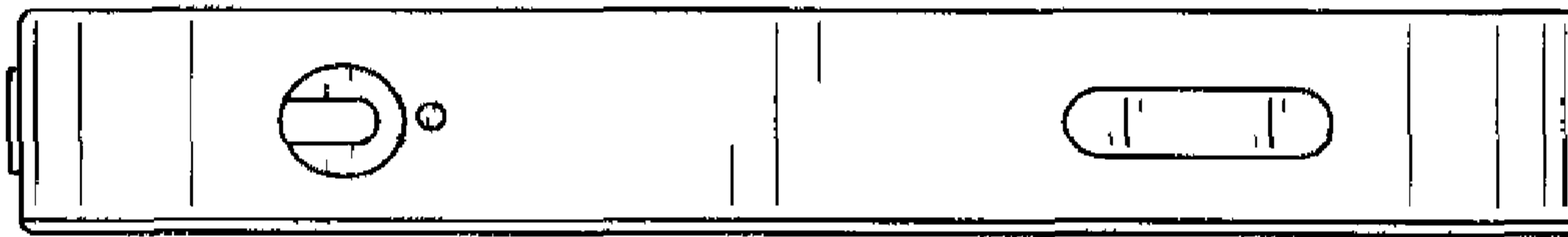

FIG. 9



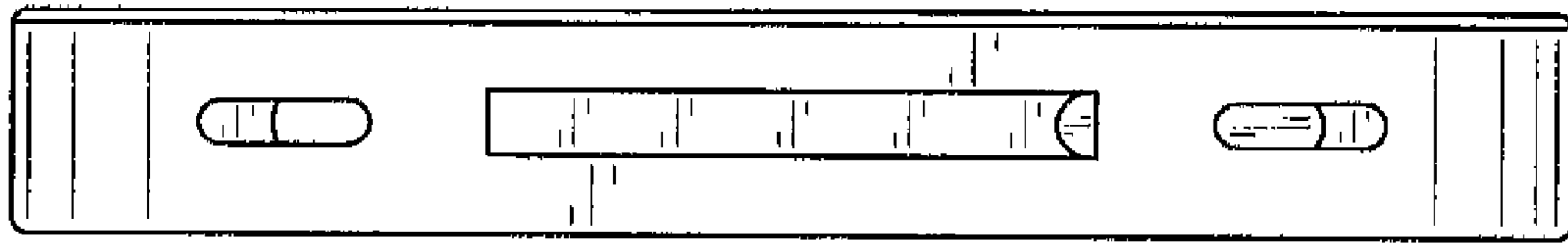

FIG. 10

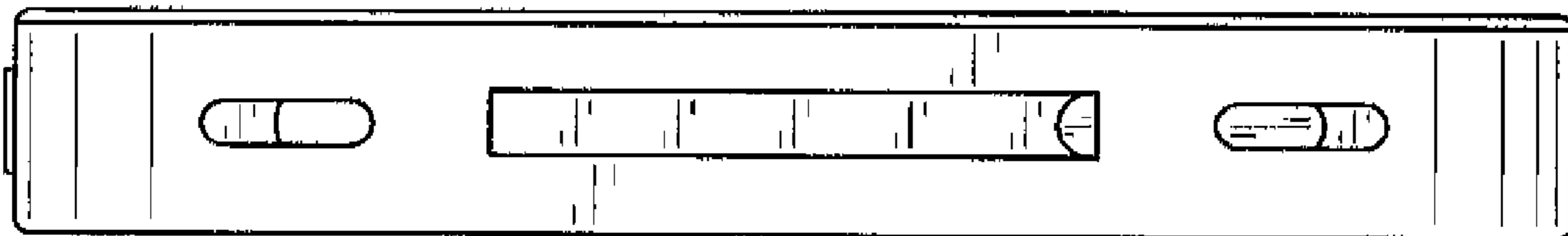

FIG. 11

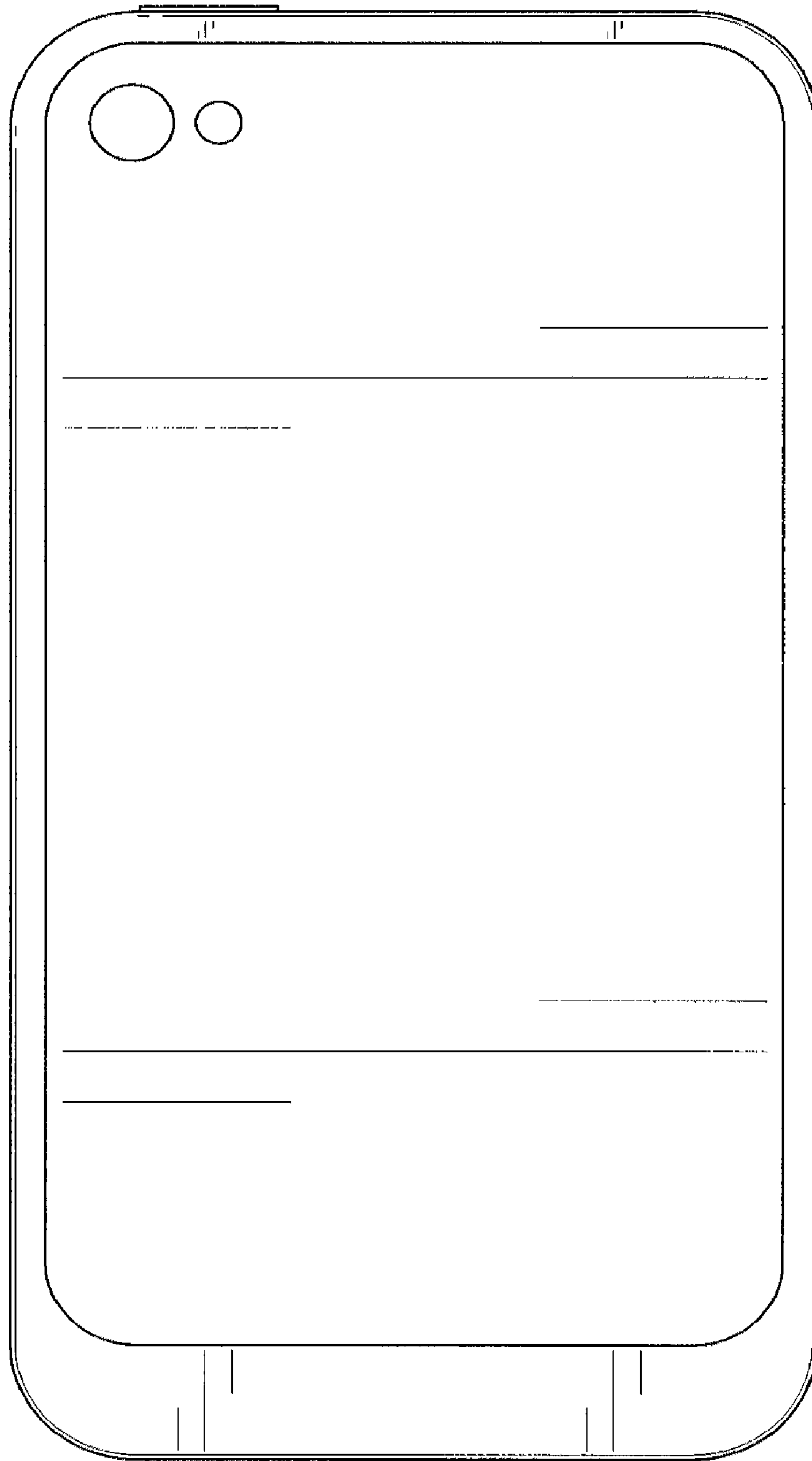

FIG. 12

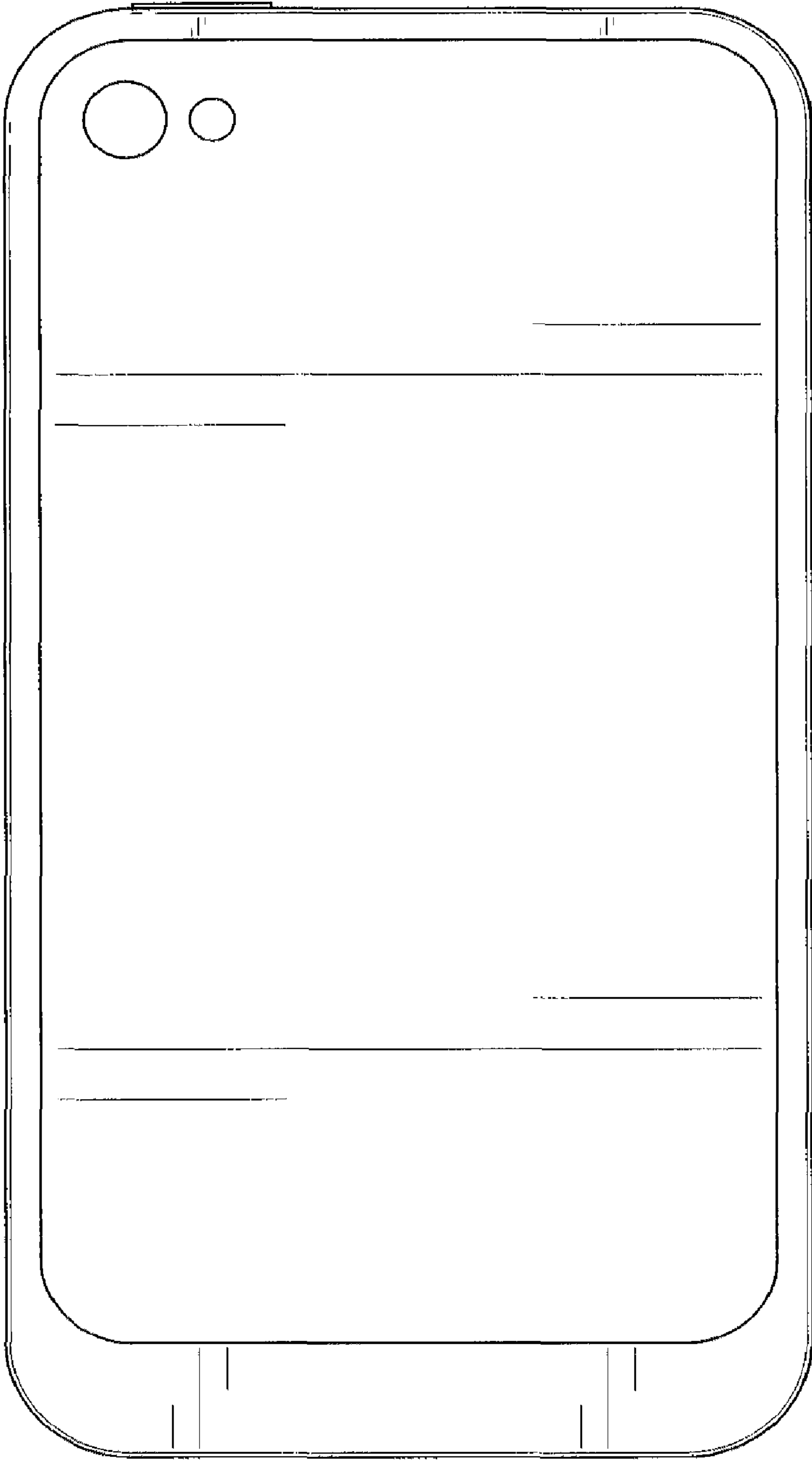

FIG. 13

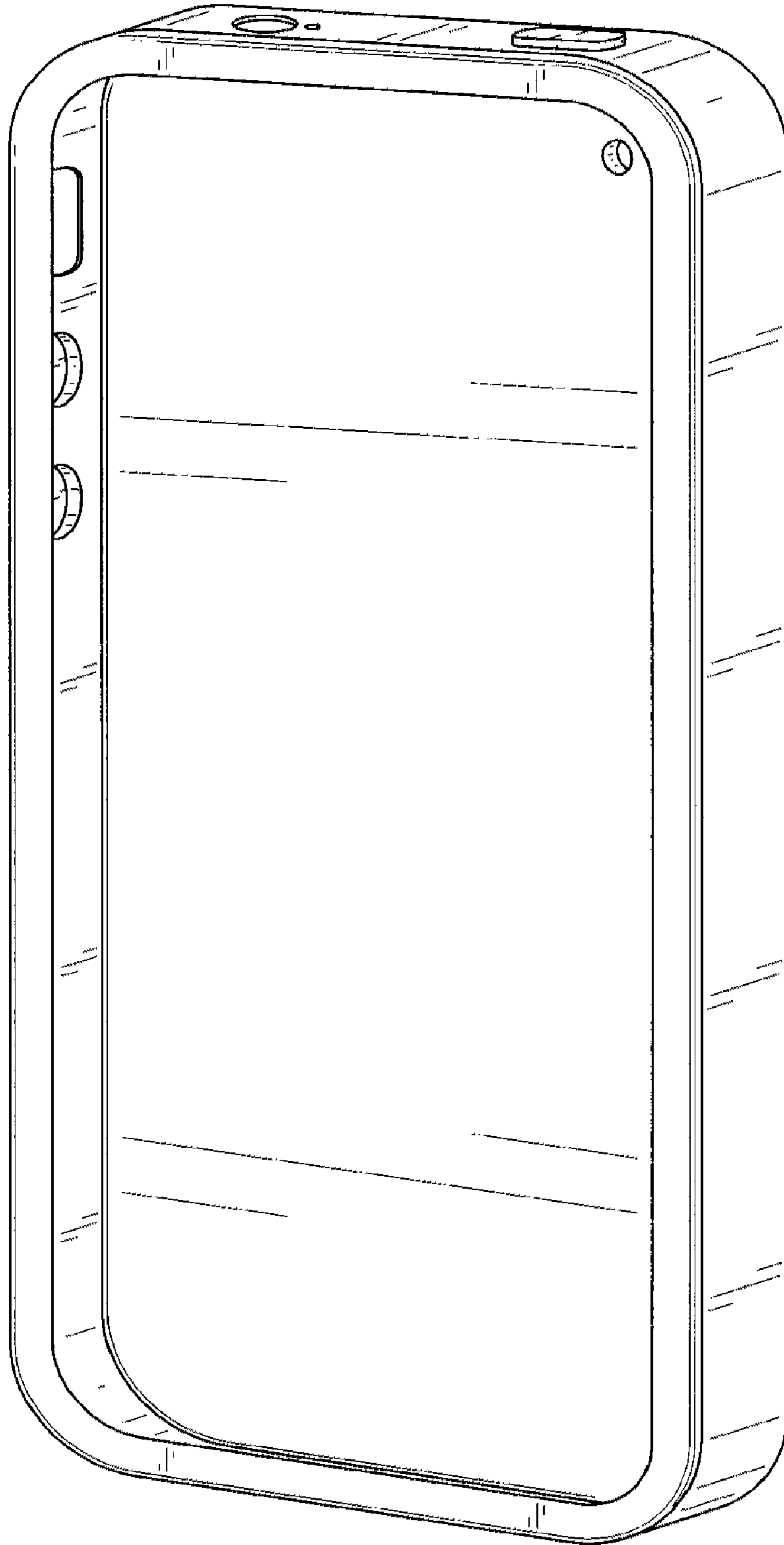

FIG. 14

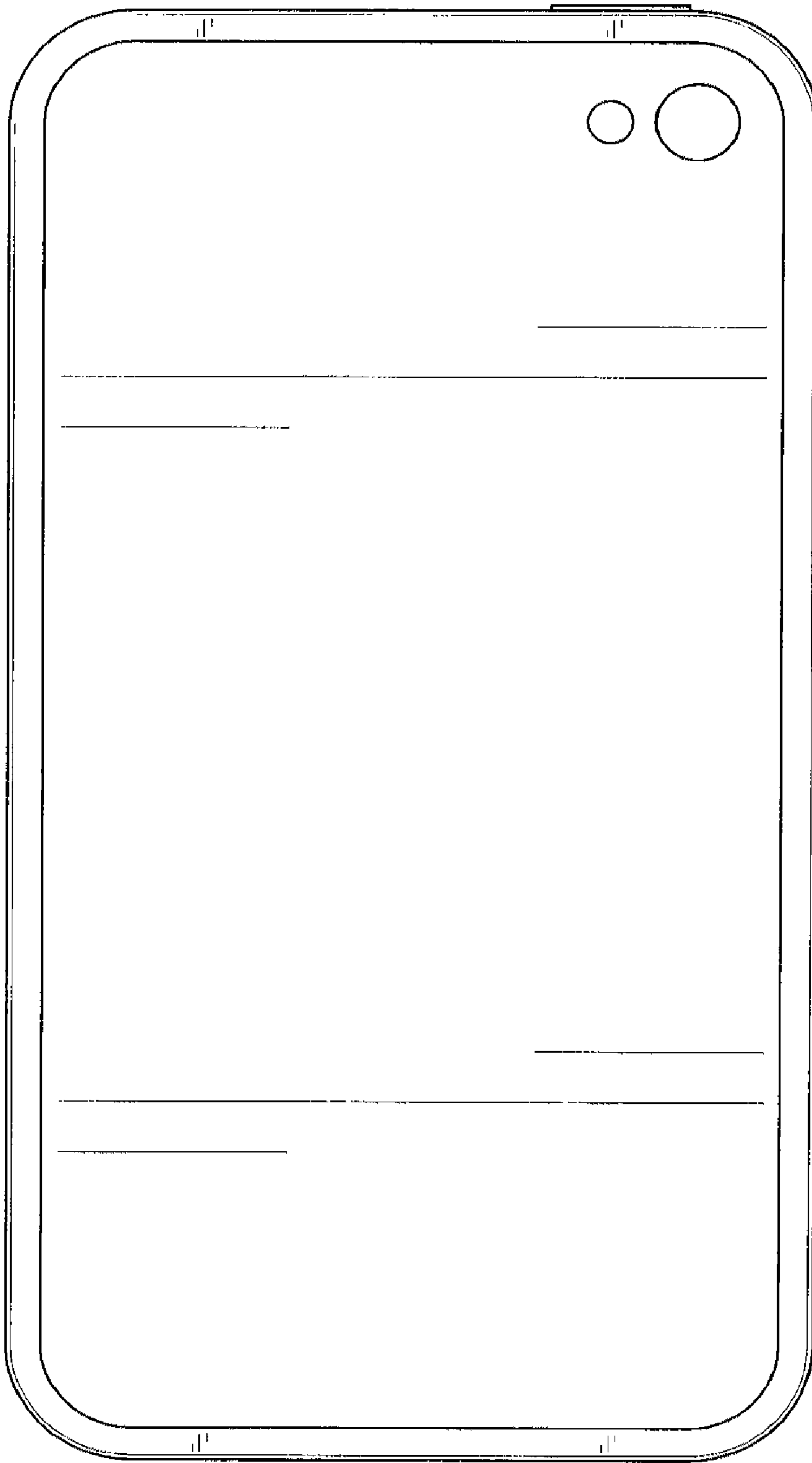

FIG. 15

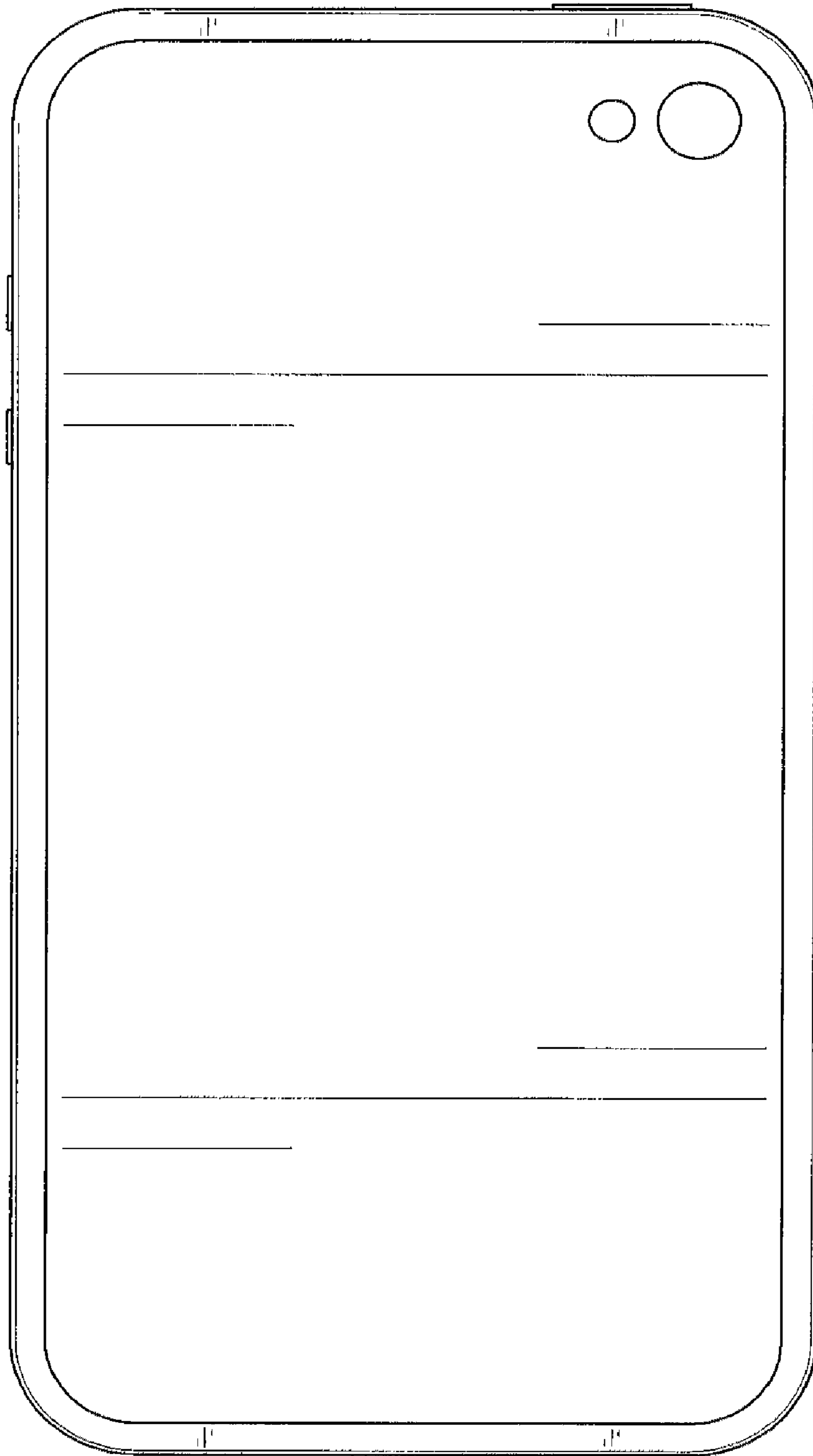

FIG. 16

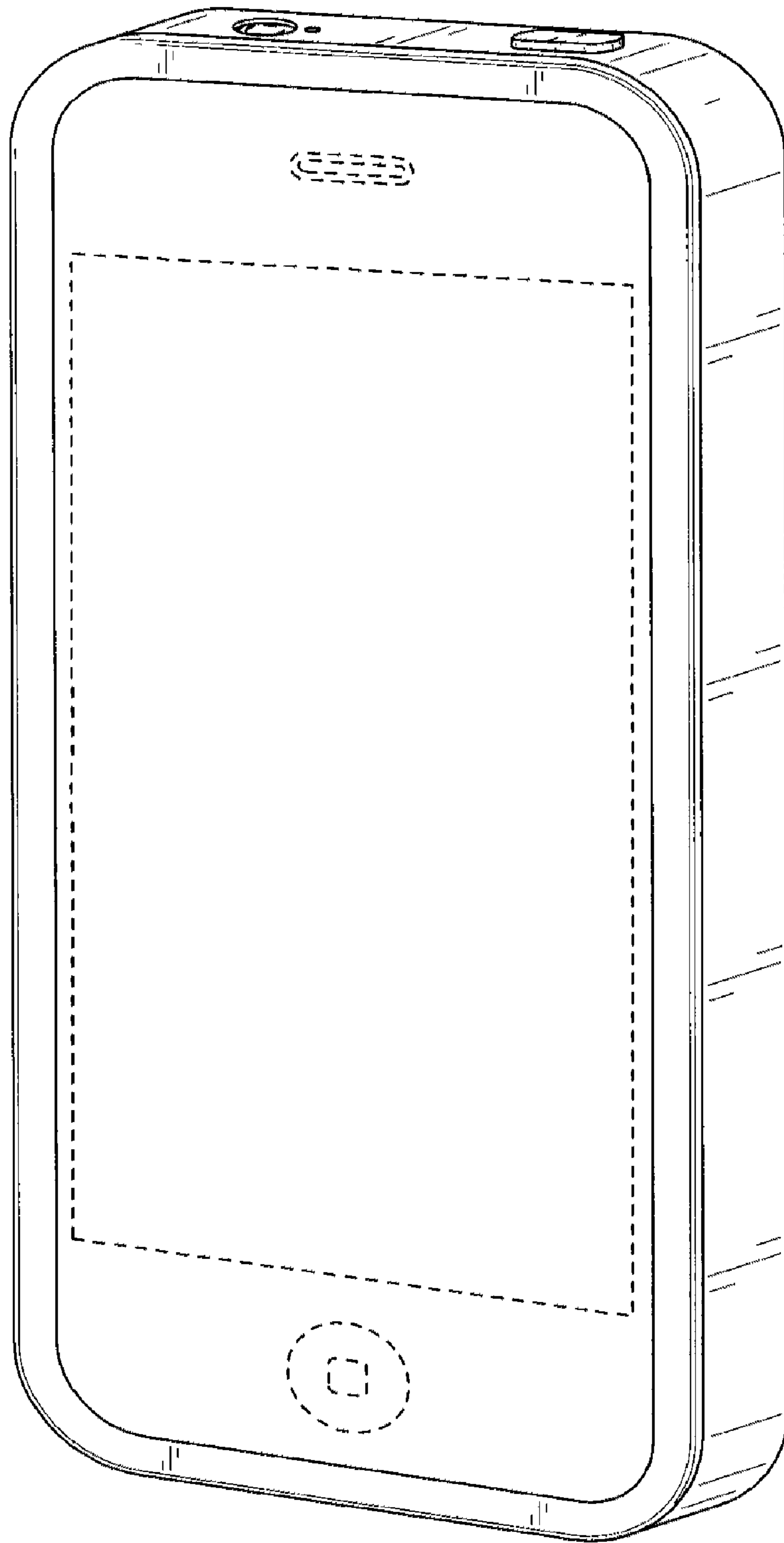

FIG. 17

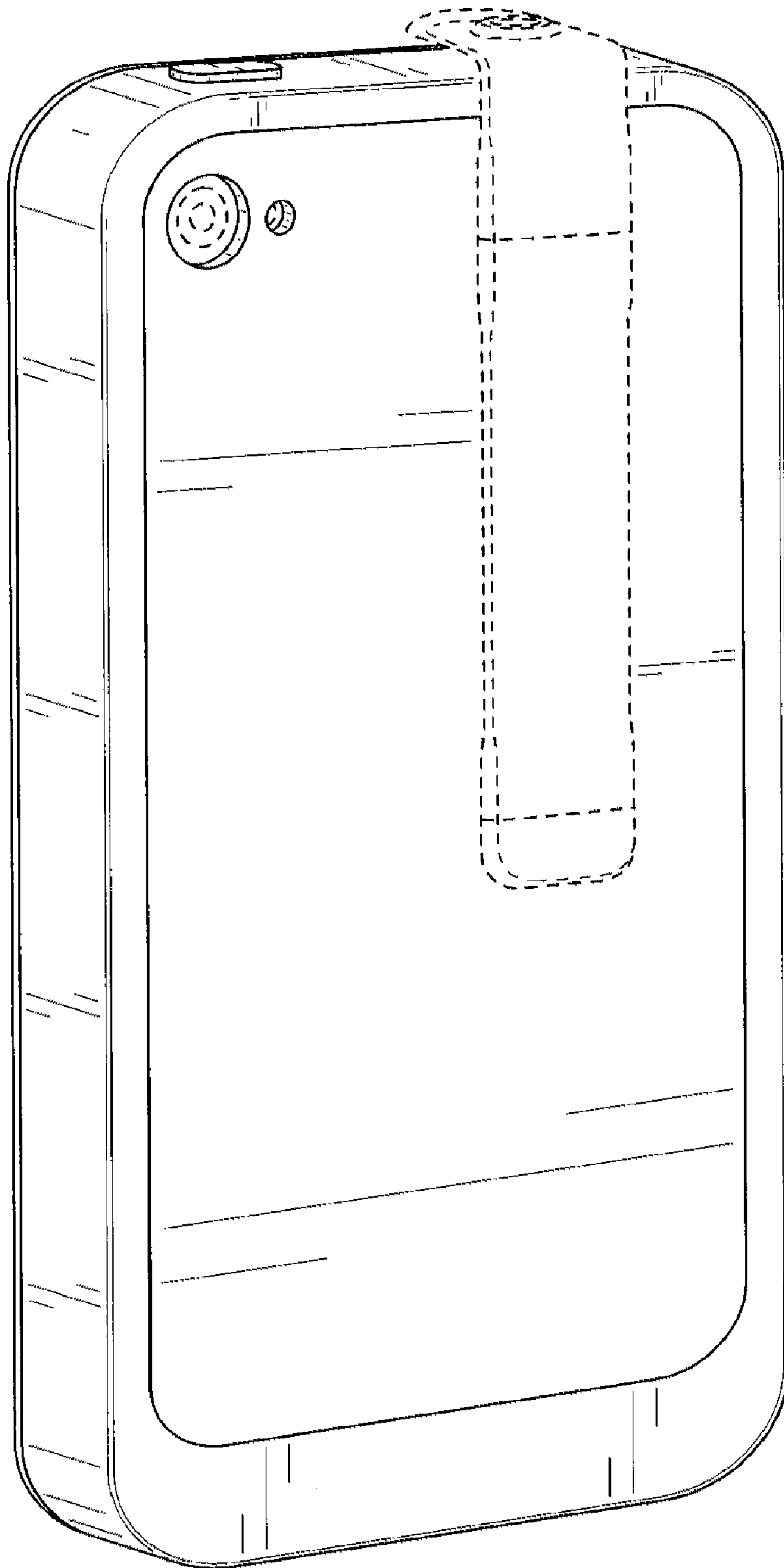

FIG. 18



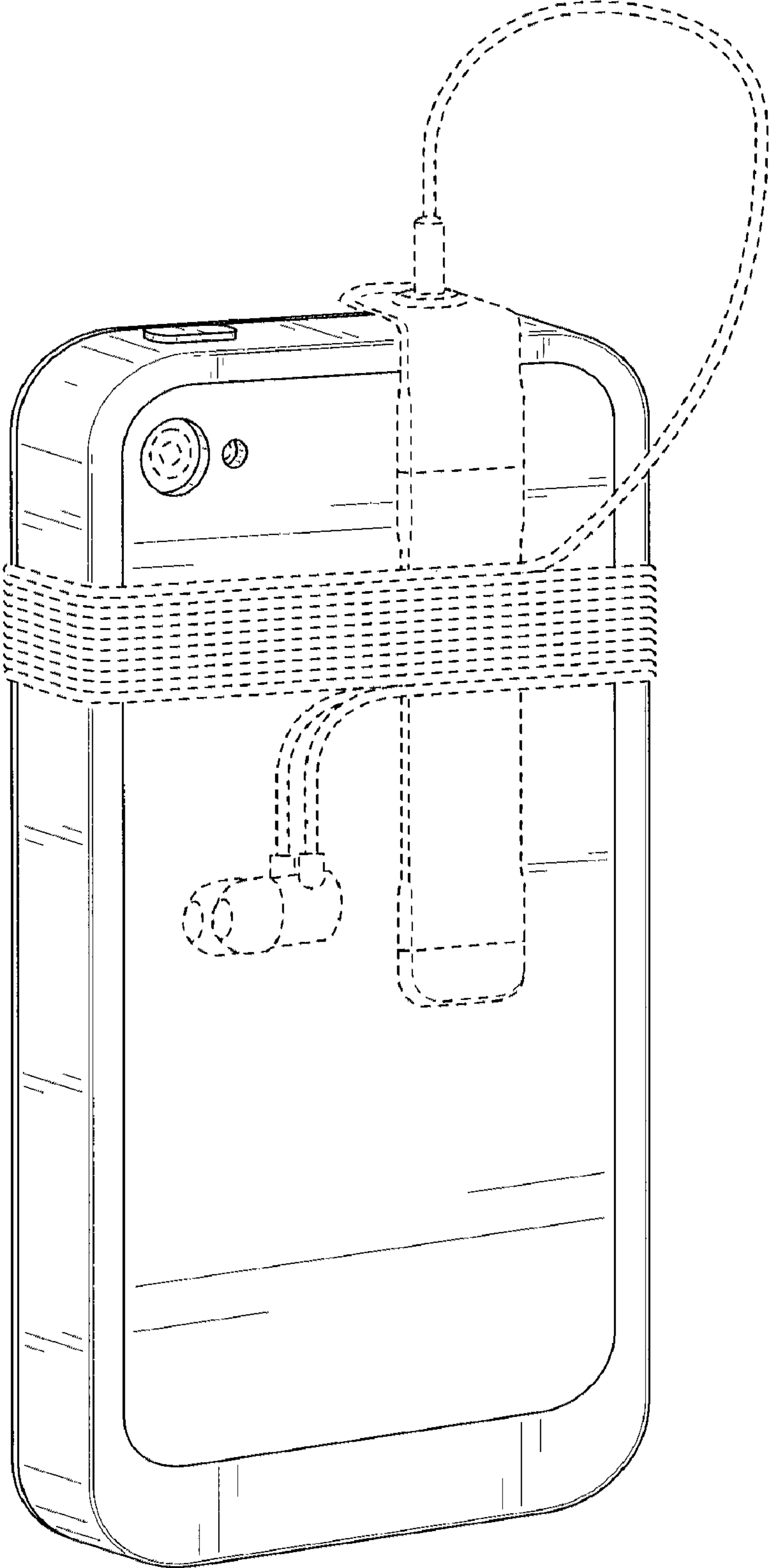

FIG. 19

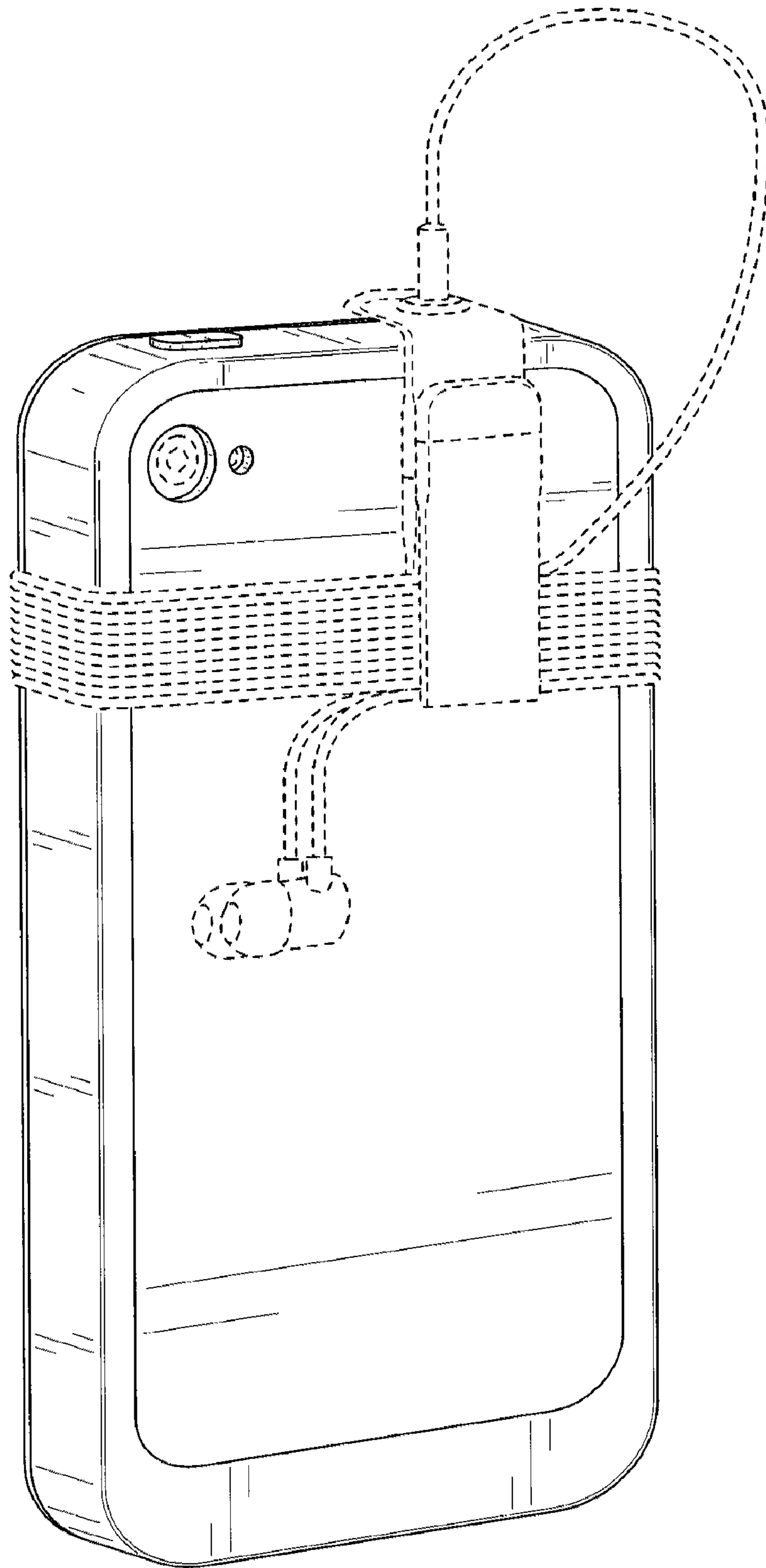

FIG. 20

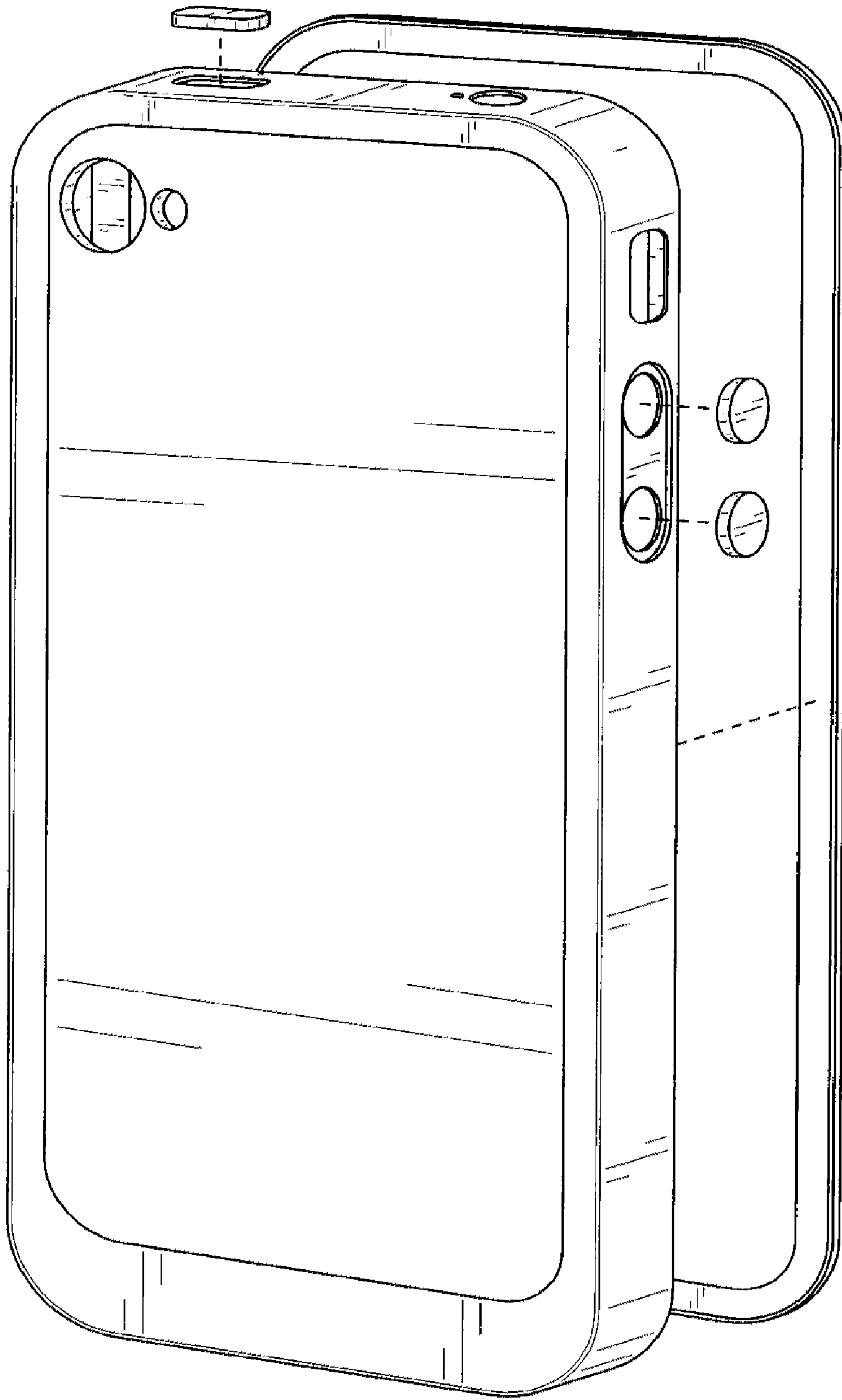

FIG. 21

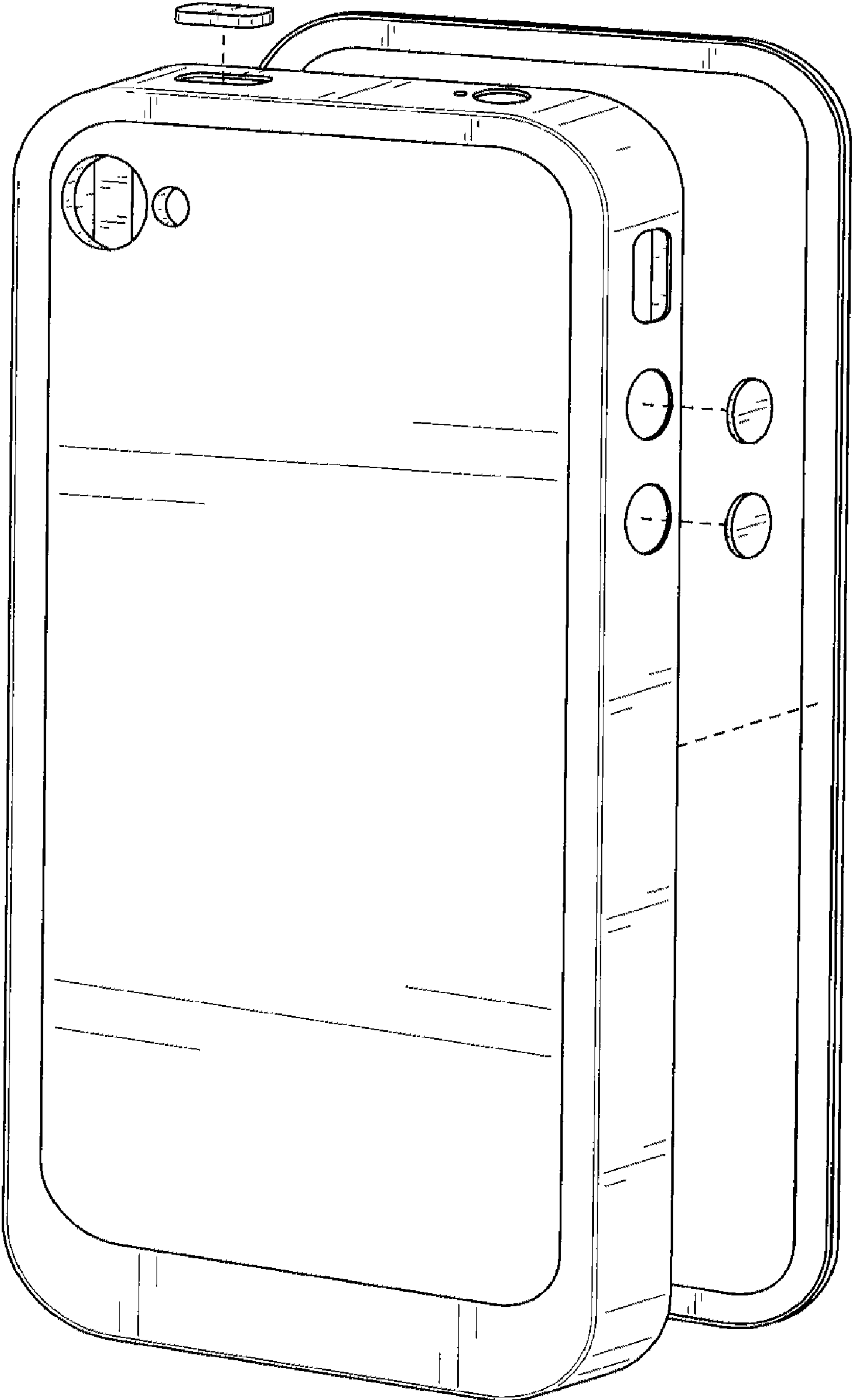

FIG. 22

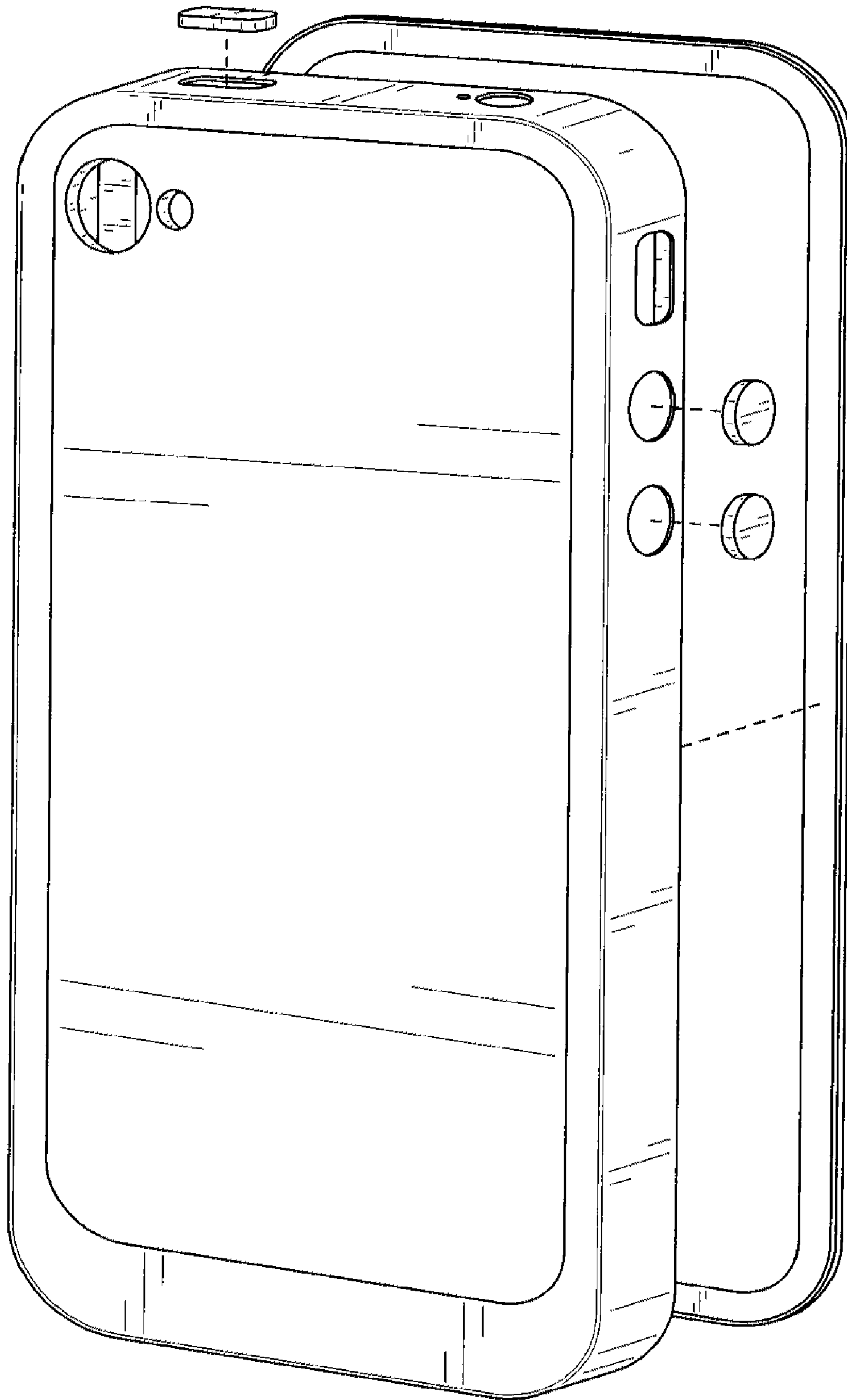

FIG. 23