



US00D670950S

(12) **United States Design Patent**
Price

(10) **Patent No.:** **US D670,950 S**

(45) **Date of Patent:** **** Nov. 20, 2012**

(54) **BORDER FOR MATTRESSES**

(75) Inventor: **Elvin C. Price**, Dacula, GA (US)

(73) Assignee: **Atlanta Attachment Company**,
Lawrenceville, GA (US)

(**) Term: **14 Years**

(21) Appl. No.: **29/419,261**

(22) Filed: **Apr. 26, 2012**

(51) **LOC (9) Cl.** **06-09**

(52) **U.S. Cl.** **D6/605**

(58) **Field of Classification Search** D6/595,
D6/596, 601, 604, 605; 5/690, 703, 704,
5/716, 717, 739, 740, 657.5, 675, 680, 688,
5/700, 706, 737, 499

See application file for complete search history.

(56) **References Cited**

U.S. PATENT DOCUMENTS

765,756 A * 7/1904 Stratton 5/703

(Continued)

Primary Examiner — Janice Seeger

(74) *Attorney, Agent, or Firm* — Womble Carlyle Sandridge
& Rice LLP

(57) **CLAIM**

The ornamental design for a border for mattresses, as shown
and described.

DESCRIPTION

FIG. 1 is a front perspective view of a border for mattresses
showing my new design in accordance with a first embodi-
ment.

FIG. 2 is a left elevation view of the border for mattresses of
FIG. 1.

FIG. 3 is a right elevation view of the border for mattresses of
FIG. 1.

FIG. 4 is a rear elevation view of the border for mattresses of
FIG. 1.

FIG. 5 is a front elevation view of the border for mattresses of
FIG. 1.

FIG. 6 is a top plan view of the border for mattresses of FIG.
1, which is identical to the opposite, bottom plan view of the
border for mattresses of FIG. 1.

FIG. 7 is an enlarged view of a corner of the border for
mattresses and is illustrative of a portion of each of FIGS. 1-5
showing the design shown in closer detail.

FIG. 8 is a perspective view of a border for mattresses show-
ing my new design in accordance with a second embodiment.

FIG. 9 is a left elevation view of the border for mattresses of
FIG. 8.

FIG. 10 is a right elevation view of the border for mattresses
of FIG. 8.

FIG. 11 is a rear elevation view of the border for mattresses of
FIG. 8.

FIG. 12 is a front elevation view of the border for mattresses
of FIG. 8.

FIG. 13 is a top plan view of the border for mattresses of FIG.
8, which is identical to the opposite, bottom plan view of the
border for mattresses of FIG. 8.

FIG. 14 is a perspective view of a border for mattresses
showing my new design in accordance with a third embodi-
ment.

FIG. 15 is a left elevation view of the border for mattresses of
FIG. 14.

FIG. 16 is a right elevation view of the border for mattresses
of FIG. 14.

FIG. 17 is a rear elevation view of the border for mattresses of
FIG. 14.

FIG. 18 is a front elevation view of the border for mattresses
of FIG. 14; and,

FIG. 19 is a top plan view of the border for mattresses of FIG.
14, which is identical to the opposite, bottom plan view of the
border for mattresses of FIG. 14.

The broken lines shown in the drawings are for environmental
purposes only and form no part of the claimed design. The
areas encompassed by the broken lines form no part of the
claimed design.

1 Claim, 13 Drawing Sheets

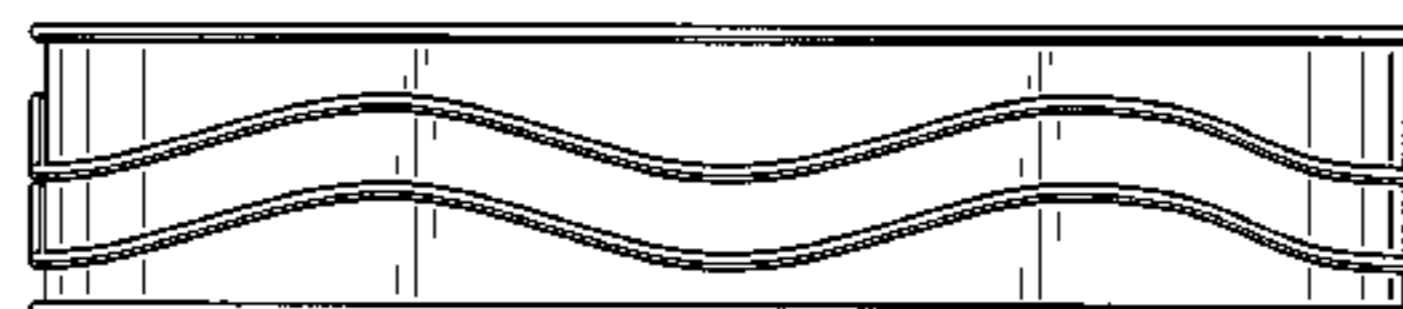
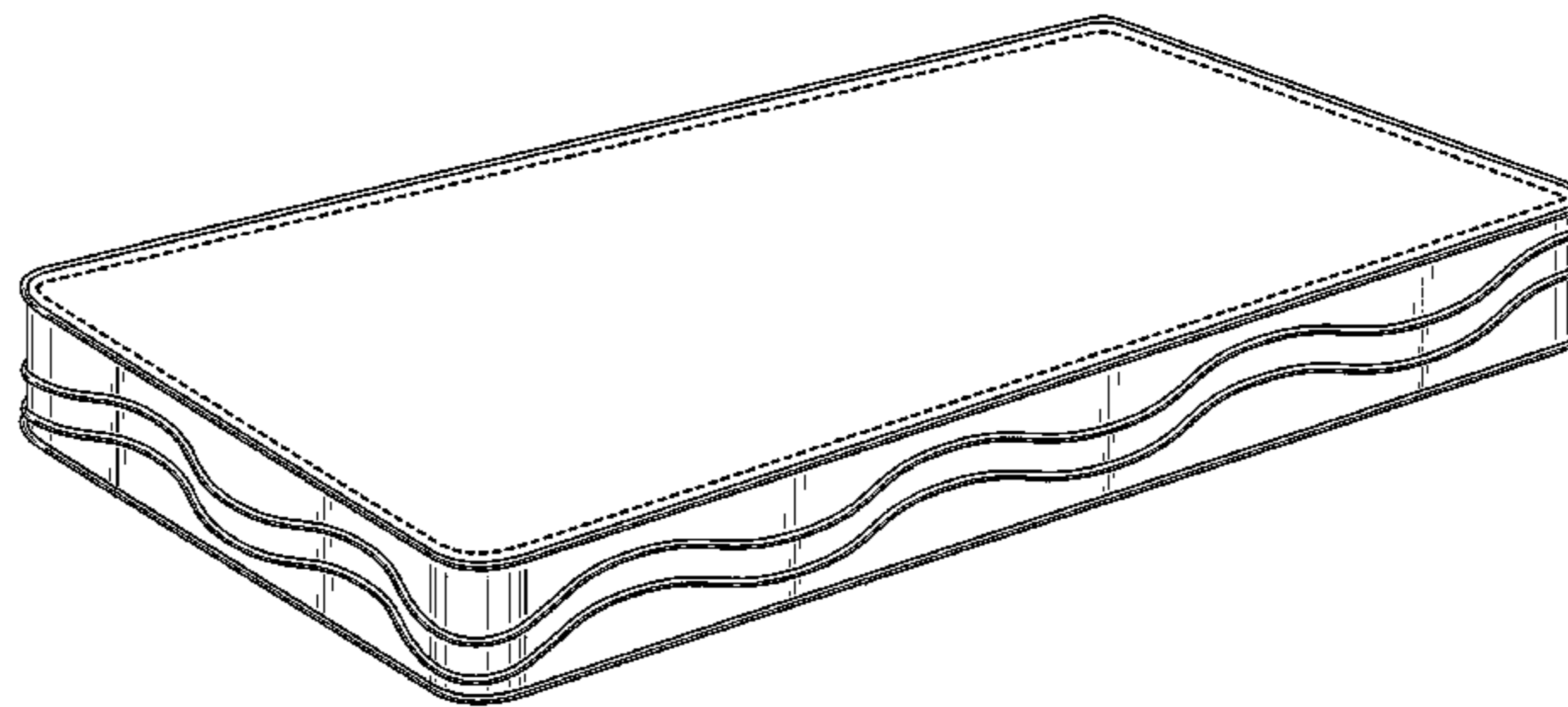

US D670,950 S

Page 2

U.S. PATENT DOCUMENTS

1,762,106	A *	6/1930	Pittoni	5/739					
D188,484	S *	8/1960	Koenigsberg	D6/605					
4,554,693	A	11/1985	Calloway						
5,195,196	A *	3/1993	Johenning et al.	5/677					
6,640,362	B1	11/2003	Kimball						
D551,011	S	9/2007	Van Patten						
D551,012	S	9/2007	Van Patten						
D552,397	S	10/2007	Van Patten						
D622,088	S	8/2010	Morrison						
					D622,531	S	8/2010	Morrison et al.	
					D633,322	S	3/2011	Morrison	
					D640,082	S	6/2011	Morrison	
					D642,413	S	8/2011	Rinehart	
					D651,443	S	1/2012	Wightman	
					D659,459	S	5/2012	Jung et al.	
					D662,751	S	7/2012	Morrison et al.	
					2011/0247144	A1 *	10/2011	Oh et al.	5/722

* cited by examiner

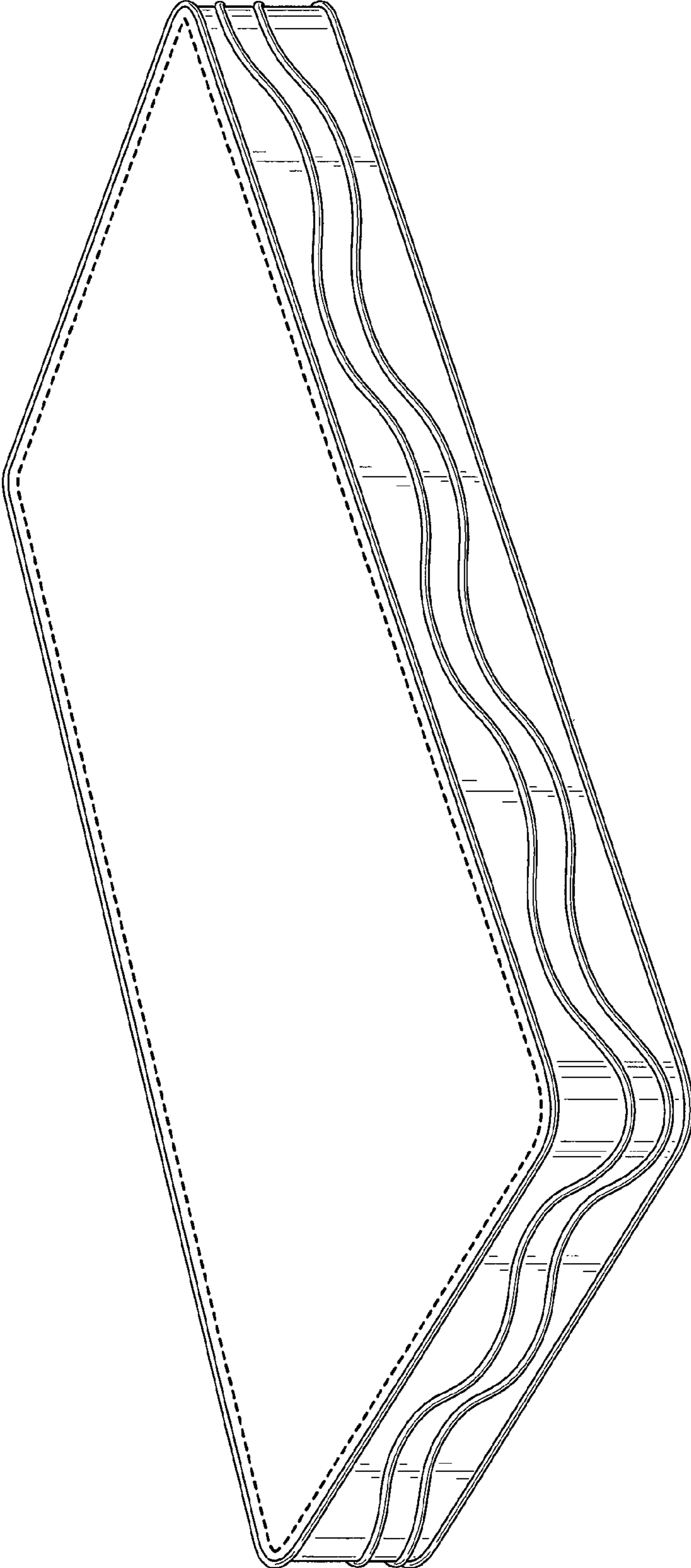

FIG. 1

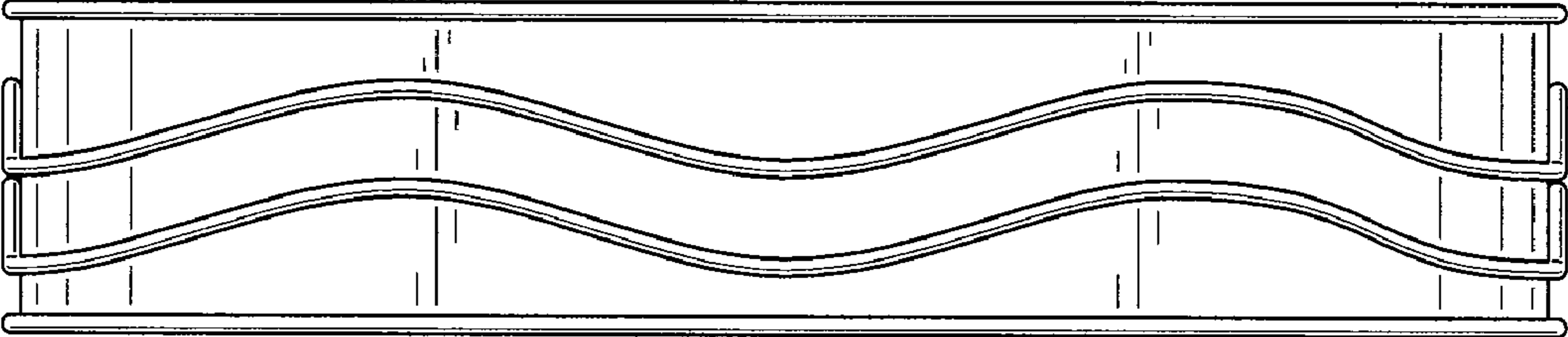

FIG. 2

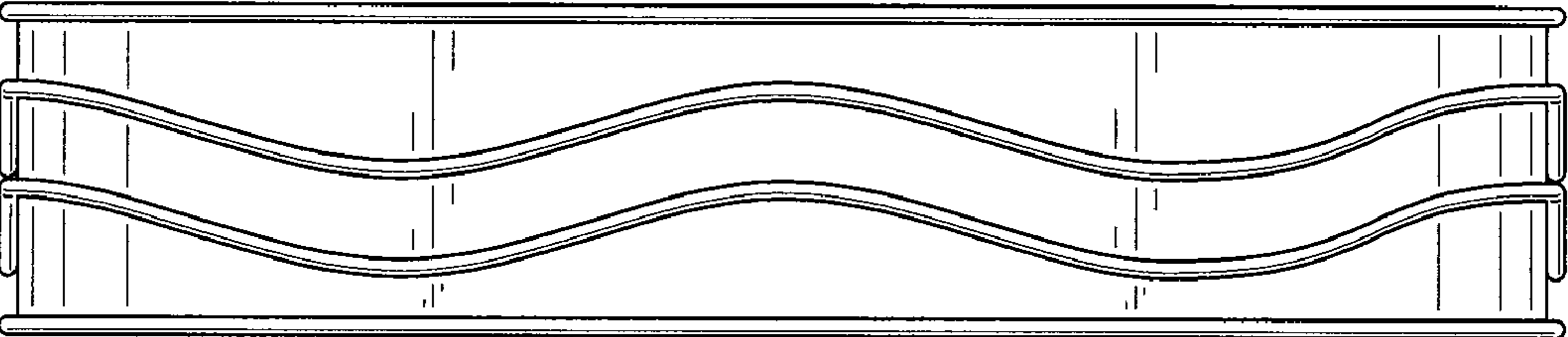

FIG. 3

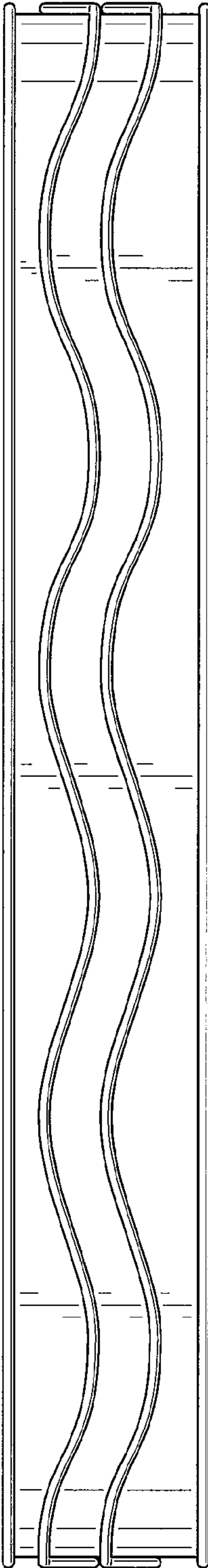

FIG. 4

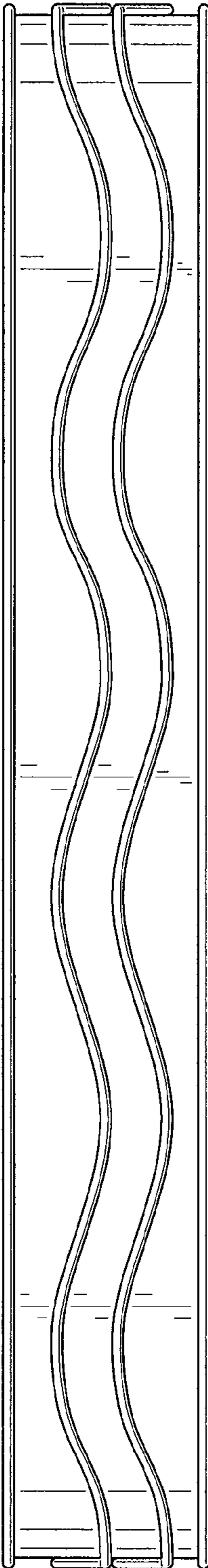

FIG. 5

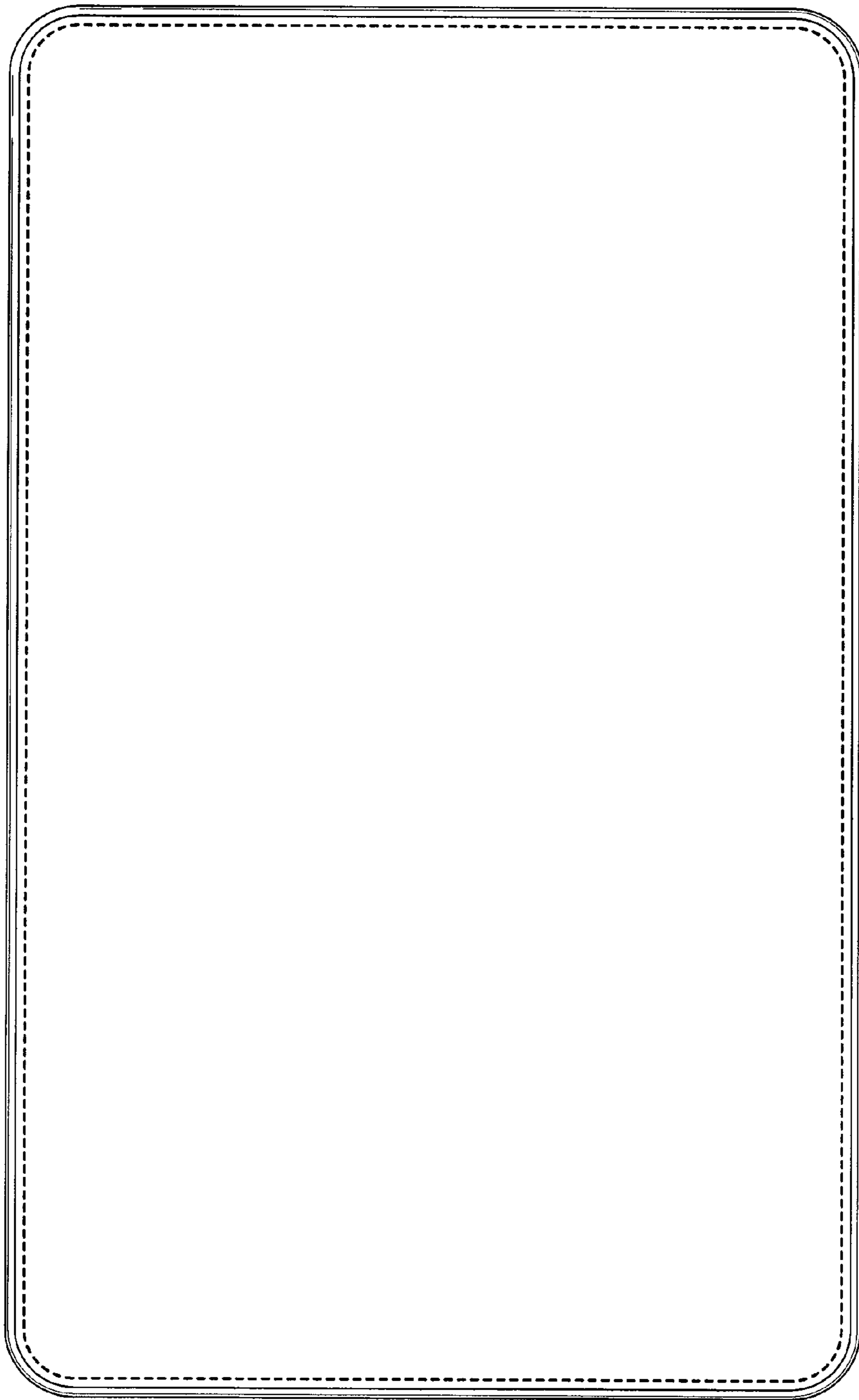

FIG. 6

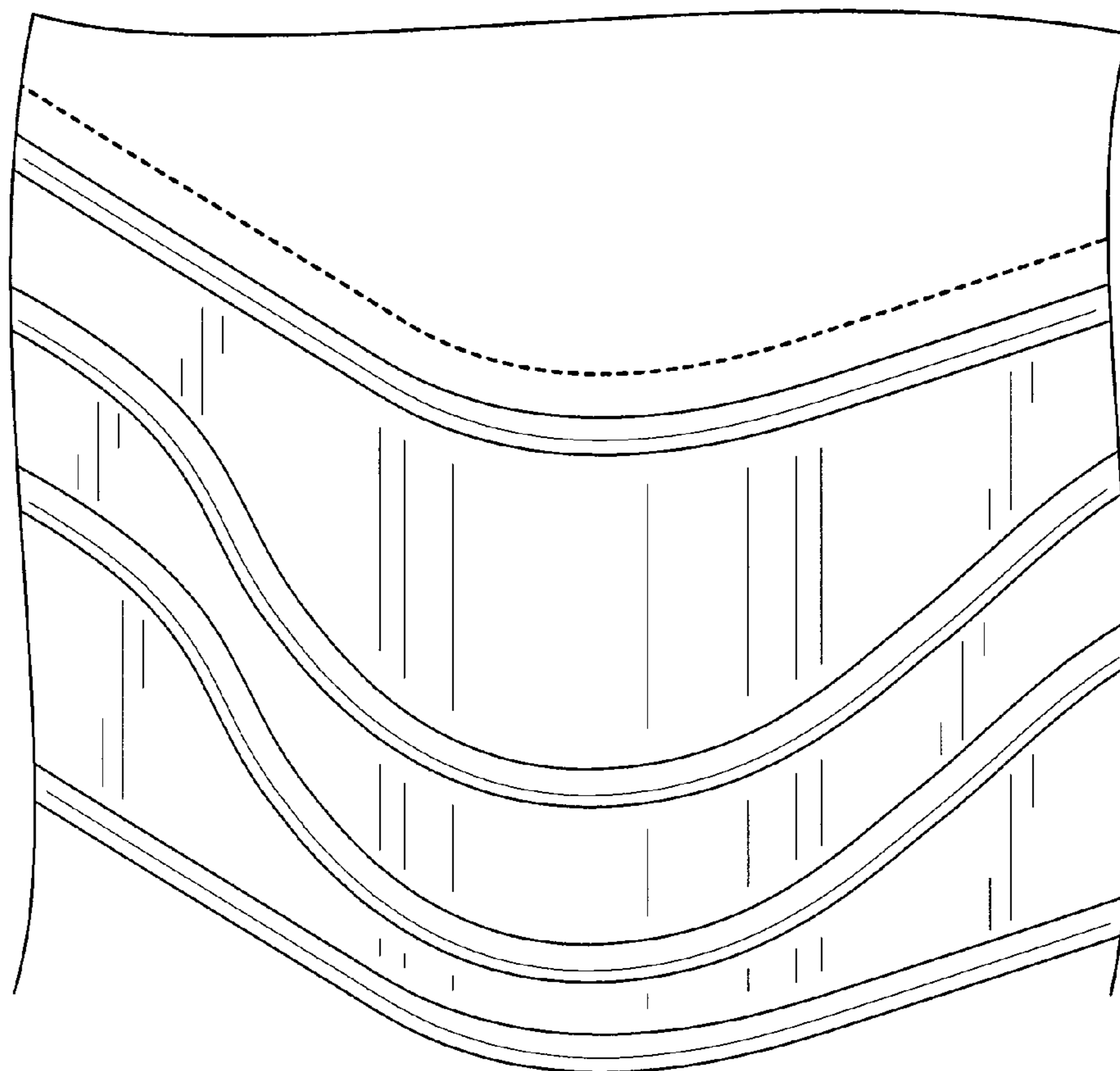

FIG. 7

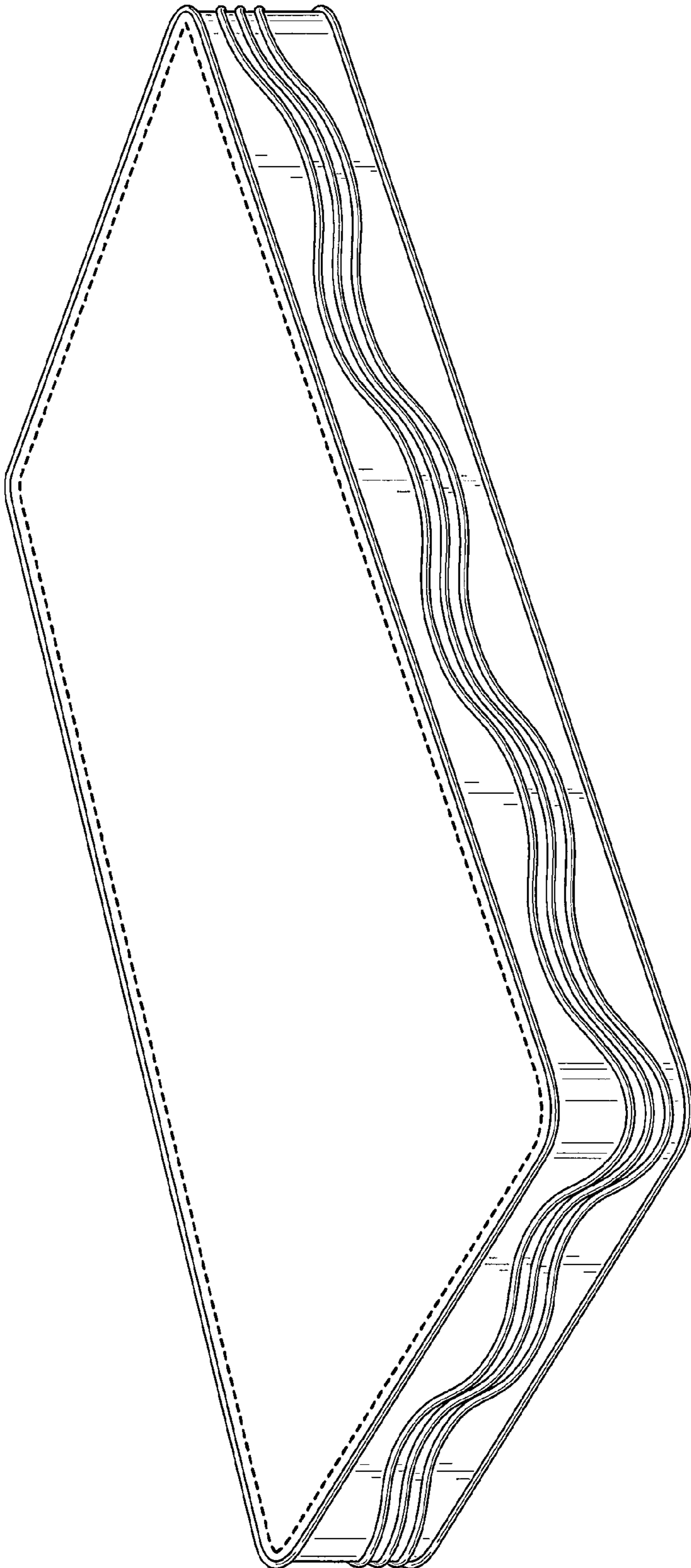

FIG. 8

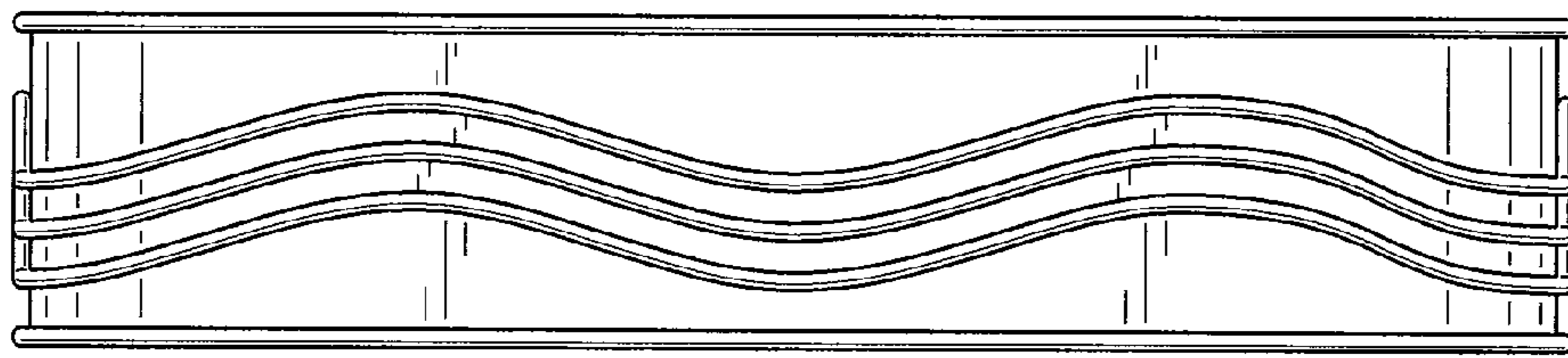

FIG. 9

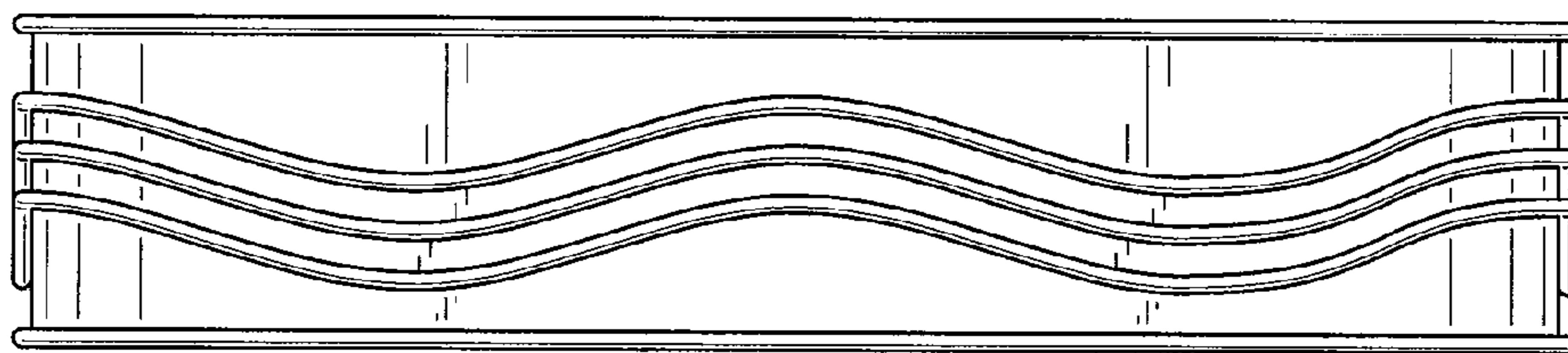

FIG. 10

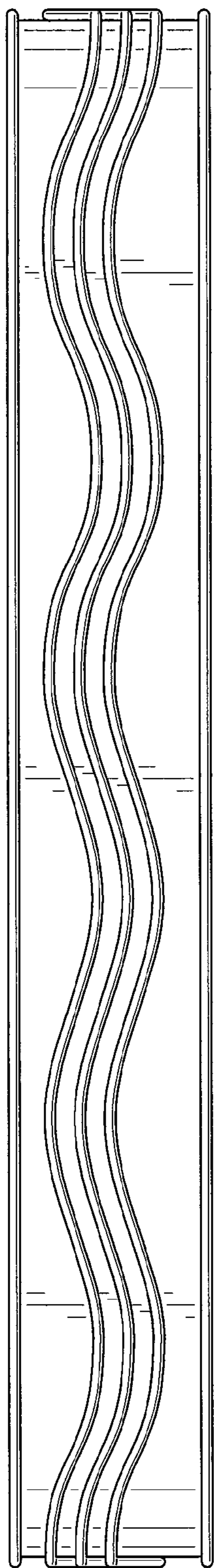

FIG. 11

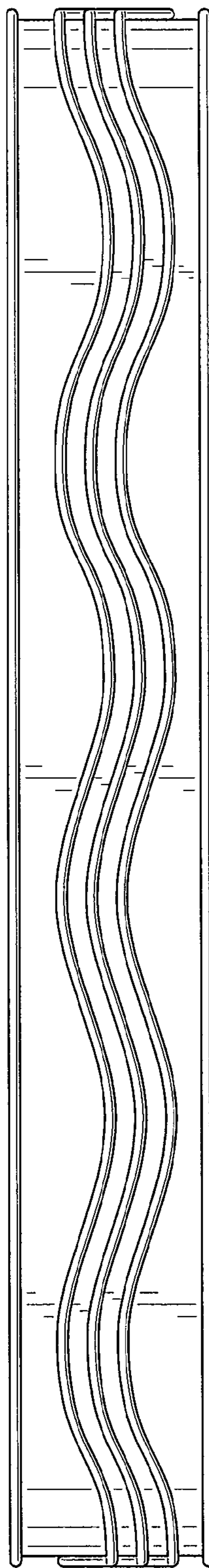

FIG. 12

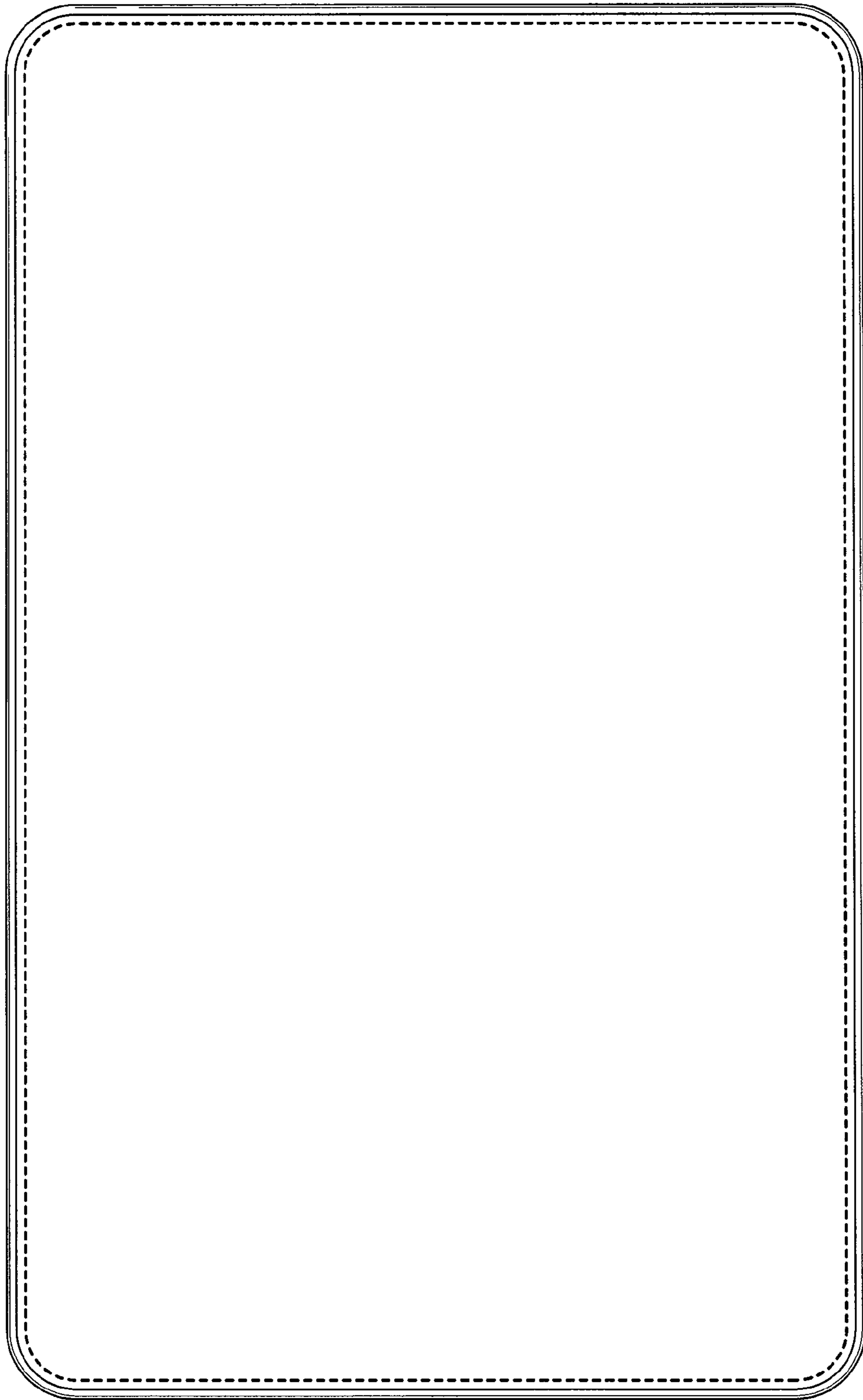

FIG. 13

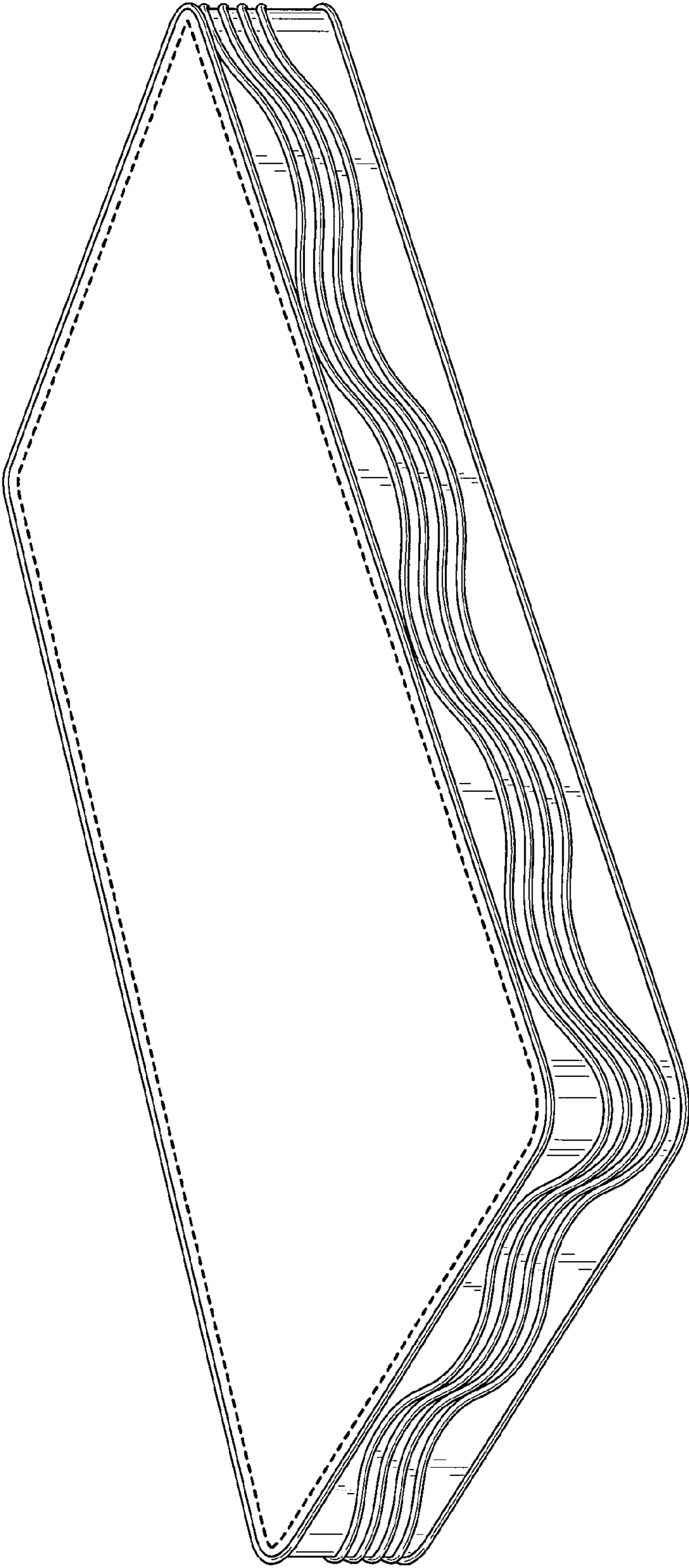

FIG. 14

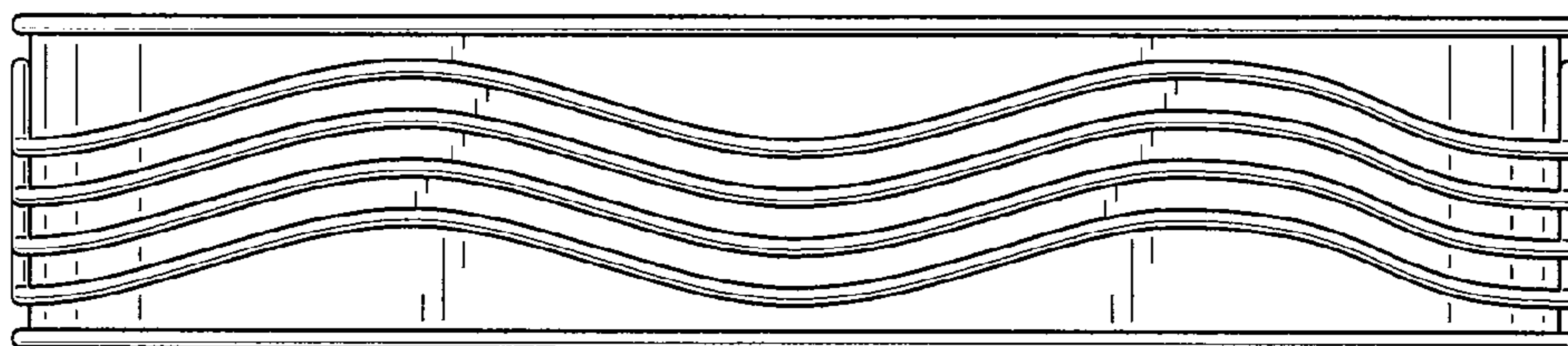

FIG. 15

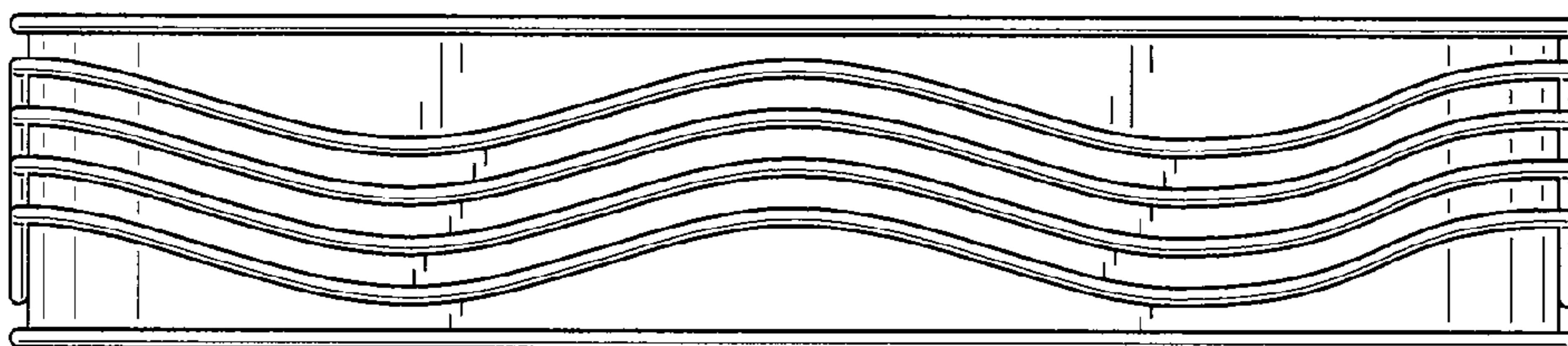

FIG. 16

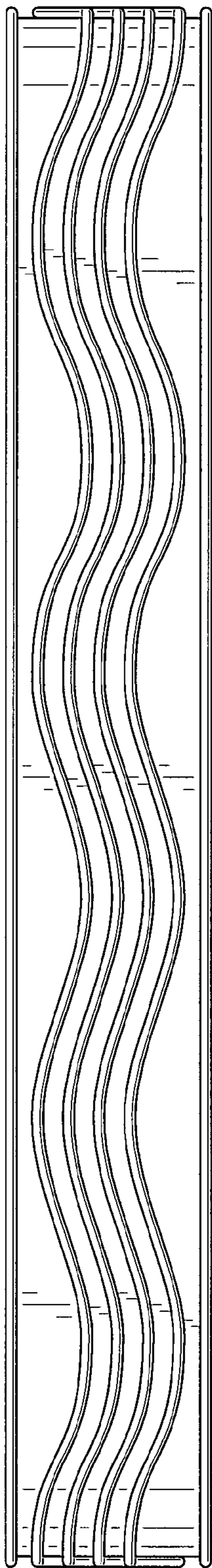

FIG. 17

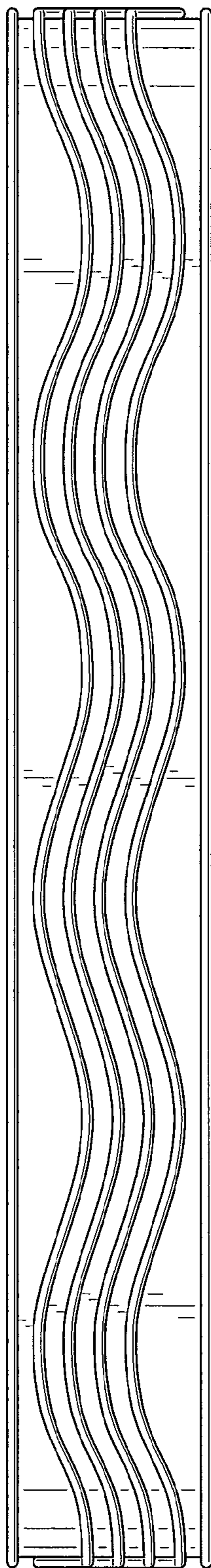

FIG. 18

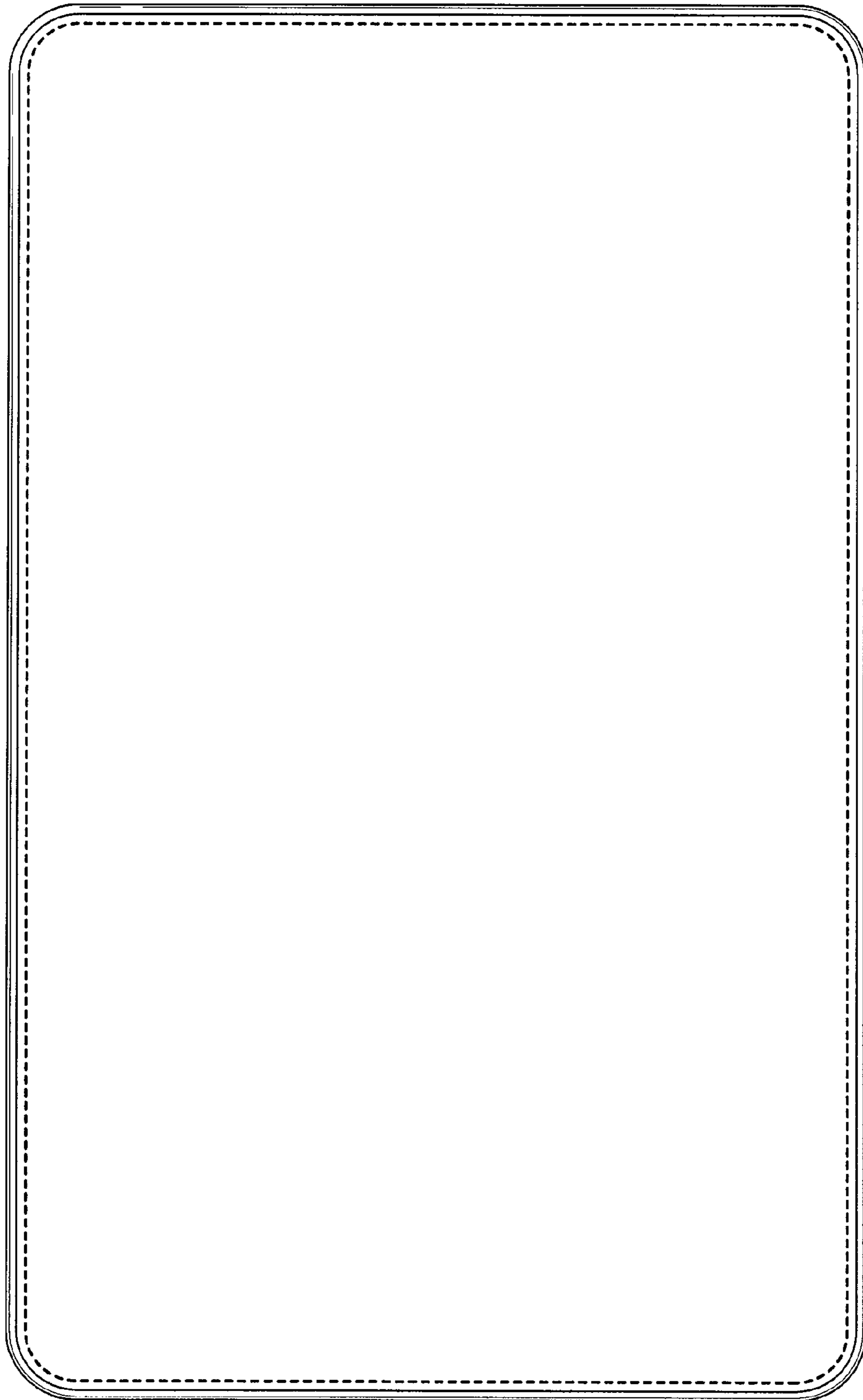

FIG. 19