

US00D670689S

(12) **United States Design Patent**
Wang

(10) **Patent No.:** **US D670,689 S**

(45) **Date of Patent:** **** Nov. 13, 2012**

(54) **MOBILE DEVICE CASE**

(76) Inventor: **Wen Fee Wang**, Las Vegas, NV (US)

(**) Term: **14 Years**

(21) Appl. No.: **29/374,465**

(22) Filed: **Aug. 17, 2011**

(51) **LOC (9) Cl.** **14-03**

(52) **U.S. Cl.** **D14/250**

(58) **Field of Classification Search** D14/250,
D14/251, 253, 240, 217, 496, 440, 203.3,
D14/203.4, 203.5, 203.8; D3/218, 215, 201;
220/4.02; 248/309.1; 361/679.56; 379/426,
379/433.11, 455; 455/575.1, 575.8; 190/100;
206/305, 320

See application file for complete search history.

(56) **References Cited**

U.S. PATENT DOCUMENTS

D574,819 S *	8/2008	Andre et al.	D3/269
D597,089 S *	7/2009	Khan et al.	D14/250
D615,536 S *	5/2010	Richardson et al.	D14/250
D623,640 S *	9/2010	Freeman	D14/250
D626,540 S *	11/2010	Brown et al.	D14/250

D634,741 S *	3/2011	Richardson et al.	D14/250
D644,635 S *	9/2011	Richardson et al.	D14/250
D653,202 S *	1/2012	Hasbrook et al.	D13/103
D663,295 S *	7/2012	Fahrendorff et al.	D14/250
2009/0186264 A1 *	7/2009	Huang	429/96

* cited by examiner

Primary Examiner — Cynthia Underwood

(57) **CLAIM**

The ornamental design for a mobile device case, as shown and described.

DESCRIPTION

FIG. 1 is a perspective view of a mobile device case showing my new design;
 FIG. 2 is an exploded view;
 FIG. 3 is another exploded view;
 FIG. 4 is a top view;
 FIG. 5 is a bottom view;
 FIG. 6 is a left side view;
 FIG. 7 is a right side view;
 FIG. 8 is a front view; and,
 FIG. 9 is a rear side view.

1 Claim, 9 Drawing Sheets

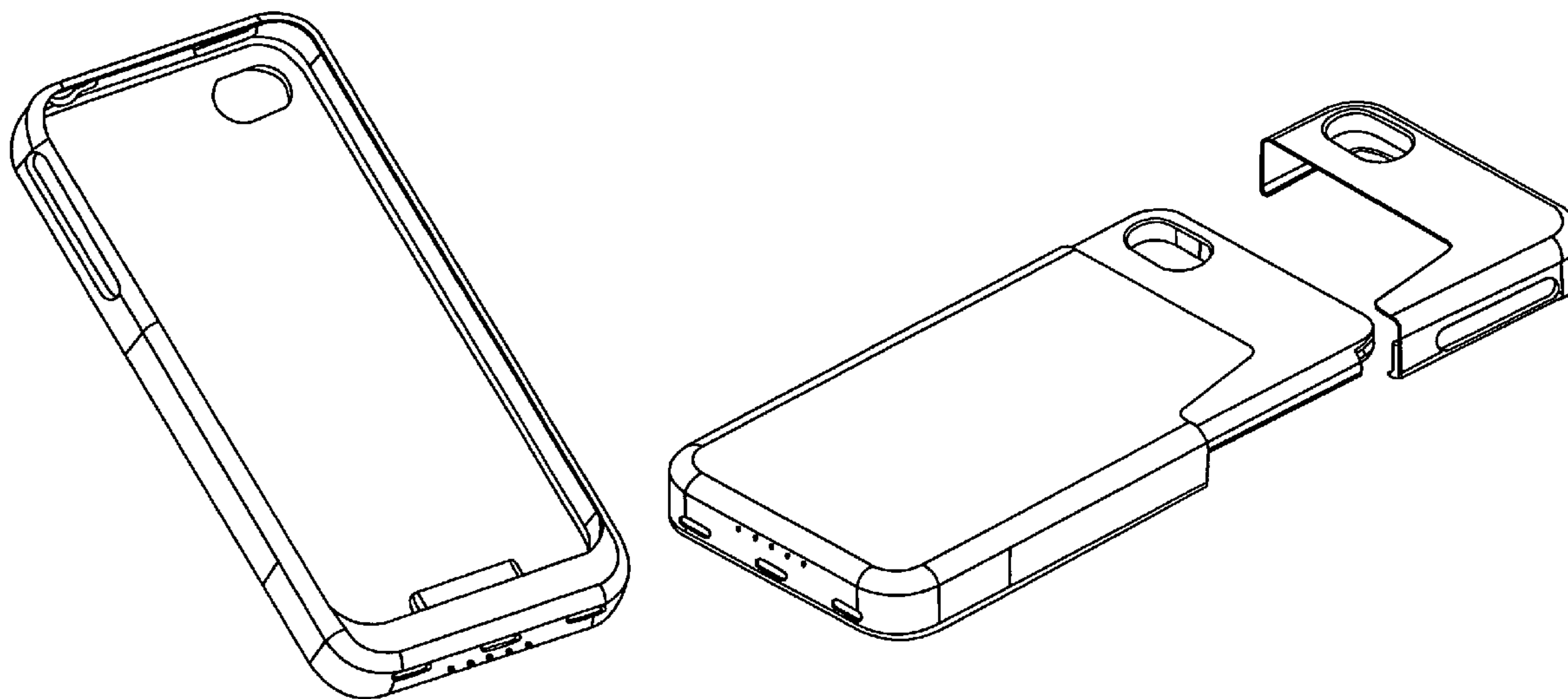

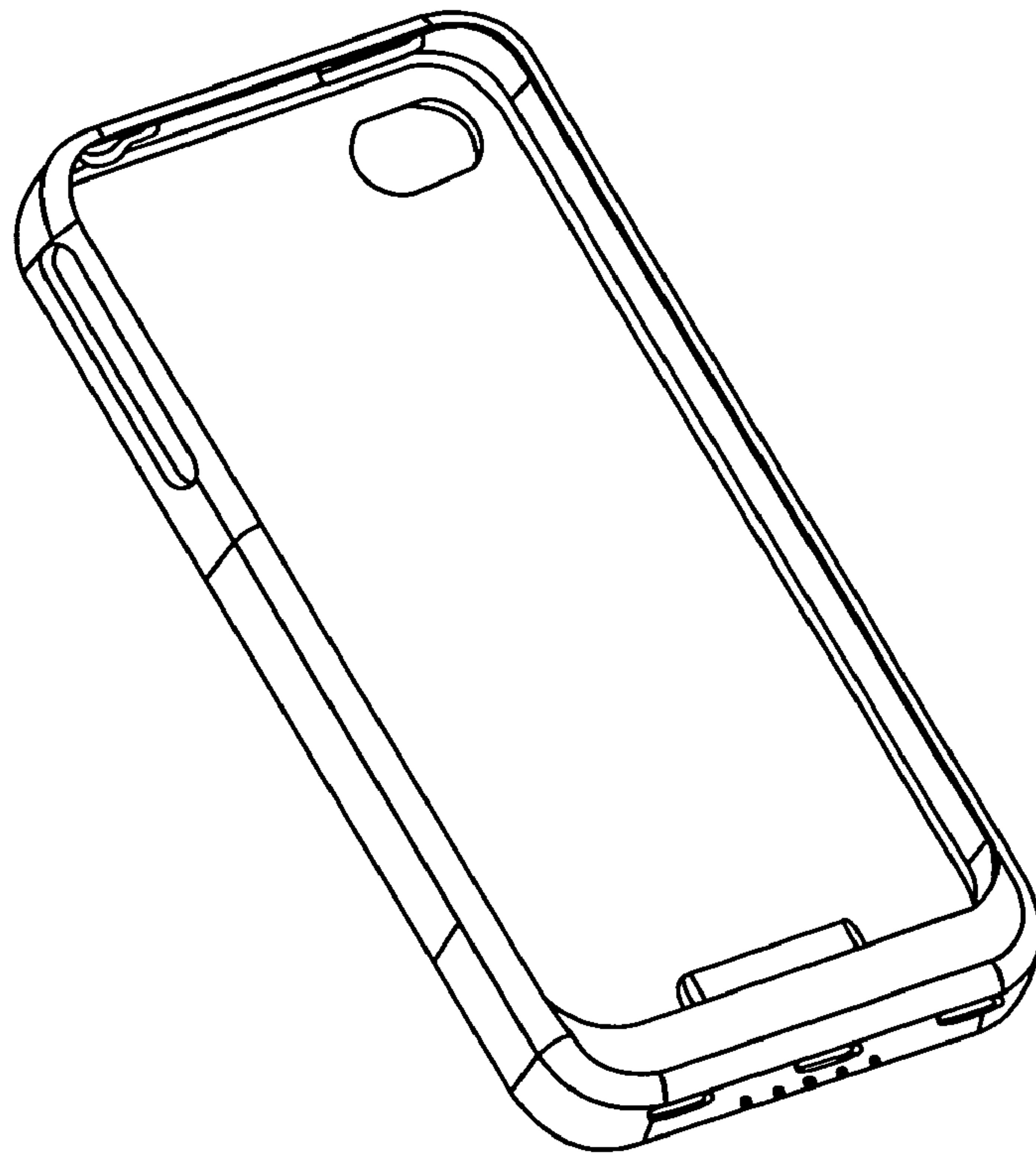

FIG. 1

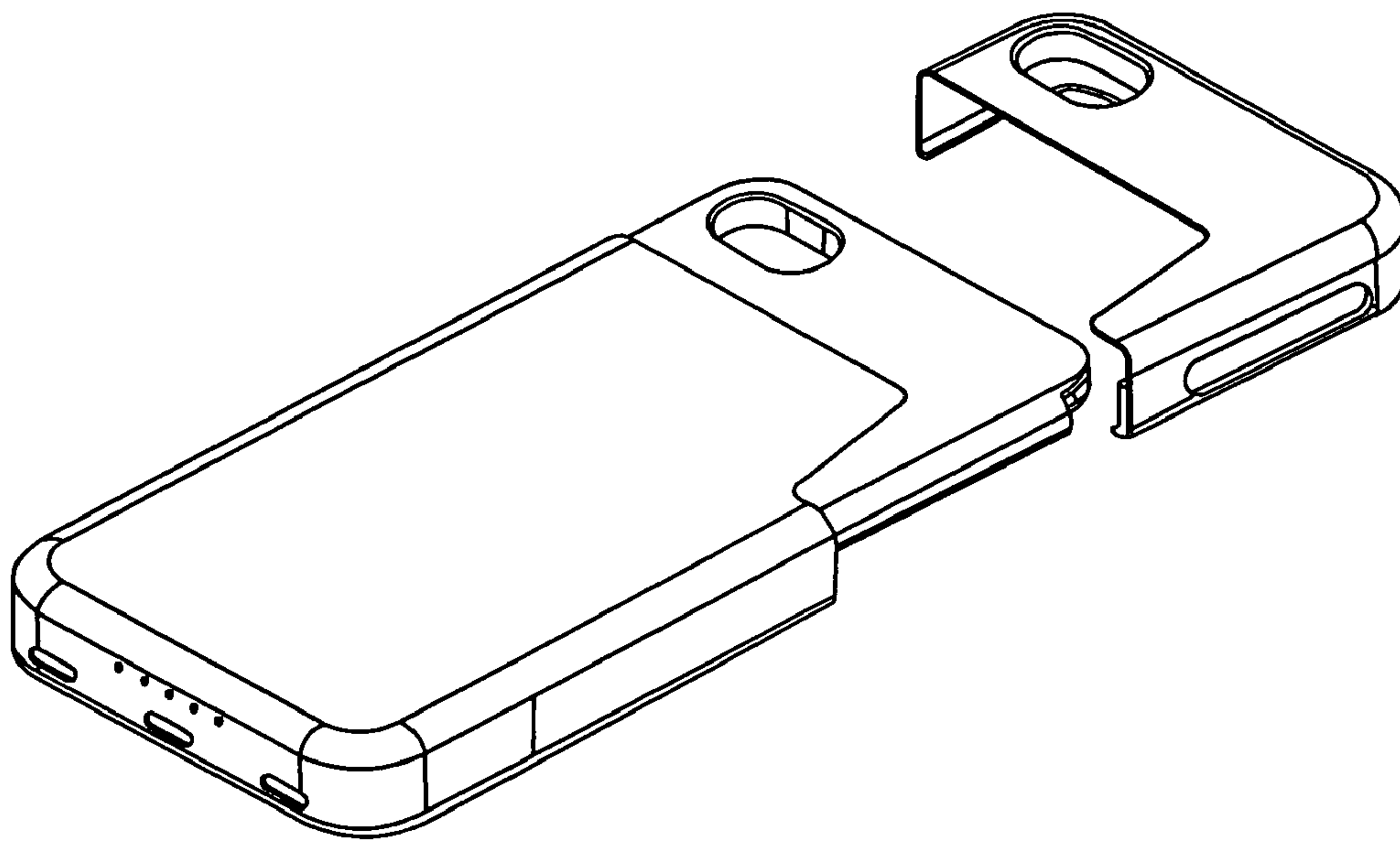

FIG.2

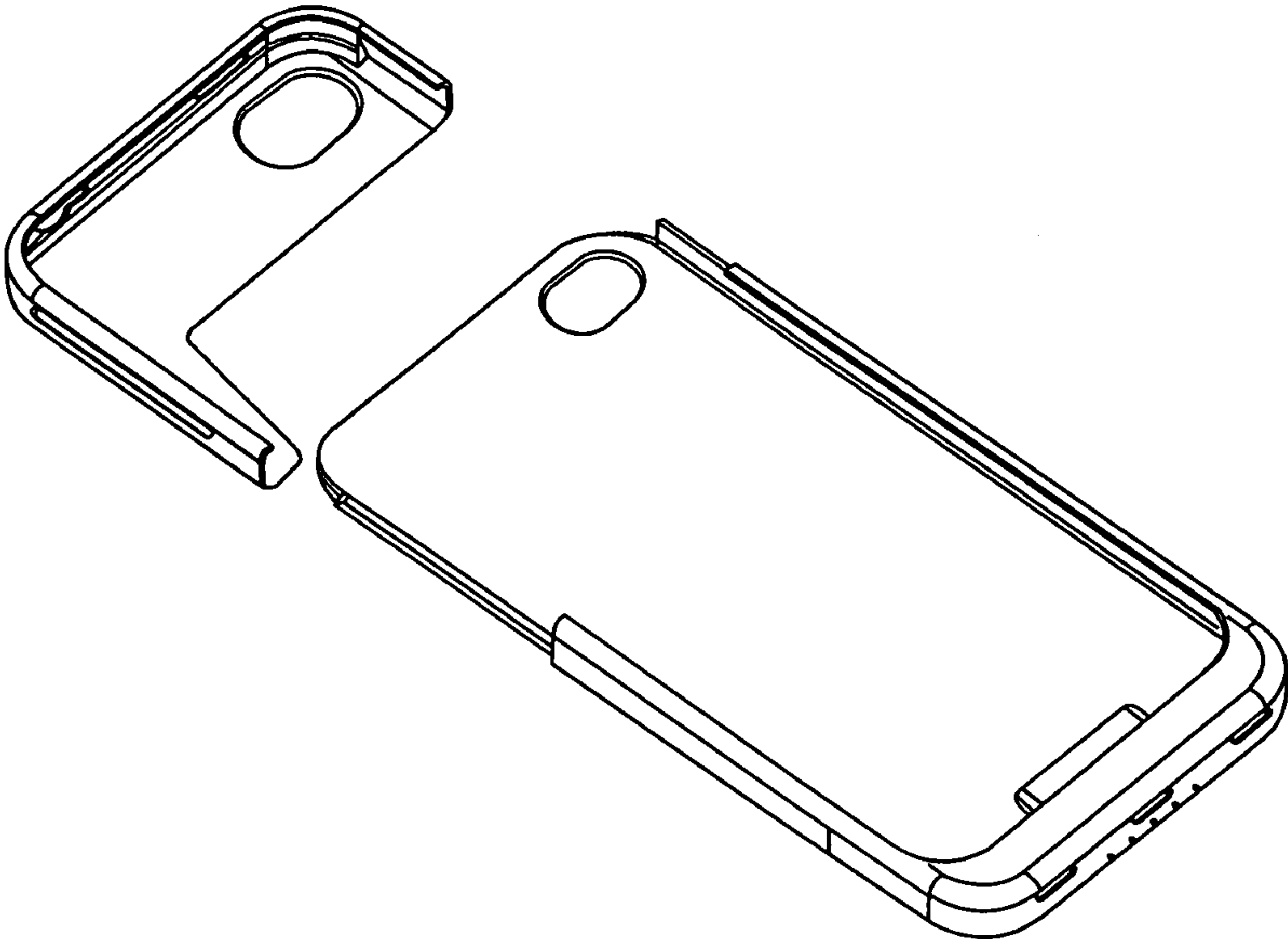

FIG. 3

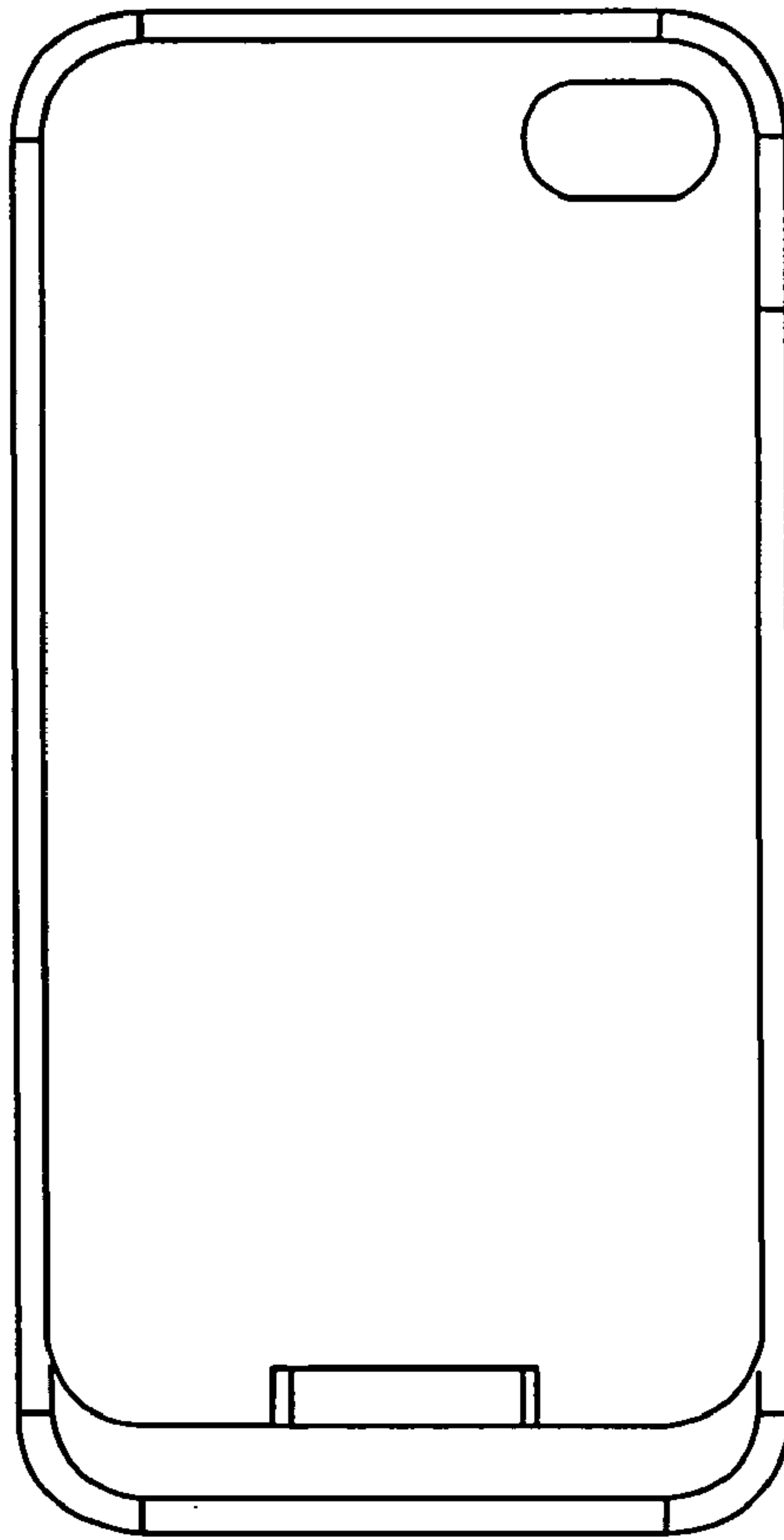

FIG. 4

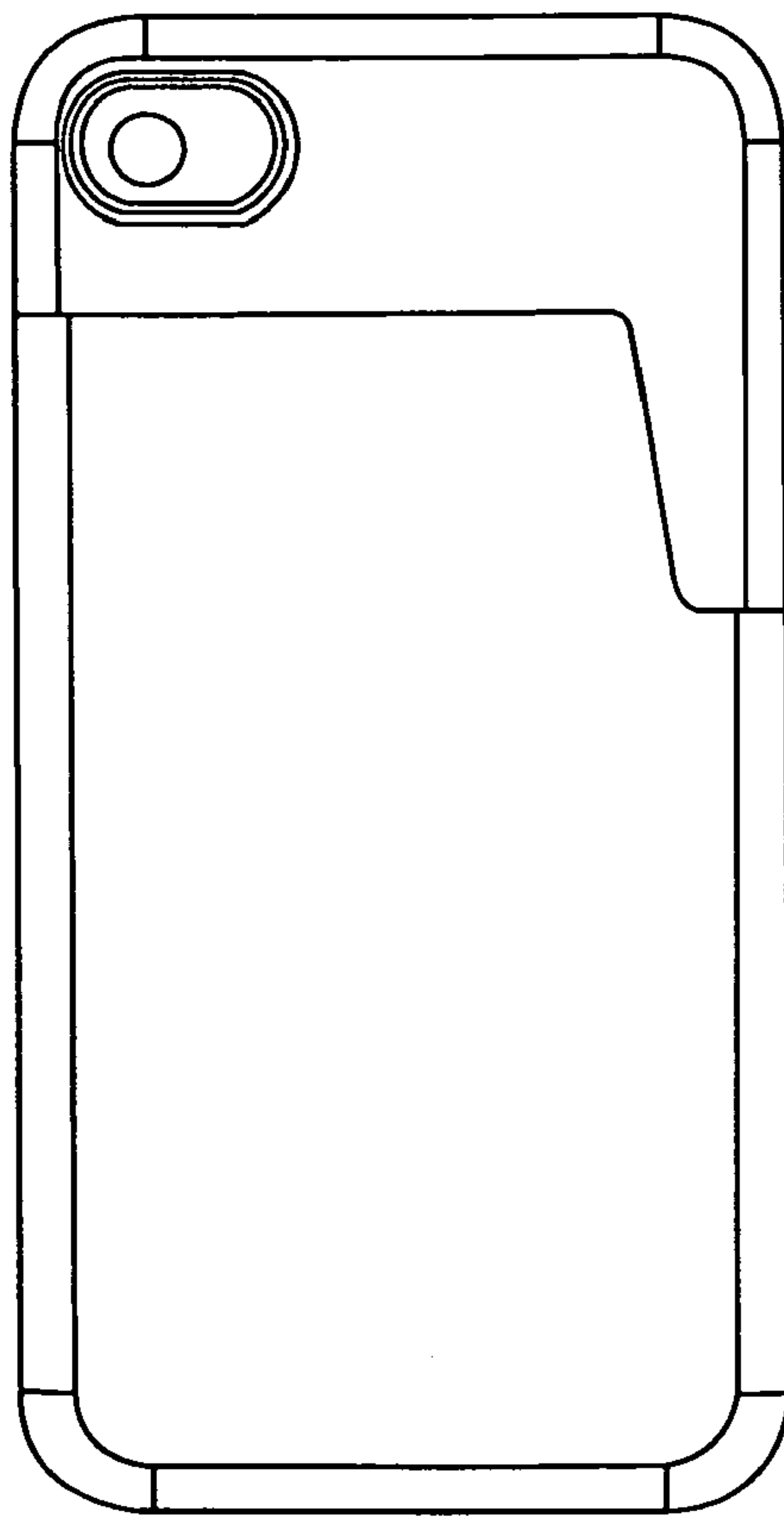

FIG. 5

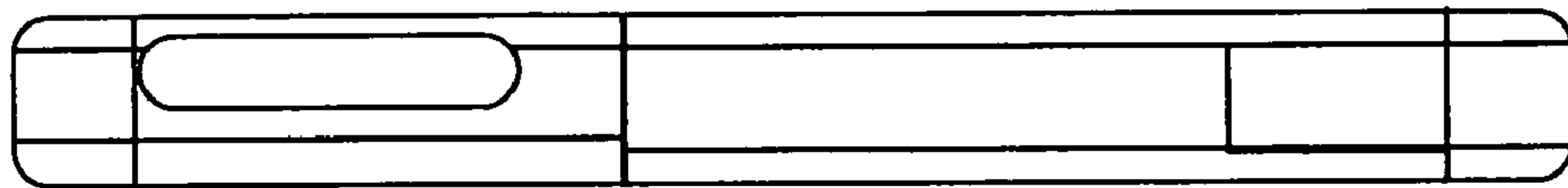

FIG. 6

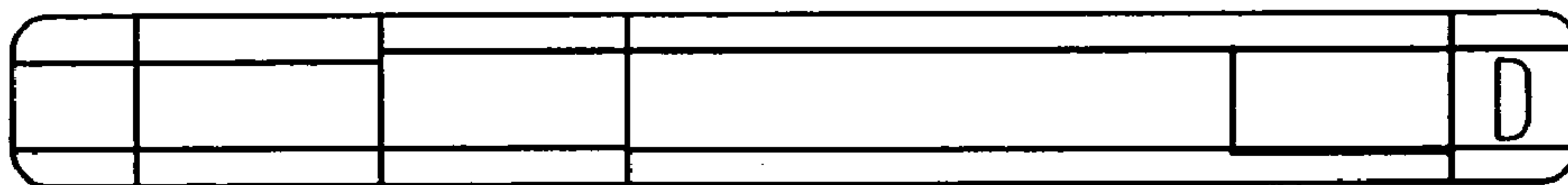

FIG. 7

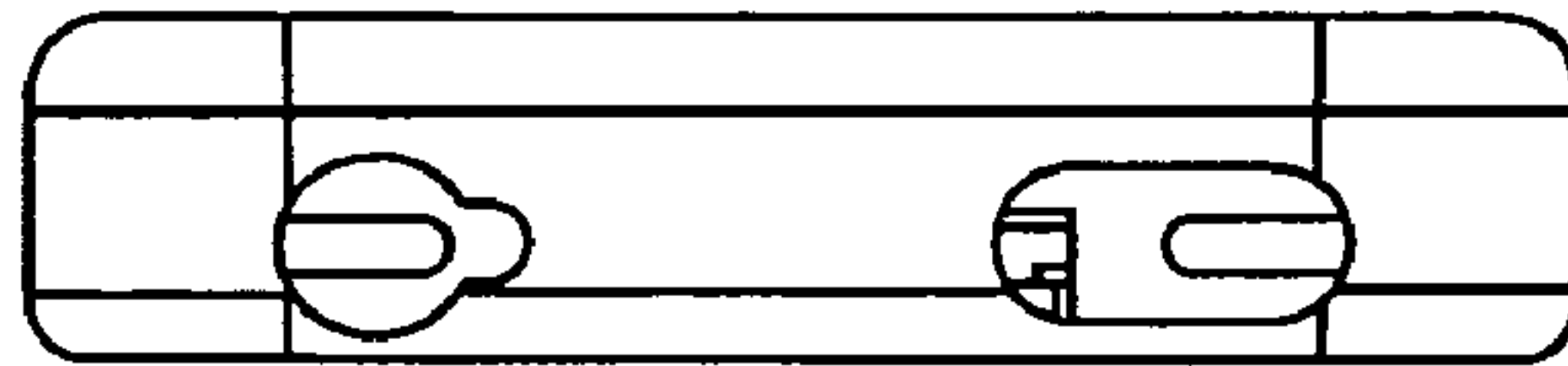

FIG. 8

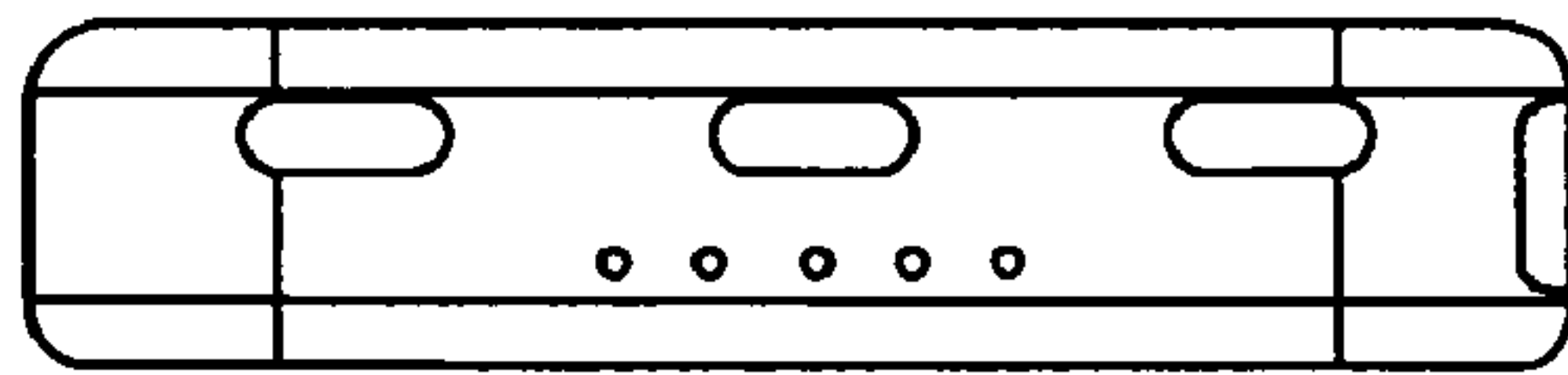

FIG. 9