



US00D670660S

(12) **United States Design Patent**  
**Cook**

(10) **Patent No.:** **US D670,660 S**

(45) **Date of Patent:** **\*\* Nov. 13, 2012**

(54) **REMOTE CONTROL**

(75) Inventor: **Jeff S. Cook**, Dove Canyon, CA (US)

(73) Assignee: **Inseat Solutions, LLC**, Santa Fe Springs, CA (US)

(\*\*) Term: **14 Years**

(21) Appl. No.: **29/412,282**

(22) Filed: **Feb. 1, 2012**

**Related U.S. Application Data**

(62) Division of application No. 29/390,579, filed on Apr. 27, 2011, now Pat. No. Des. 656,105.

(51) **LOC (9) Cl.** ..... **14-03**

(52) **U.S. Cl.** ..... **D13/168**

(58) **Field of Classification Search** ..... D13/168;  
D10/104.1, 106.1; D14/218; D21/324; 315/158,  
315/295; 340/4.3, 4.42, 12.22, 12.23, 12.24,  
340/12.29, 12.3, 13.2, 13.21, 13.24; 341/176;  
345/169; 348/734; 455/352; 463/39; 700/17,  
700/65, 83

See application file for complete search history.

(56) **References Cited**

**U.S. PATENT DOCUMENTS**

6,039,702	A *	3/2000	Cutler et al.	601/15
D435,834	S	1/2001	Picozza et al.	
D467,004	S *	12/2002	Gerth	D24/200
D509,480	S	9/2005	Li	
D510,536	S	10/2005	Li	
D526,967	S	8/2006	Hoehn et al.	
7,142,256	B2	11/2006	Stoner et al.	
7,218,249	B2	5/2007	Chadha	
D546,818	S	7/2007	Gautier	
D563,907	S	3/2008	Badarello	
D572,206	S	7/2008	Ikeda et al.	
D600,654	S	9/2009	Liao	
D612,839	S	3/2010	Kato	
7,884,703	B2	2/2011	Sowada et al.	

D656,104	S *	3/2012	Cook	D13/168
D656,105	S *	3/2012	Cook	D13/168
D662,066	S *	6/2012	Seidl et al.	D13/168

\* cited by examiner

*Primary Examiner* — Selina Sikder

(74) *Attorney, Agent, or Firm* — Fox Rothschild LLP

(57) **CLAIM**

The ornamental design for remote control, as shown and described.

**DESCRIPTION**

FIG. 1 is a perspective view of a first embodiment of a remote control according to the new design;

FIG. 2 is a top plan view thereof;

FIG. 3 is a right side view thereof;

FIG. 4 is a bottom plan view thereof;

FIG. 5 is a rear view thereof;

FIG. 6 is a front view thereof;

FIG. 7 is a perspective view according to a second embodiment of the new design;

FIG. 8 is a top plan view thereof;

FIG. 9 is a right side view thereof;

FIG. 10 is a bottom plan view thereof;

FIG. 11 is a rear view thereof;

FIG. 12 is a front view thereof;

FIG. 13 is a perspective view of a third embodiment of the new design;

FIG. 14 is a top plan view thereof;

FIG. 15 is a right side view thereof;

FIG. 16 is a bottom plan view thereof;

FIG. 17 is a rear view thereof;

FIG. 18 is a front view thereof;

FIG. 19 is a perspective view of a fourth embodiment of the new design;

FIG. 20 is a top plan view thereof;

FIG. 21 is a right side view thereof;

FIG. 22 is a bottom plan view thereof;

FIG. 23 is a rear view thereof; and,

FIG. 24 is a front view thereof.

**1 Claim, 4 Drawing Sheets**

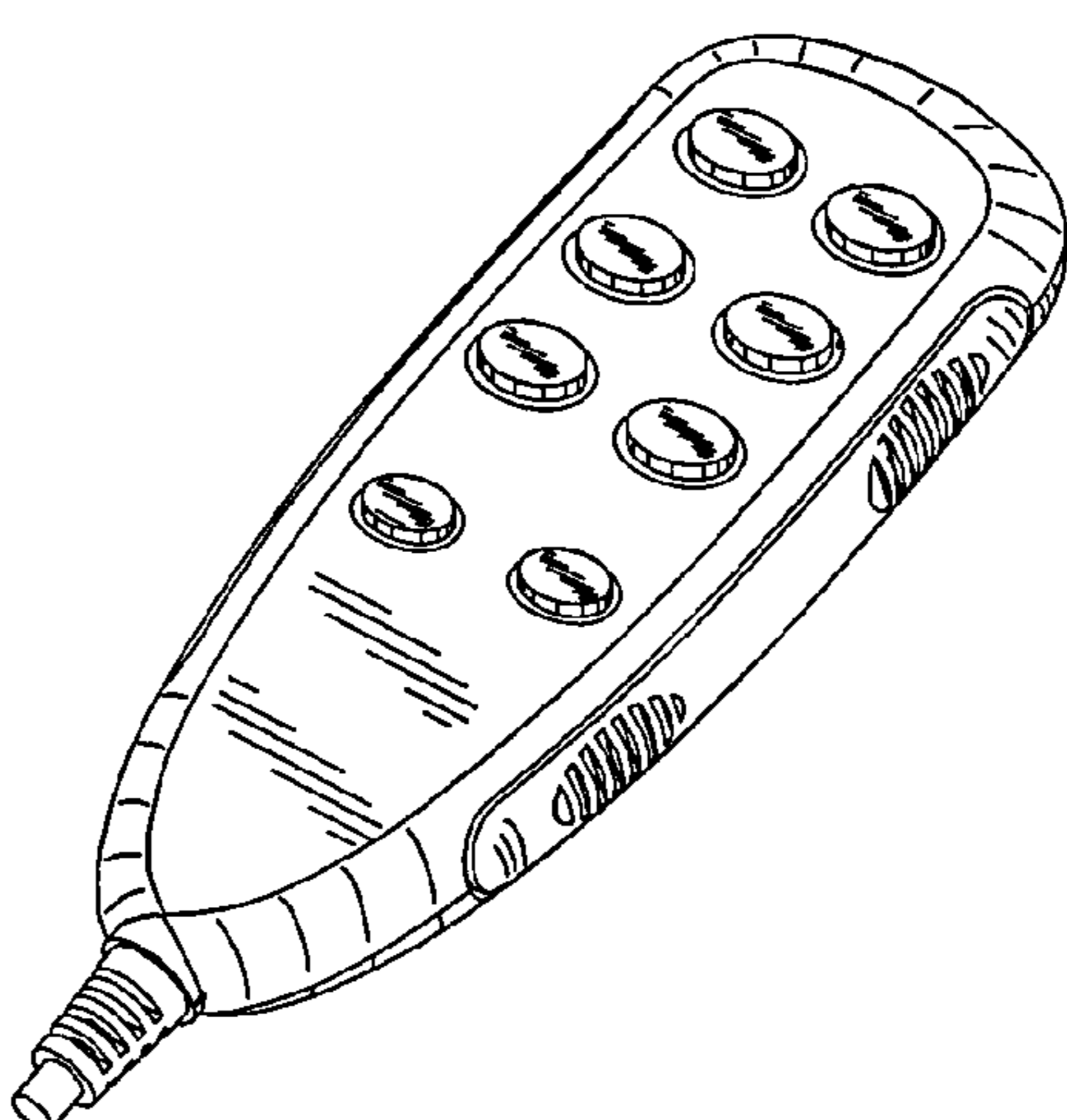
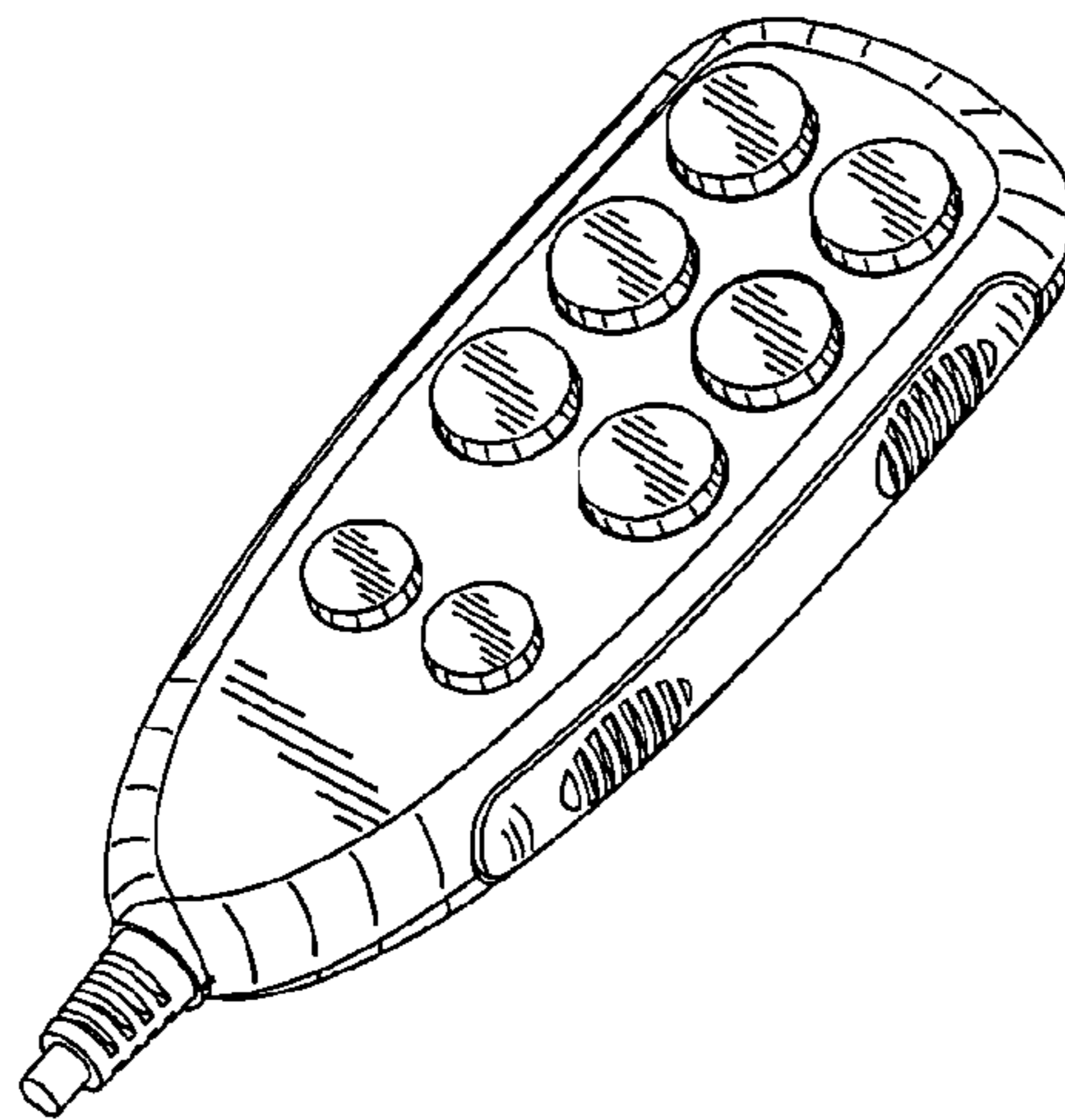

FIG. 1

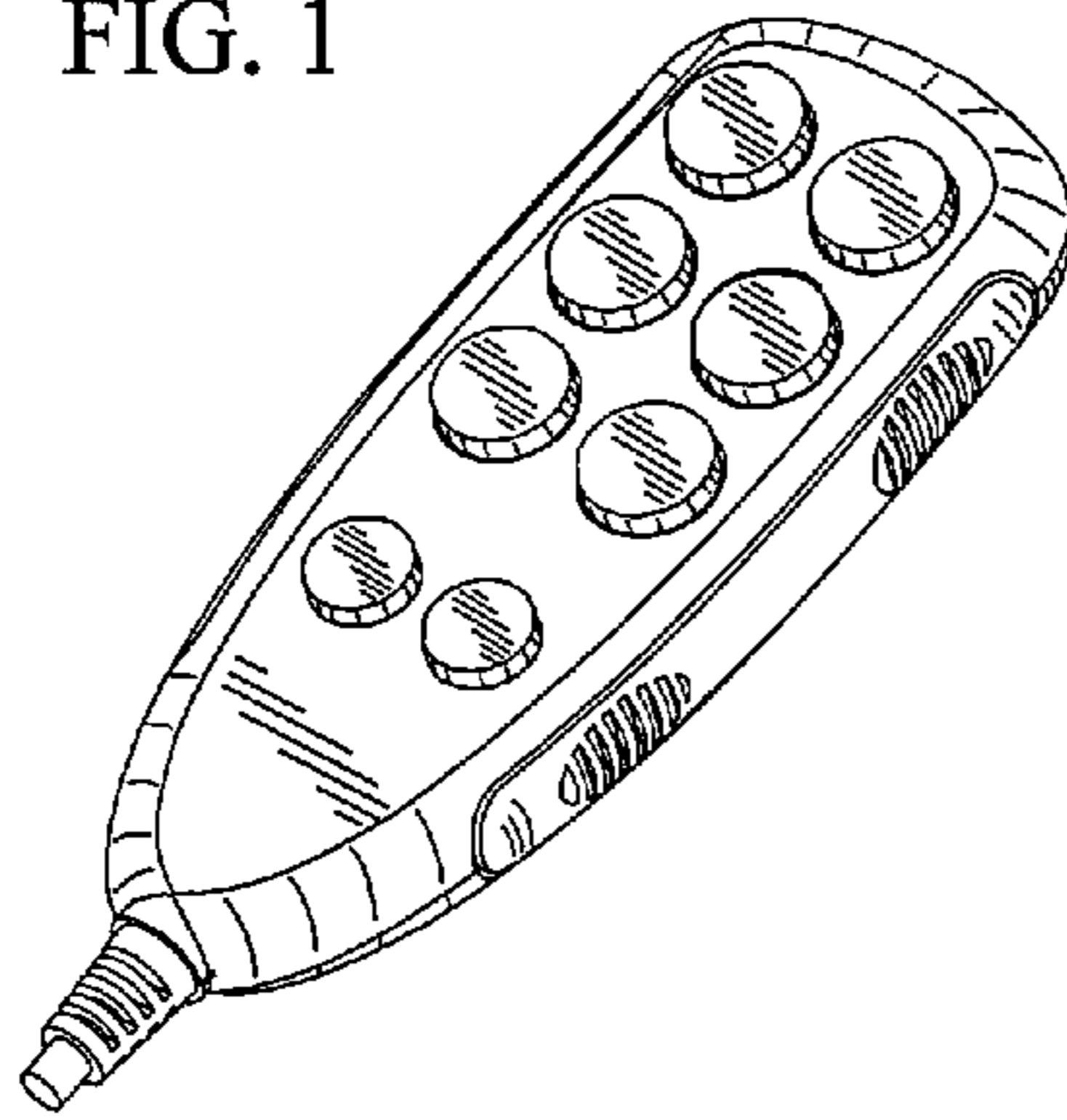

FIG. 2

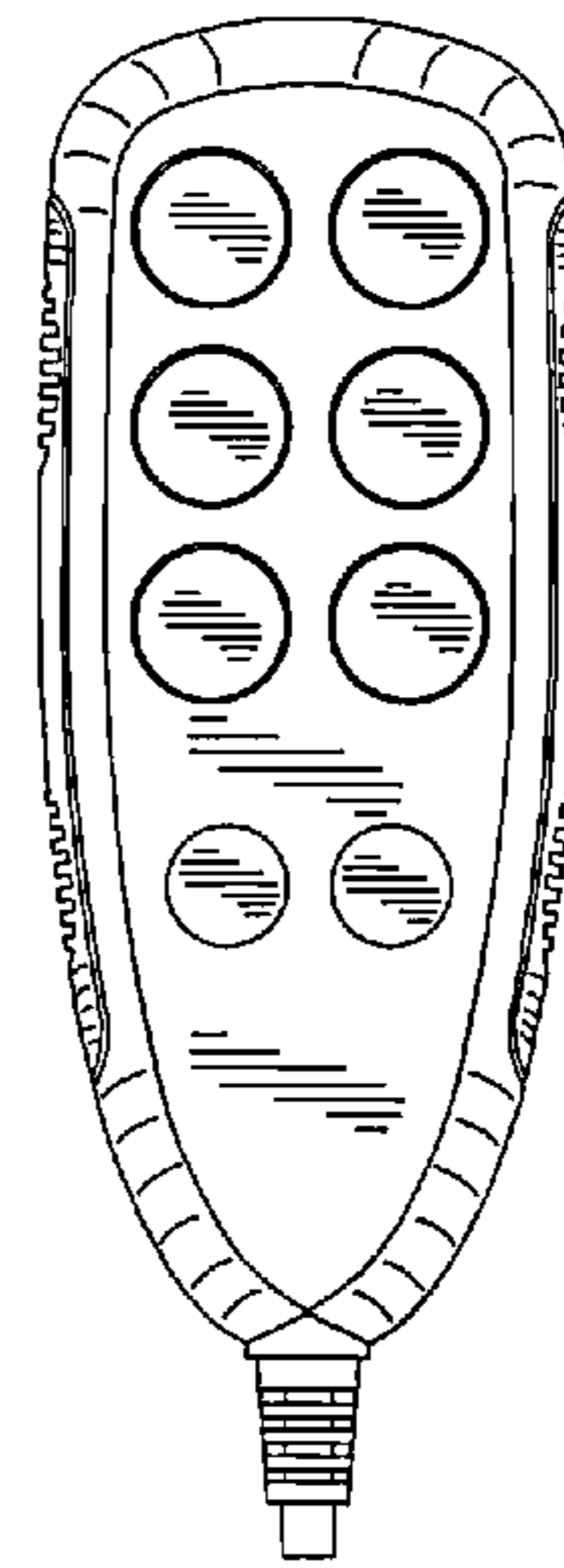

FIG. 3

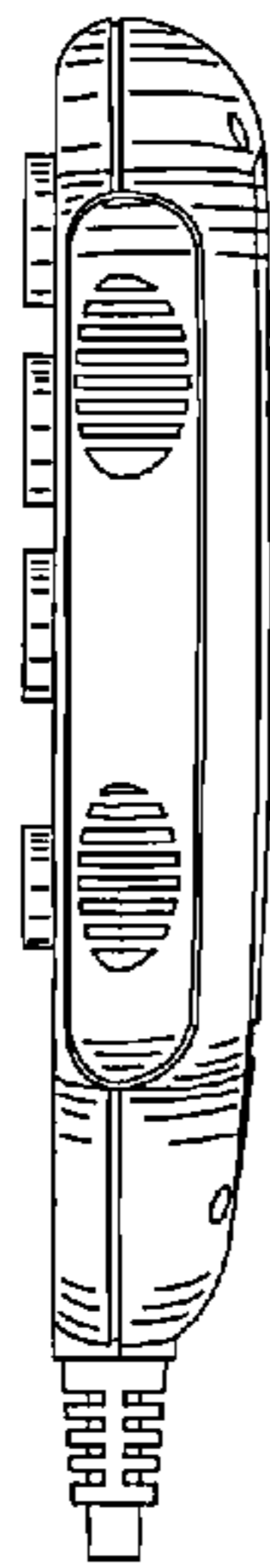

FIG. 4

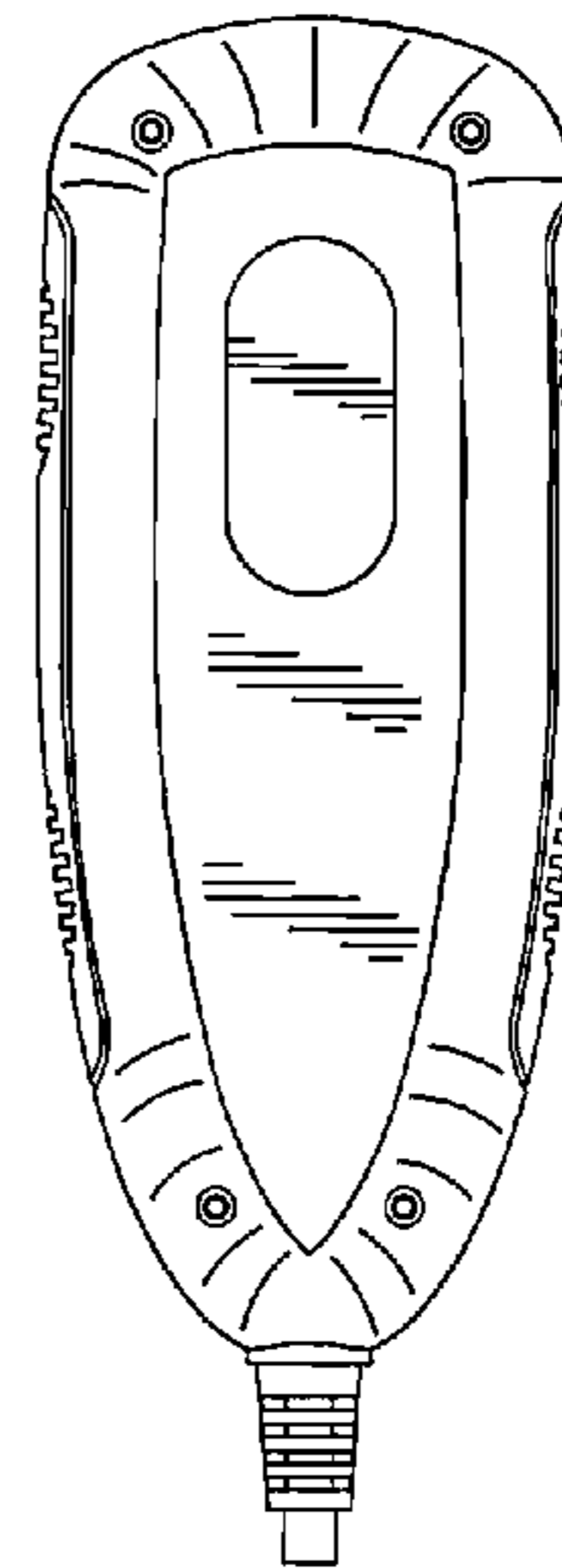

FIG. 5

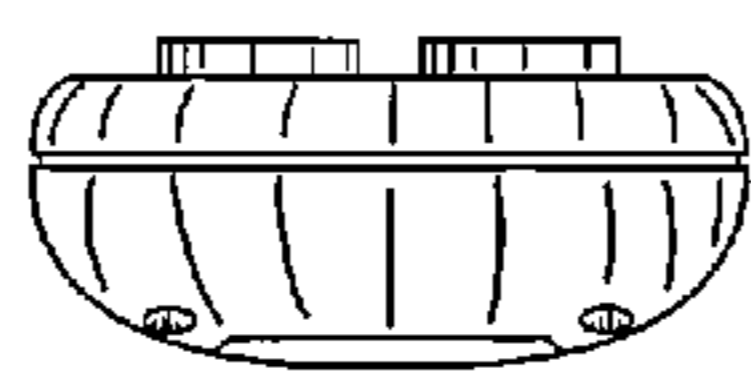
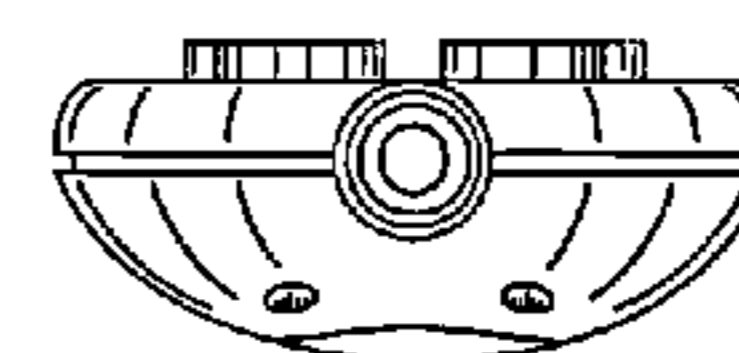

FIG. 6



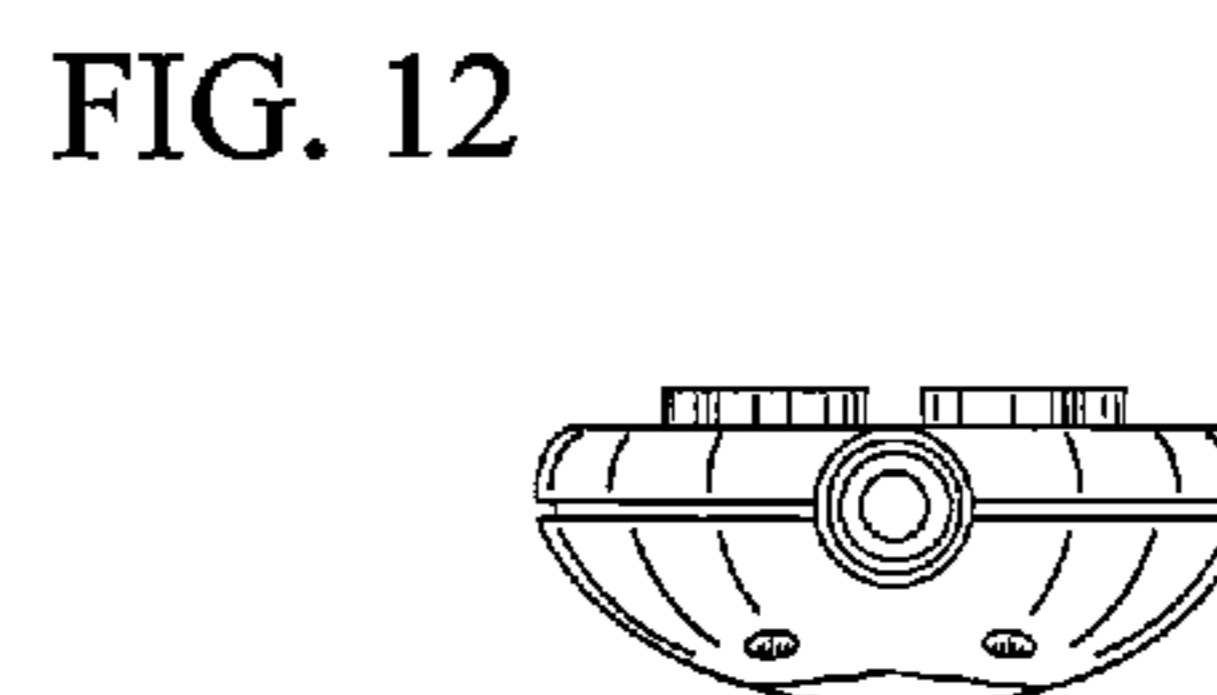
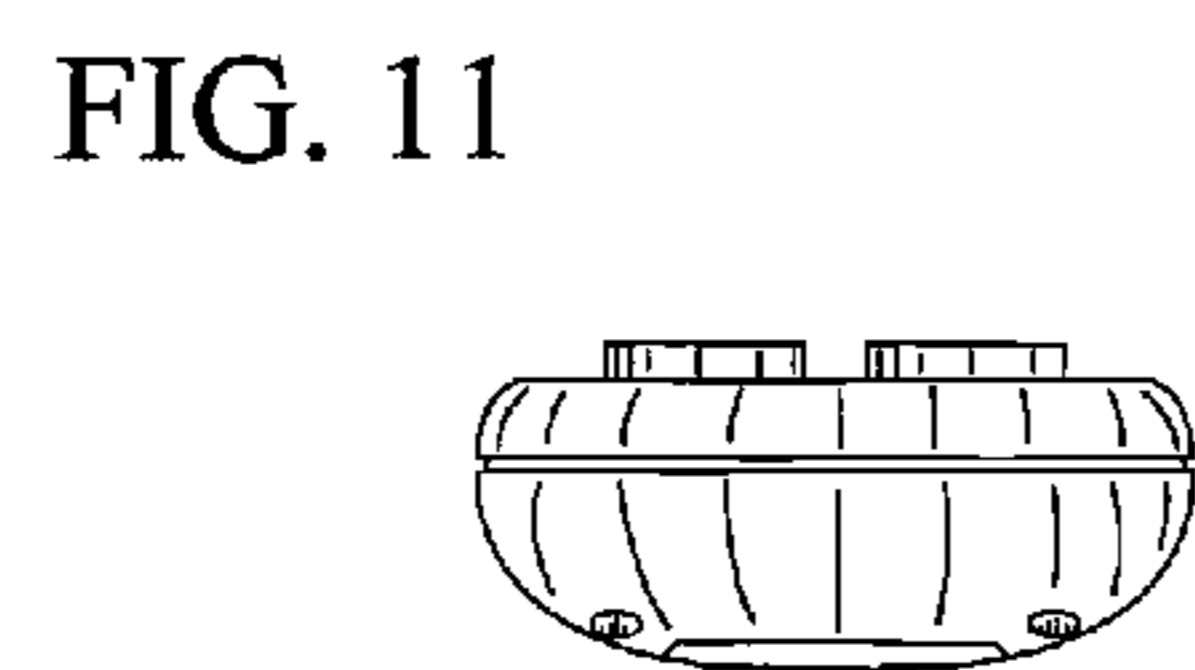
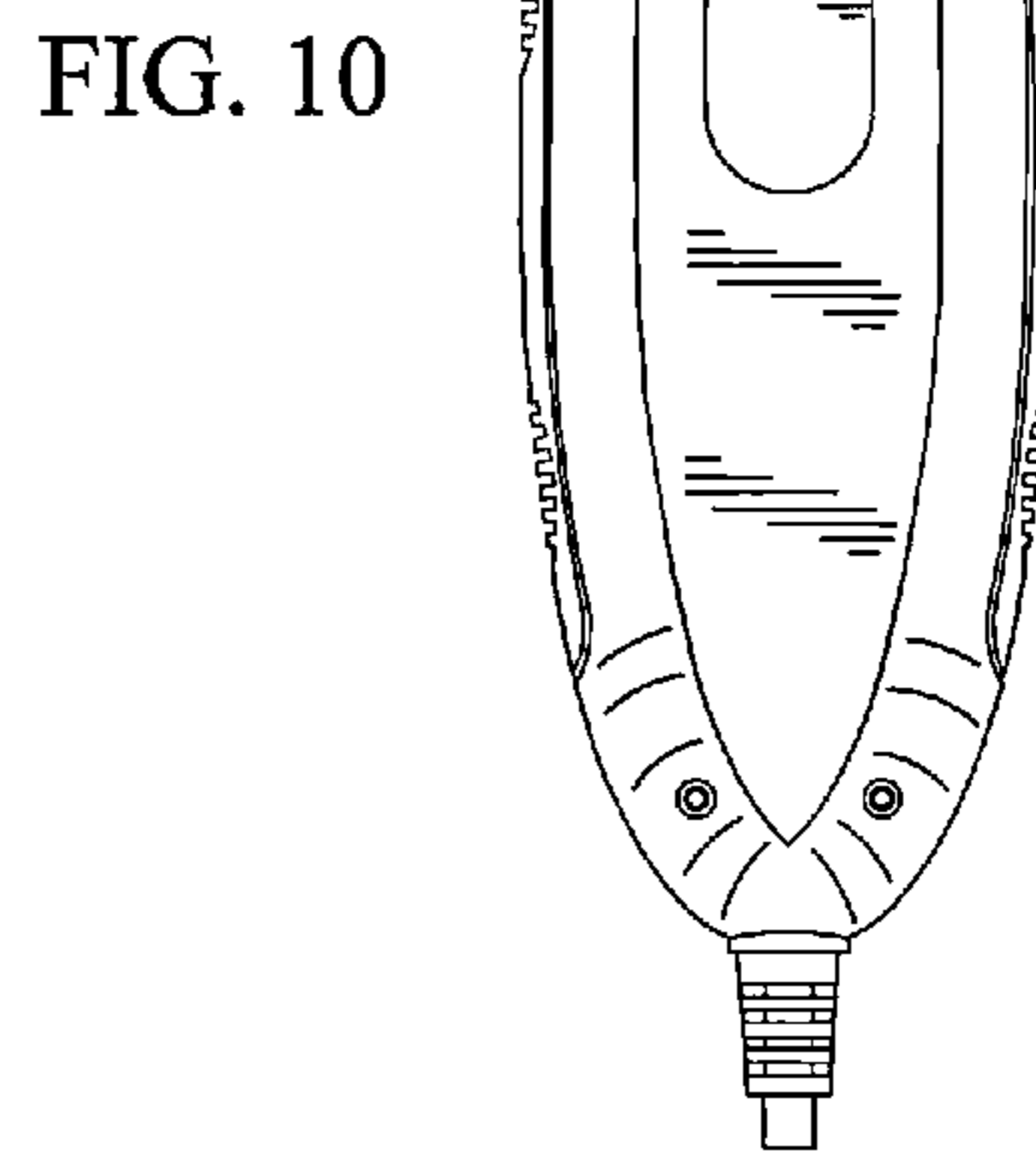
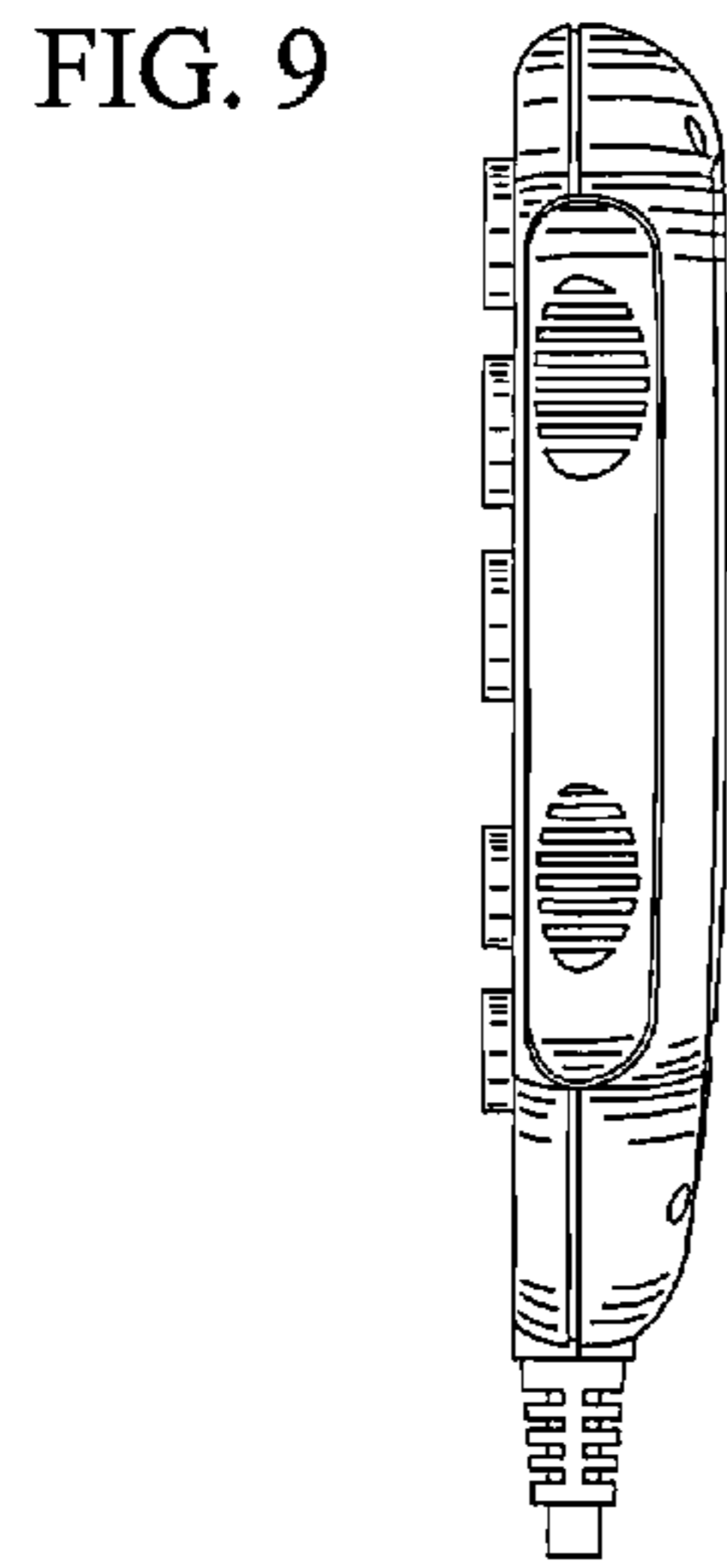
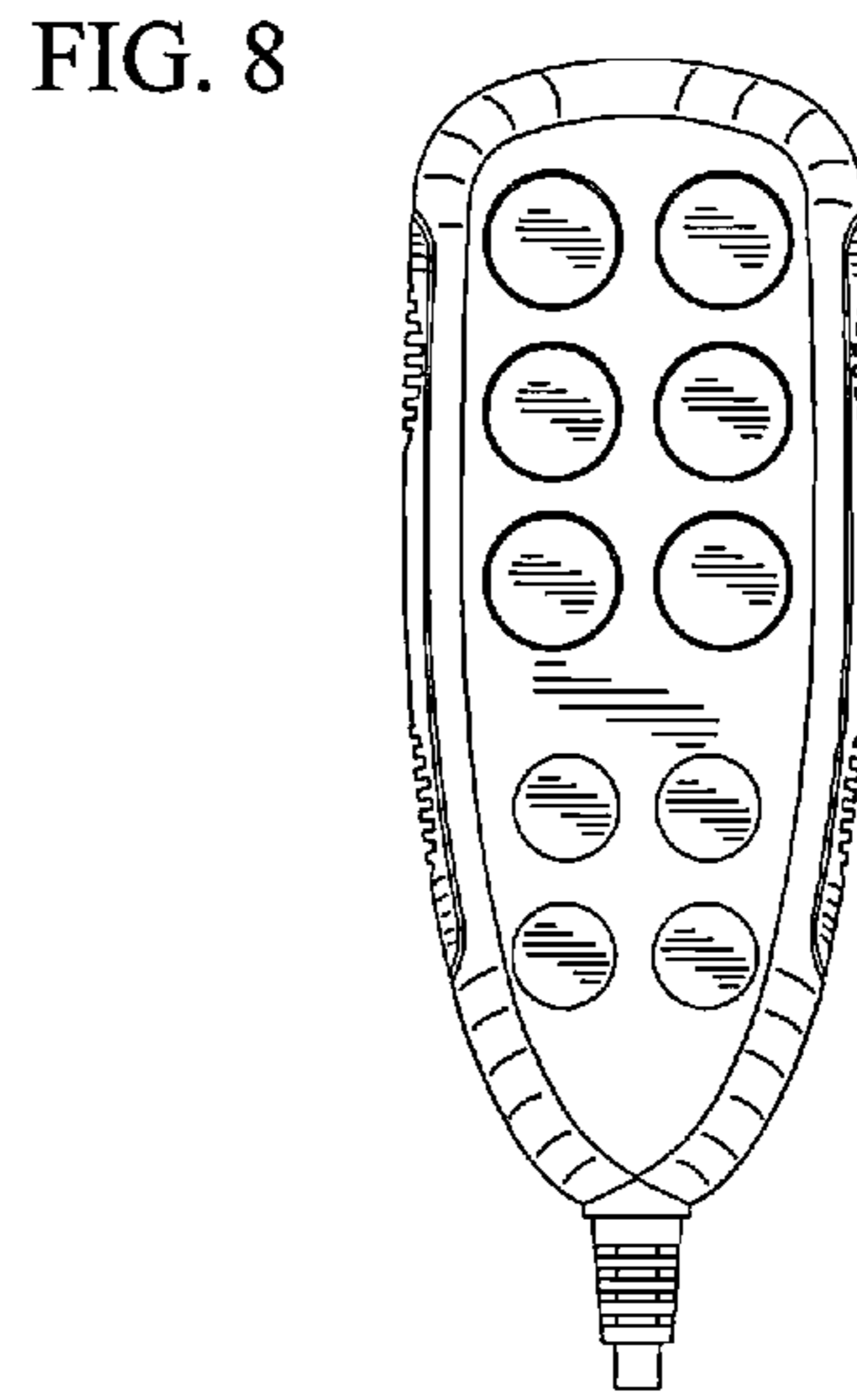
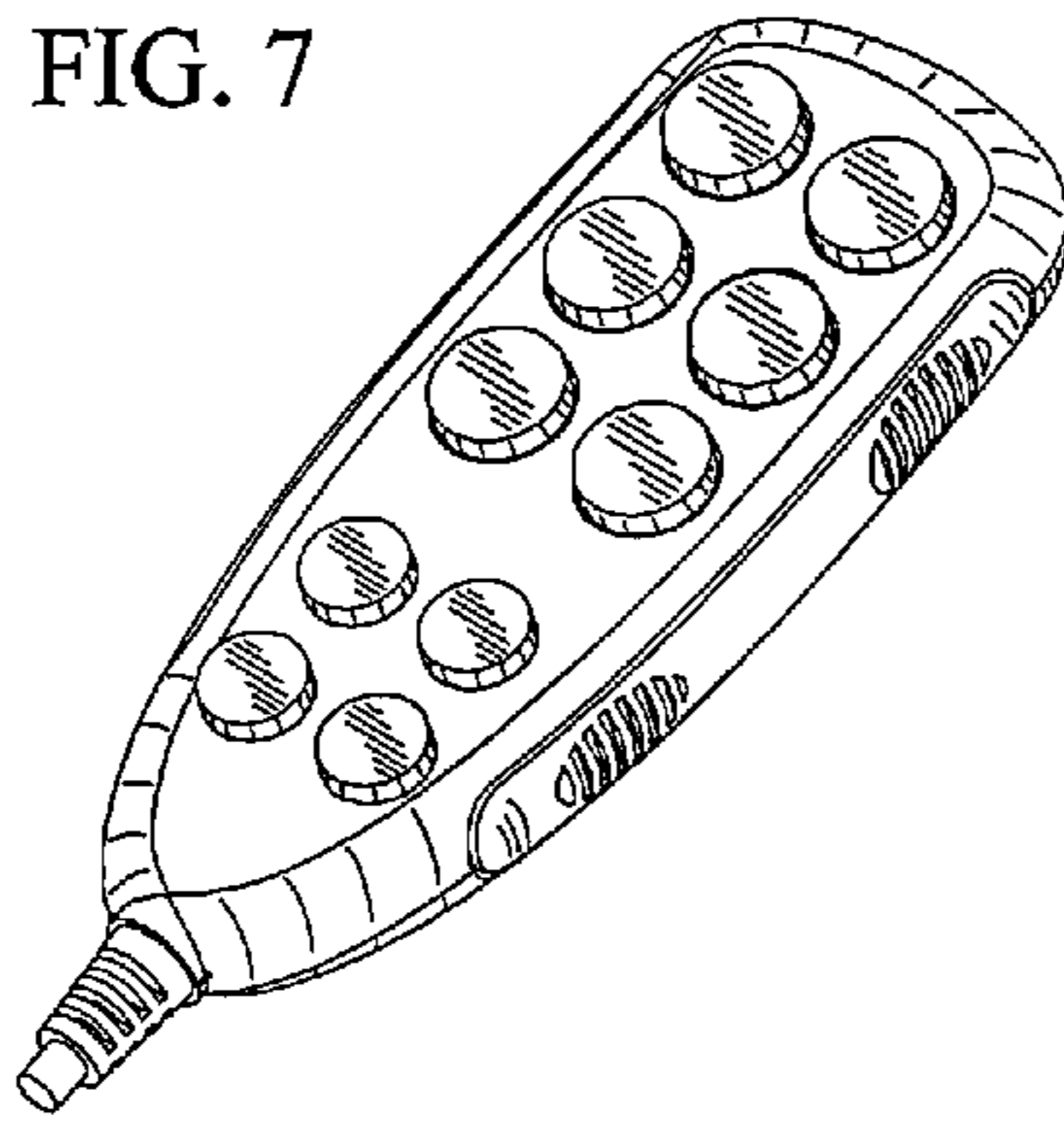

FIG. 13

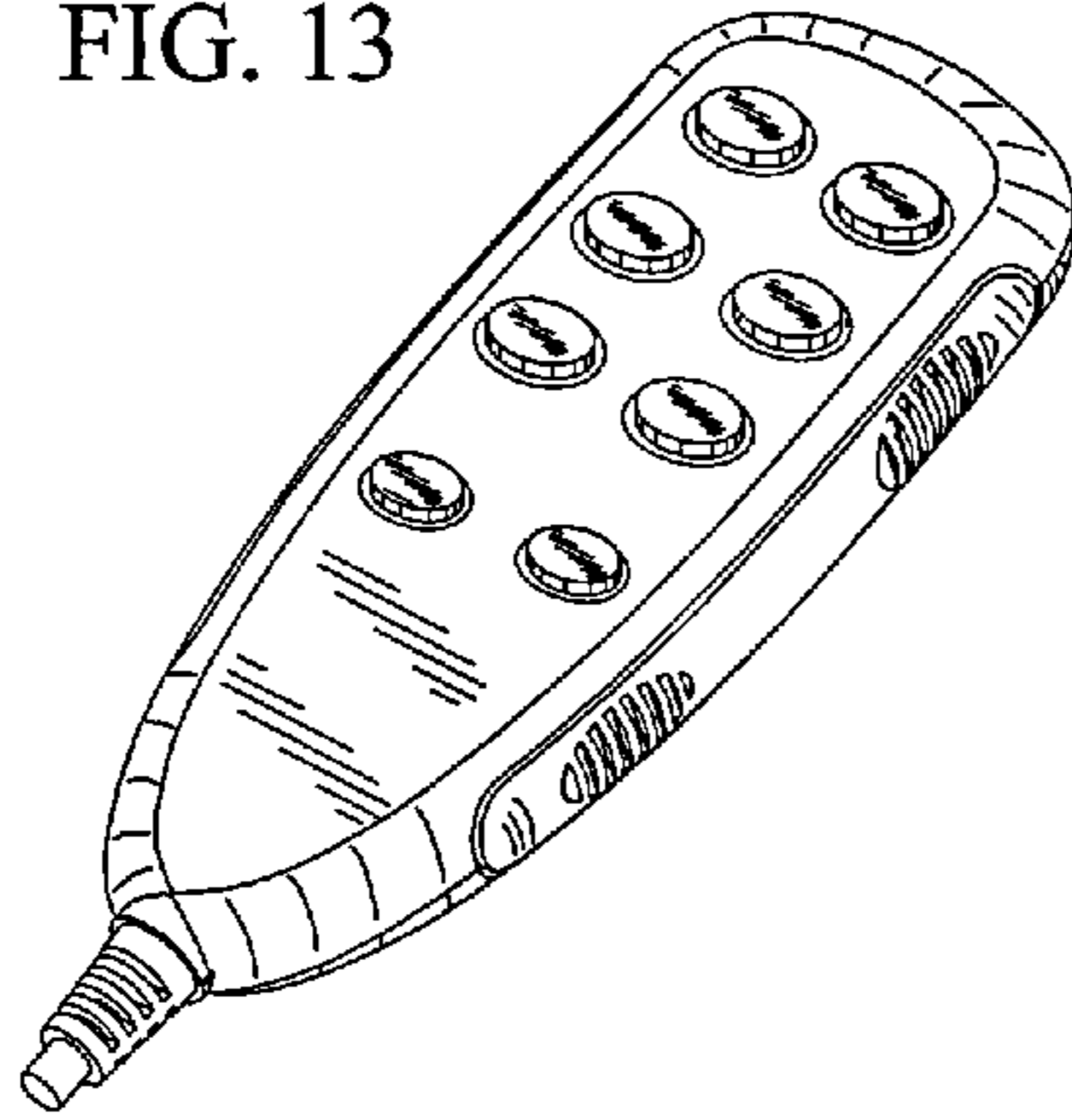

FIG. 14

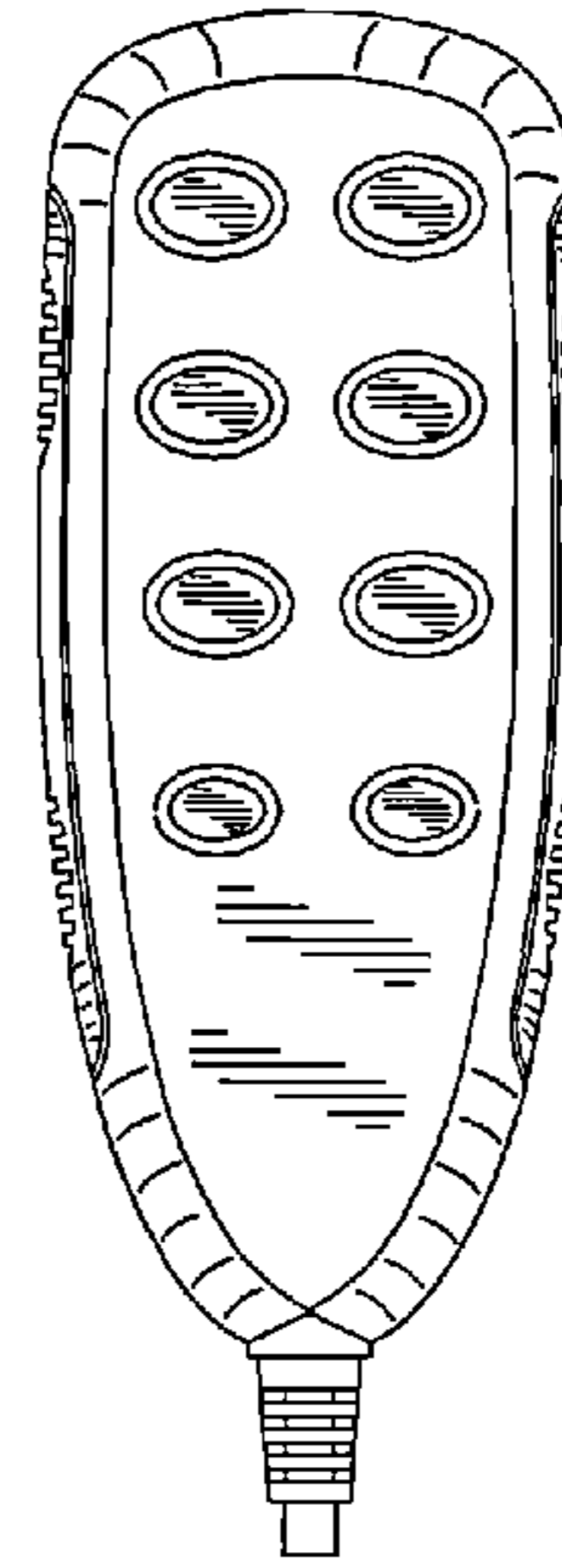

FIG. 15

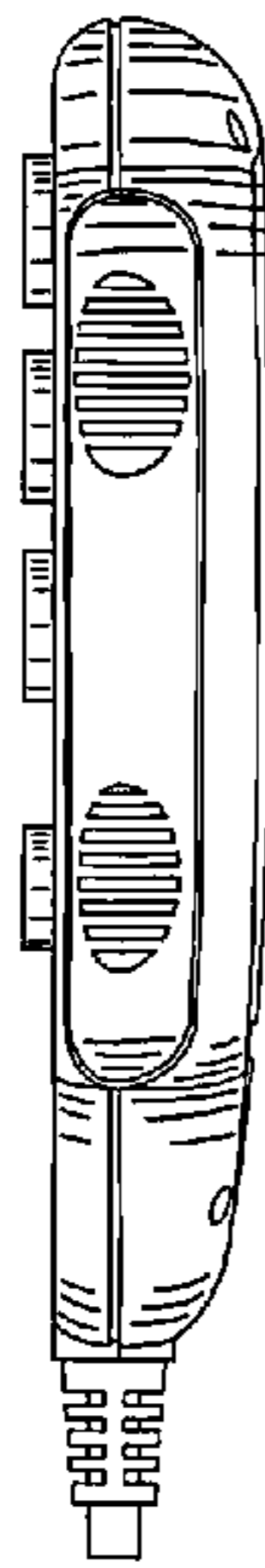

FIG. 16

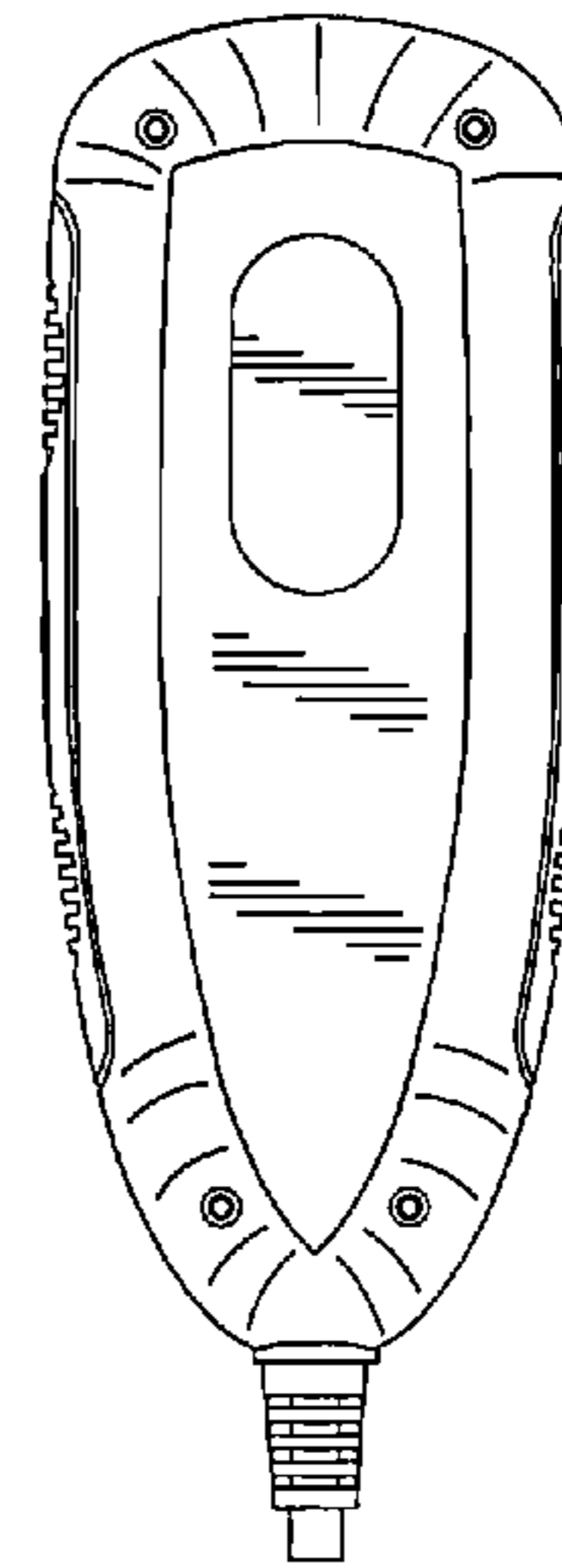

FIG. 17

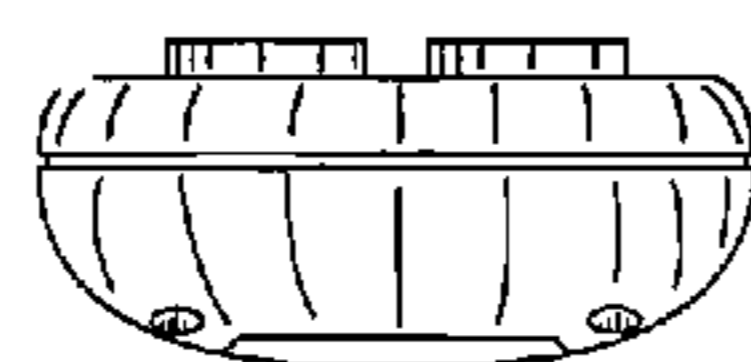

FIG. 18

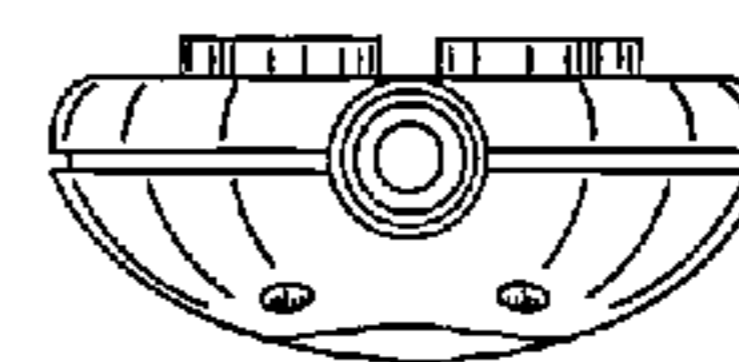

FIG. 19

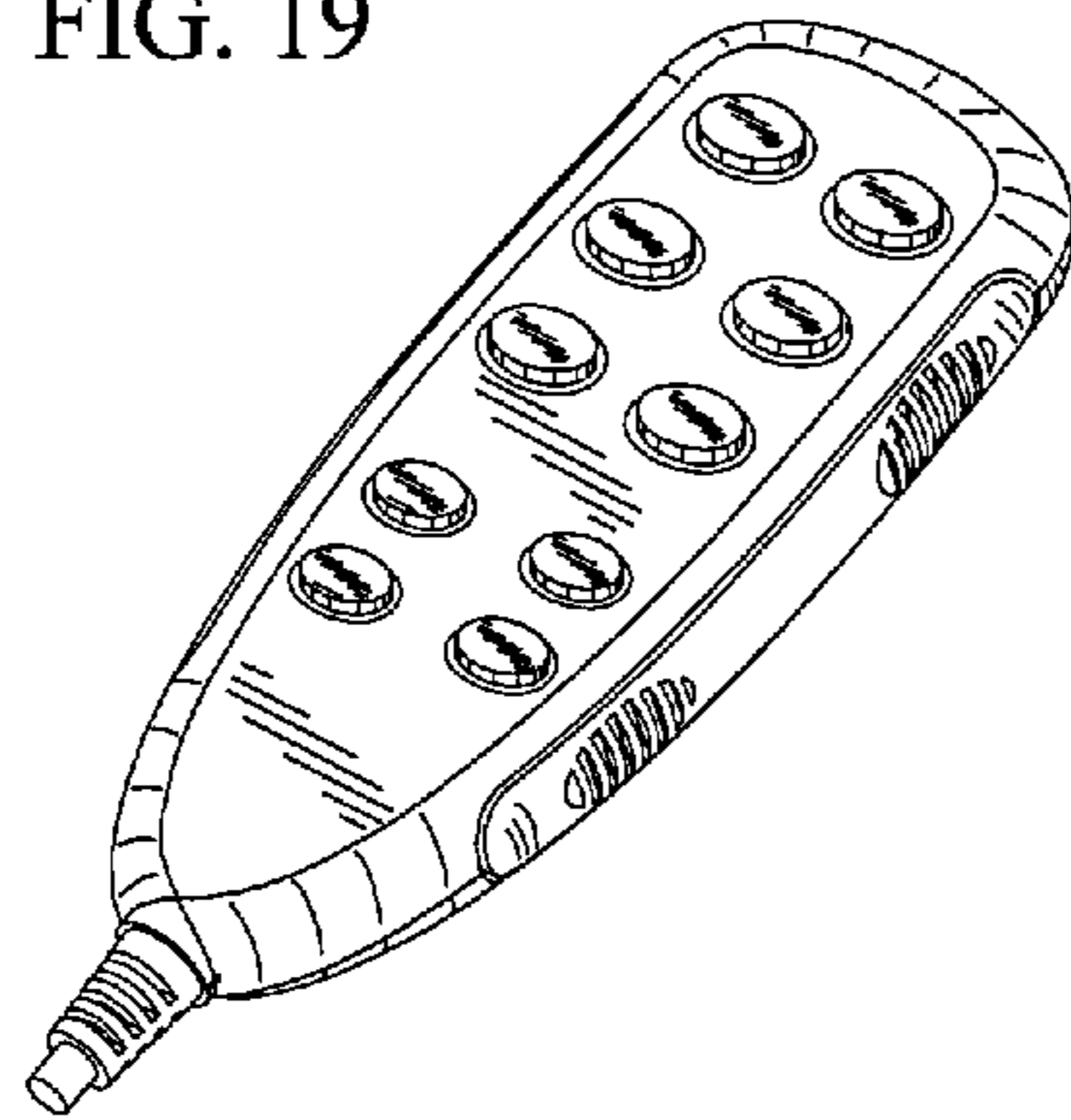

FIG. 20

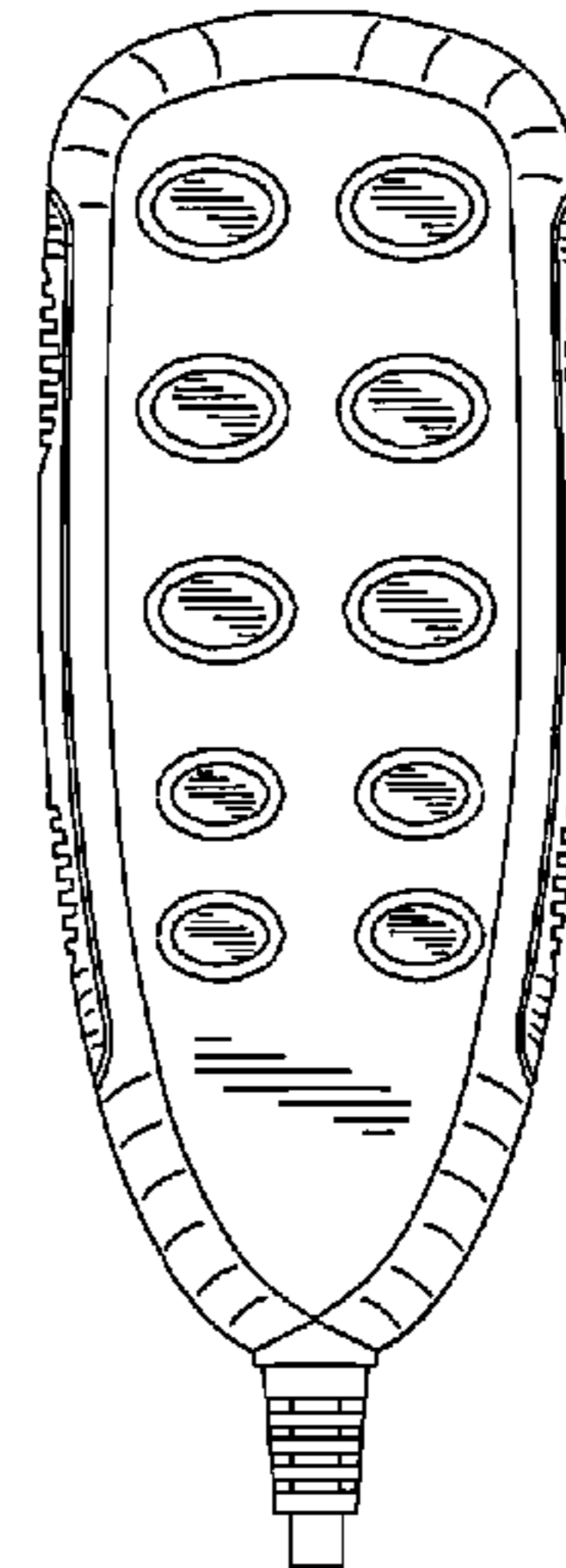

FIG. 21

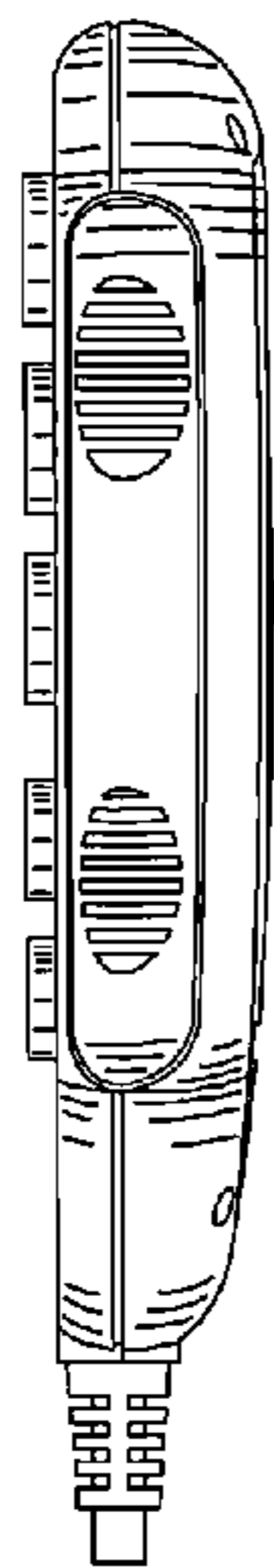

FIG. 22

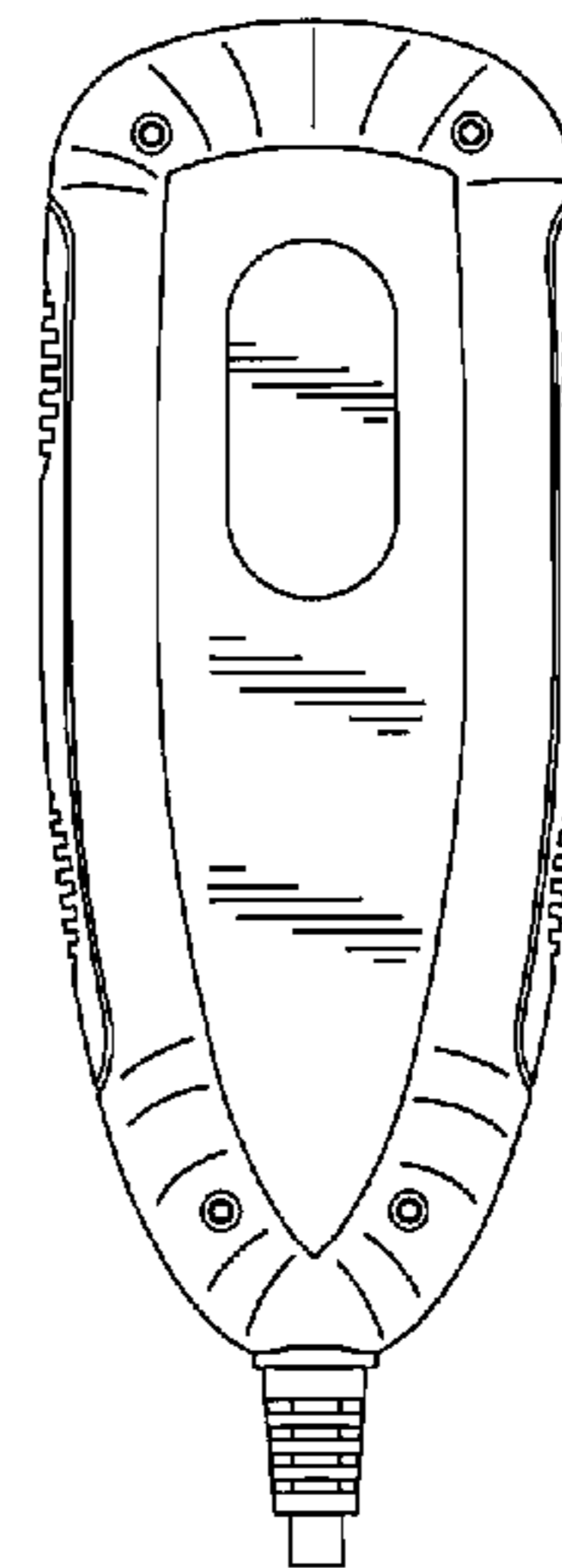

FIG. 23

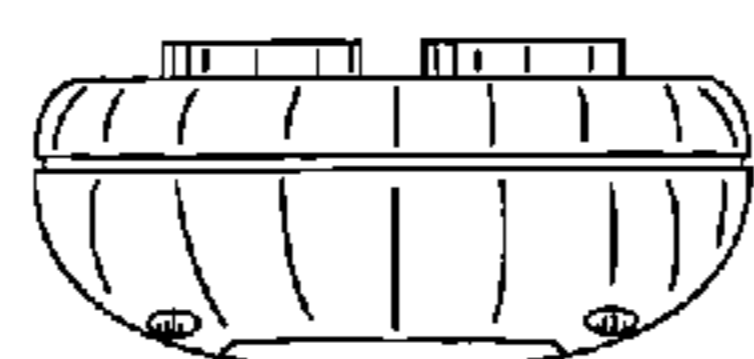

FIG. 24

