



US00D670628S

(12) **United States Design Patent**
Tasaki et al.

(10) **Patent No.:** **US D670,628 S**

(45) **Date of Patent:** **** Nov. 13, 2012**

(54) **CAR STEERING CONSOLE**

(75) Inventors: **Katsuhide Tasaki**, Ibaraki (JP); **Akiko Uehara**, Tokyo (JP); **Ryo Sato**, Tokyo (JP)

(73) Assignee: **Clarion Co., Ltd.**, Saitama (JP)

(**) Term: **14 Years**

(21) Appl. No.: **29/396,272**

(22) Filed: **Jun. 28, 2011**

(30) **Foreign Application Priority Data**

Dec. 28, 2010 (JP) 2010-31358

(51) **LOC (9) Cl.** **12-16**

(52) **U.S. Cl.** **D12/176**

(58) **Field of Classification Search** D12/175,
D12/176; 74/552, 558, 558.5
See application file for complete search history.

(56) **References Cited**

U.S. PATENT DOCUMENTS

D463,336 S * 9/2002 Prather et al. D12/176

D463,764 S * 10/2002 Swan et al. D12/176

D464,595 S * 10/2002 Zorkendorfer et al. D12/176
D640,619 S * 6/2011 Araki et al. D12/176
D651,542 S * 1/2012 Nagasawa et al. D12/176
D653,180 S * 1/2012 Tanaka et al. D12/176

* cited by examiner

Primary Examiner — Melody N Brown

(74) *Attorney, Agent, or Firm* — Scully, Scott, Murphy & Presser, P.C.

(57) **CLAIM**

The ornamental design for a car steering console, as shown and described.

DESCRIPTION

FIG. 1 is a front perspective view of a car steering console showing our new design;

FIG. 2 is a front view thereof;

FIG. 3 is a rear view thereof;

FIG. 4 is a right side view thereof;

FIG. 5 is a left side view thereof;

FIG. 6 is a top view thereof; and,

FIG. 7 is a bottom view thereof.

The portions of the console indicated in broken lines are for illustrative purposes only and form no part of the claimed design.

1 Claim, 4 Drawing Sheets

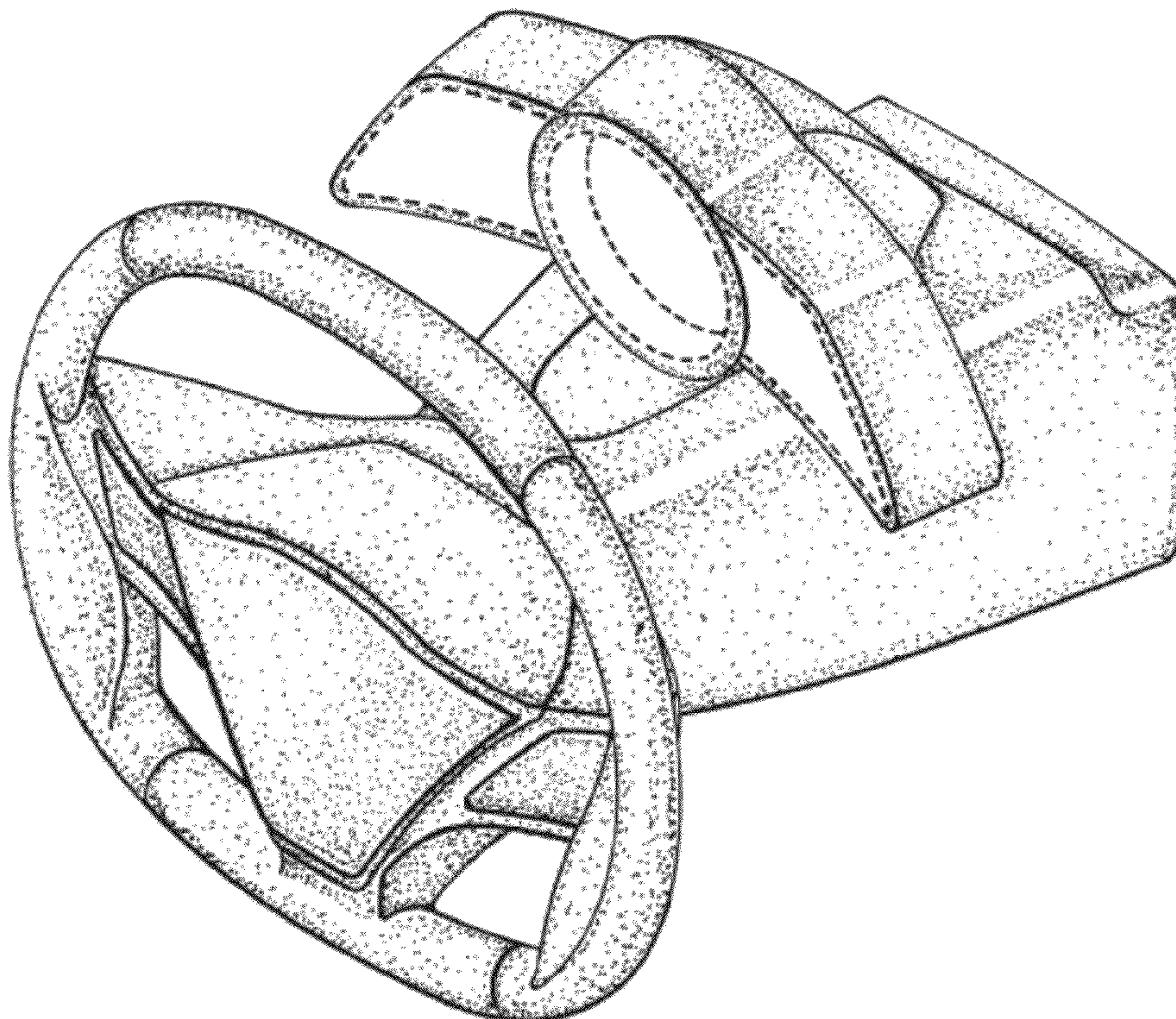

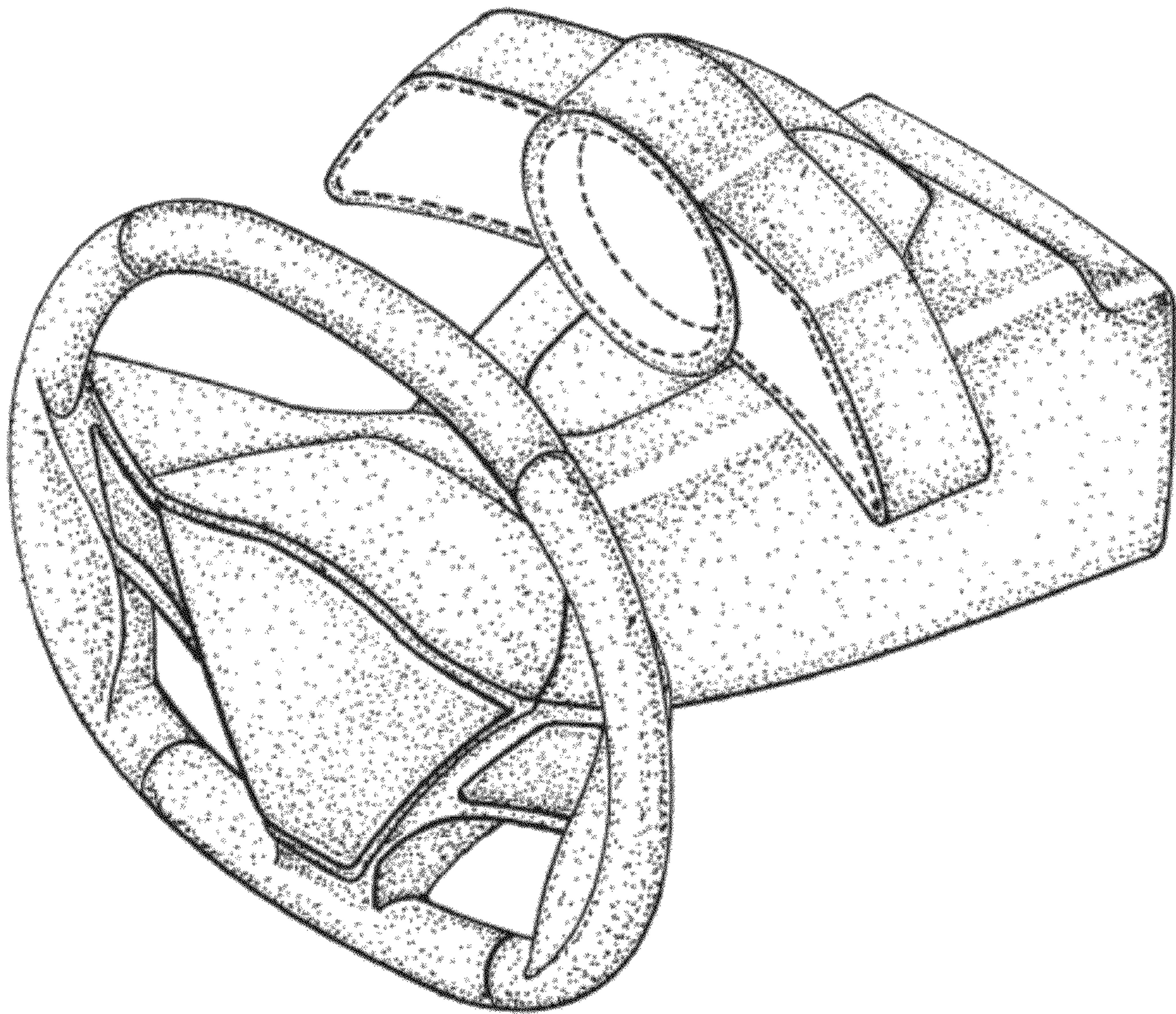

Fig. 1

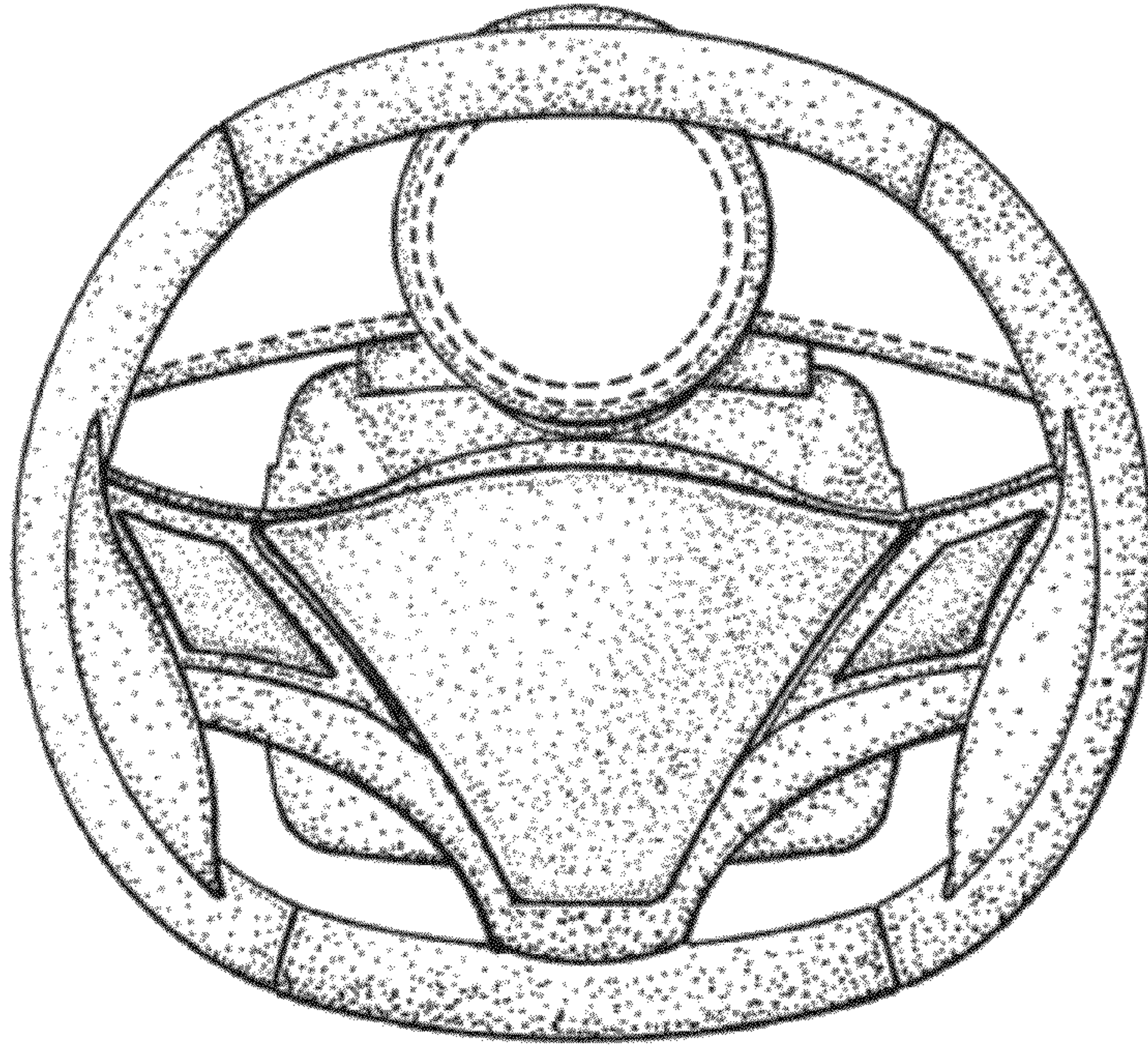

Fig. 2

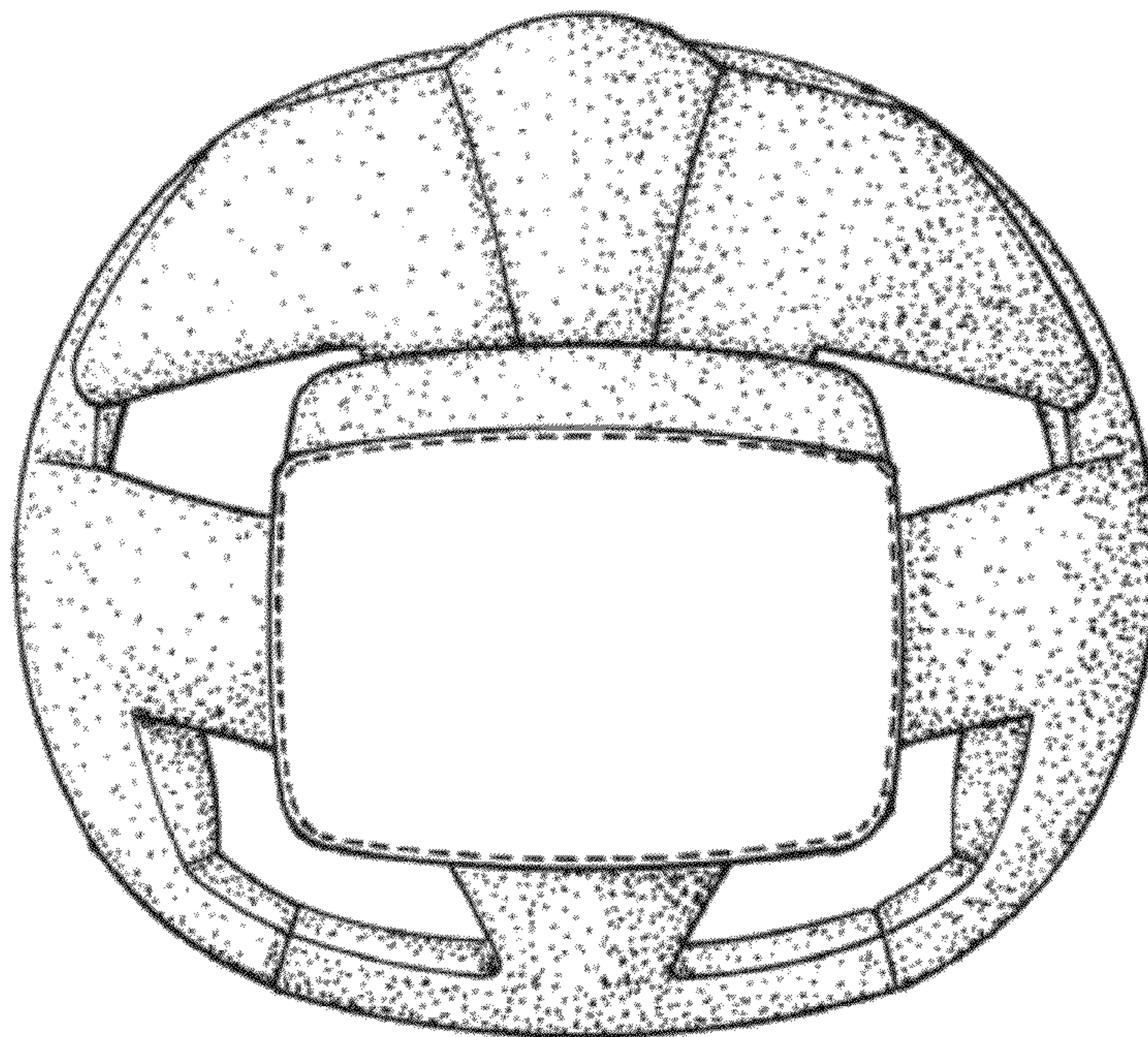

Fig. 3

Fig. 4

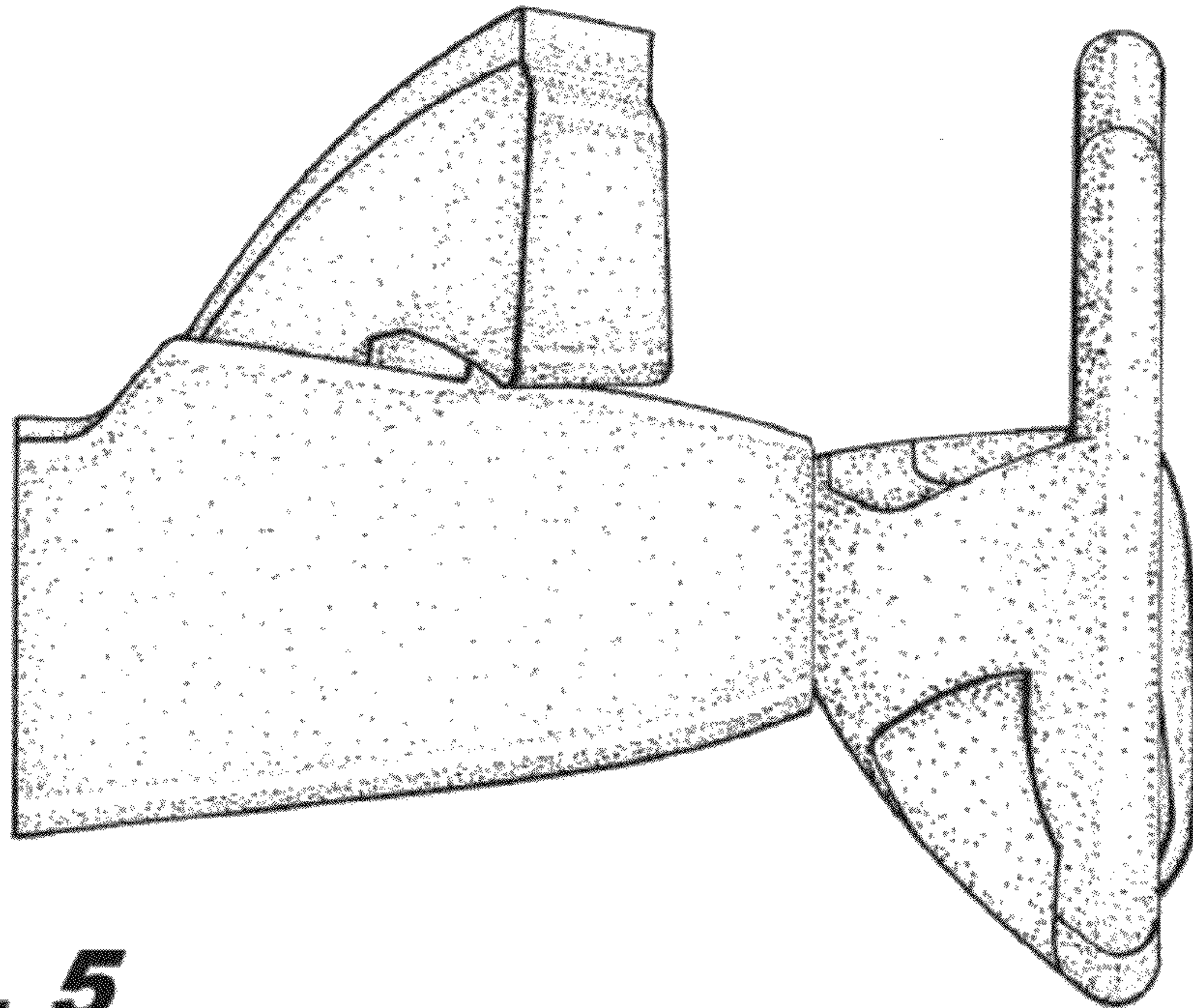
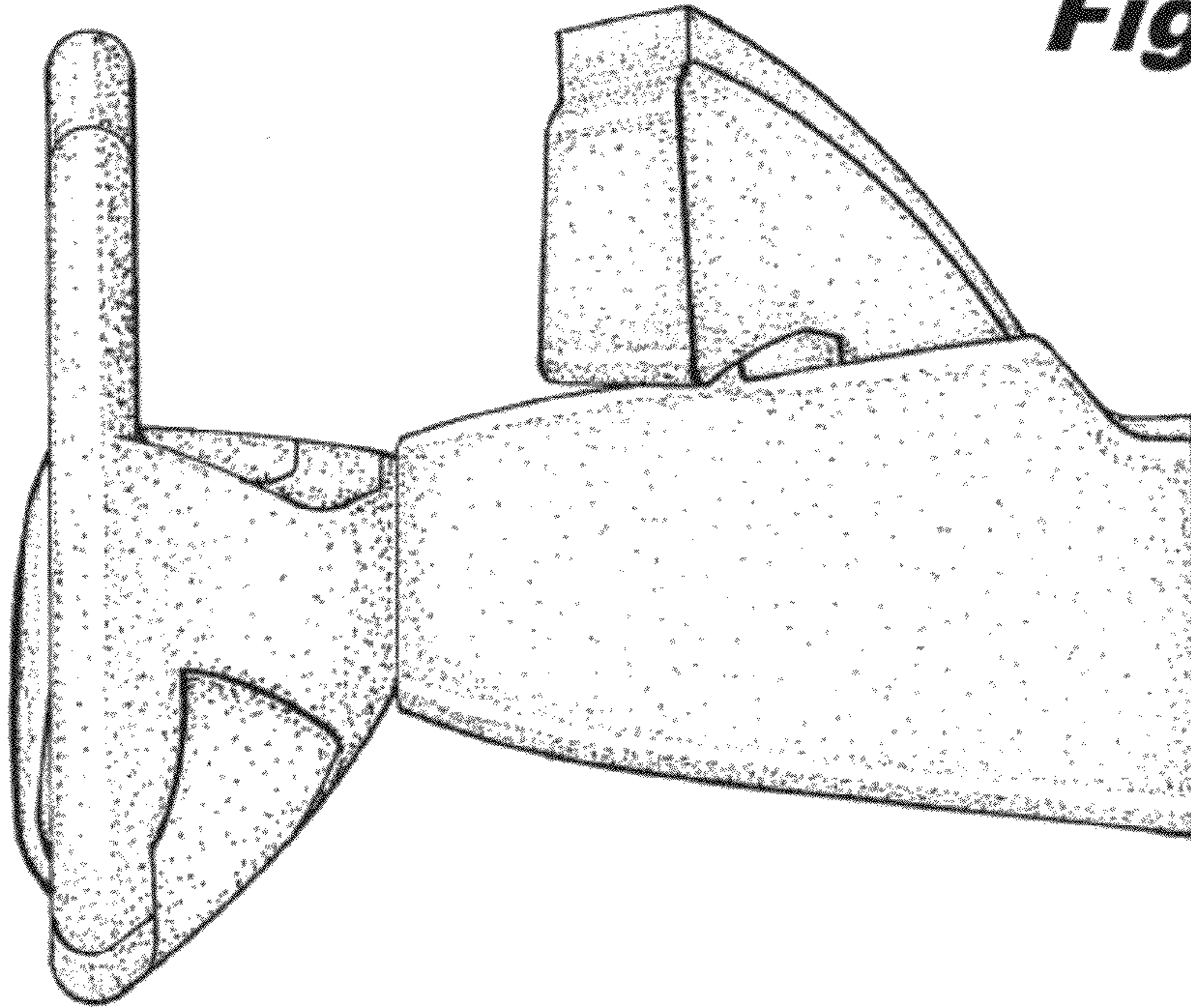

Fig. 5

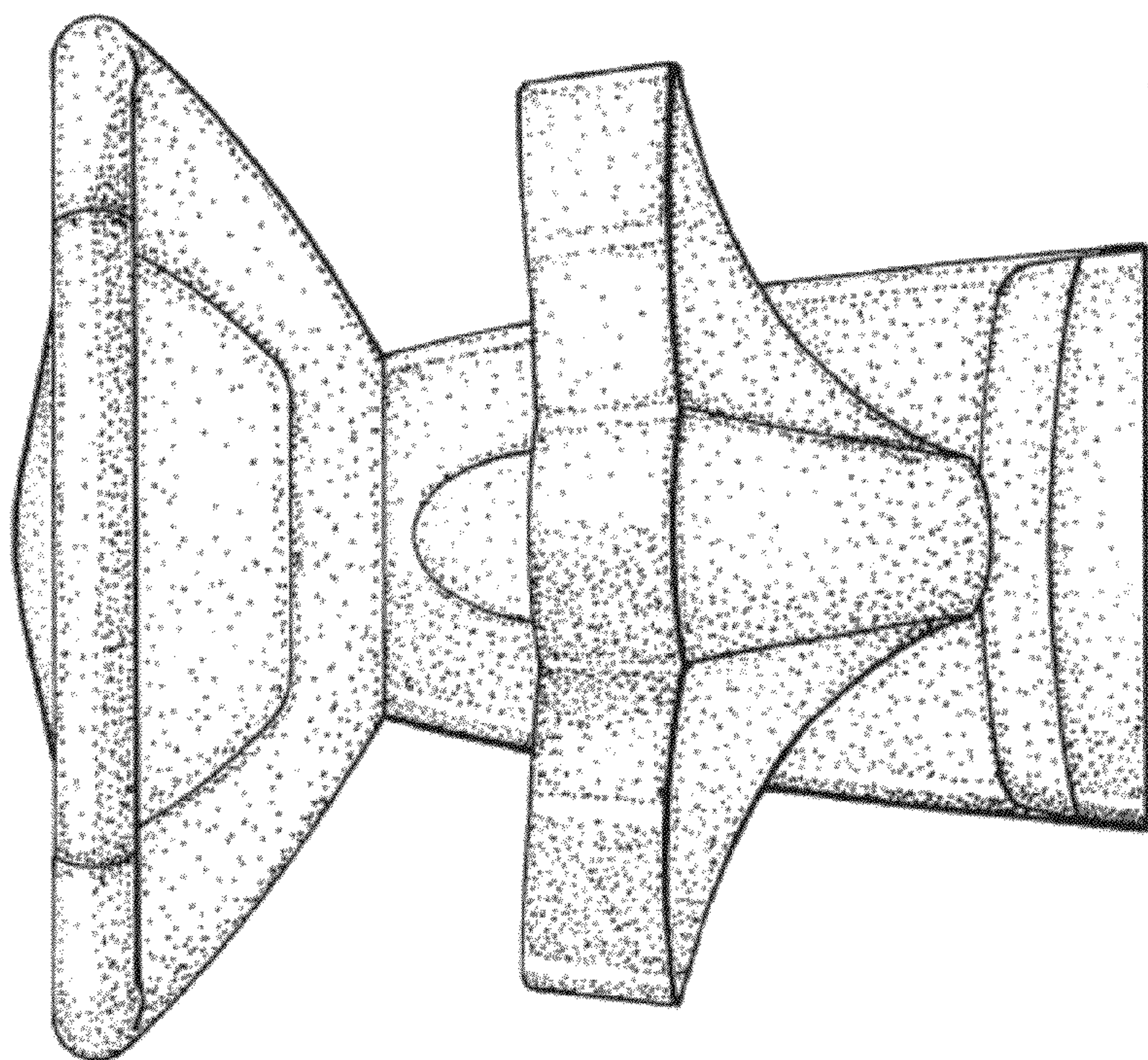

Fig. 6

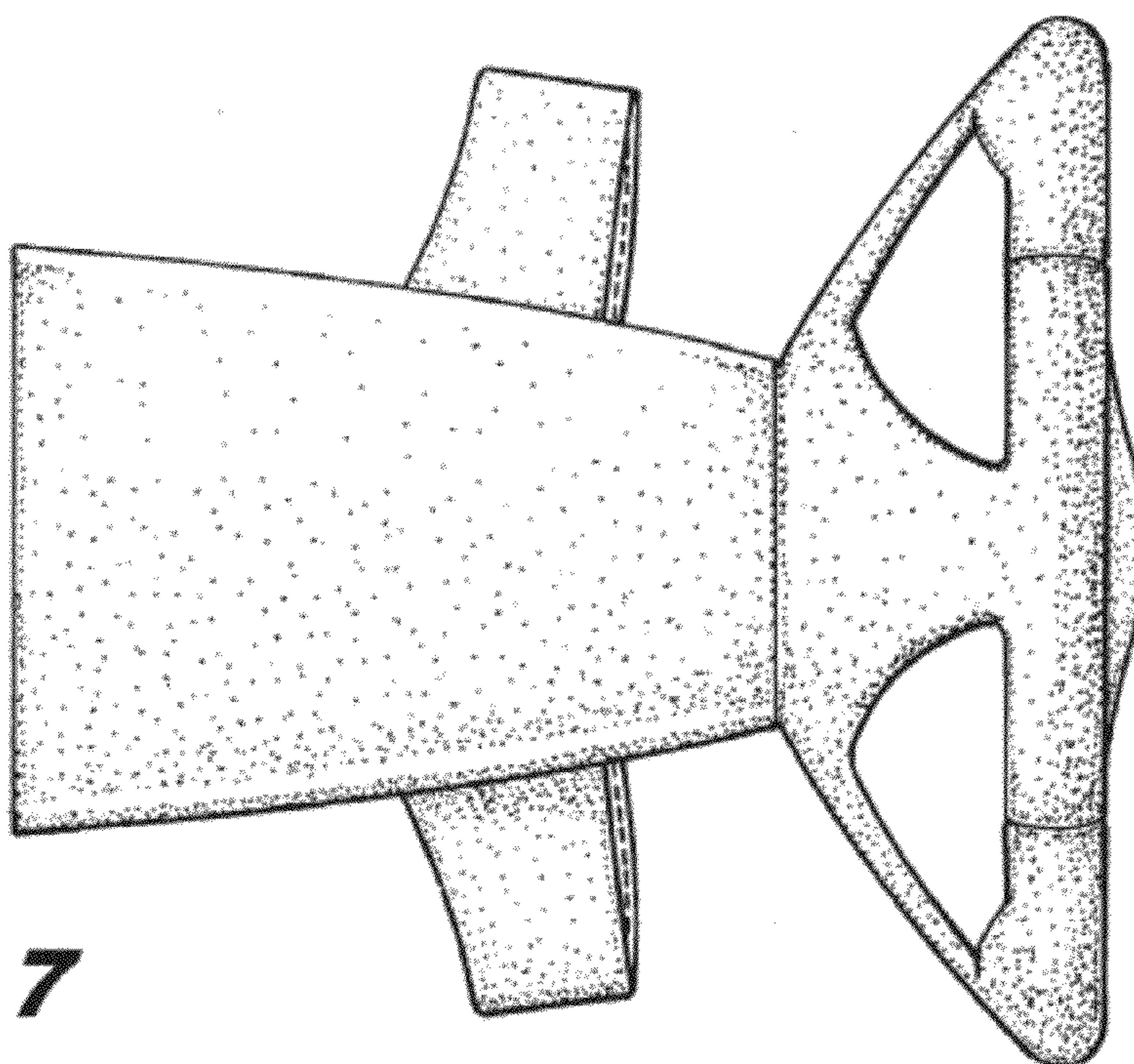

Fig. 7