



US00D670549S

(12) **United States Design Patent**  
**Yang**

(10) **Patent No.:** **US D670,549 S**

(45) **Date of Patent:** **\*\* Nov. 13, 2012**

- (54) **ROTARY WRENCH CONNECTOR**
- (75) Inventor: **Chung-Chen Yang**, Taichung (TW)
- (73) Assignee: **Chung-Cheng Yang**, Taichung (TW)
- (\*\*) Term: **14 Years**
- (21) Appl. No.: **29/385,476**
- (22) Filed: **Feb. 15, 2011**

- (51) **LOC (9) Cl.** ..... **08-05**
- (52) **U.S. Cl.** ..... **D8/21**
- (58) **Field of Classification Search** ..... D8/21-29;  
81/58.3-59.16, 177.1, 177.85, 121.1, 124.3,  
81/165-170, 110.1, 176.2, 124.6, 176.1,  
81/176.15, 177.2; 16/110.1; D15/144.1;  
219/75, 227, 229, 121.16, 121.18  
See application file for complete search history.

(56) **References Cited**

**U.S. PATENT DOCUMENTS**

1,398,234	A *	11/1921	Iandie	.....	81/450
2,951,405	A *	9/1960	Engquist	.....	81/440
4,334,445	A *	6/1982	Timewell	.....	81/177.7
4,461,192	A *	7/1984	Suligoy et al.	.....	81/177.6
6,382,058	B1 *	5/2002	Owoc	.....	81/177.9
7,066,059	B1 *	6/2006	Hsieh	.....	81/177.7
7,591,208	B2 *	9/2009	Cole	.....	81/177.8
2010/0154604	A1 *	6/2010	Su	.....	81/450

\* cited by examiner

*Primary Examiner* — Raphael Barkai  
*Assistant Examiner* — Randall Gholson  
 (74) *Attorney, Agent, or Firm* — Alan Kamrath; Kamrath IP Lawfirm, PA

(57) **CLAIM**

The ornamental design for a rotary wrench connector, as shown and described.

**DESCRIPTION**

FIG. 1 is a perspective view of a rotary wrench connector showing my design;  
 FIG. 2 is a front elevational view thereof;  
 FIG. 3 is a rear elevational view thereof;  
 FIG. 4 is a left side elevational view thereof;  
 FIG. 5 is a right side elevational view thereof;  
 FIG. 6 is a top plan view thereof;  
 FIG. 7 is a bottom plan view thereof;  
 FIG. 8 is a perspective schematic view illustrating a first application of a rotary wrench connector showing my design. The broken lines shown in the figure are for illustrative purposes only and form no part of the claimed design; and,  
 FIG. 9 is a perspective schematic view illustrating a second application of a rotary wrench connector showing my design. The broken lines shown in the figure are for illustrative purposes only and form no part of the claimed design.

**1 Claim, 6 Drawing Sheets**

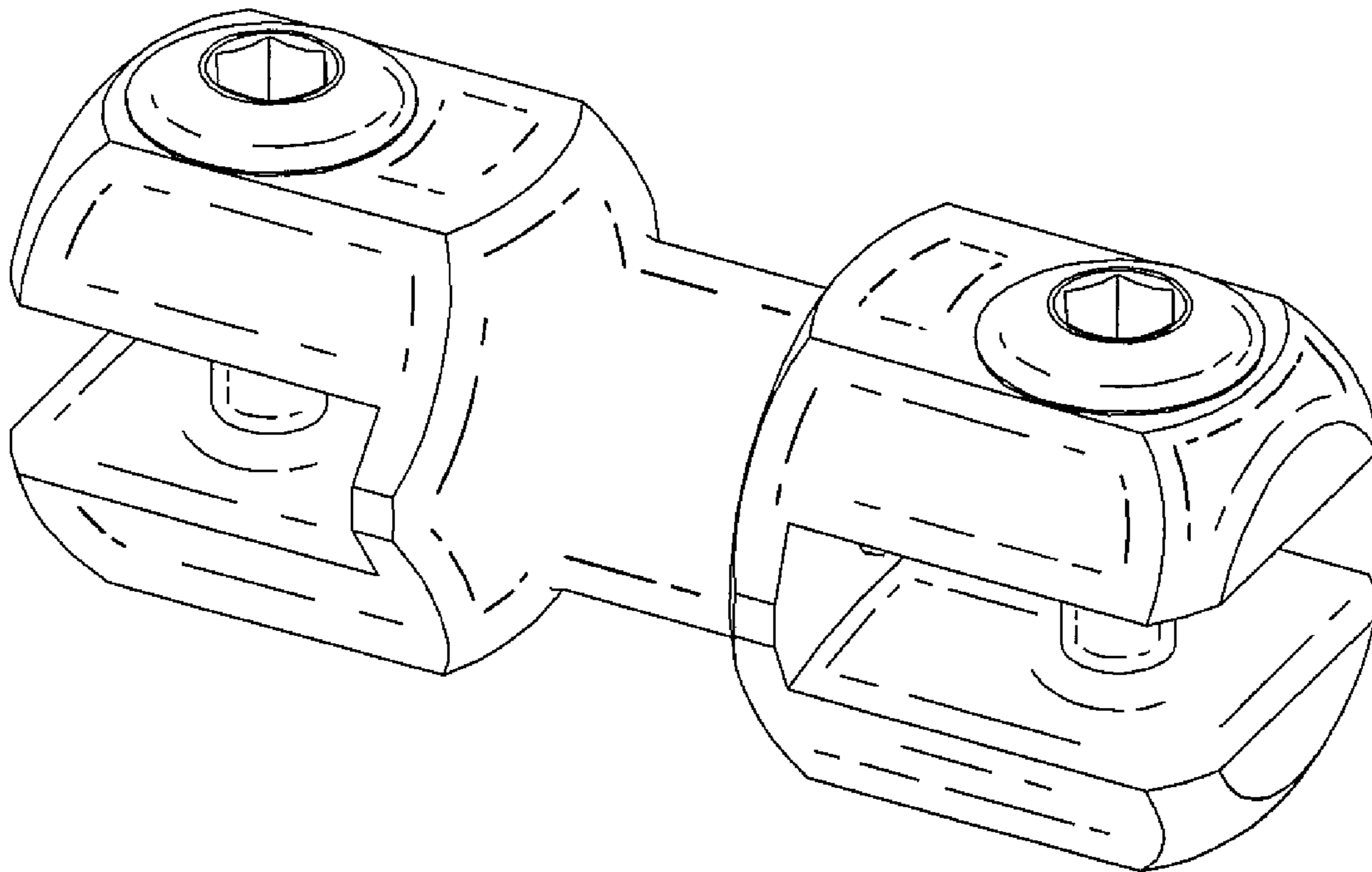

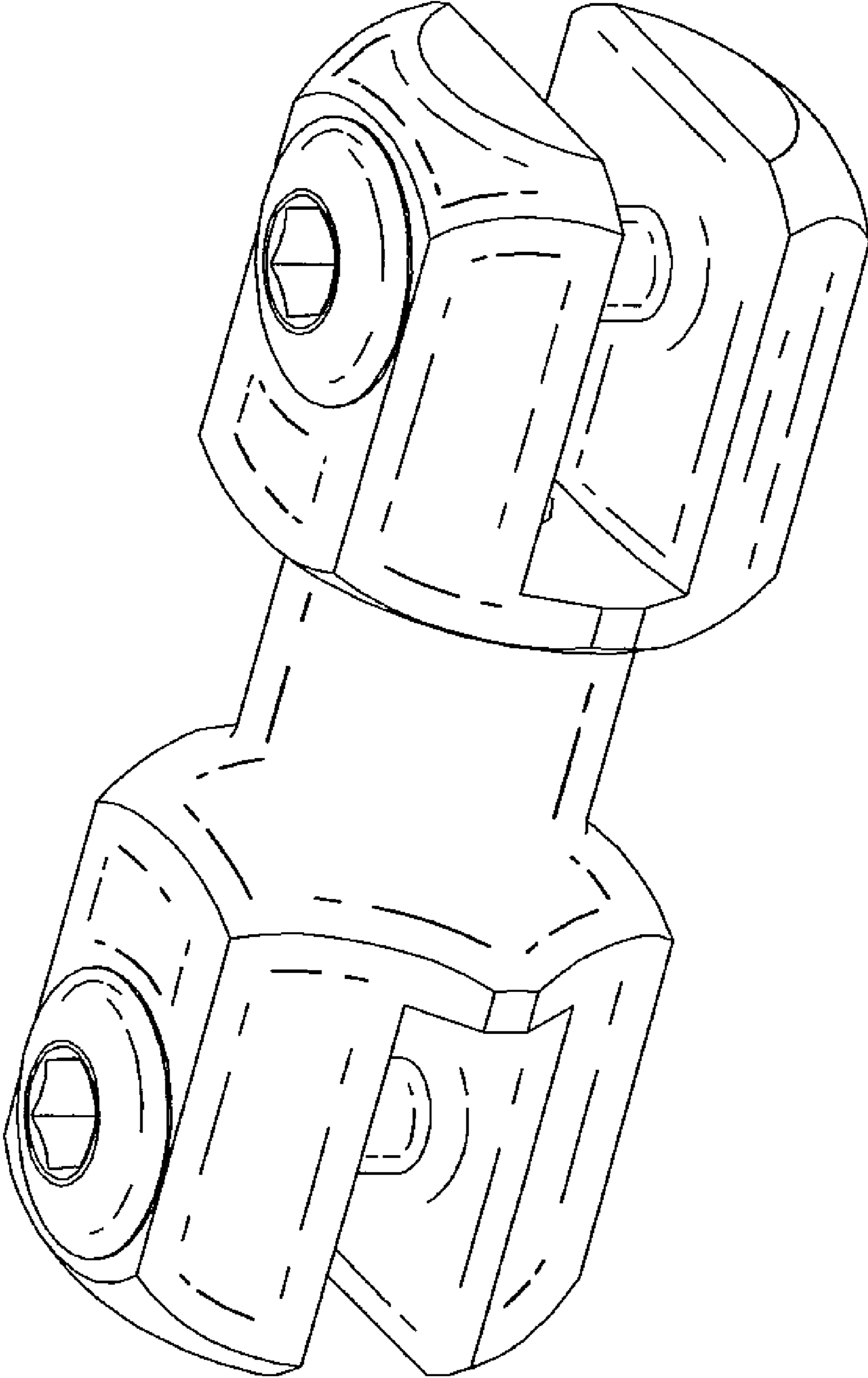

FIG. 1

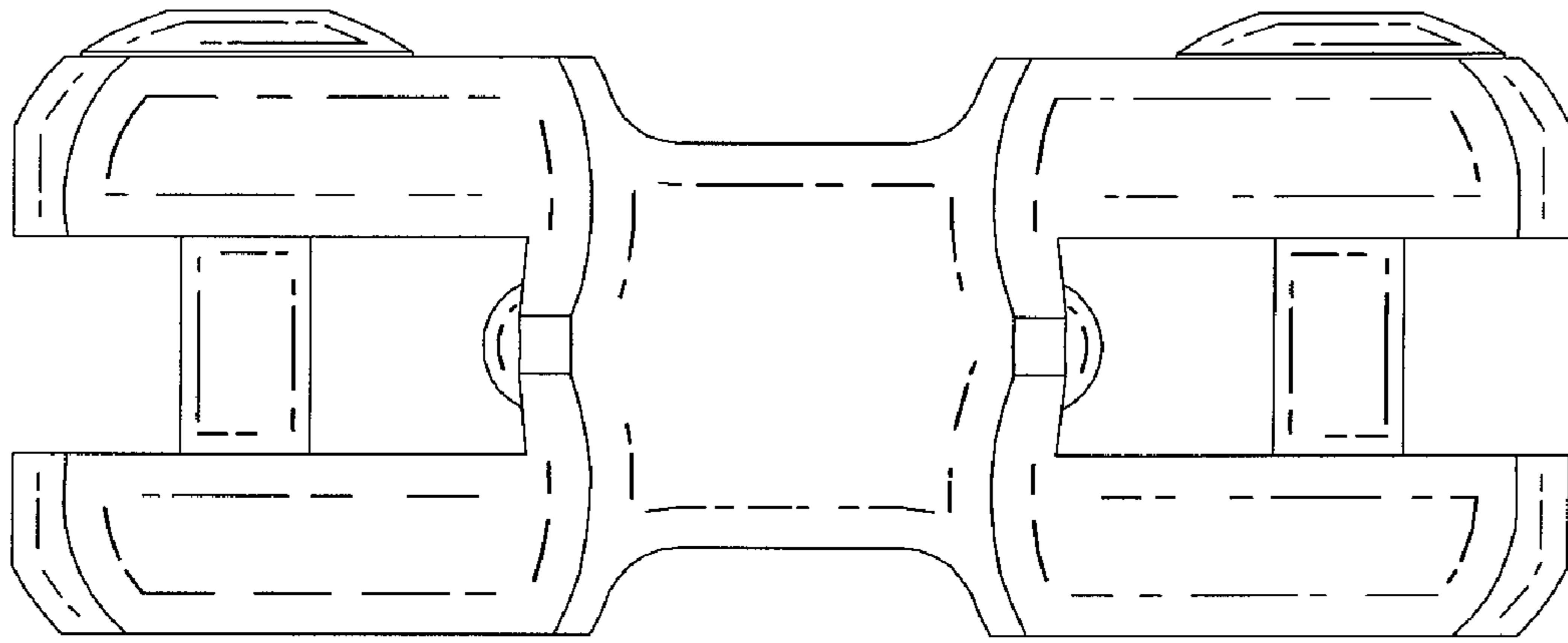

FIG. 2

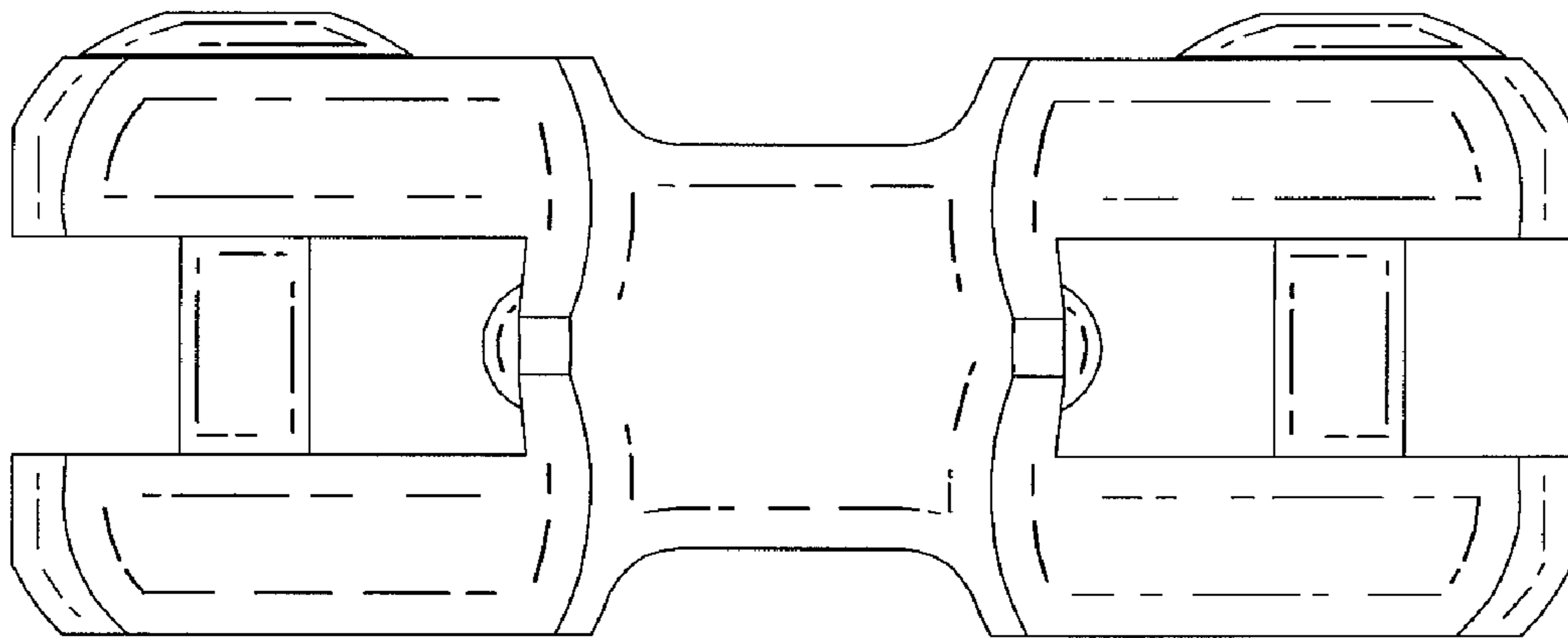

FIG. 3

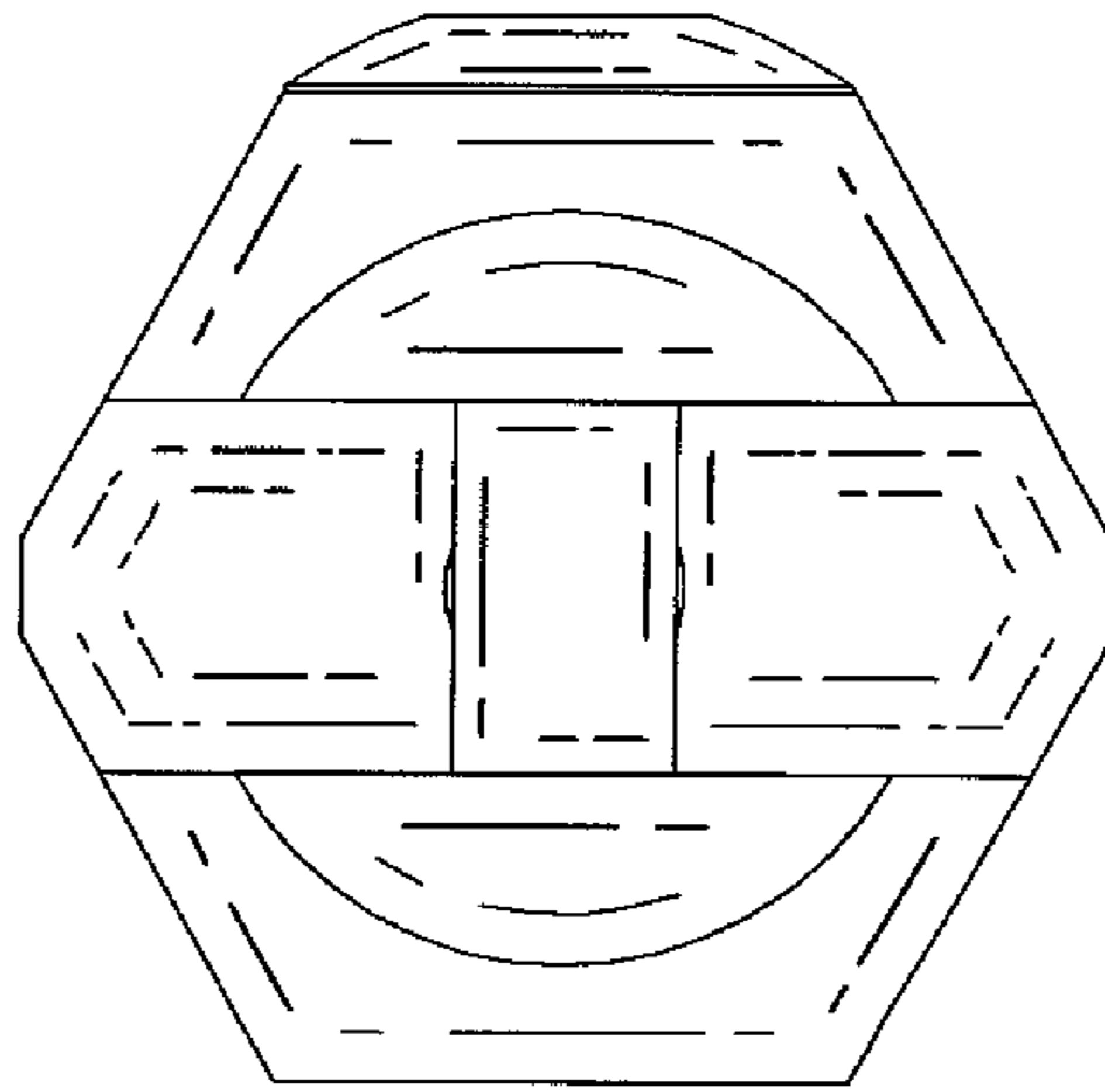

FIG. 4

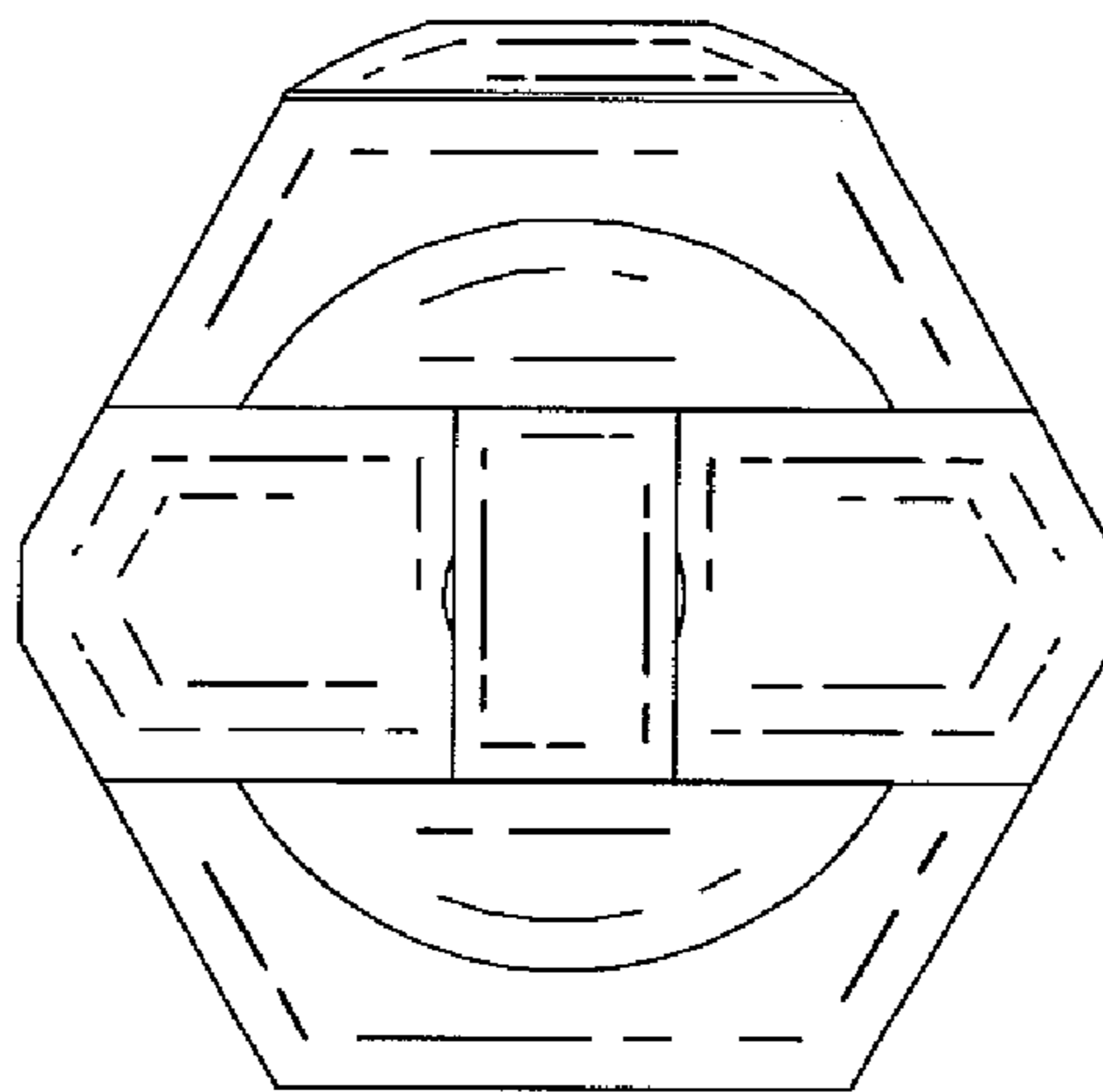

FIG. 5

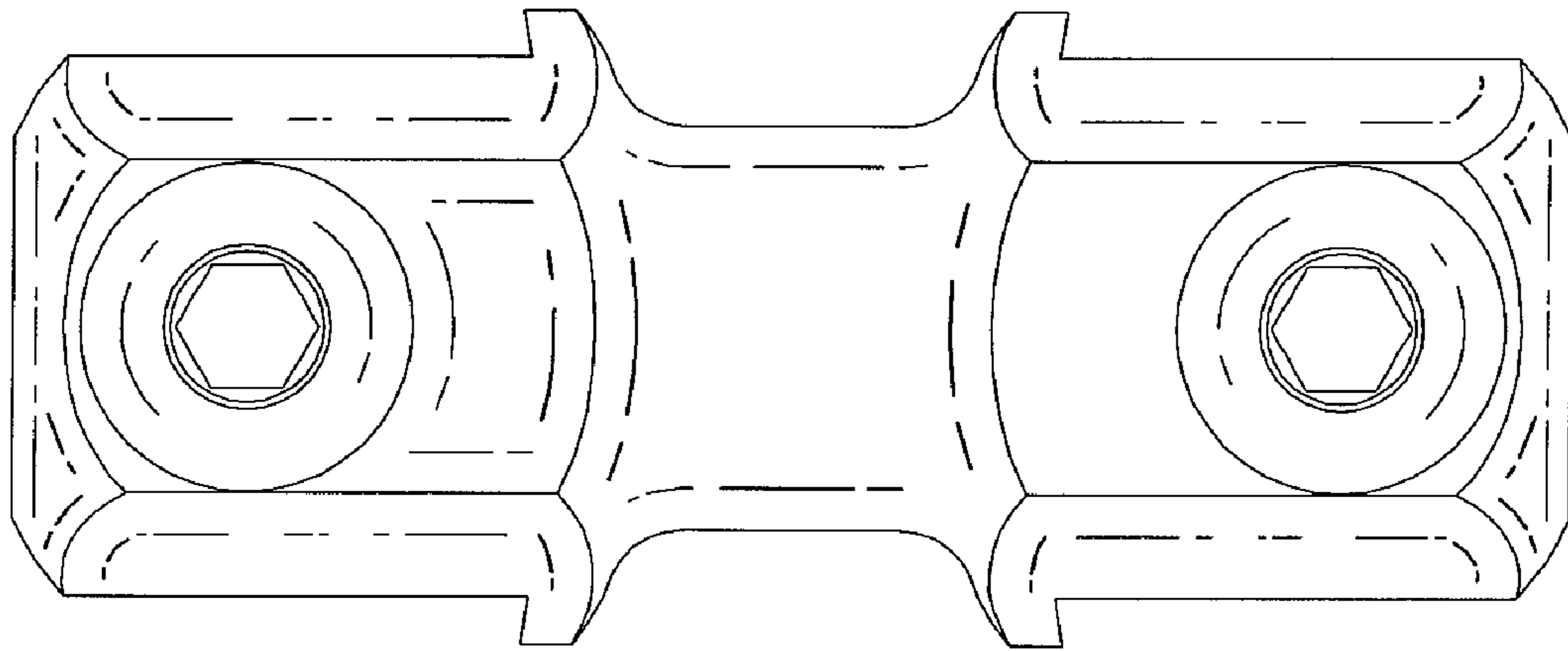

FIG. 6

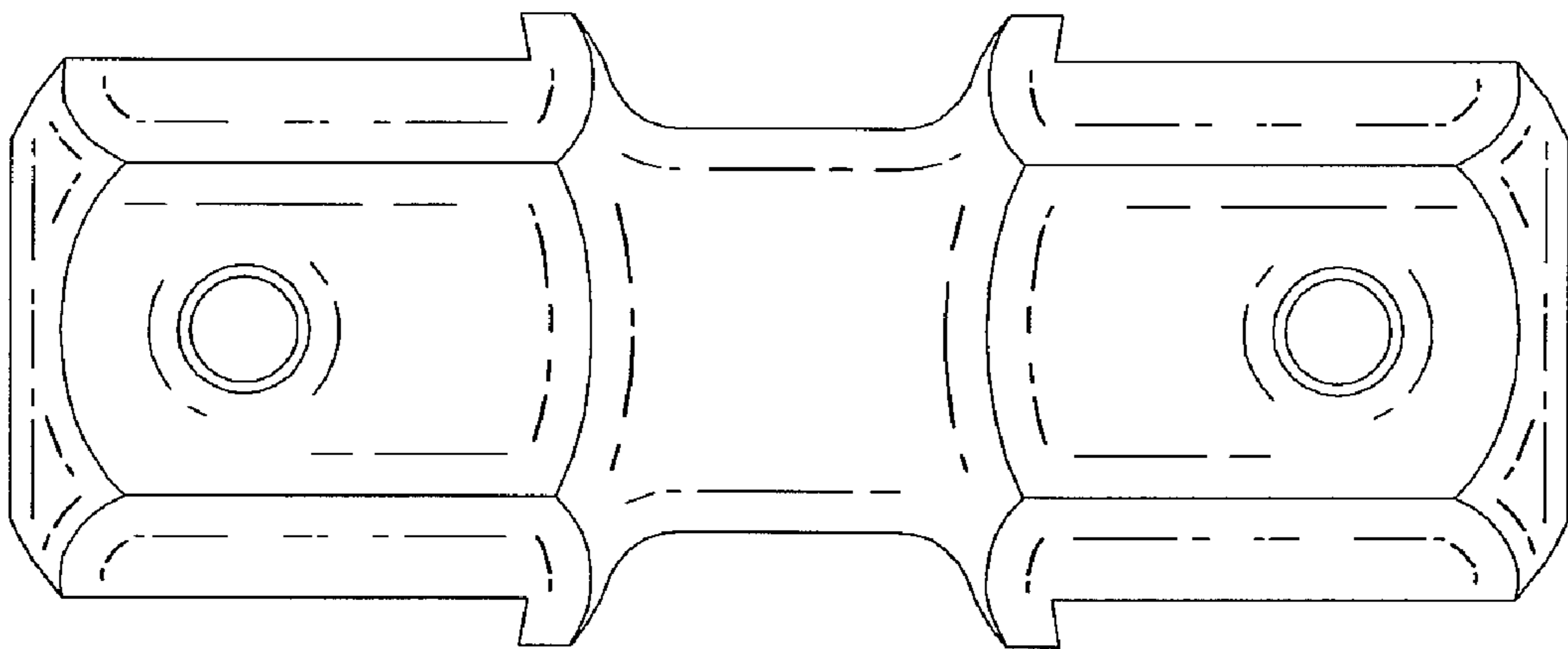

FIG. 7

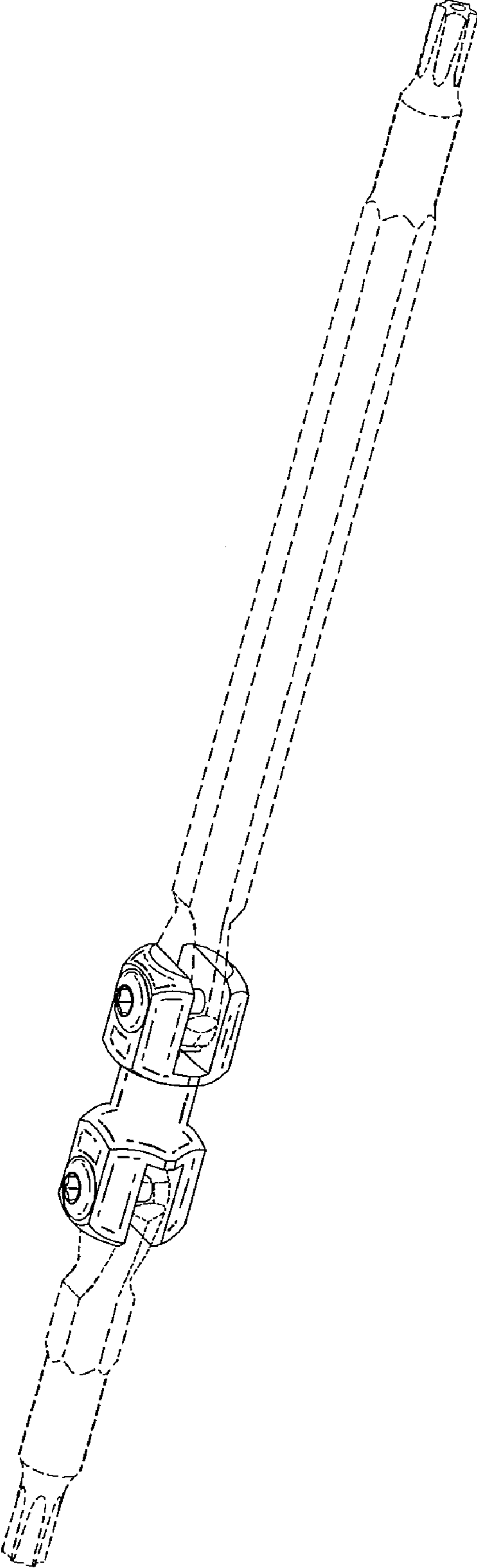

FIG. 8

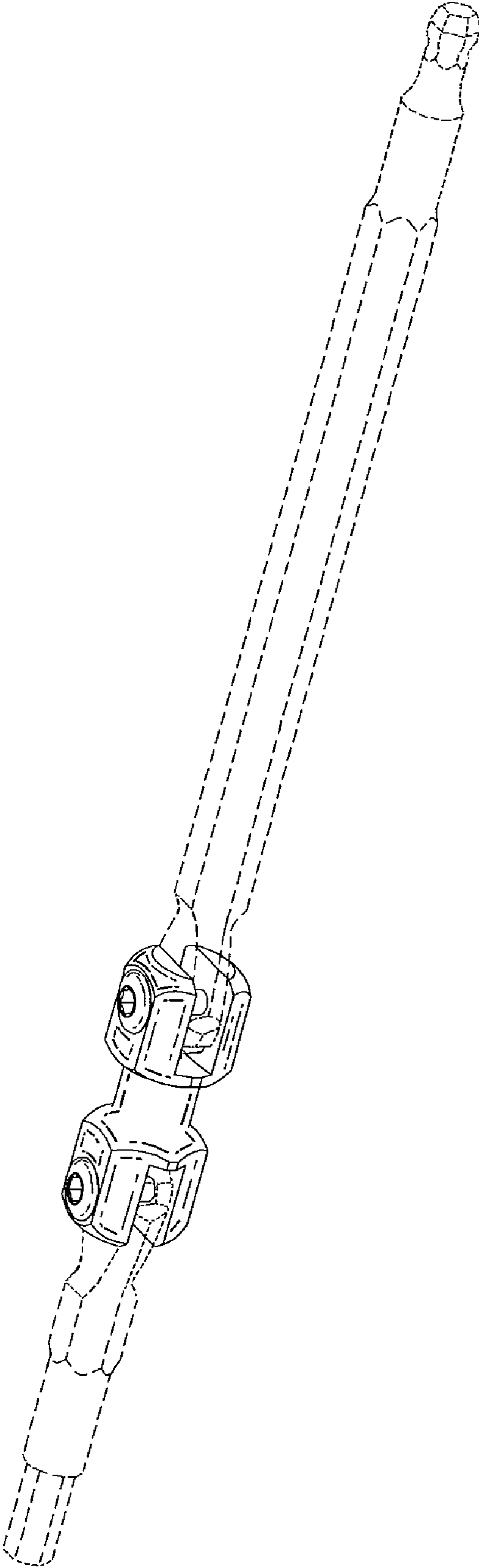

FIG. 9