



US00D670522S

(12) **United States Design Patent**
Cittadino

(10) **Patent No.:** **US D670,522 S**

(45) **Date of Patent:** **** Nov. 13, 2012**

(54) **WALL-MOUNTABLE TOWEL BAR**

(75) Inventor: **Kyle Cittadino**, Wilmington, DE (US)

(73) Assignee: **Zenith Products Corporation**, New Castle, DE (US)

(**) Term: **14 Years**

(21) Appl. No.: **29/397,433**

(22) Filed: **Jul. 15, 2011**

(51) **LOC (9) Cl.** **06-04**

(52) **U.S. Cl.** **D6/549; D6/550**

(58) **Field of Classification Search** D6/518-524,
D6/546-550, 574; D8/300, 370, 315; 108/28-29;
211/13.1, 16, 85.5, 86.01, 87.01, 88.04, 100,
211/105.1, 105.2, 106, 113, 123, 181.1, 182-183;
248/49, 175, 176.1, 200, 201, 205.1, 251,
248/302, 309.1, 315; 242/570, 590, 595-598
See application file for complete search history.

(56) **References Cited**

U.S. PATENT DOCUMENTS

D296,964 S *	8/1988	Jans	D6/548
D427,471 S *	7/2000	Chen	D6/549
D486,337 S *	2/2004	Hoernig	D6/548
D492,530 S *	7/2004	Chen	D6/549
D514,857 S *	2/2006	Hoernig	D6/548
D516,349 S *	3/2006	Ferrer Beltran	D6/549
D563,707 S *	3/2008	Lee	D6/549

* cited by examiner

Primary Examiner — Brian N Vinson

(74) *Attorney, Agent, or Firm* — Panitch Schwarze Belisario & Nadel LLP

(57) **CLAIM**

The ornamental design for a wall-mountable towel bar, as shown and described.

DESCRIPTION

FIG. 1 is a right front perspective view of a wall-mountable towel bar in accordance with my new design;
 FIG. 2 is a front elevational view thereof;
 FIG. 3 is a top plan view thereof, the bottom plan view being identical;
 FIG. 4 is a right side elevational view thereof, a left side elevational view being a mirror image thereof;
 FIG. 5 is enlarged fragmentary view of a portion of the design shown in 1, with the remaining portions omitted from the disclosure merely for clarity of illustration;
 FIG. 6 is enlarged fragmentary view of a portion of the design shown in 2;
 FIG. 7 is enlarged fragmentary view of a portion of the design shown in 3; and,
 FIG. 8 is enlarged fragmentary view of a portion of the design shown in 4.
 The rear elevation view of the wall-mountable towel bar is not shown in the drawings or described in the specification and, therefore, forms no part of the claimed design.

1 Claim, 4 Drawing Sheets

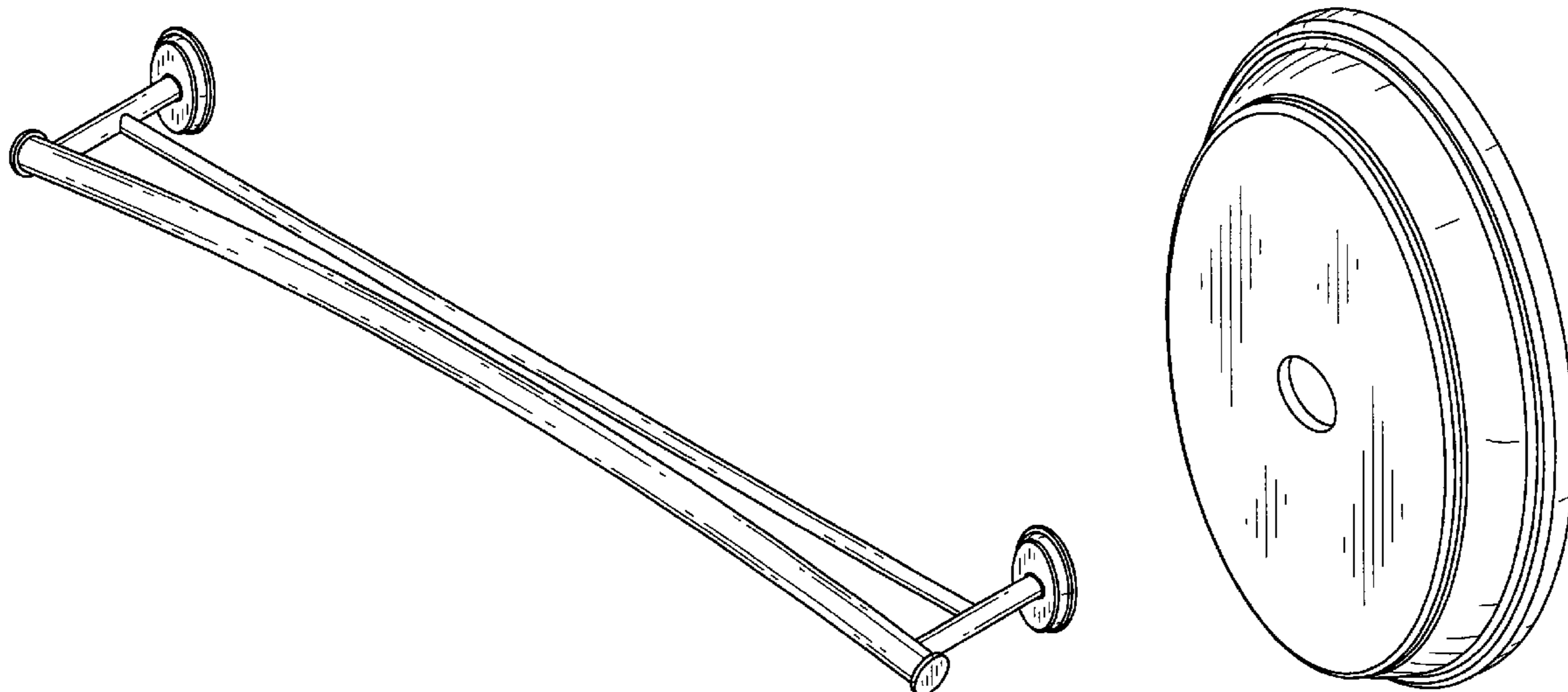

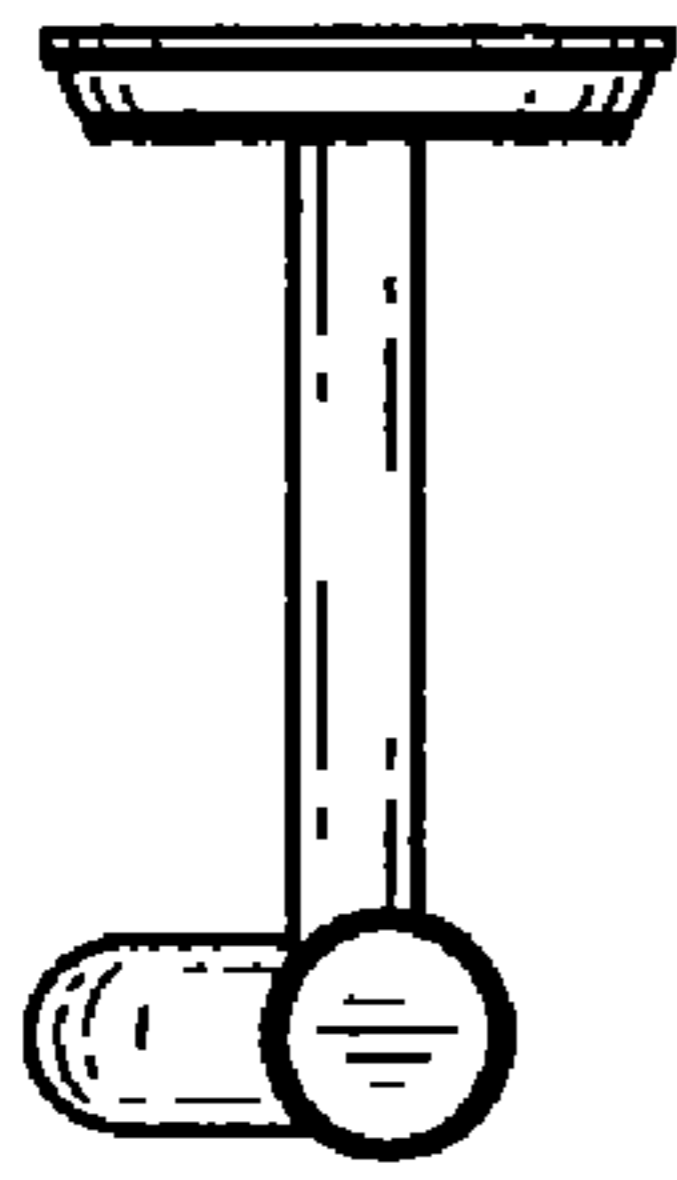

Fig. 4

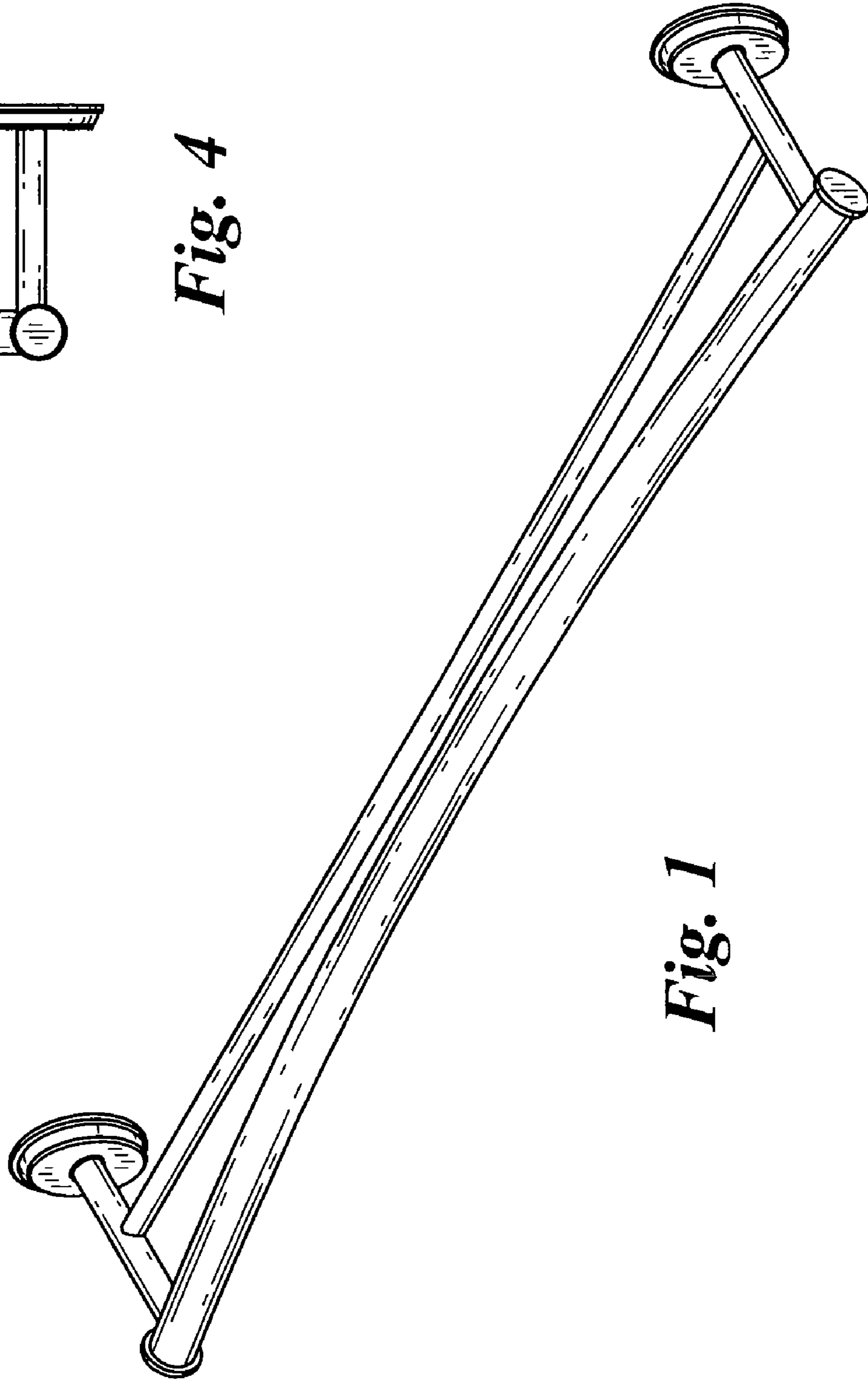

Fig. 1

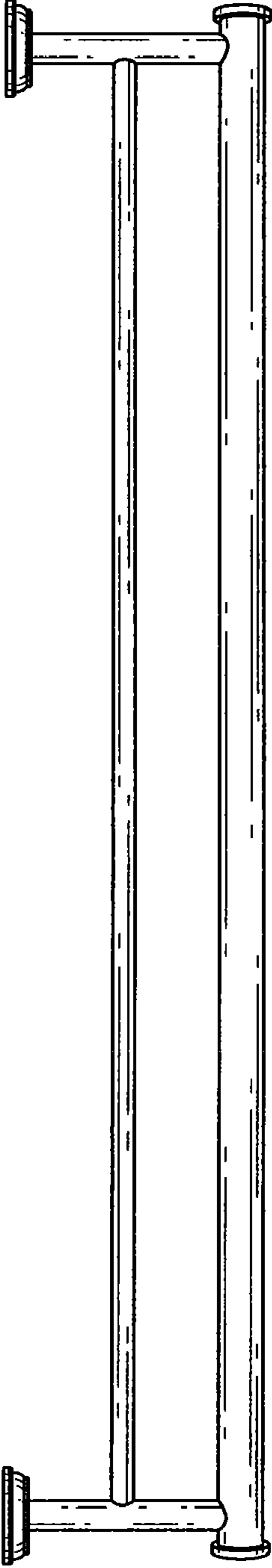

Fig. 3



Fig. 2

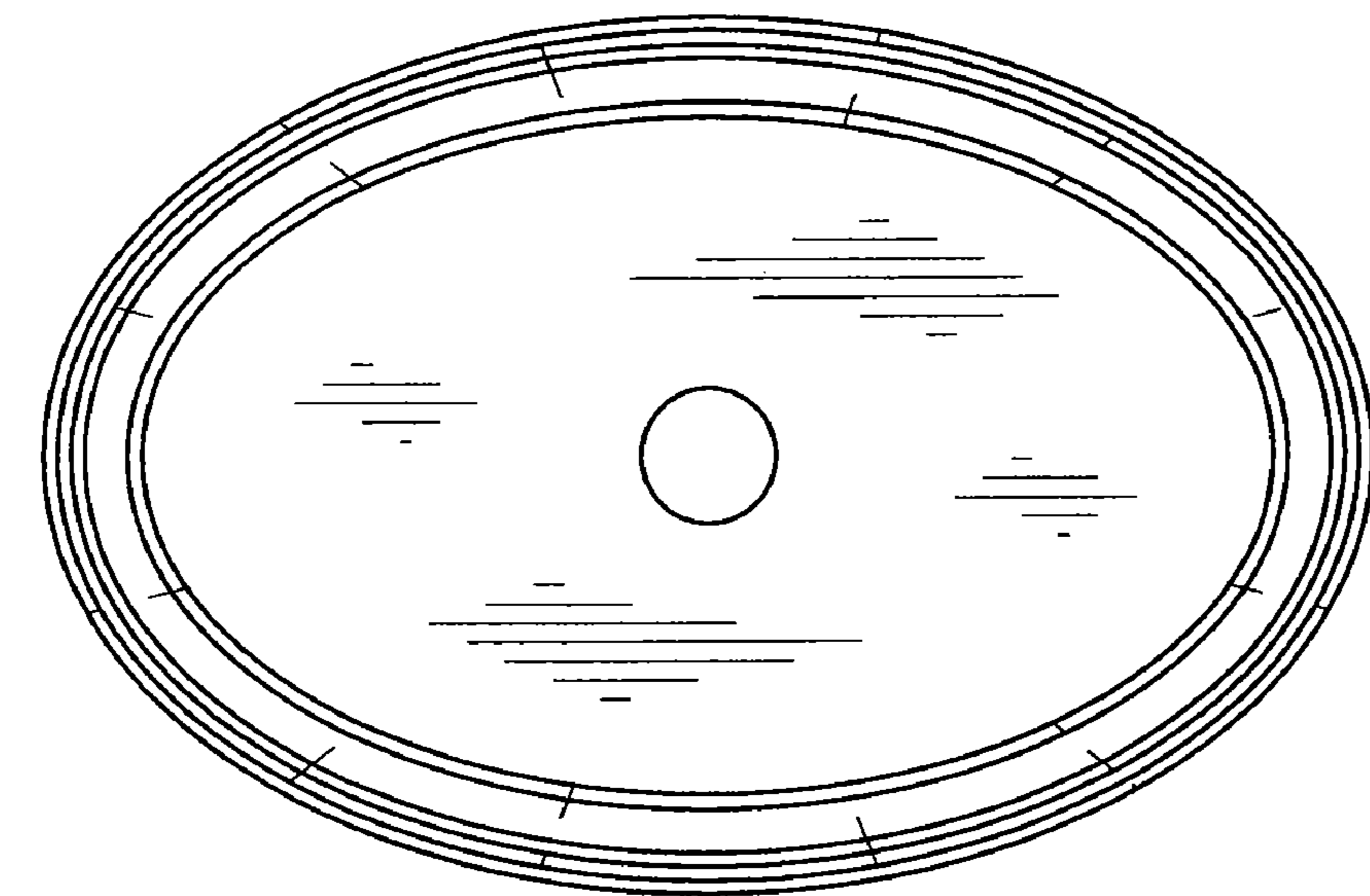

Fig. 5

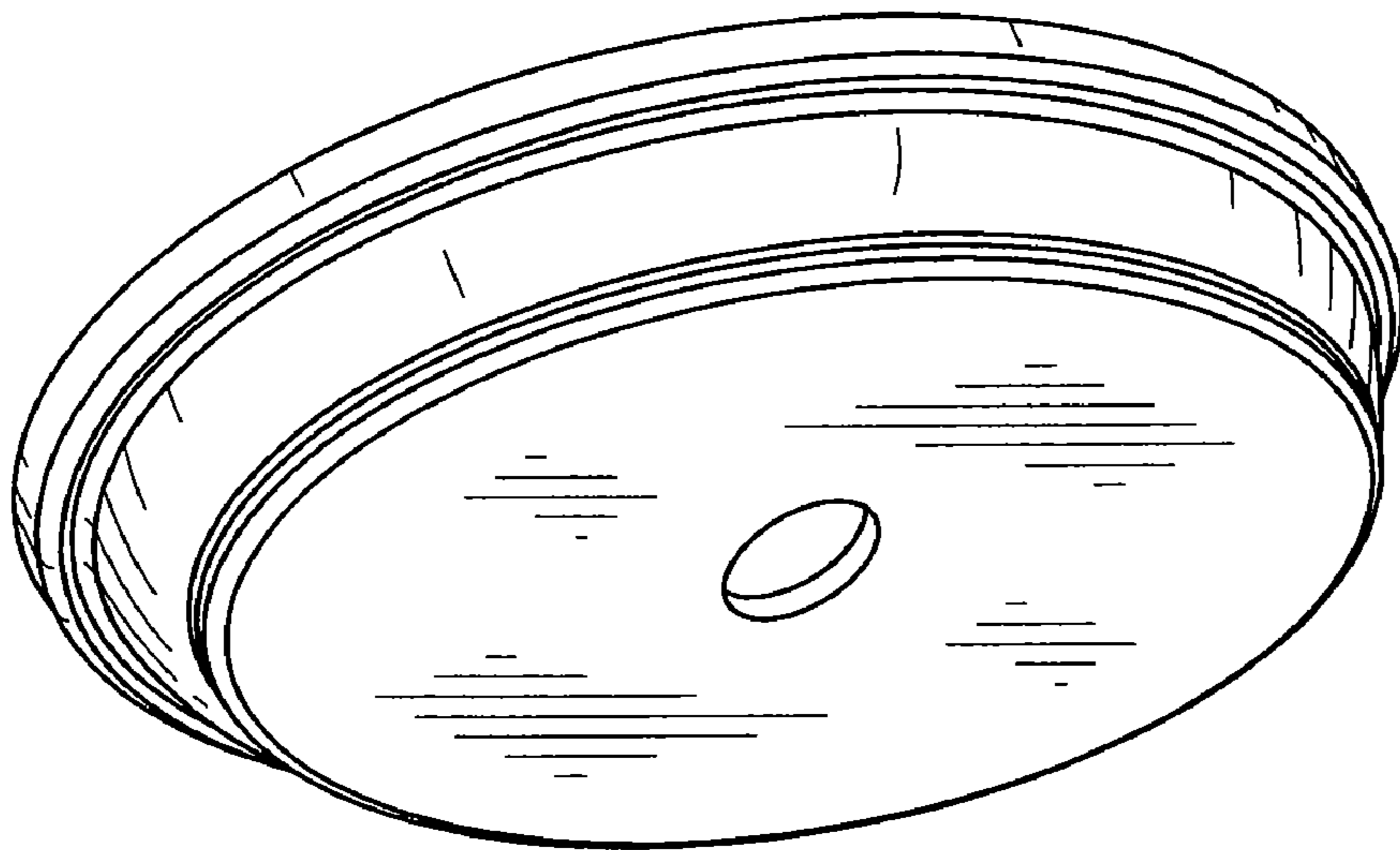

Fig. 6

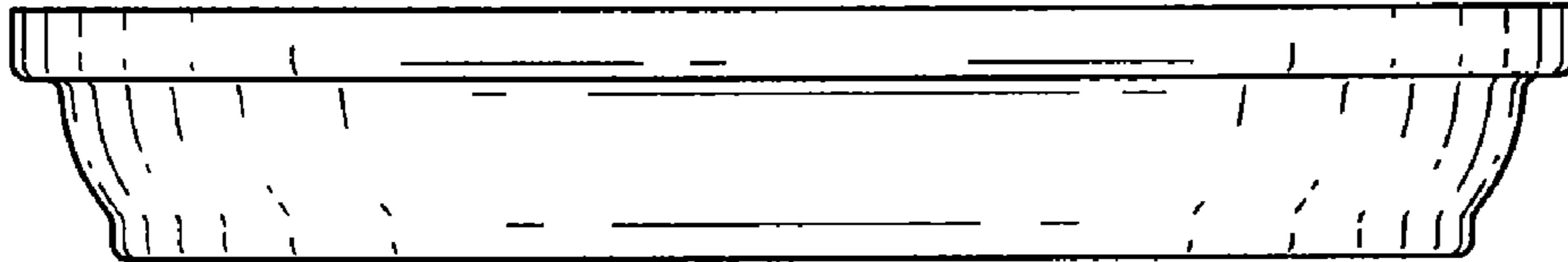

Fig. 8

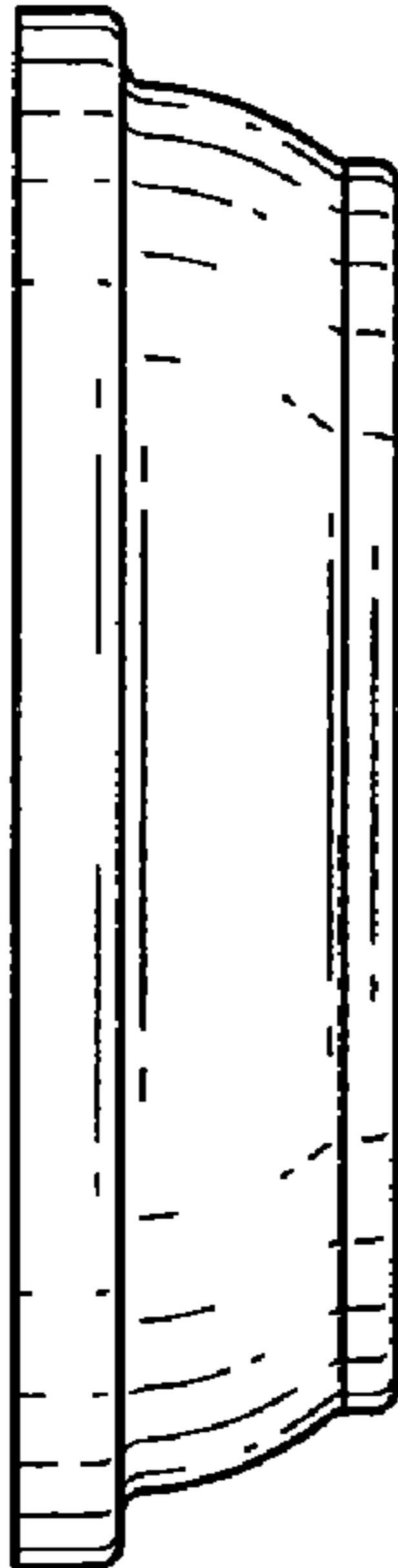

Fig. 7