



US00D670495S

(12) **United States Design Patent**  
**Lorek et al.**

(10) **Patent No.:** **US D670,495 S**

(45) **Date of Patent:** **\*\* Nov. 13, 2012**

(54) **CASE WITH DETACHABLE AUXILIARY CASES**

(75) Inventors: **Patricia Lorek**, Frickenhausen (DE);  
**Rolf Burchia**, Diepoldsau (CH);  
**Manfred Klement**, Nürtingen (DE)

(73) Assignees: **Plaston AG**, Widnau (CH);  
**Metabowerke GmbH**, Nuertingen (DE)

(\*\*) Term: **14 Years**

(21) Appl. No.: **29/389,648**

(22) Filed: **Apr. 14, 2011**

(30) **Foreign Application Priority Data**

Oct. 14, 2010 (EM) ..... 001768342-0001  
Oct. 14, 2010 (EM) ..... 001768342-0002  
Oct. 14, 2010 (EM) ..... 001768342-0003

(51) **LOC (9) Cl.** ..... **03-01**

(52) **U.S. Cl.** ..... **D3/284; D3/295**

(58) **Field of Classification Search** ..... 206/349,  
206/372-379; 220/523-528, 23.4; D3/273,  
D3/276, 280-288, 291-297, 900-905  
See application file for complete search history.

(56) **References Cited**

**U.S. PATENT DOCUMENTS**

5,429,235 A 7/1995 Chen  
5,826,718 A 10/1998 Ahern, Jr. et al.  
5,833,065 A 11/1998 Burgess  
6,062,385 A \* 5/2000 Cho ..... 206/373  
6,533,138 B2 \* 3/2003 Chwen-Ru ..... 220/522  
6,612,435 B1 9/2003 Chang  
7,159,712 B1 1/2007 Chen  
7,334,680 B2 2/2008 Cunningham et al.  
D639,557 S \* 6/2011 Damda ..... D3/287

**FOREIGN PATENT DOCUMENTS**

DE 8716022 U1 1/1988  
DE 94 17 348.6 U1 2/1995  
DE 693 11 446 T2 10/1997  
DE 298 23 041.0 U1 5/1999  
DE 203 03 536 U1 7/2003

DE 10 2005 062 997 A1 7/2007  
DE 20 2010 014 027 U1 2/2011  
EP 1 563 965 A1 8/2005  
FR 1 417 790 A 11/1965  
GB 2 365 415 A 2/2002

\* cited by examiner

*Primary Examiner* — Jennifer Rivard

(74) *Attorney, Agent, or Firm* — GrayRobinson, PA

(57) **CLAIM**

The ornamental design for a case with detachable auxiliary cases, as shown and described.

**DESCRIPTION**

FIG. 1 is a first perspective view of a first preferred embodiment which includes a main body, a right auxiliary case detachably attached to the right side of the main body and a left auxiliary case detachably attached to the left side of the main body, the main body, the left auxiliary case and the right auxiliary case all being shown in a closed condition;

FIG. 2 is a second perspective view of the embodiment of FIG. 1 shown with the main body and the left auxiliary case each opened and with the right auxiliary case detached from the main body;

FIG. 3 is a third perspective view of the embodiment of FIG. 1 shown with the main body and the left auxiliary case each closed and with the right auxiliary case detached from the main body;

FIG. 4 is a fourth perspective view showing a portion of the embodiment of FIG. 1 from which the right auxiliary case has been removed entirely and showing the main body and the left auxiliary case both in a closed condition;

FIG. 5 is a fifth perspective view showing the same portion of the embodiment of FIG. 1 as described in connection with FIG. 4 except shown from a generally topward perspective and with the left auxiliary case shown in an open condition;

FIG. 6 is a sixth perspective view showing the embodiment of FIG. 1 from a substantially topward perspective, the main body, the left auxiliary case in the right auxiliary case all being shown in a closed condition;

FIG. 7 is bottom plan view of the embodiment of FIG. 1 shown with the right and left auxiliary cases each attached to the main body;

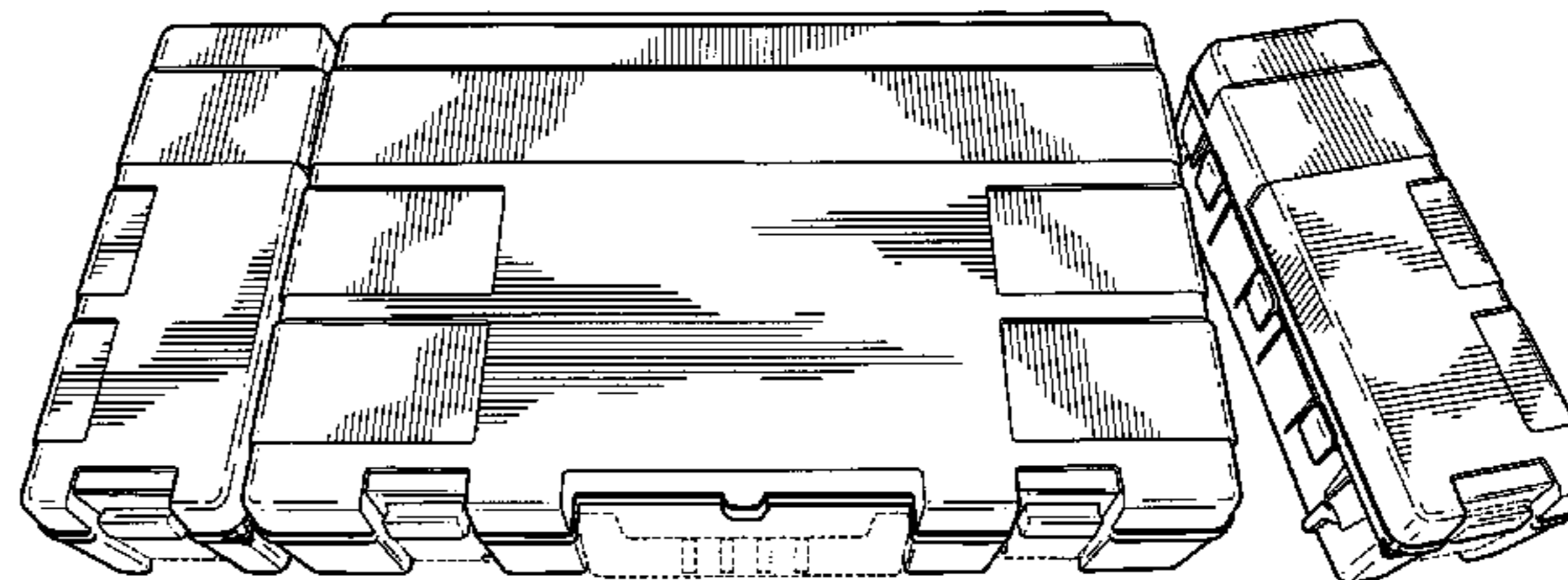
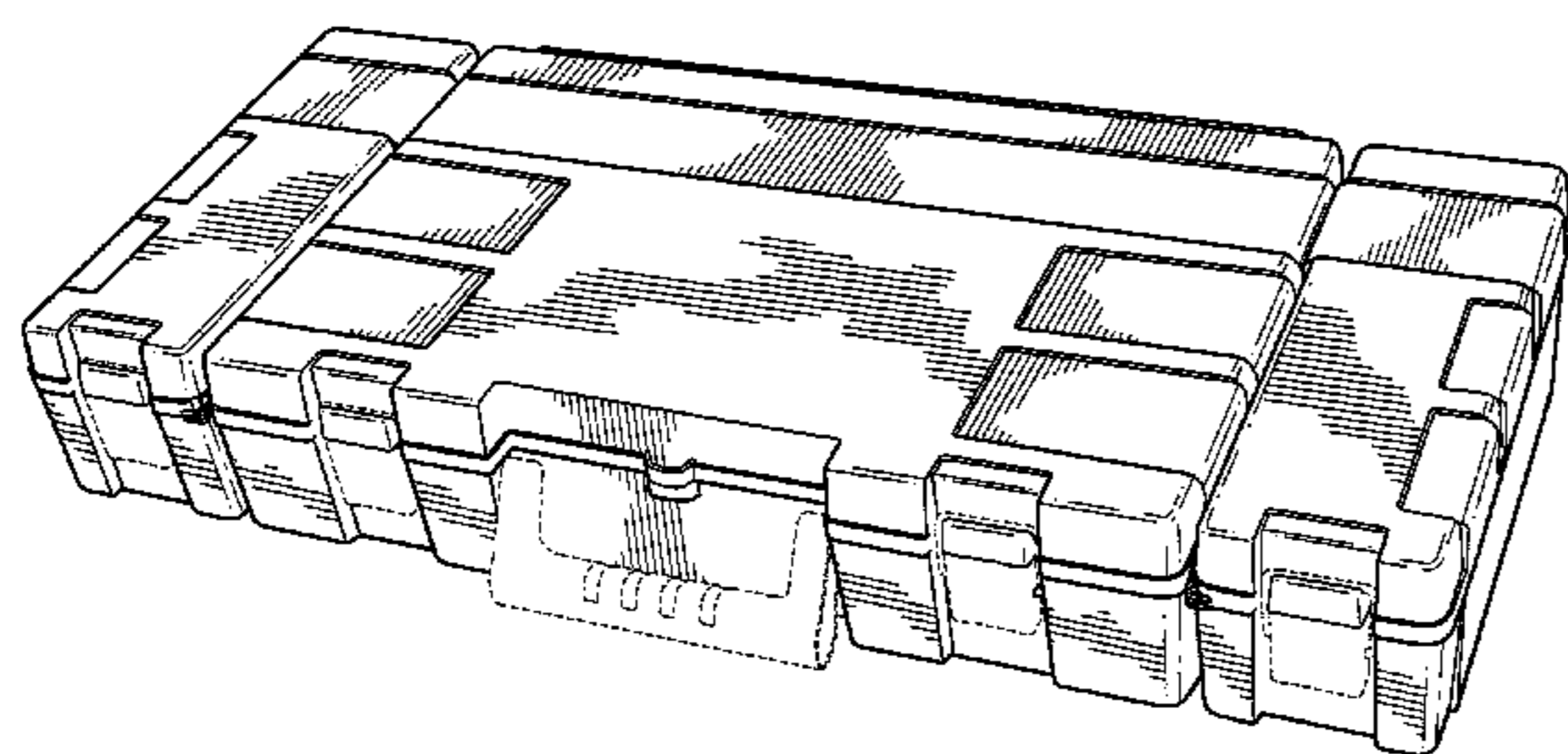

FIG. 8 is a perspective view of the main body of the embodiment of FIG. 1 shown in a closed condition and without either the right auxiliary case and/or the left auxiliary case attached to the main body;

FIG. 9 is a perspective view of the main body of the embodiment of FIG. 1 shown in an open condition and without either the right auxiliary case and/or the left auxiliary case attached to the main body;

FIG. 10 is a perspective view of the main body of the embodiment of FIG. 1 shown in a closed condition from a generally topward perspective and without either the right auxiliary case and/or the left auxiliary case attached to the main body;

FIG. 11 is a perspective view of the main body of the embodiment of FIG. 1 shown in a closed condition from a generally left sideward perspective and without either the right auxiliary case and/or the left auxiliary case attached to the main body;

FIG. 12 is a bottom plan view of the main body of the embodiment of FIG. 1 shown in a closed condition from a generally left sideward perspective and without either the right auxiliary case and/or the left auxiliary case attached to the main body;

FIG. 13 is a perspective view of the main body of the embodiment of FIG. 1 shown in a closed condition from a generally

rearward perspective and without either the right auxiliary case and/or the left auxiliary case attached to the main body; FIG. 14 is a right side elevational view of the right auxiliary case of the embodiment of FIG. 1;

FIG. 15 is a perspective view of the right auxiliary case of the embodiment of FIG. 1 shown in a closed condition;

FIG. 16 is a perspective view of the right auxiliary case of the embodiment of FIG. 1 shown in an open condition;

FIG. 17 is a perspective view of the right auxiliary case of the embodiment of FIG. 1 shown from a generally left sideward perspective and in a closed condition;

FIG. 18 is a perspective view of the right auxiliary case of the embodiment of FIG. 1 shown from a generally right sideward perspective and in a closed condition;

FIG. 19 is a perspective view of the right auxiliary case of the embodiment of FIG. 1 shown from a generally right sideward perspective and in a closed condition;

FIG. 20 is a rear elevational view of the right auxiliary case of the embodiment of FIG. 1 shown a closed condition; and,

FIG. 21 is a substantially bottom plan view of the right auxiliary case of the embodiment of FIG. 1.

The broken lines shown in the drawings illustrate portions of the article and form no part of the claimed design.

**1 Claim, 21 Drawing Sheets**

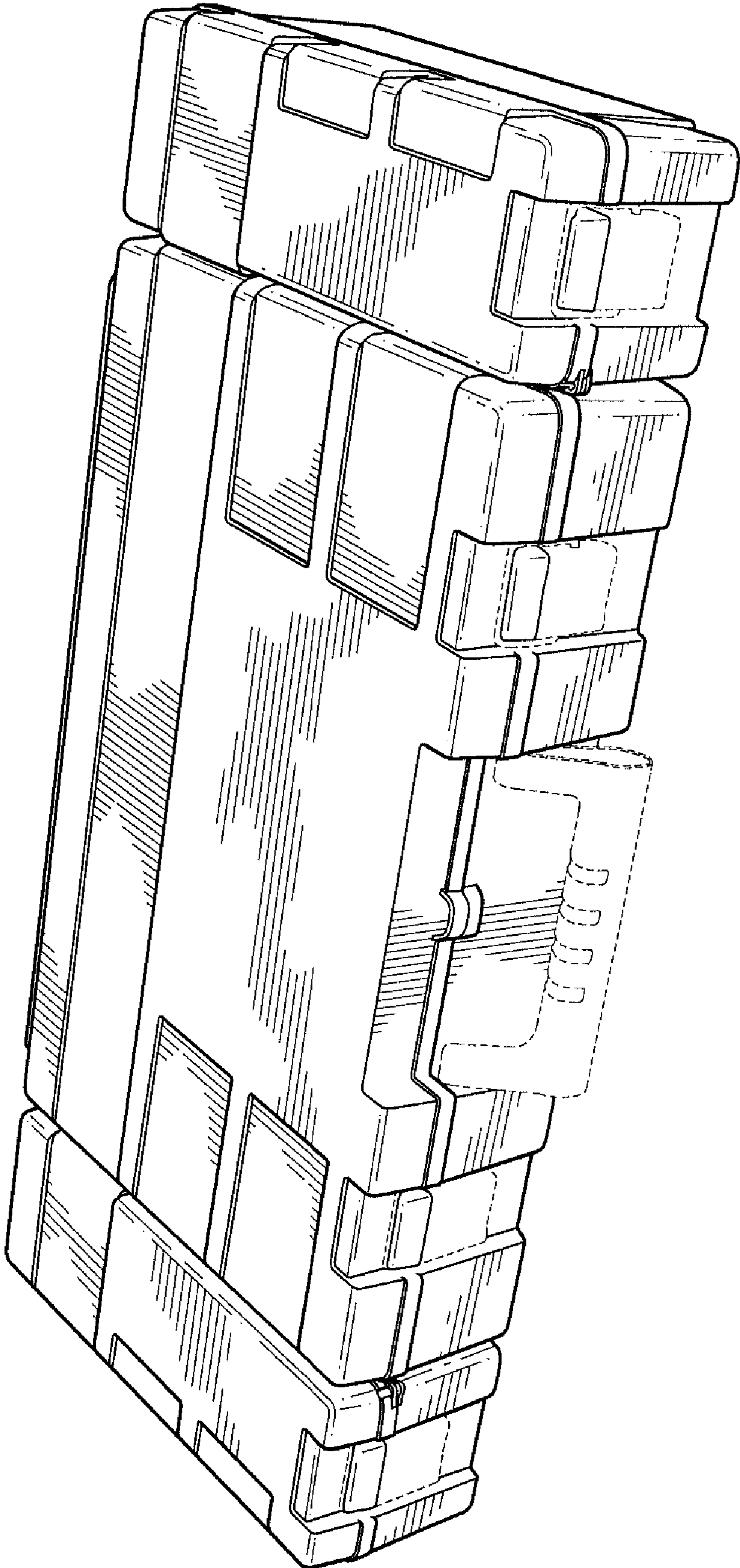

FIG. 1

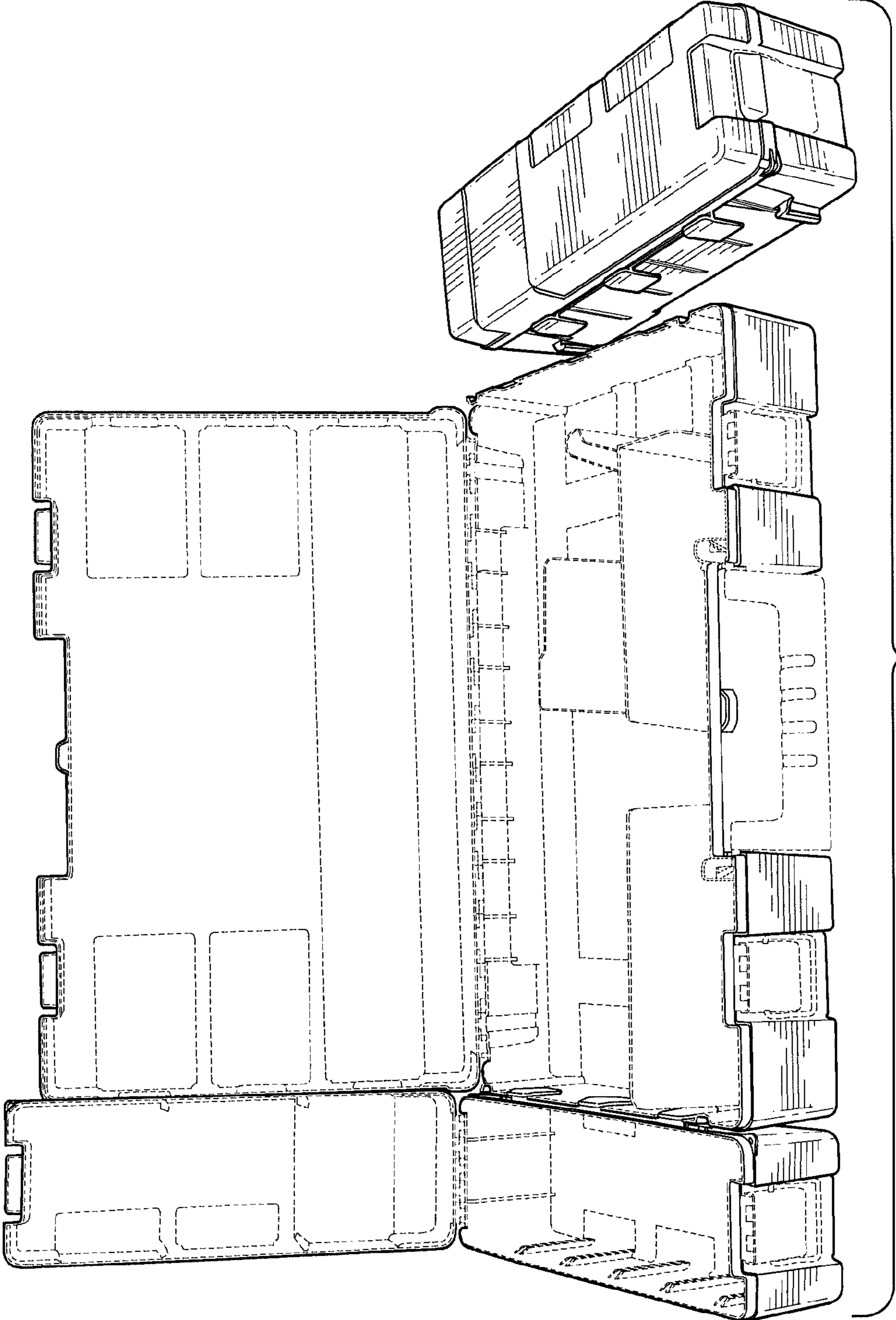

FIG. 2

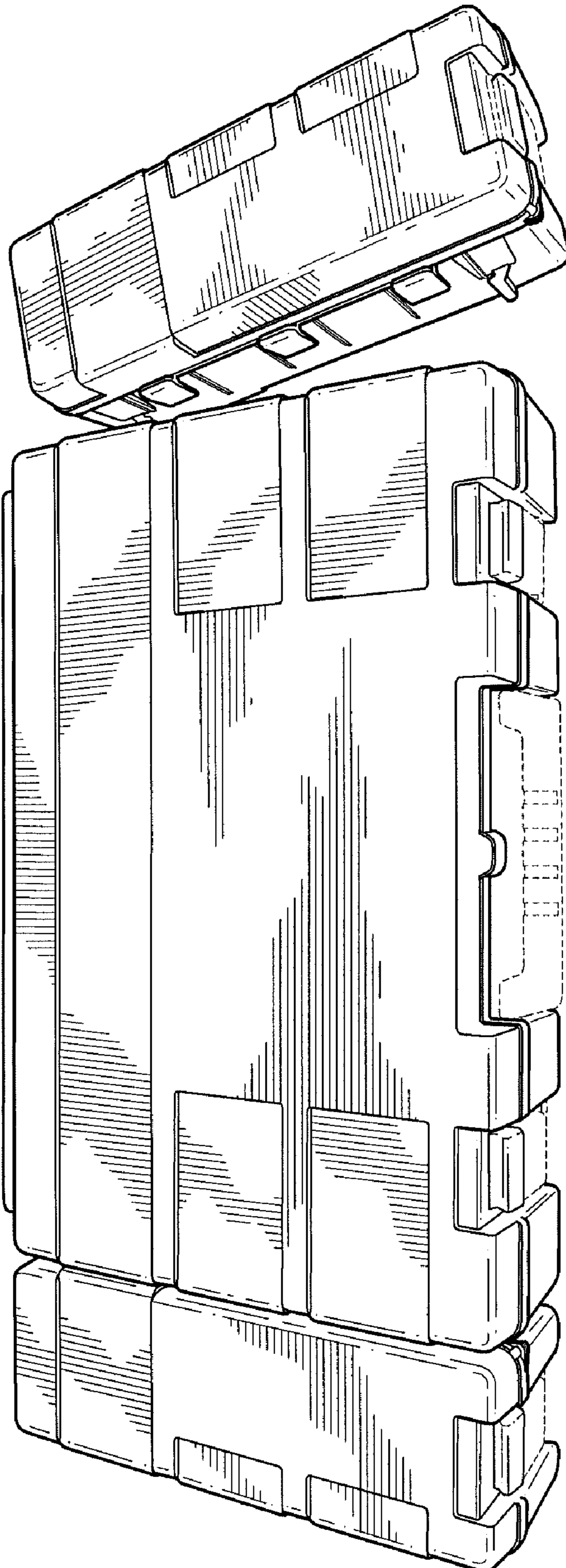

FIG. 3

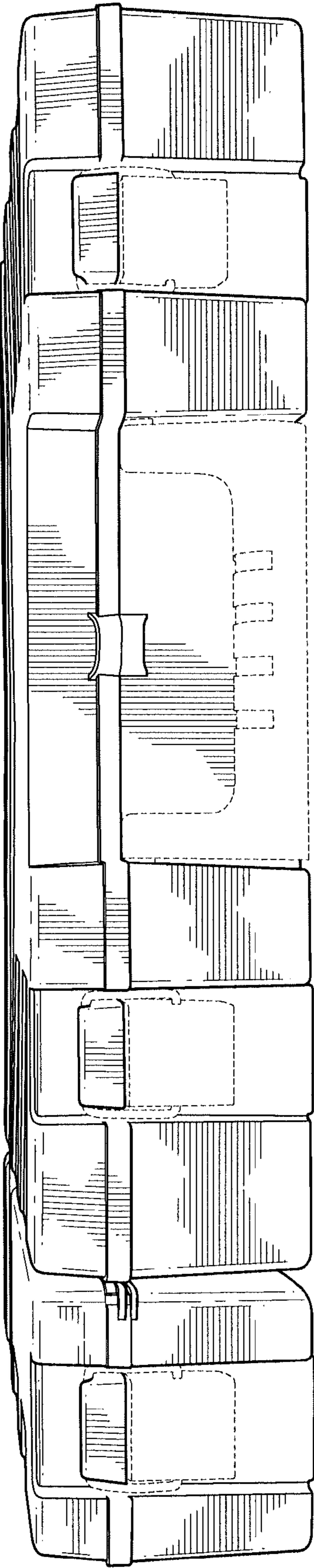

FIG.4

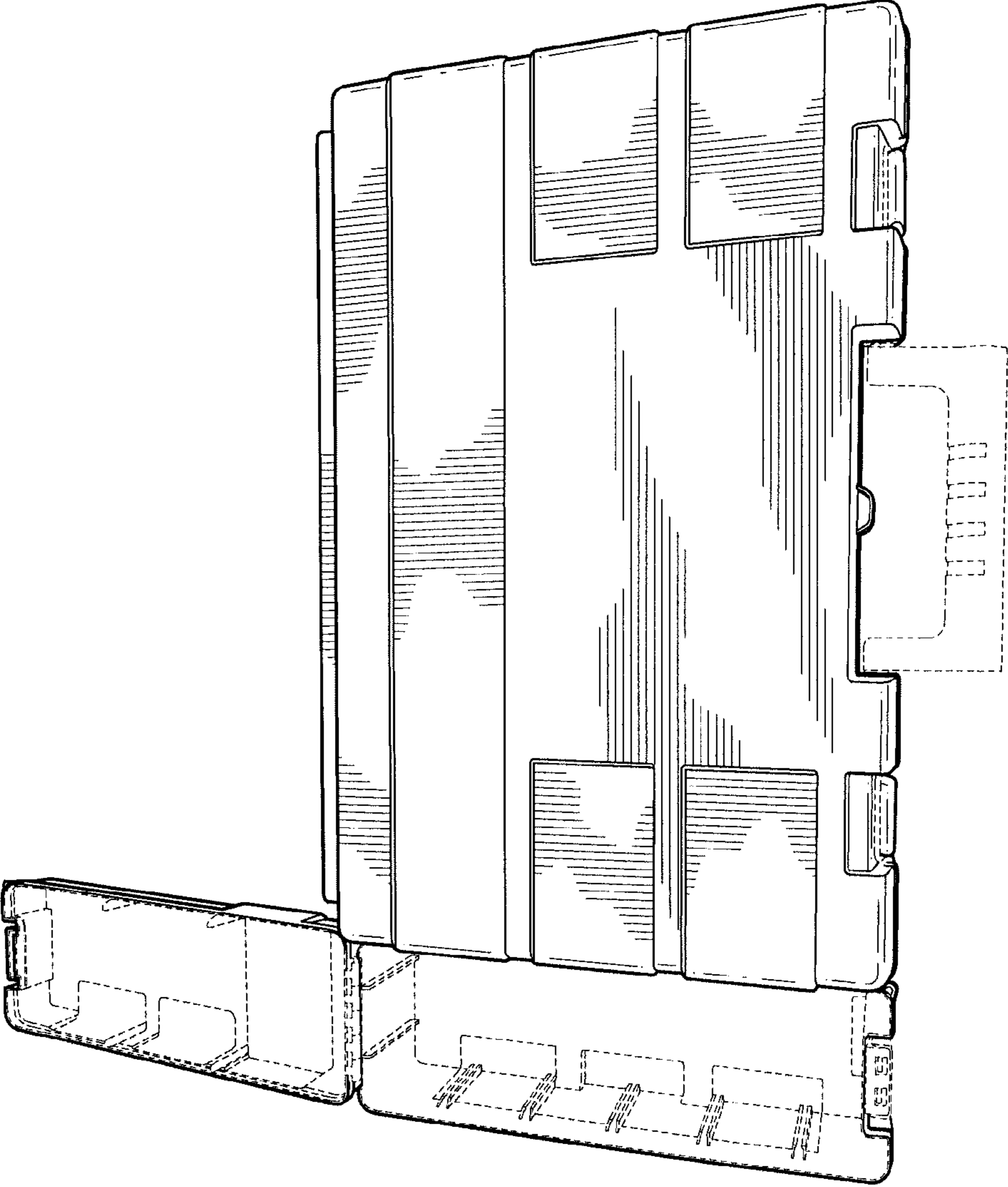

FIG. 5

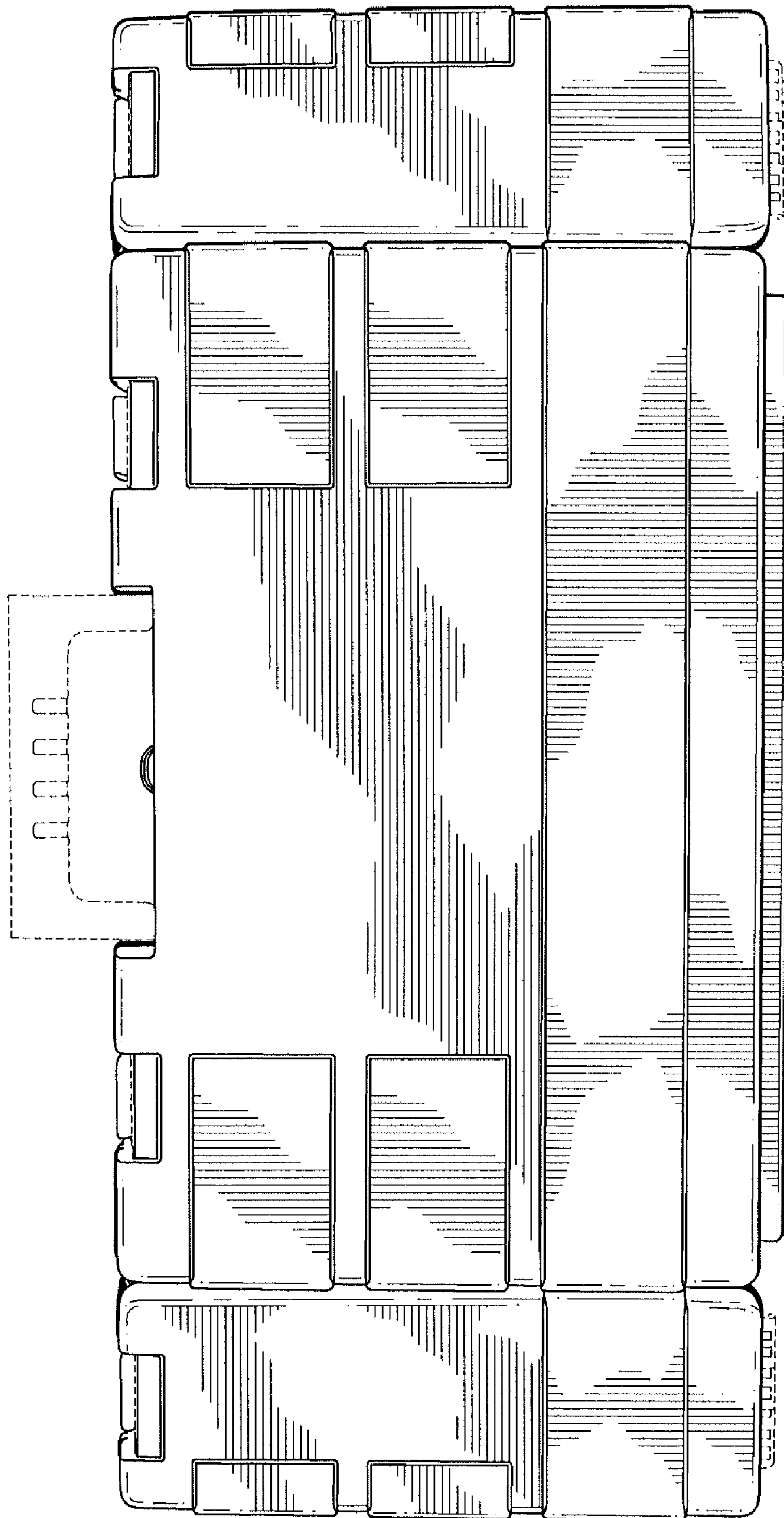

FIG. 6



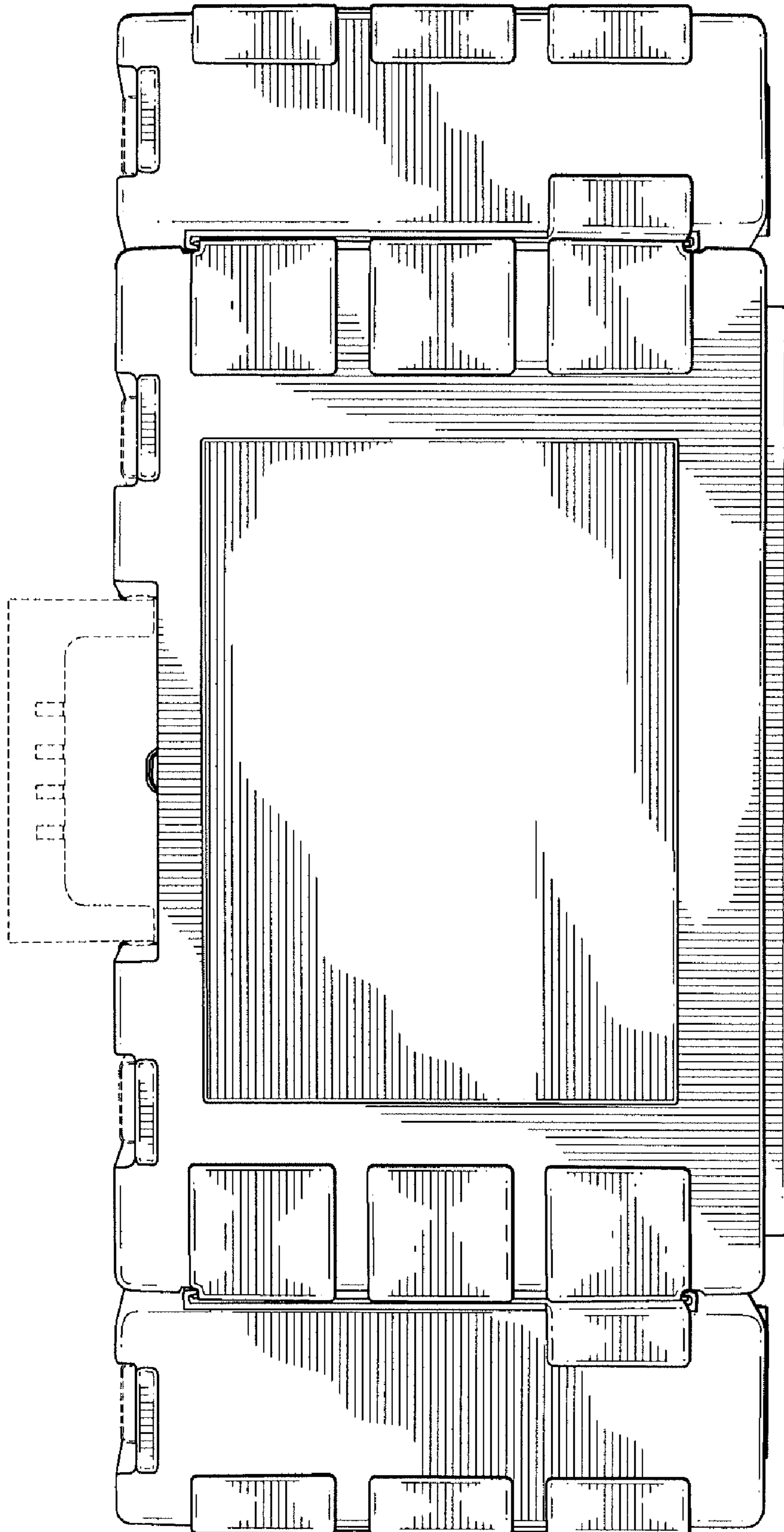

FIG. 7

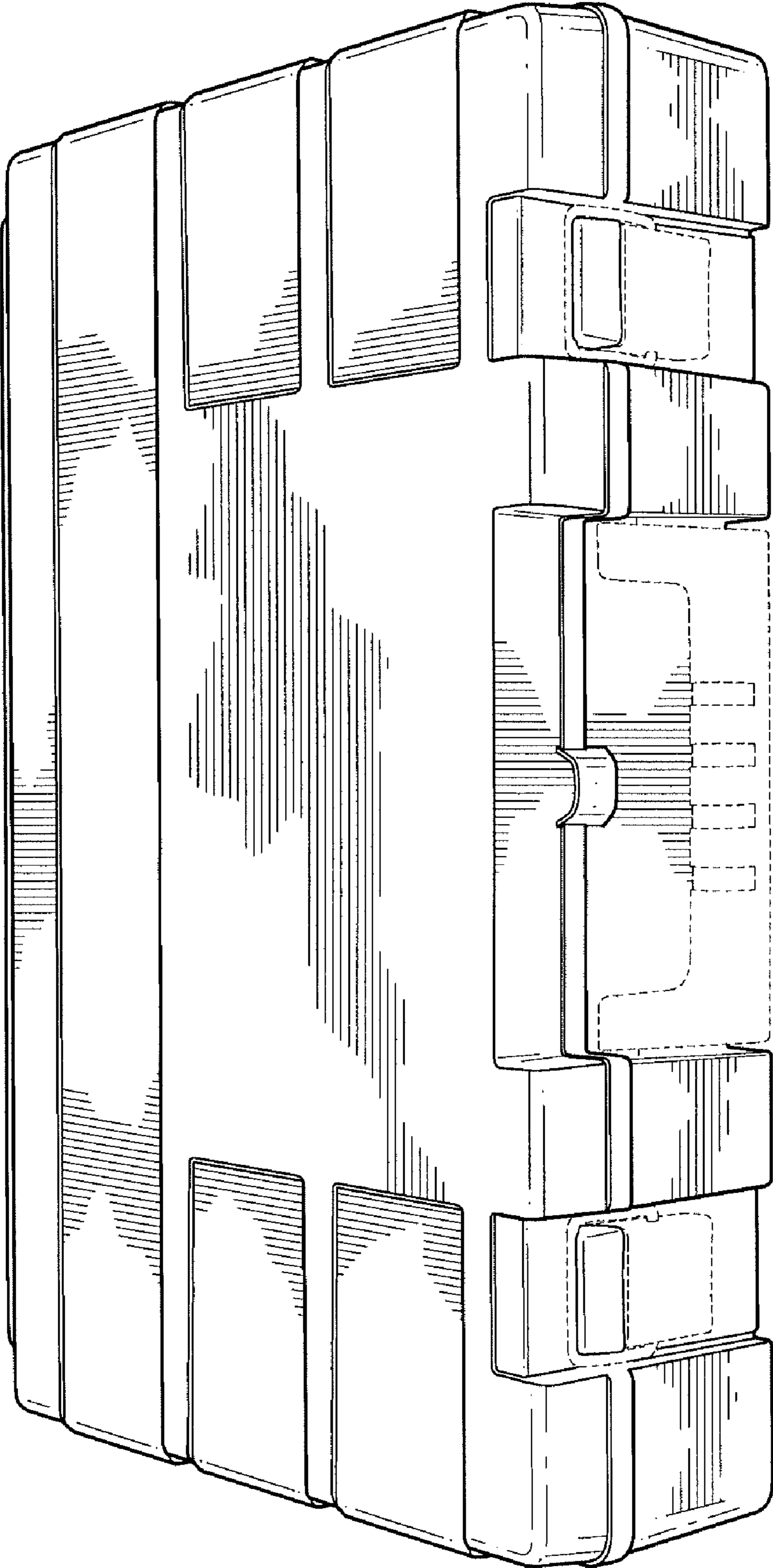

FIG. 8

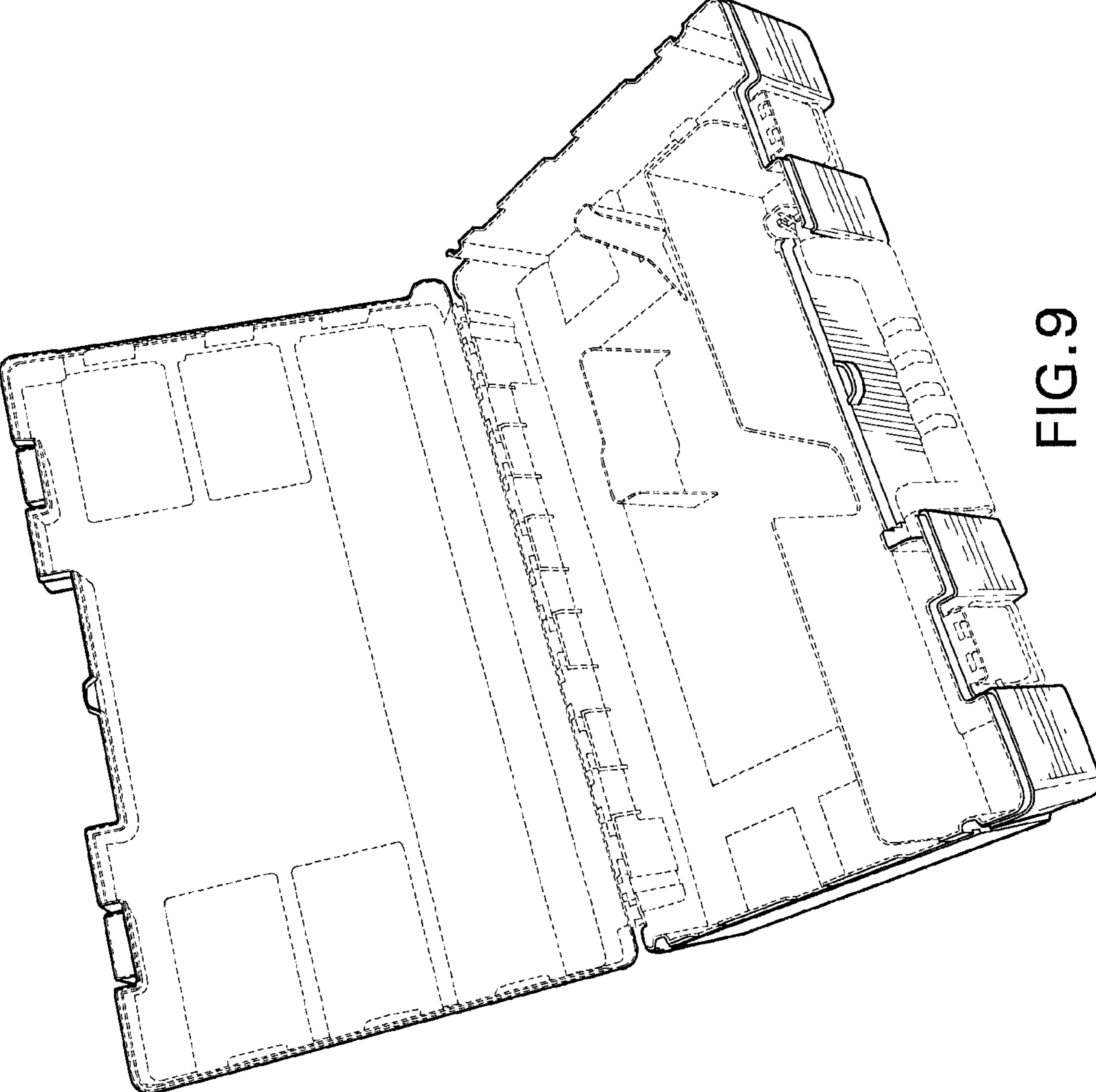

FIG. 9

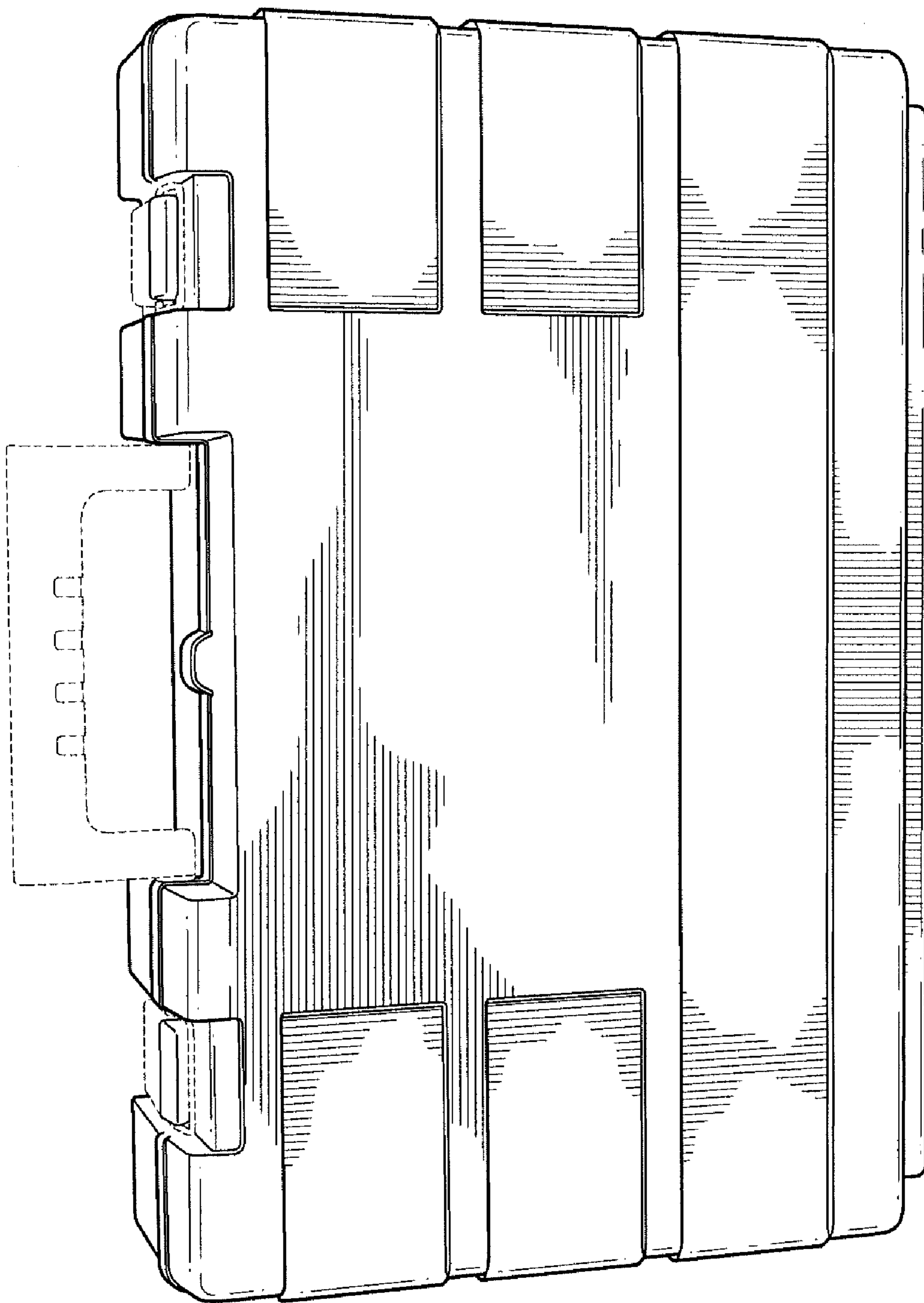

FIG. 10

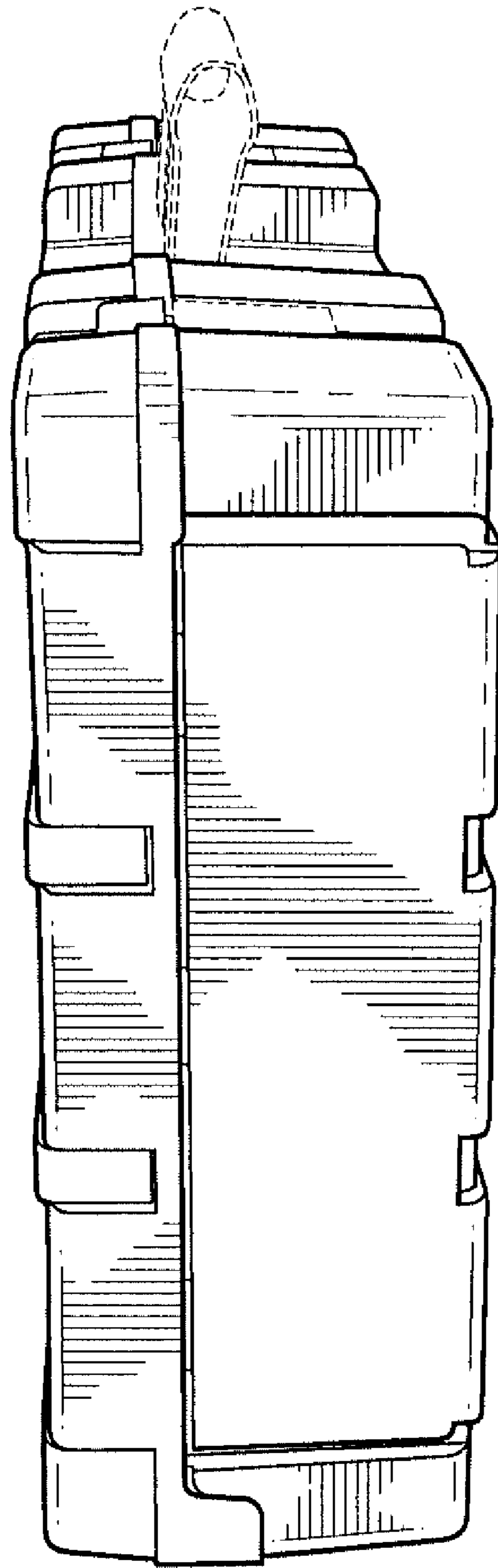

FIG. 11

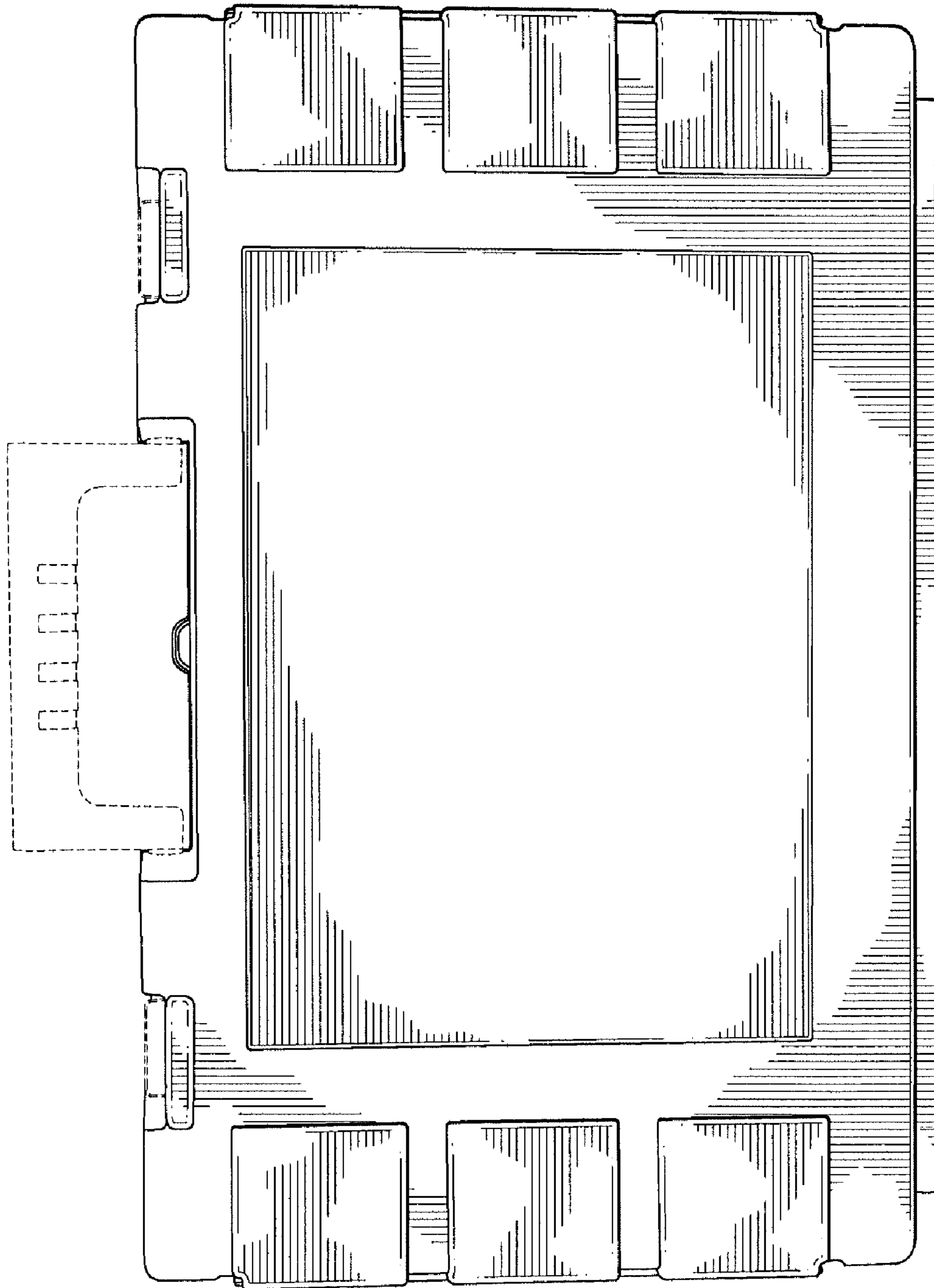

FIG.12

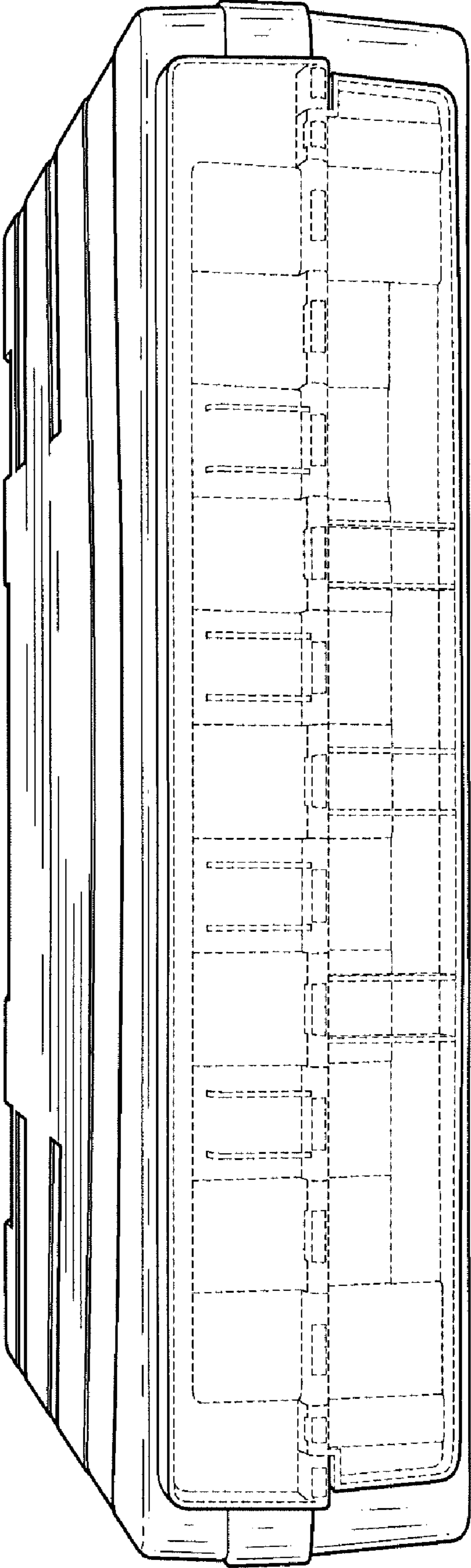

FIG. 13

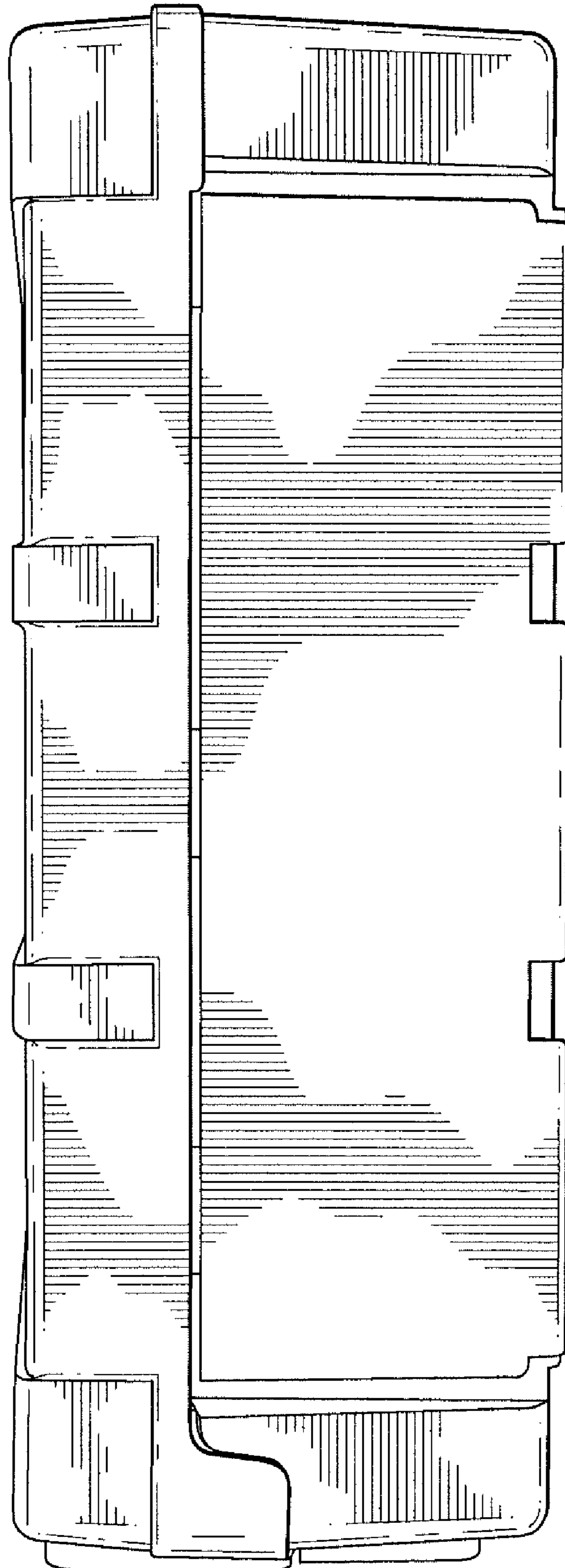

FIG. 14



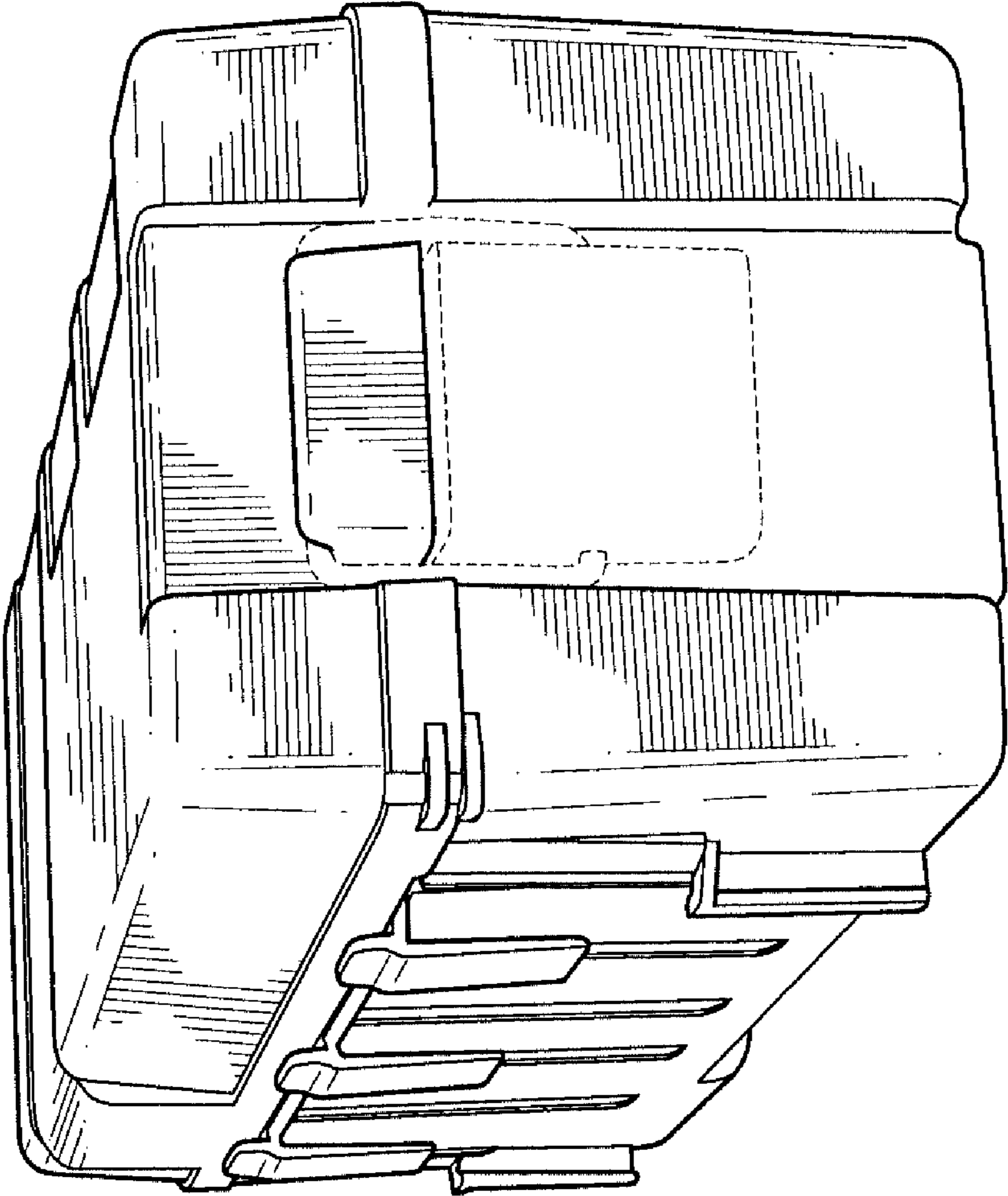

FIG. 15

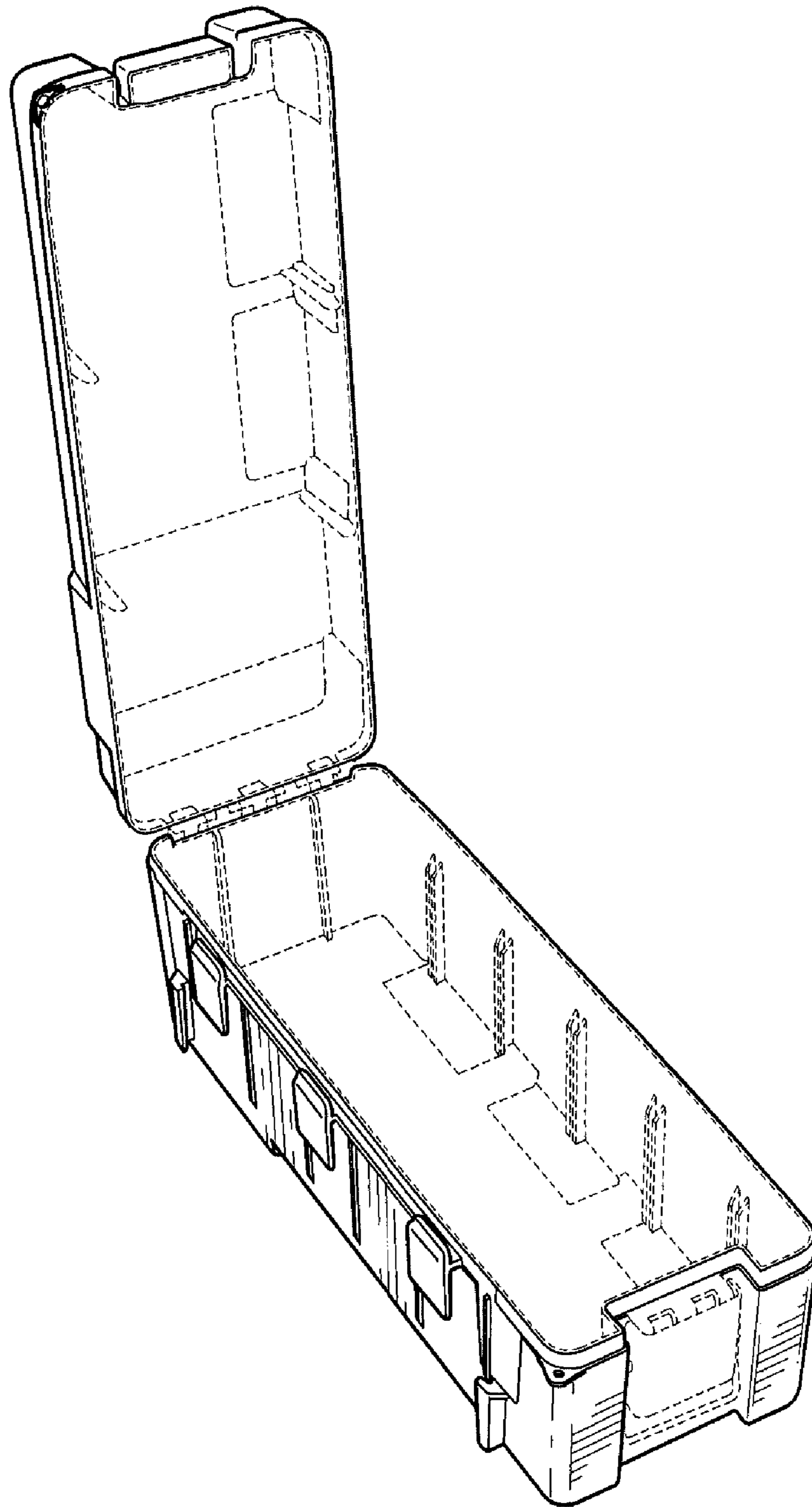

FIG. 16

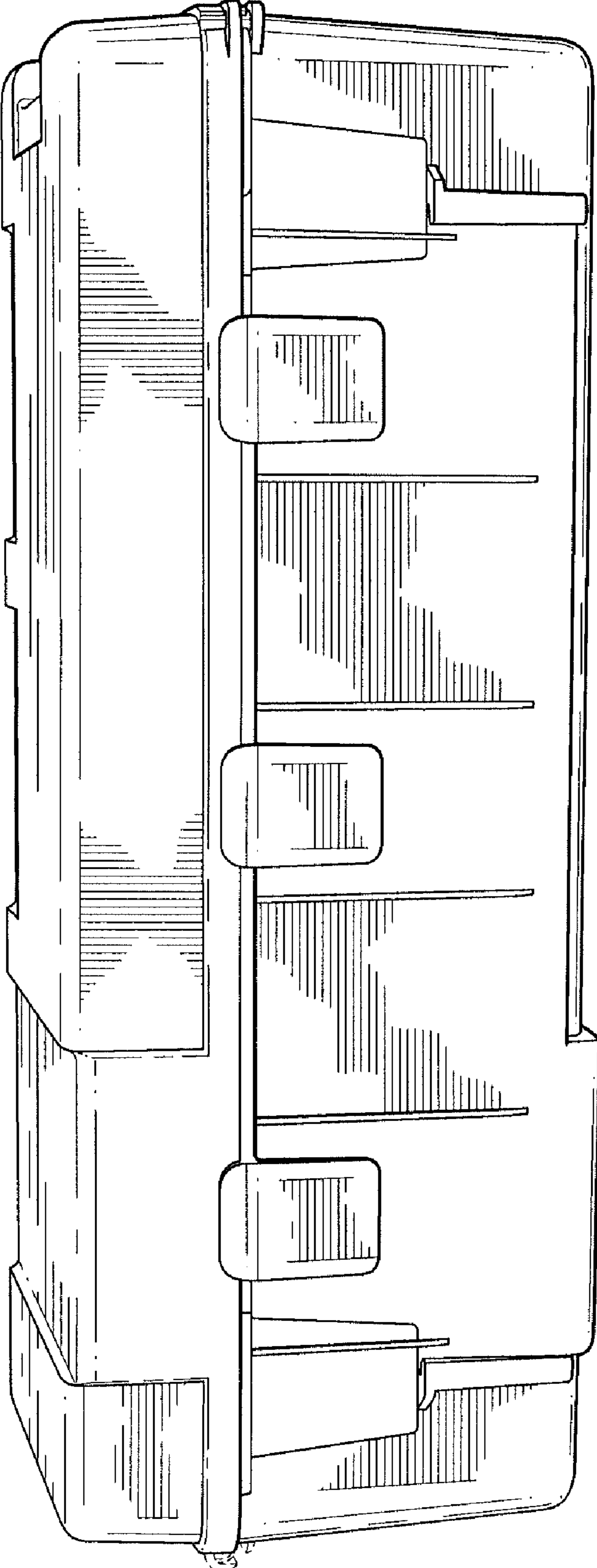

FIG.17

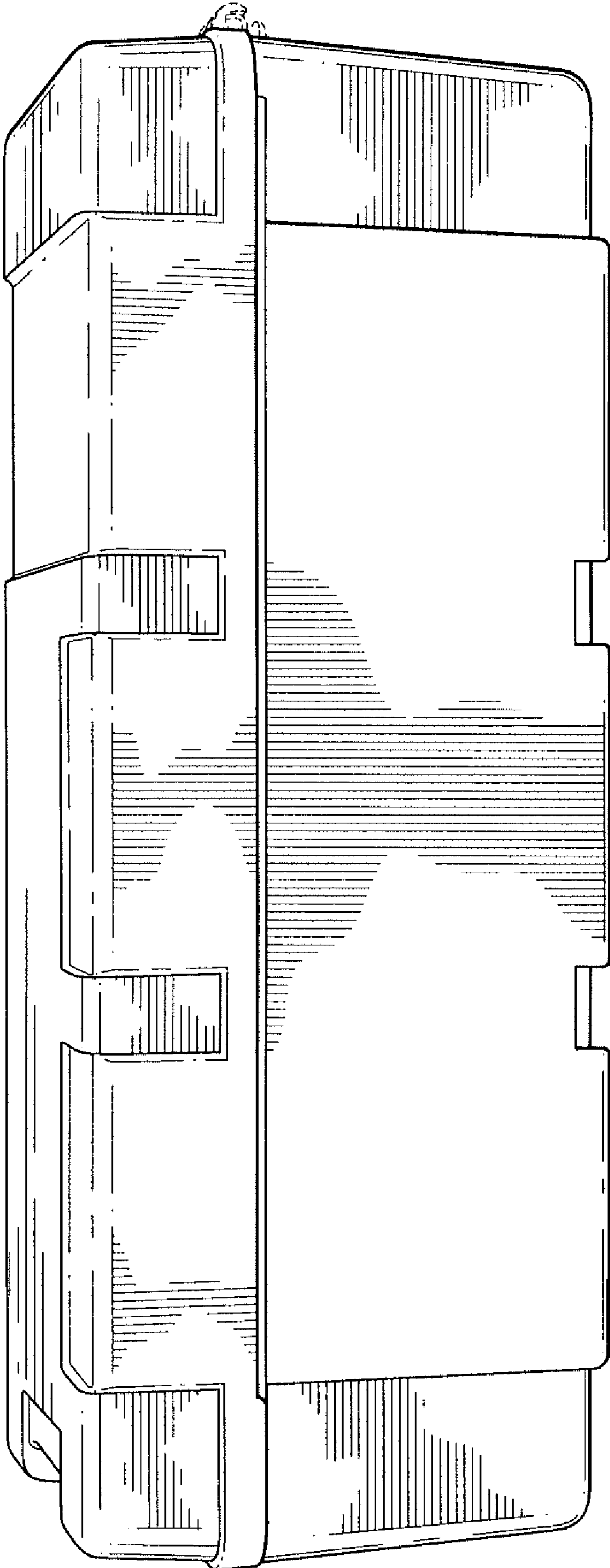

FIG. 18



FIG. 19

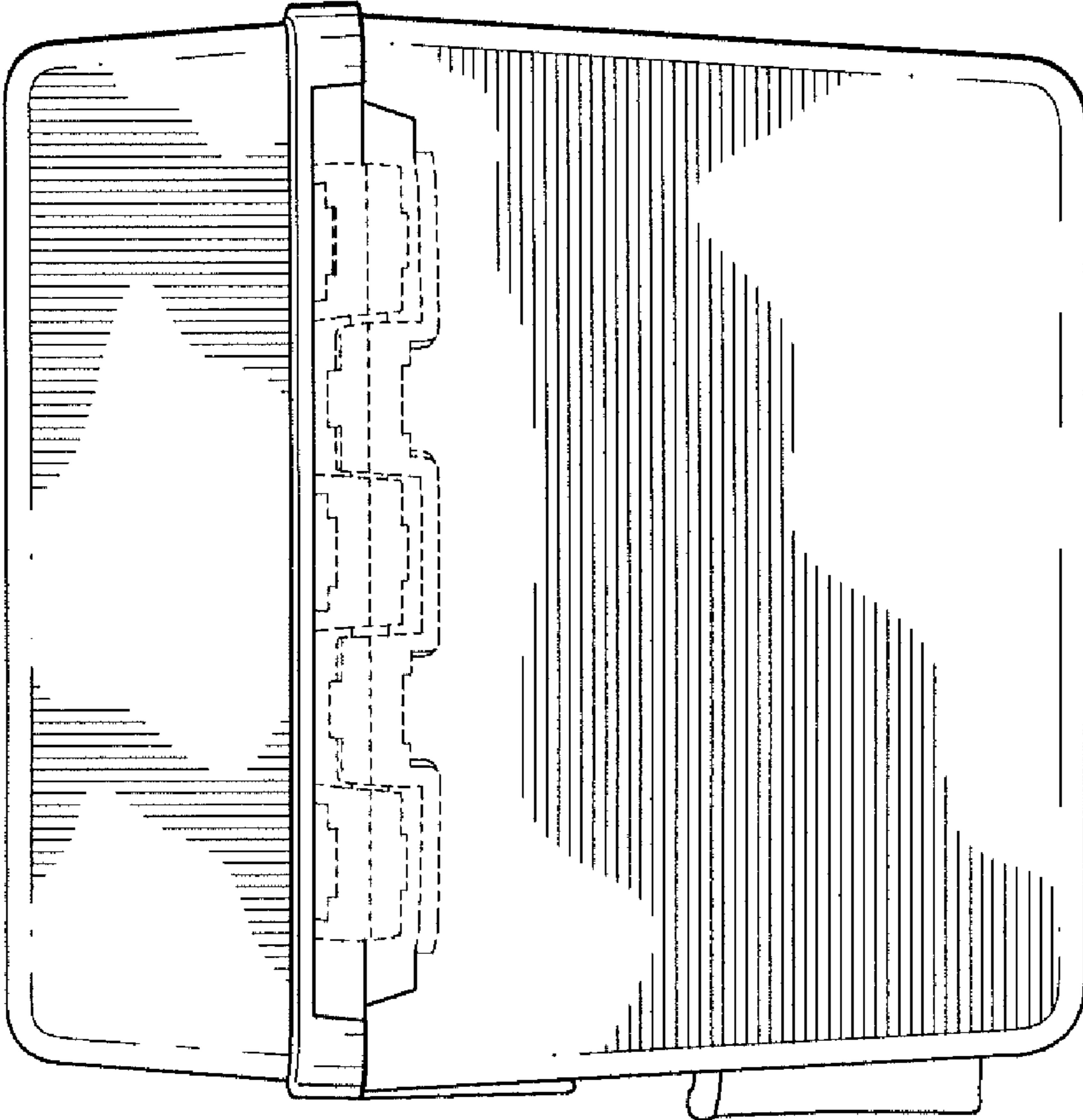

FIG. 20

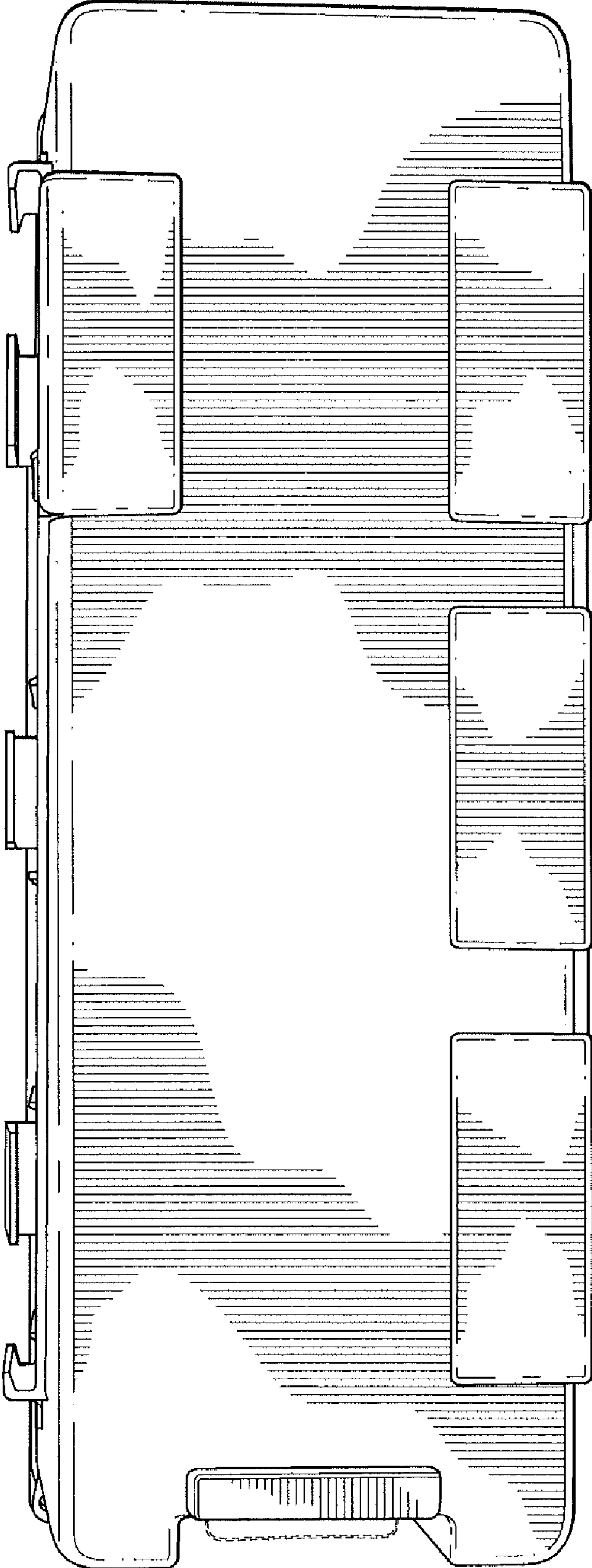

FIG. 21