

US00D670464S

(12) **United States Design Patent**
Mastio et al.

(10) **Patent No.:** **US D670,464 S**
(45) **Date of Patent:** **** Nov. 6, 2012**

(54) **POOL CLEANER**

(75) Inventors: **Emmanuel Mastio**, Fourquevaux (FR);
Philippe Blanc-Tailleur, Toulouse (FR);
Philippe Pichon, Villeneuve de Riviere (FR)

(73) Assignee: **Zodiac Pool Care Europe** (FR)

(**) Term: **14 Years**

(21) Appl. No.: **29/372,620**

(22) Filed: **Dec. 15, 2010**

(30) **Foreign Application Priority Data**

Jun. 30, 2010 (EM) 001222418-0001

(51) **LOC (9) Cl.** **15-05**

(52) **U.S. Cl.** **D32/21**

(58) **Field of Classification Search** D32/1,
D32/21, 31; 417/46; 210/167.16, 416.2;
134/168 R, 167 R, 169 R, 172, 21, 18; 15/1.7
See application file for complete search history.

(56) **References Cited**

U.S. PATENT DOCUMENTS

4,722,110	A	2/1988	Chandler	
D304,505	S *	11/1989	Maier et al.	D32/1
D325,452	S *	4/1992	Gefter	D32/21
5,245,723	A	9/1993	Sommer	
D400,319	S *	10/1998	Hofheins et al.	D32/1
D417,322	S *	11/1999	Hollinger	D32/1
D418,640	S *	1/2000	Veloskey et al.	D32/1
D430,960	S *	9/2000	van der Meyden et al.	D32/1
6,155,657	A	12/2000	Erlich et al.	
6,854,148	B1	2/2005	Rief et al.	
7,039,980	B2 *	5/2006	Van Der Meyden et al.	15/1.7
D599,967	S *	9/2009	Blanc-Tailleur	D32/1
7,805,792	B2	10/2010	Roumagnac	

D630,809 S * 1/2011 Dye et al. D32/21
2003/0201218 A1 10/2003 Henkin et al.
2004/0021439 A1 2/2004 Porat et al.

(Continued)

FOREIGN PATENT DOCUMENTS

EM 001222418-0001 6/2010

(Continued)

OTHER PUBLICATIONS

U.S. Appl. No. 29/372,613, filed Dec. 15, 2010.

(Continued)

Primary Examiner — Ruth McInroy

(74) *Attorney, Agent, or Firm* — Kilpatrick Townsend & Stockton LLP

(57) **CLAIM**

The ornamental design for a pool cleaner, as shown and described.

DESCRIPTION

FIG. 1 is a top, front, and right side perspective view of a pool cleaner, showing our new design.

FIG. 2 is a top, rear, and right side perspective view of the pool cleaner of FIG. 1.

FIG. 3 is a bottom, rear, and right side perspective view of the pool cleaner of FIG. 1.

FIG. 4 is a front elevation view of the pool cleaner of FIG. 1.

FIG. 5 is a right side elevation view of the pool cleaner of FIG. 1, the left side being a mirror image;

FIG. 6 is a rear elevation view of the pool cleaner of FIG. 1; and,

FIG. 7 is a top plan view of the pool cleaner of FIG. 1.

The details shown in broken lines in the drawings form no part of the claimed design.

1 Claim, 7 Drawing Sheets

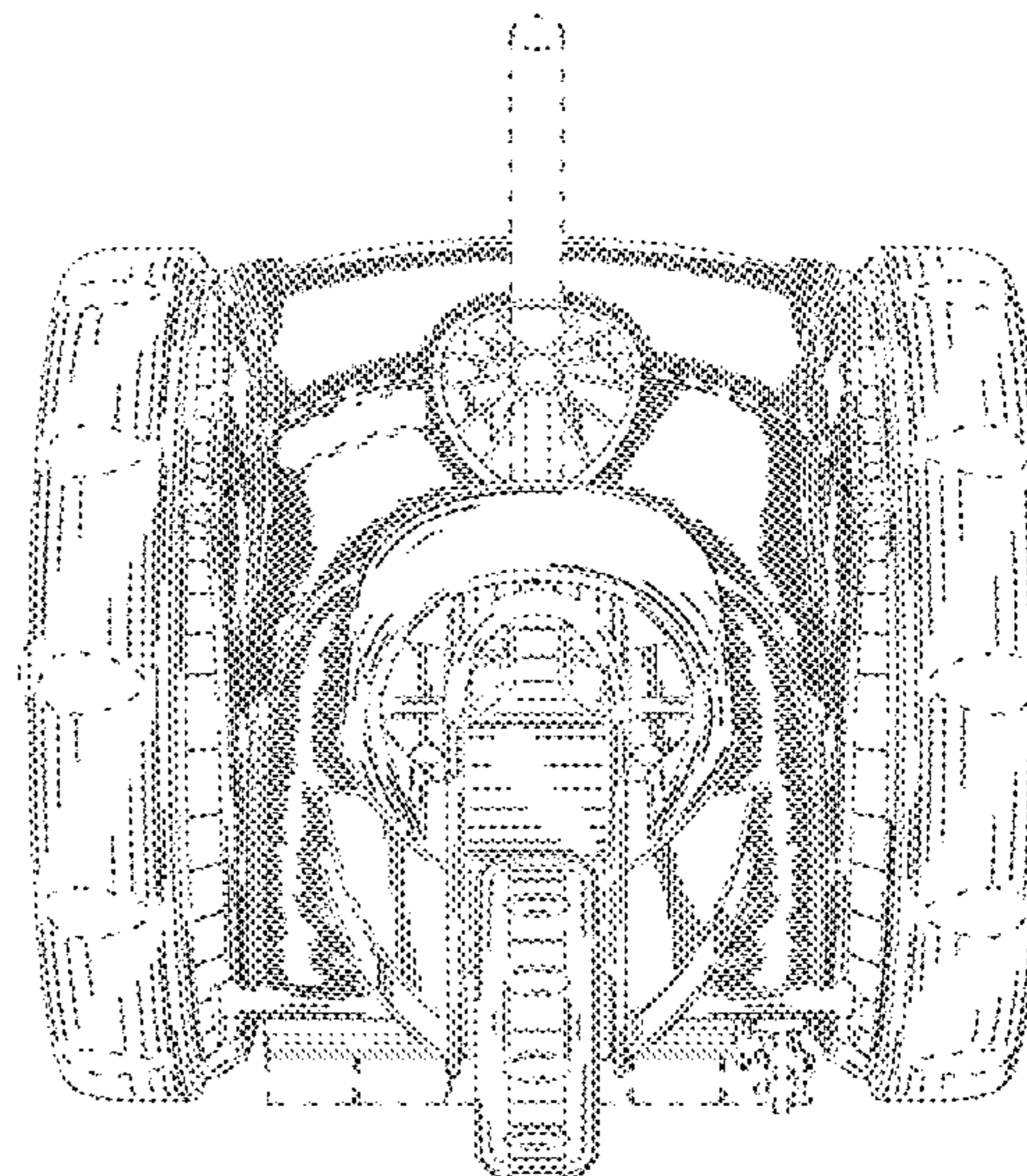
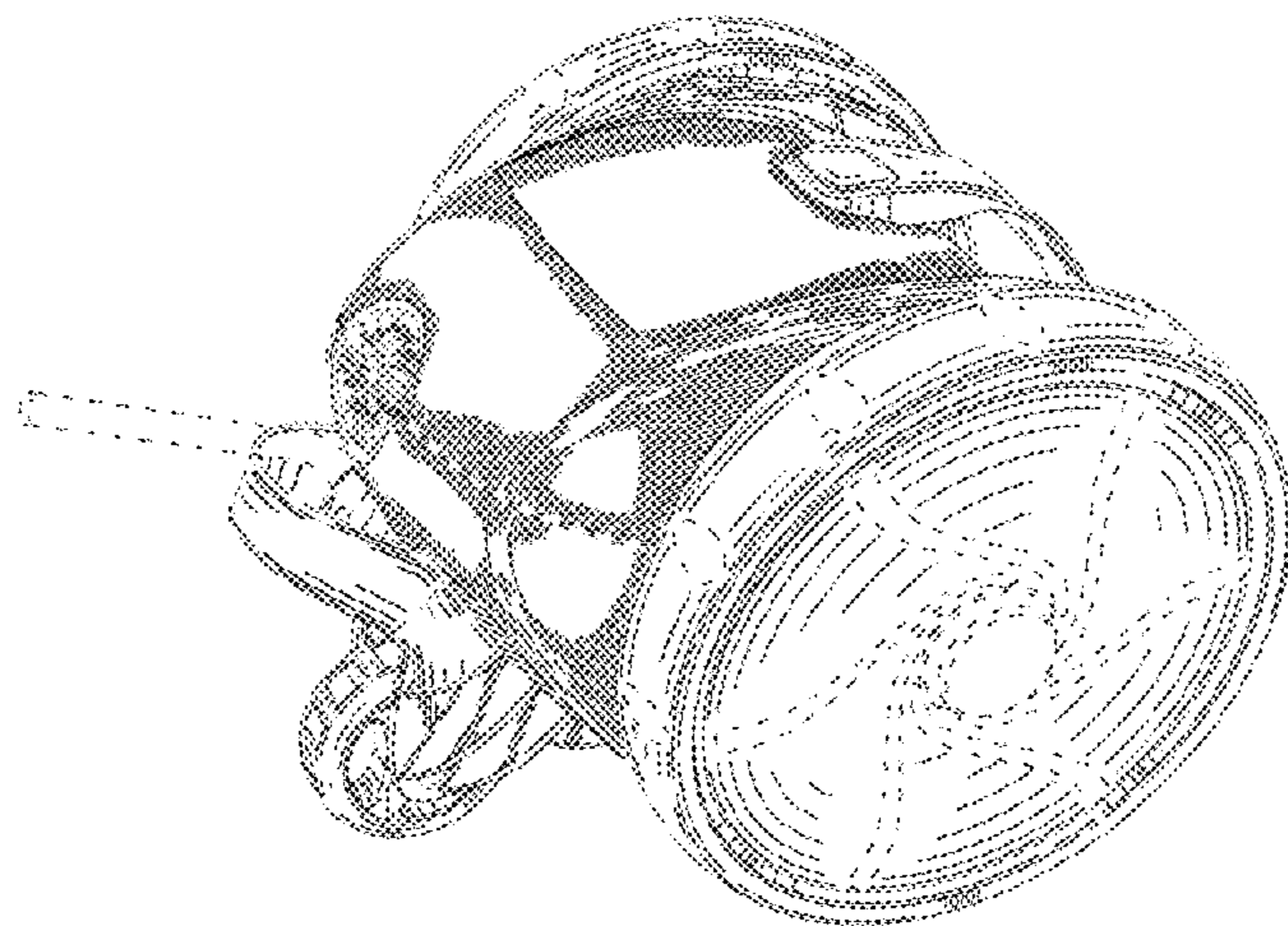

US D670,464 S

Page 2

U.S. PATENT DOCUMENTS

2004/0168838	A1	9/2004	Erlich et al.
2006/0102532	A1	5/2006	Cadotte
2007/0094817	A1	5/2007	Stoltz et al.
2008/0236628	A1	10/2008	Horvath et al.
2011/0000033	A1	1/2011	Pichon et al.
2011/0016646	A1	1/2011	Pichon et al.
2011/0020139	A1	1/2011	Pichon et al.
2011/0154585	A1*	6/2011	Mastio et al. 15/1.7

FR	0906139	12/2009
FR	0906140	12/2009
FR	0906141	12/2009
FR	0906230	12/2009
WO	WO 8700883	2/1987
WO	WO 0250388	6/2002
WO	WO 02092189	11/2002
WO	WO 2009081044	7/2009

OTHER PUBLICATIONS

FOREIGN PATENT DOCUMENTS

EP	1022411	7/2000
EP	1070850	1/2001
EP	1302611	4/2003
FR	2567552	1/1986
FR	2583997	1/1987
FR	2584442	1/1987
FR	2896005	7/2007
FR	2925552	6/2009
FR	2925553	6/2009
FR	2925558	6/2009
FR	2929311	10/2009
FR	0906137	12/2009
FR	0906138	12/2009

U.S. Appl. No. 29/372,614, filed Dec. 15, 2010.
U.S. Appl. No. 29/372,615, filed Dec. 15, 2010.
U.S. Appl. No. 29/372,616, filed Dec. 15, 2010.
U.S. Appl. No. 29/372,617, filed Dec. 15, 2010.
U.S. Appl. No. 29/372,621, filed Dec. 15, 2010.
U.S. Appl. No. 29/372,624, filed Dec. 15, 2010.
U.S. Appl. No. 61/300,540, filed Feb. 2, 2010.
U.S. Appl. No. 61/300,534, filed Feb. 2, 2010.
U.S. Appl. No. 61/300,520, filed Feb. 2, 2010.
U.S. Appl. No. 61/302,191, filed Feb. 8, 2010.
U.S. Appl. No. 61/300,545, filed Feb. 2, 2010.

* cited by examiner

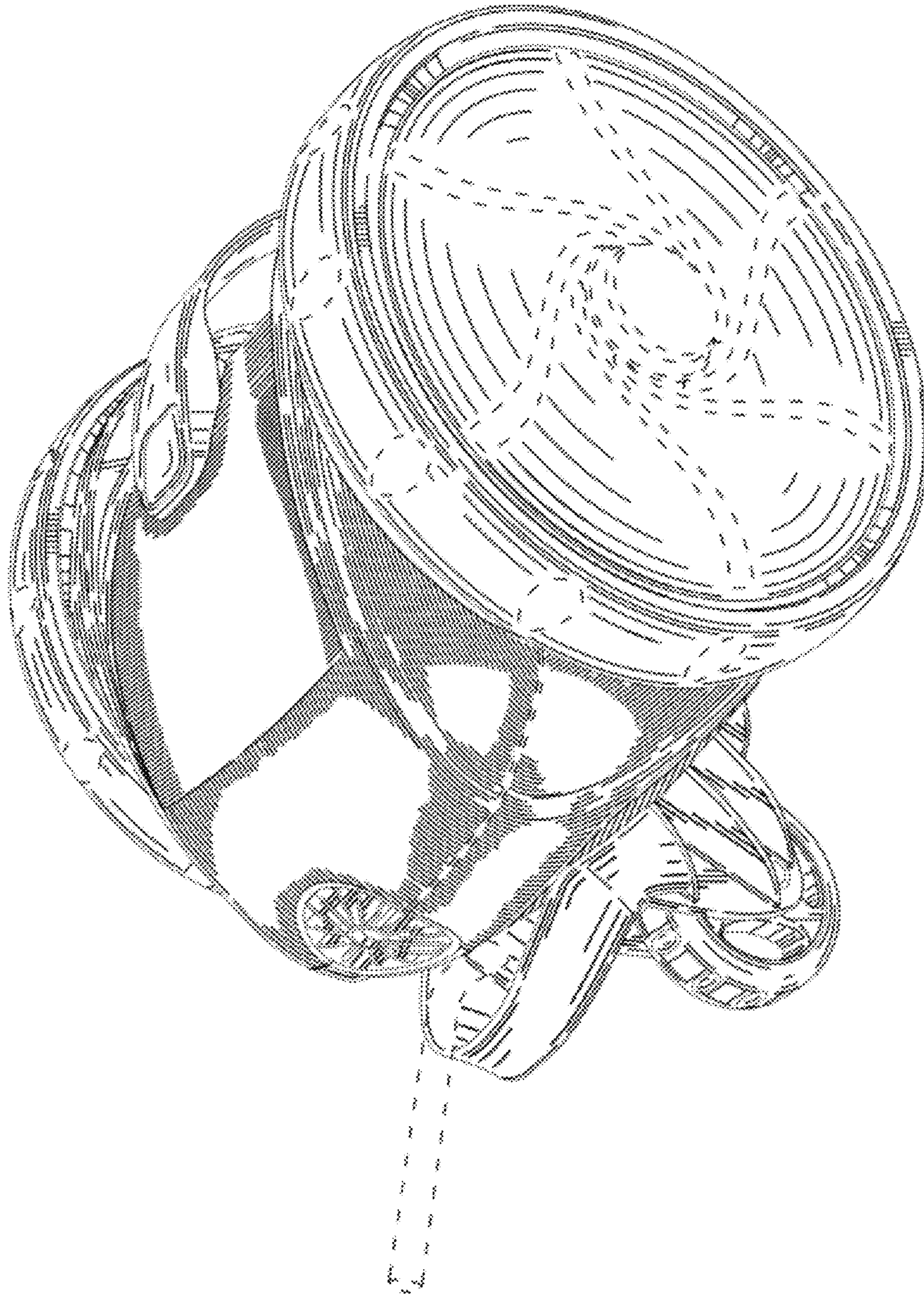

FIG. 1

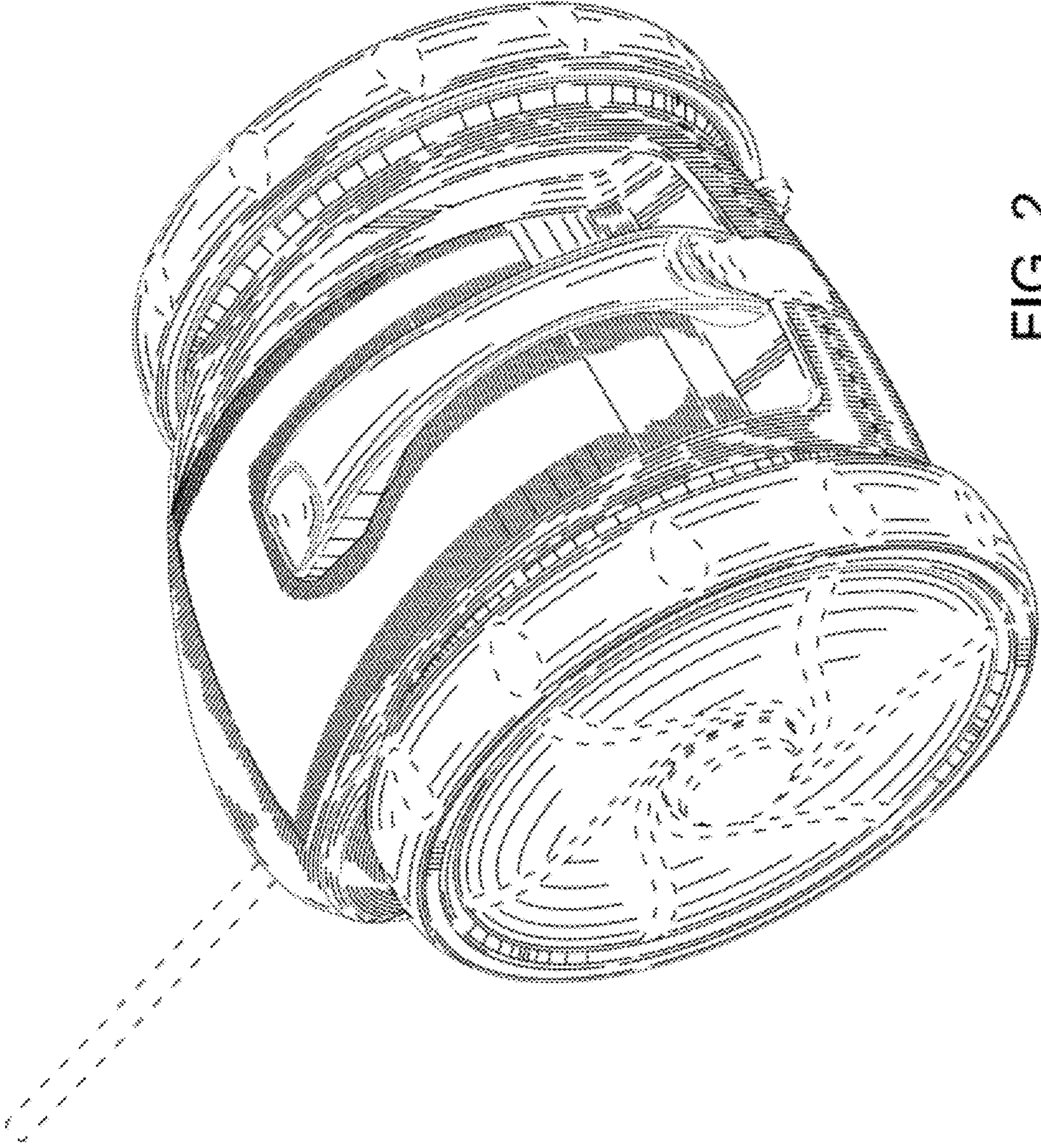

FIG. 2

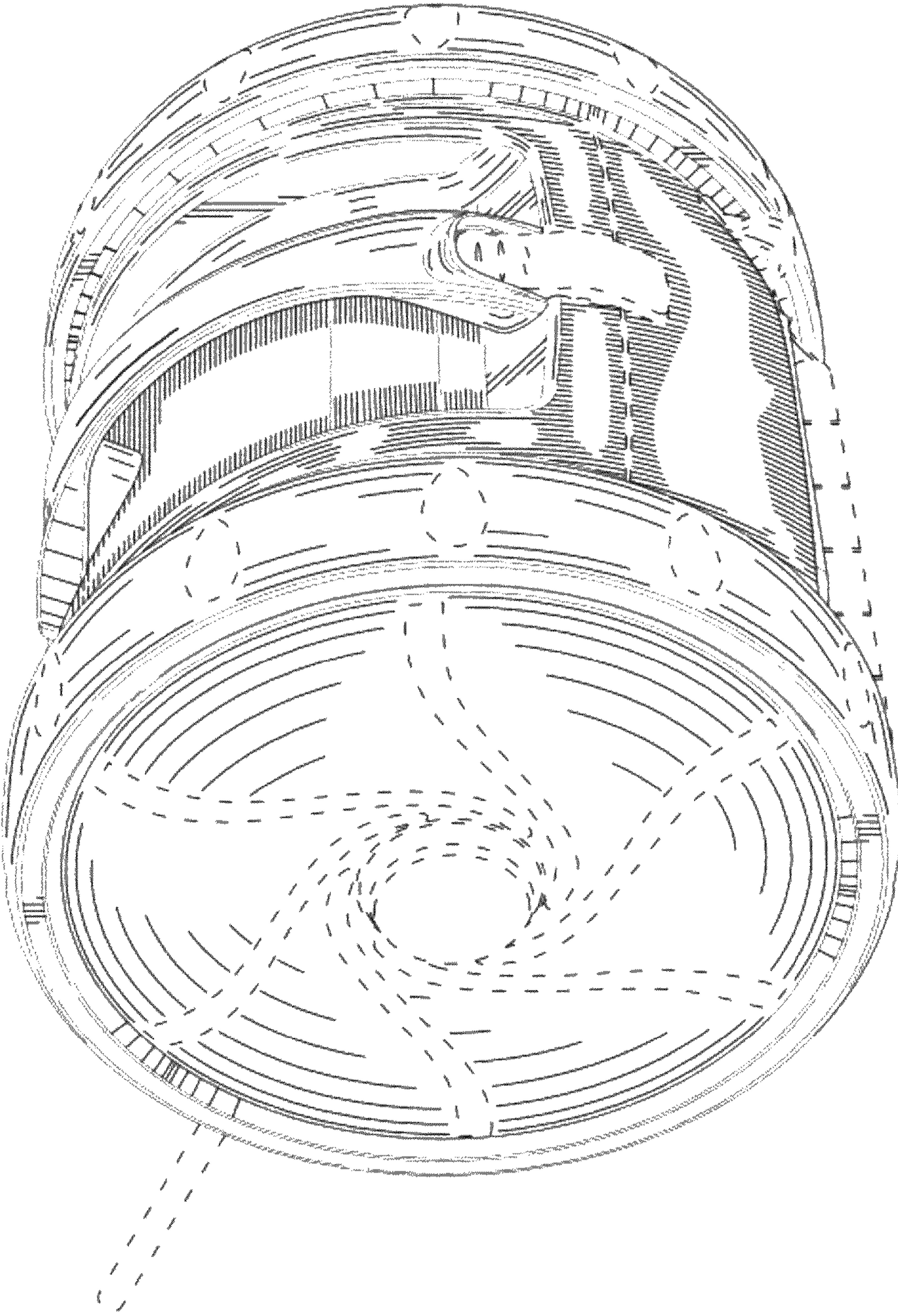

FIG. 3

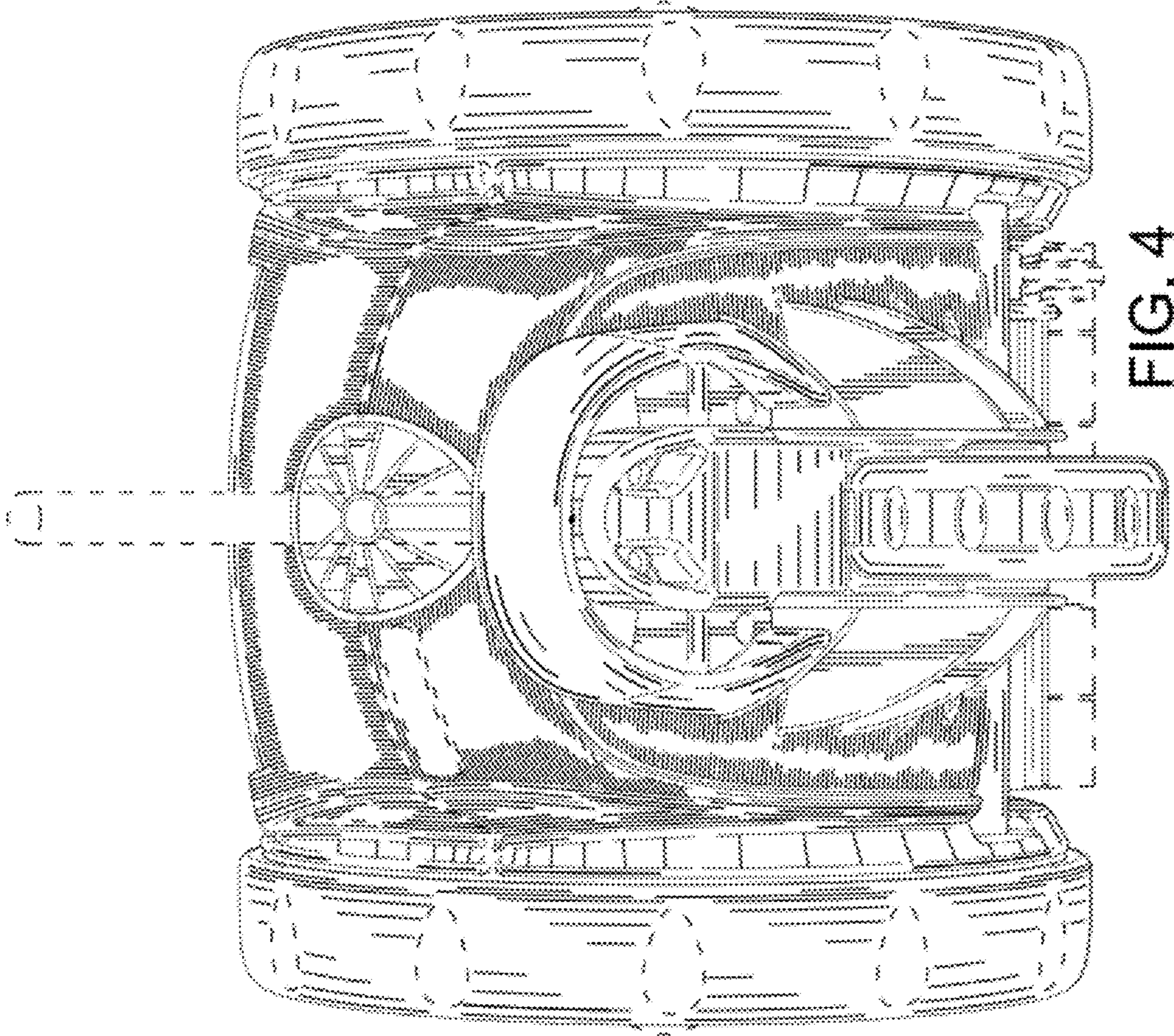

FIG. 4

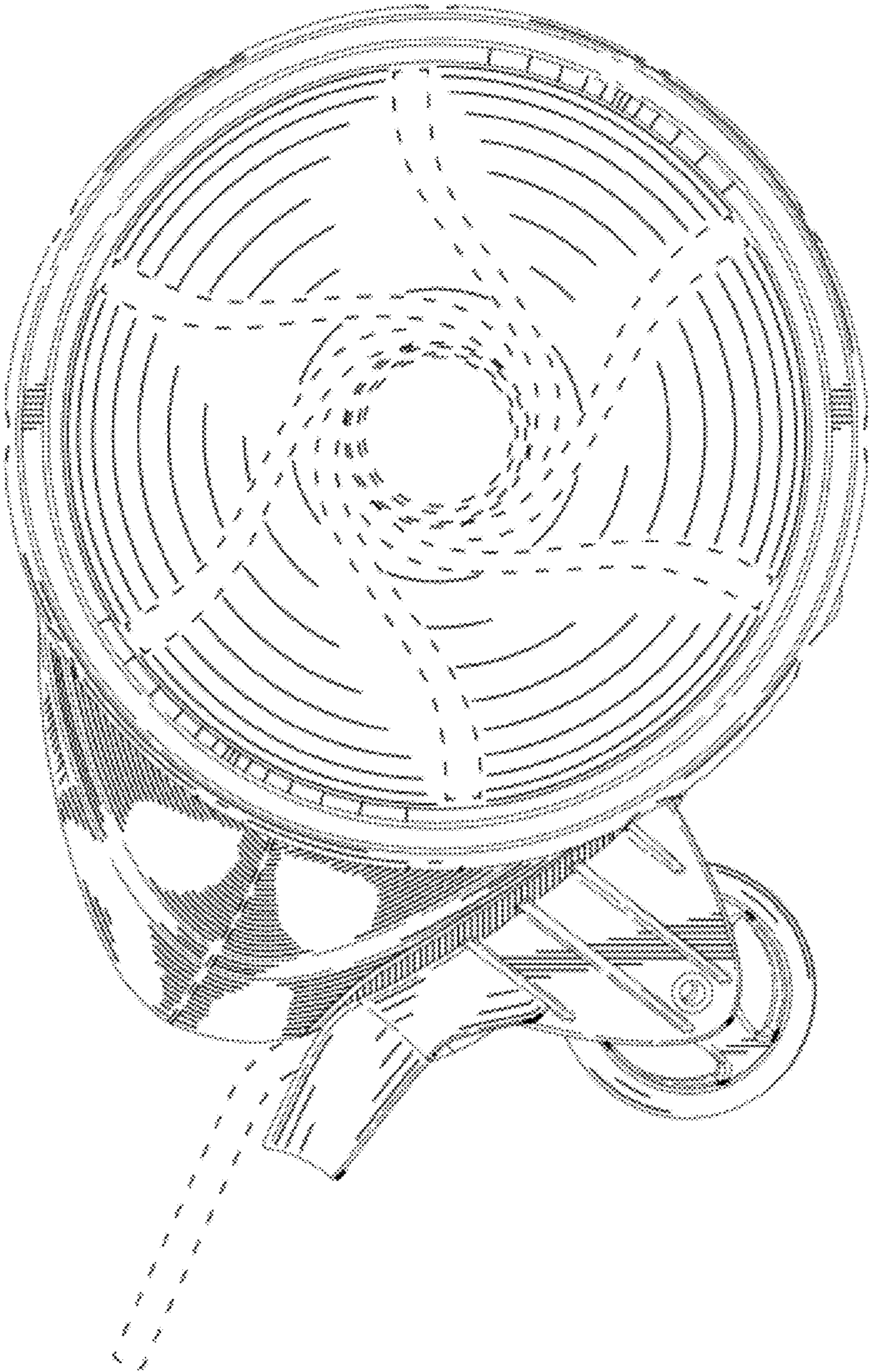

FIG. 5

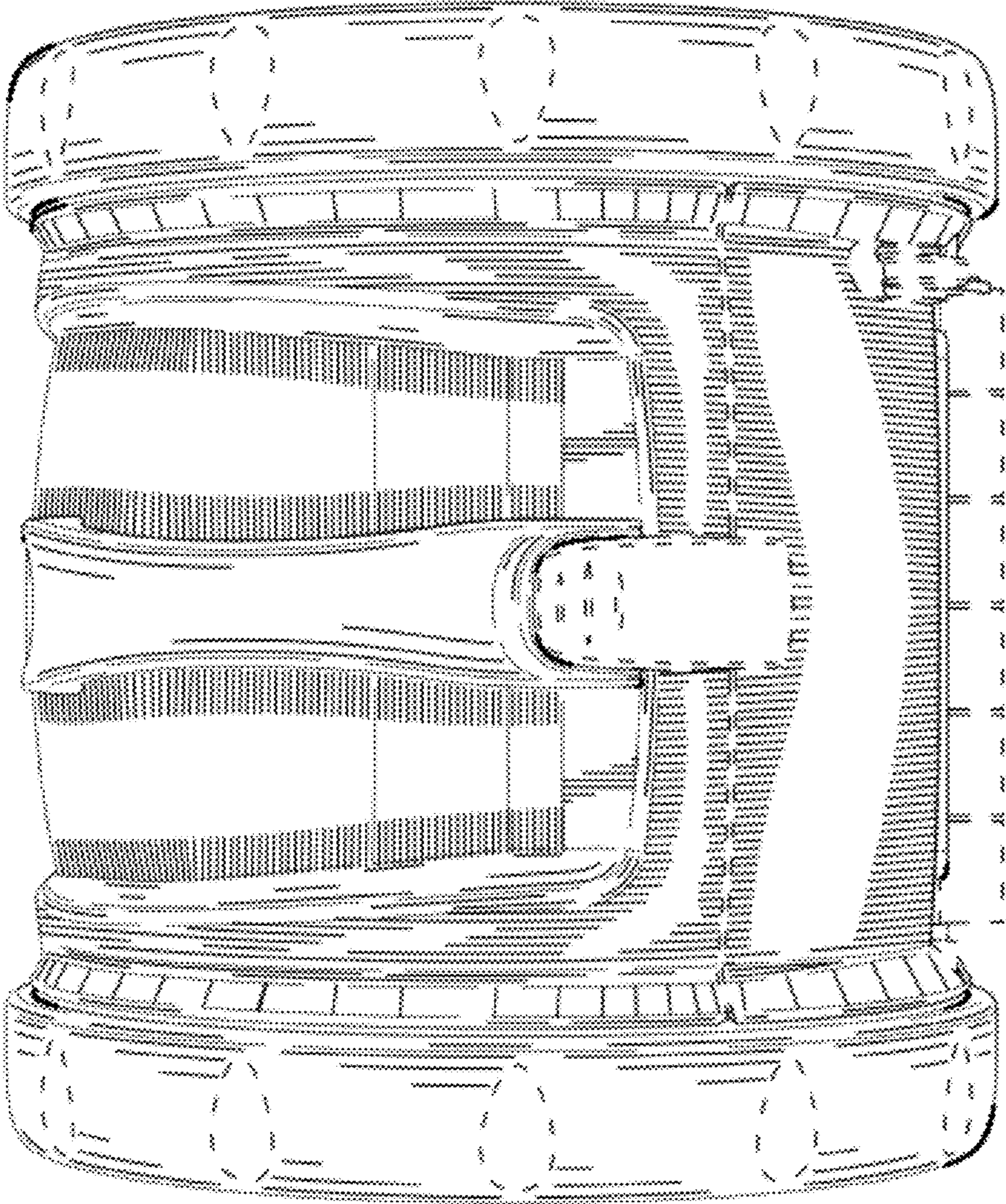

FIG. 6

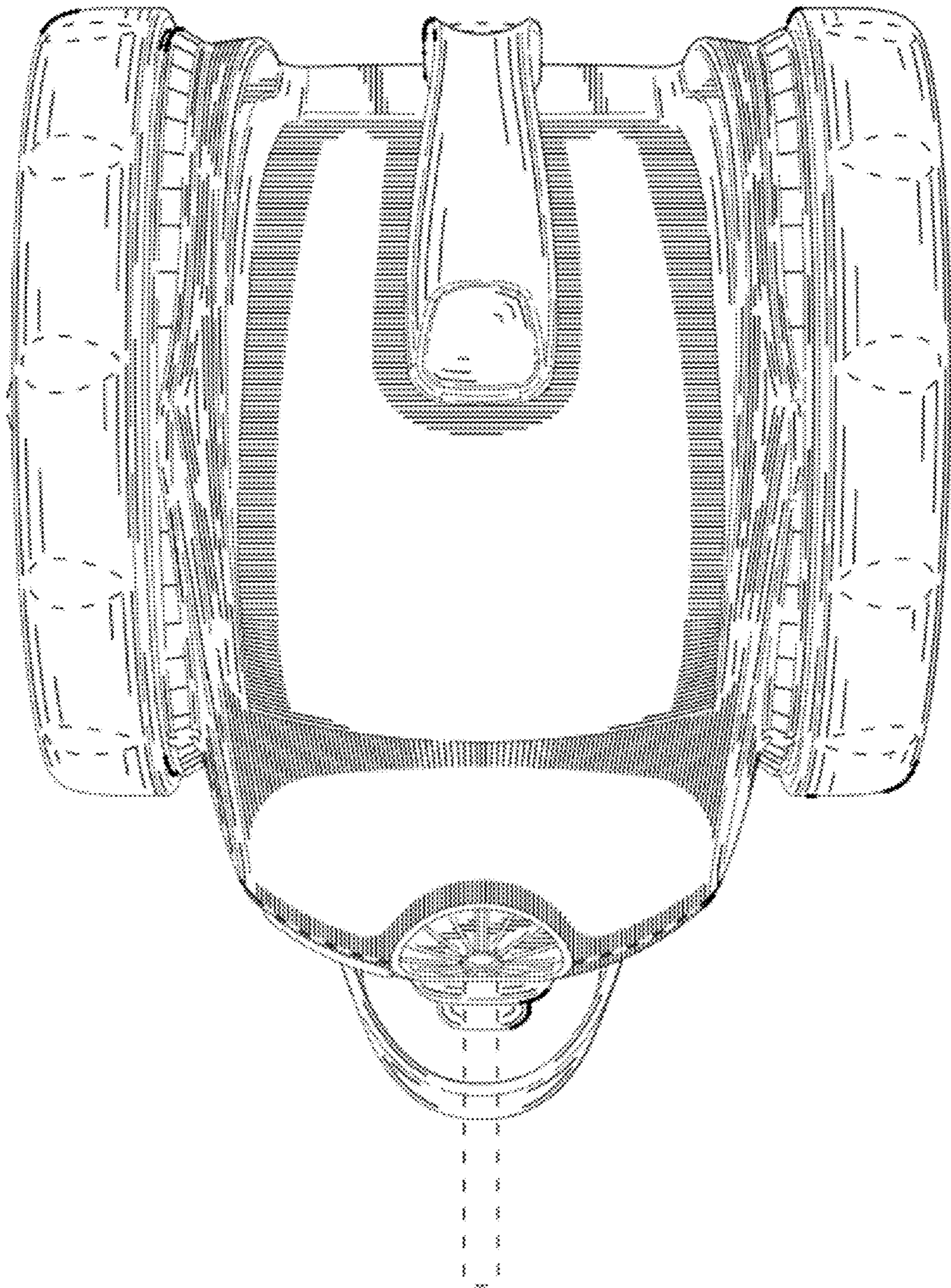

FIG. 7