

US00D670458S

(12) **United States Design Patent**
Seo et al.

(10) **Patent No.:** **US D670,458 S**
(45) **Date of Patent:** **** Nov. 6, 2012**

(54) **COMBINED VACUUM CLEANER AND CHARGER**

(75) Inventors: **Woon Kyu Seo**, Seoul (KR); **Dae Sung Lee**, Gyeonggi-do (KR); **Young Soo Ha**, Seoul (KR); **Sun Il Cho**, Gyeonggi-do (KR)

(73) Assignee: **LG Electronics Inc.**, Seoul (KR)

(**) Term: **14 Years**

(21) Appl. No.: **29/386,567**

(22) Filed: **Mar. 2, 2011**

(30) **Foreign Application Priority Data**

Sep. 3, 2010 (KR) 30-2010-0038863

(51) **LOC (9) Cl.** **15-05**

(52) **U.S. Cl.** **D32/18**

(58) **Field of Classification Search** D32/17-18,
D32/22, 31; 15/320-321, 350-354, 415.1-422,
15/329, 344, 361, 410-411, 347, 1.7, DIG. 1;
55/DIG. 3; D13/108

See application file for complete search history.

(56) **References Cited**

U.S. PATENT DOCUMENTS

D207,632 S *	5/1967	Anderson	D32/17
D223,856 S *	6/1972	Grube	D32/17
4,670,701 A *	6/1987	Sako et al.	320/115
D294,412 S *	2/1988	Sadashima et al.	D32/18
D303,170 S *	8/1989	Hirano	D32/18
D306,657 S *	3/1990	Fushiya et al.	D32/18

D352,141 S *	11/1994	Correa et al.	D32/18
D371,649 S *	7/1996	Neshat et al.	D32/18
D507,852 S *	7/2005	Cheng	D32/18
D543,324 S *	5/2007	Yoon	D32/22
D564,148 S *	3/2008	Fjellman	D32/18
D564,150 S *	3/2008	Fjellman	D32/18
D569,563 S *	5/2008	Shin et al.	D32/18
D589,218 S *	3/2009	Shin	D32/18
D594,607 S *	6/2009	Farone et al.	D32/18
D608,513 S *	1/2010	Ho	D32/22
D611,209 S *	3/2010	Shin	D32/18
D628,961 S *	12/2010	Kim et al.	D13/108
D640,848 S *	6/2011	Houghton	D32/18
D645,403 S *	9/2011	Seo et al.	D13/108
D653,008 S *	1/2012	Houghton	D32/18

* cited by examiner

Primary Examiner — Ruth McInroy

(74) *Attorney, Agent, or Firm* — Birch, Stewart, Kolasch & Birch, LLP

(57) **CLAIM**

We claim the ornamental design for a combined vacuum cleaner and charger, as shown and described.

DESCRIPTION

FIG. 1 is a perspective view of a combined vacuum cleaner and charger showing our new design;
FIG. 2 is a front elevation view thereof;
FIG. 3 is a rear elevation view thereof;
FIG. 4 is a left-side elevation view thereof;
FIG. 5 is a right-side elevation view thereof;
FIG. 6 is a top plan view thereof; and,
FIG. 7 is a bottom plan view thereof.

1 Claim, 7 Drawing Sheets

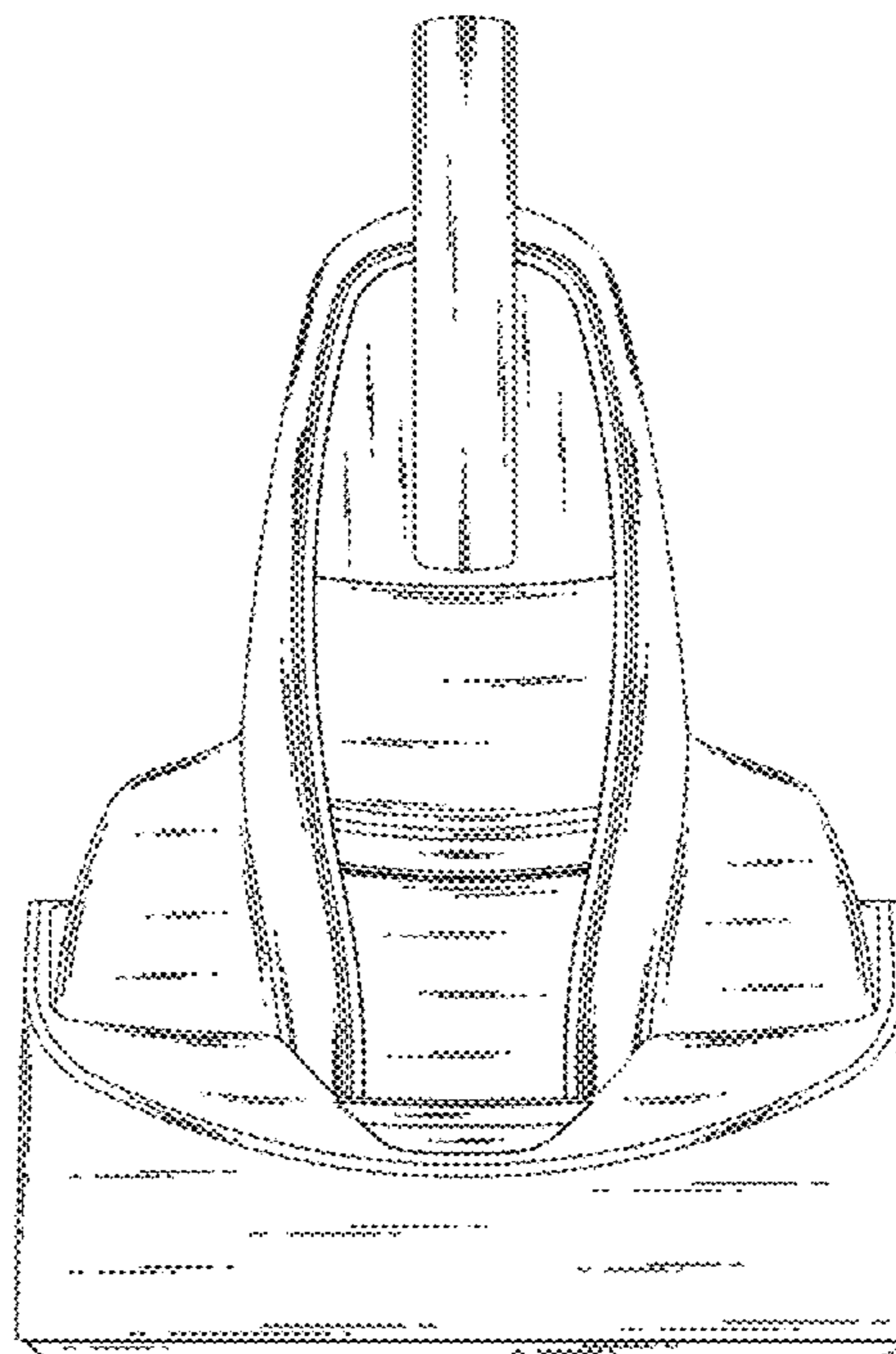
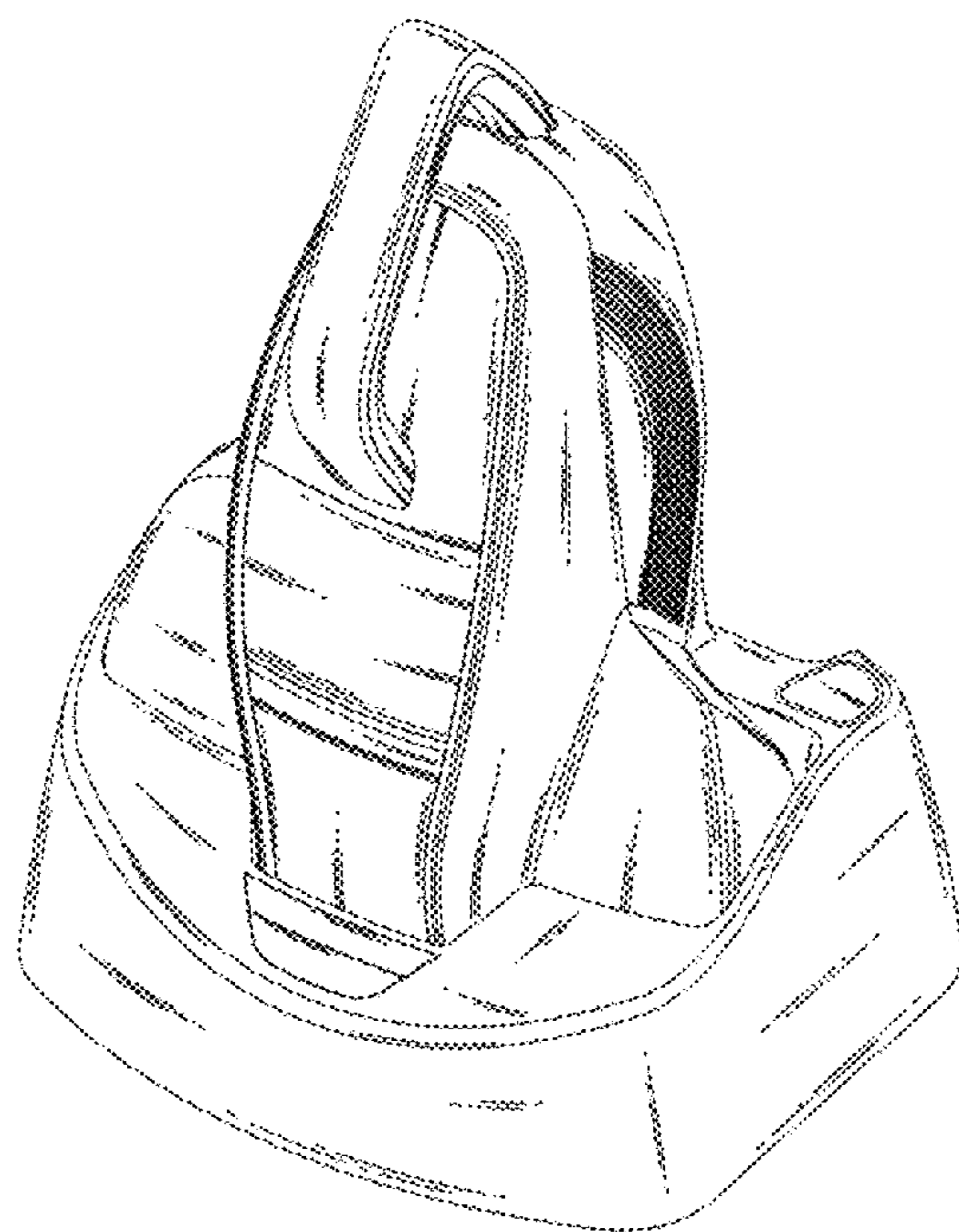

FIG. 1

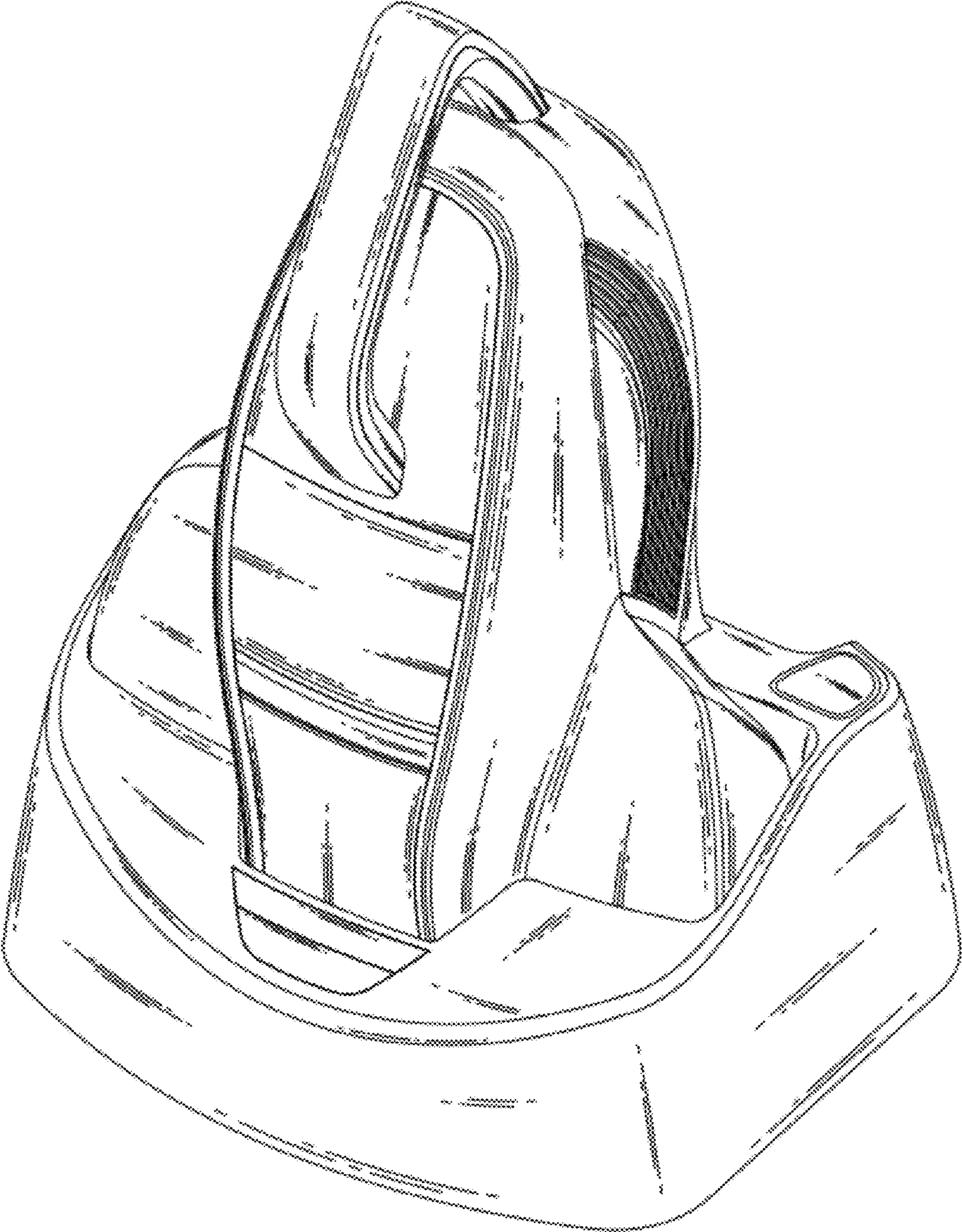

FIG.2

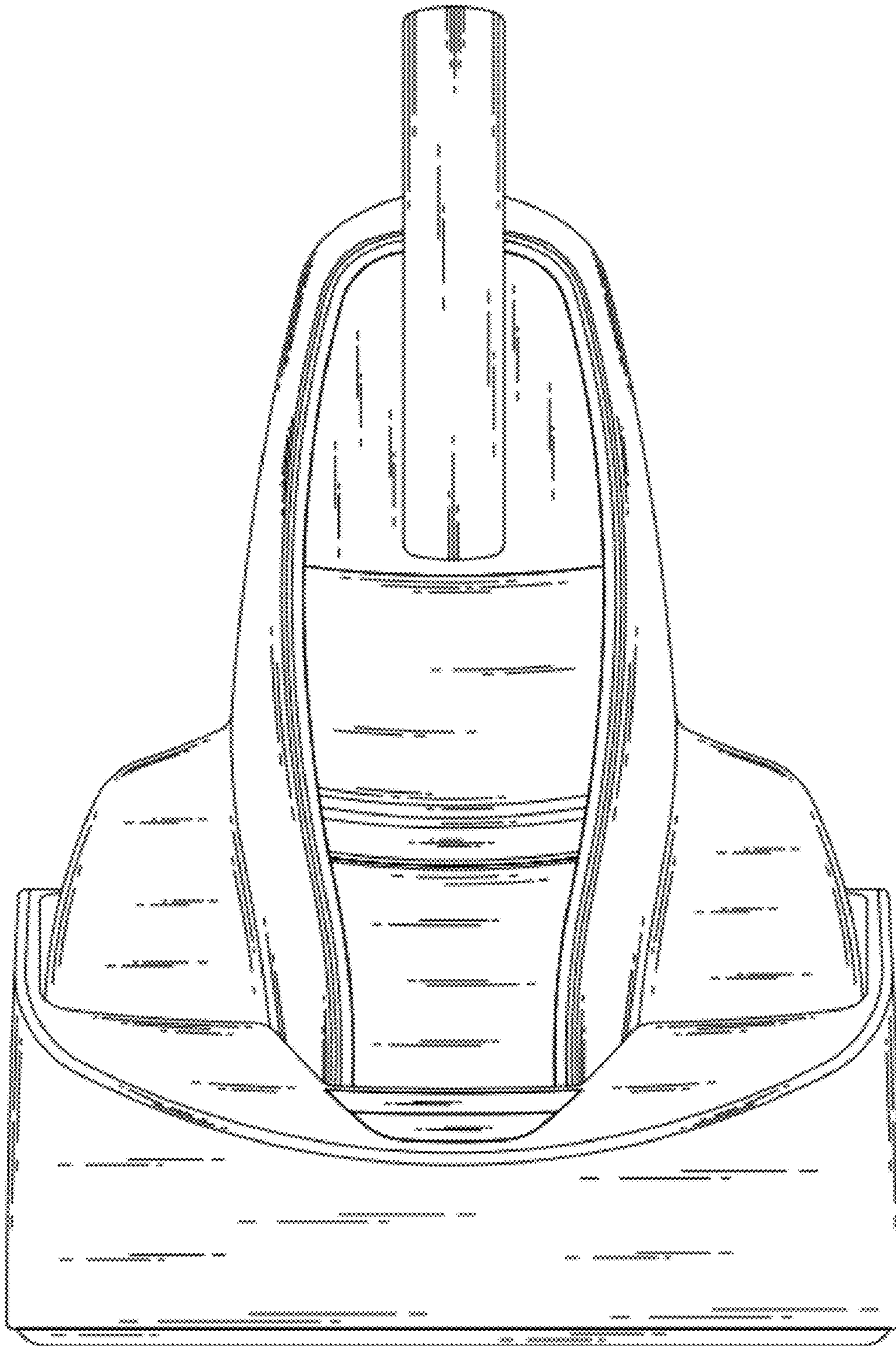

FIG.3

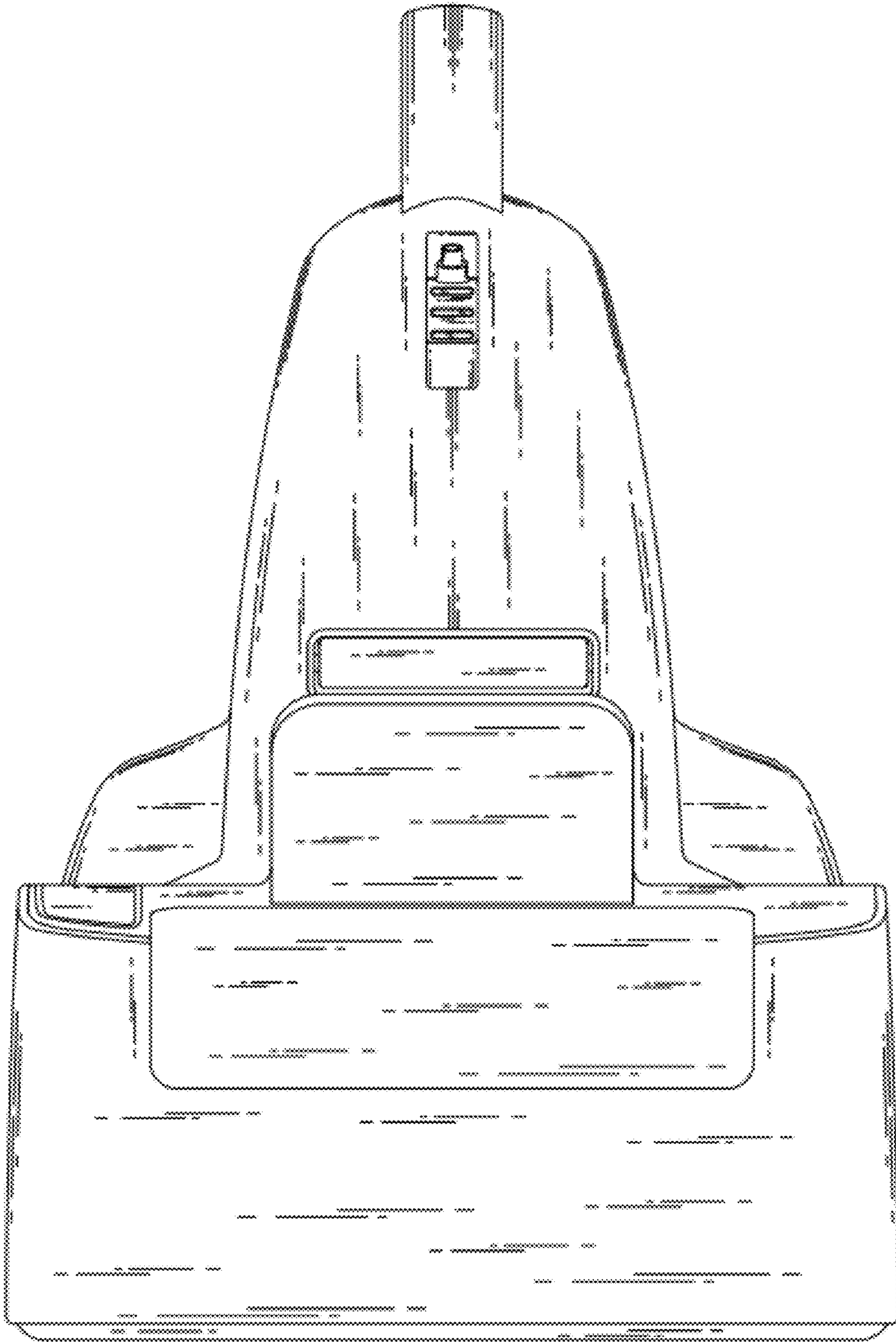

FIG.4

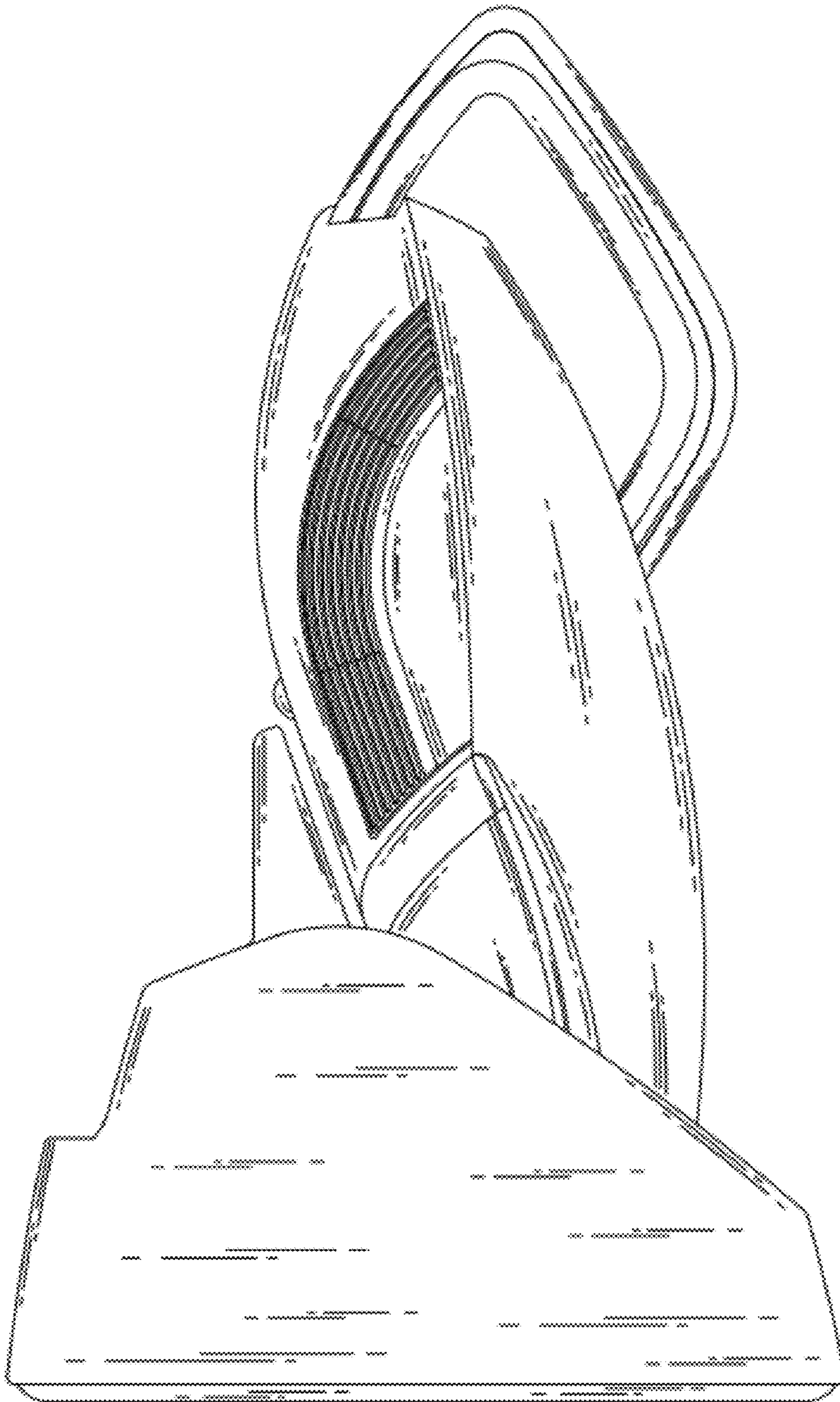

FIG. 5

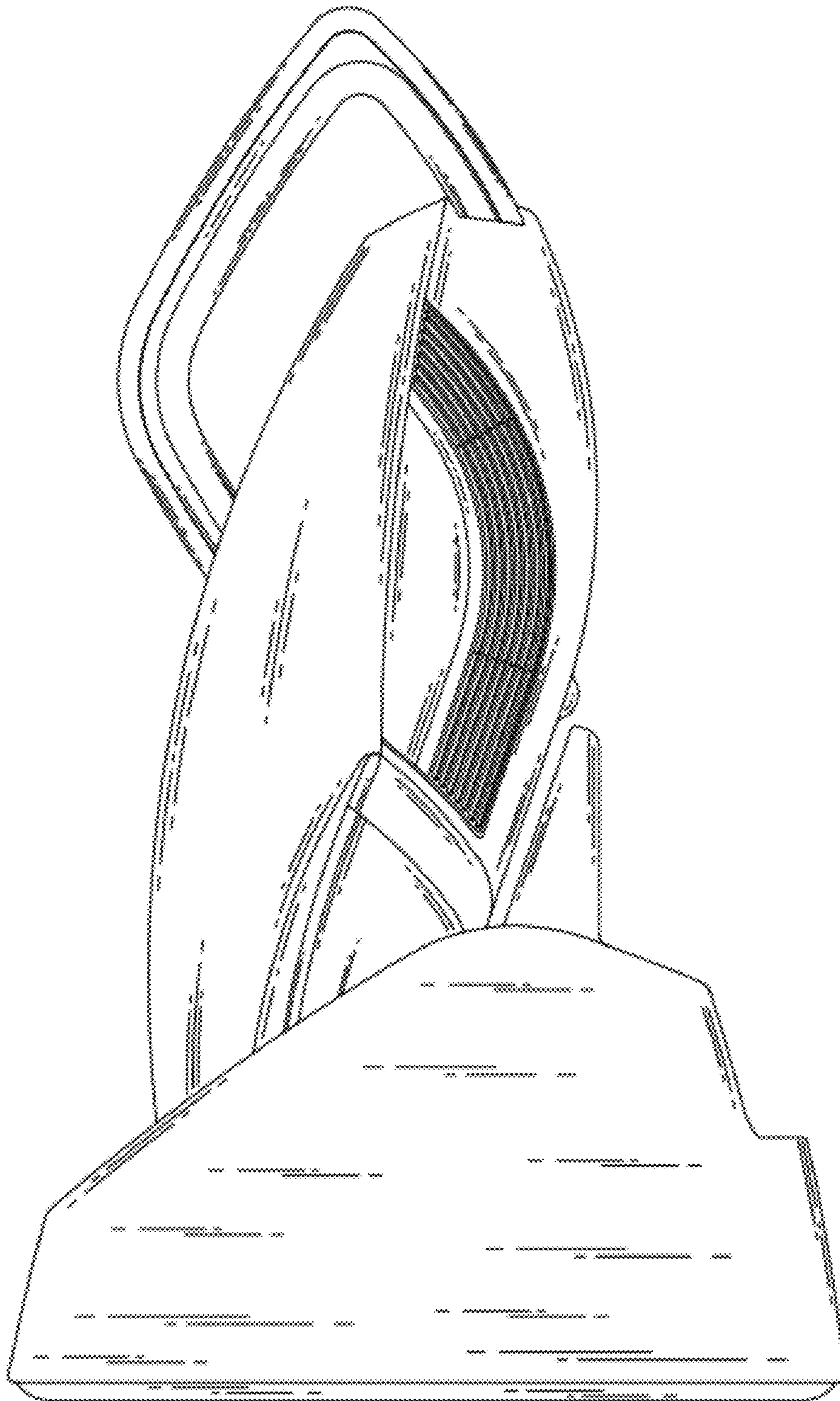

FIG.6

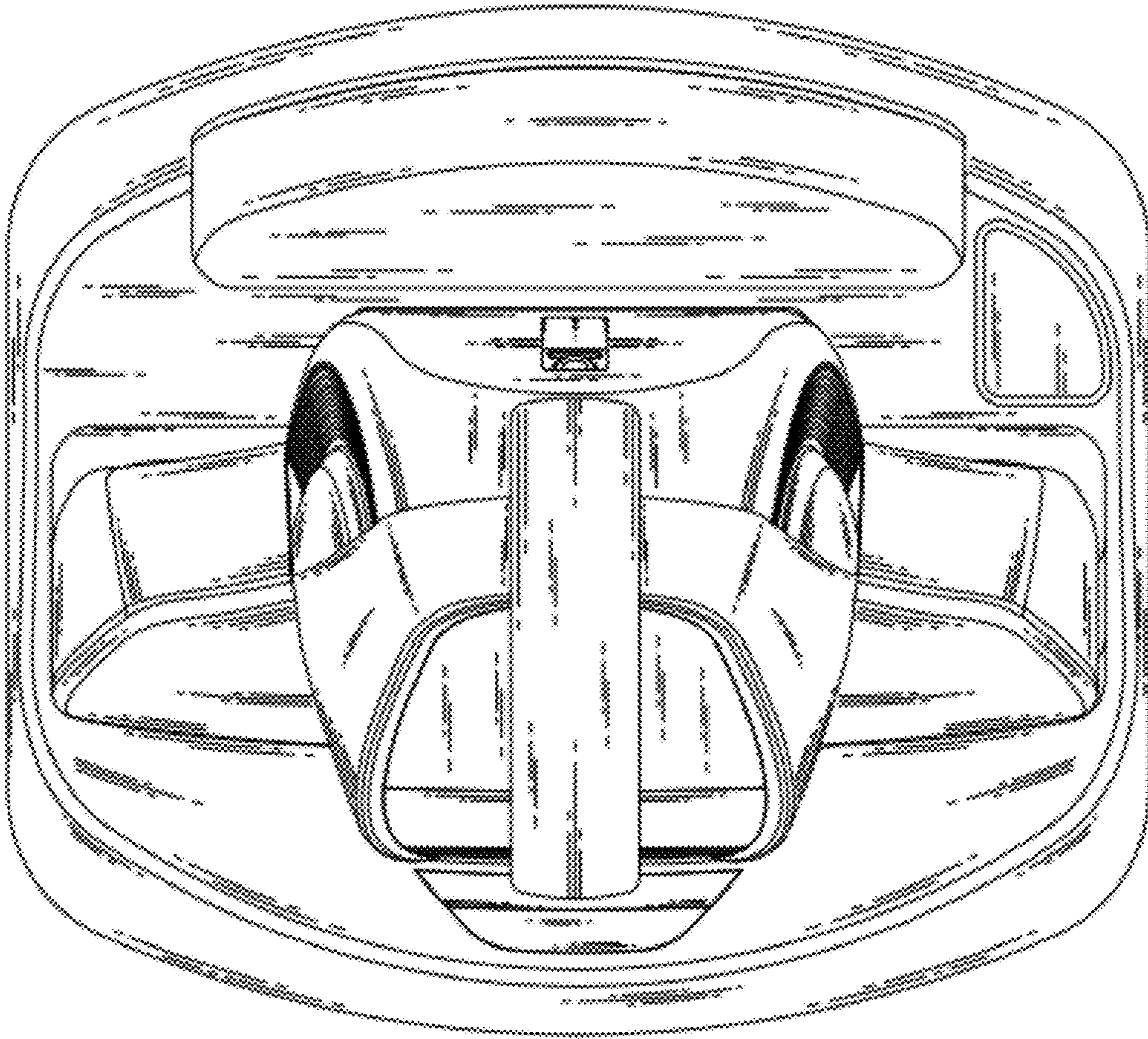

FIG. 7

