



US00D670435S

(12) **United States Design Patent**
Blackford

(10) **Patent No.:** **US D670,435 S**
(45) **Date of Patent:** **** Nov. 6, 2012**

(54) **HEAT REFLECTIVE MATERIAL WITH PATTERN**

(75) Inventor: **Michael E. "Woody" Blackford,**
Portland, OR (US)

(73) Assignee: **Columbia Sportswear North America, Inc.,**
Portland, OR (US)

(**) Term: **14 Years**

(21) Appl. No.: **29/360,364**

(22) Filed: **Apr. 23, 2010**

Related U.S. Application Data

(63) Continuation-in-part of application No. 29/336,730,
filed on May 7, 2009, now Pat. No. Des. 650,529.

(51) **LOC (9) Cl.** **29-02**

(52) **U.S. Cl.** **D29/101.1**

(58) **Field of Classification Search** D29/100,
D29/101.1, 101.2, 101.3, 101.4, 101.5, 124,
D29/125, 126, 129, 130; D5/57, 60, 61,
D5/99; 2/81, 82, 458; 428/131
See application file for complete search history.

(56) **References Cited**

U.S. PATENT DOCUMENTS

D92,994 S	5/1934	Aaronson	
D107,621 S	12/1937	Stiglitz	
D118,109 S	12/1939	Callahan	
D119,351 S	5/1940	Katz	
D129,870 S	10/1941	Maisch	
D130,877 S	12/1941	Tips	
2,471,008 A	4/1946	Pretty	
D154,151 S	6/1949	Ryan	
D158,550 S	5/1950	Breneman	
D169,305 S *	4/1953	De Grazia D29/101.4
3,418,668 A	12/1968	Anderson	
3,577,305 A	5/1971	Hines et al.	
3,663,182 A	5/1972	Hamling	
3,800,364 A	4/1974	Kalwaites	
3,849,802 A	11/1974	Govaars	
3,917,785 A	11/1975	Kalwaites	
3,924,929 A	12/1975	Holmen et al.	
3,934,065 A	1/1976	Tung	

4,032,681 A	6/1977	Jonnes	
4,211,261 A	7/1980	Mehta et al.	
4,395,455 A	7/1983	Frankosky	
4,420,521 A	12/1983	Carr	
4,435,442 A	3/1984	Hefele	
4,463,464 A	8/1984	Bost et al.	
4,483,021 A	11/1984	McCall	
4,525,406 A	6/1985	Pollock	
4,569,088 A	2/1986	Frankenburg et al.	
4,569,874 A	2/1986	Kuznetz	
4,622,253 A	11/1986	Levy	
4,637,947 A	1/1987	Maekawa et al.	
4,712,609 A	12/1987	Iversen	
4,765,323 A	8/1988	Poettgen	
4,798,754 A	1/1989	Tomek	
4,856,294 A	8/1989	Scaringe et al.	
5,098,795 A	3/1992	Webb et al.	
5,366,785 A	11/1994	Sawdai	
D358,734 S	5/1995	Paskwietz et al.	
5,415,222 A	5/1995	Colvin	
5,520,778 A	5/1996	Sawdai	
D404,236 S	1/1999	Bergwall et al.	
D413,731 S	9/1999	Hannington	
D414,252 S	9/1999	Orr	
D414,642 S	10/1999	Williams	
D428,293 S	7/2000	Williams	
6,191,056 B1	2/2001	Vogt et al.	
6,242,369 B1	6/2001	Vogt et al.	
6,319,599 B1	11/2001	Buckley	
6,321,386 B1	11/2001	Monica	
6,341,384 B1	1/2002	Hayes	
6,427,242 B1	8/2002	Bush et al.	
6,511,929 B1	1/2003	Vogt et al.	
D472,419 S	4/2003	Robbins, III	
D477,743 S	7/2003	de Pauw	
6,589,631 B1	7/2003	Suzuki et al.	
6,591,560 B2	7/2003	Burke, III et al.	
D478,494 S	8/2003	Arnold	
D478,761 S	8/2003	Robbins, III	
6,687,913 B2 *	2/2004	Aldridge 2/81
6,743,498 B2 *	6/2004	Fourmeux 428/131
D497,072 S	10/2004	Suero, Jr.	
6,811,852 B2	11/2004	Alderman	
6,824,819 B2	11/2004	Vogt et al.	
6,855,410 B2	2/2005	Buckley	
6,858,068 B2	2/2005	Smith et al.	
6,874,336 B2	4/2005	Yarborough et al.	
D508,180 S	8/2005	Sneed	
6,934,985 B2	8/2005	Sanders	
6,978,481 B2 *	12/2005	Mordecai et al. 2/81
D518,248 S	3/2006	Northrop	
7,013,496 B2 *	3/2006	Dunn 2/458
7,226,879 B2	6/2007	Tilton et al.	

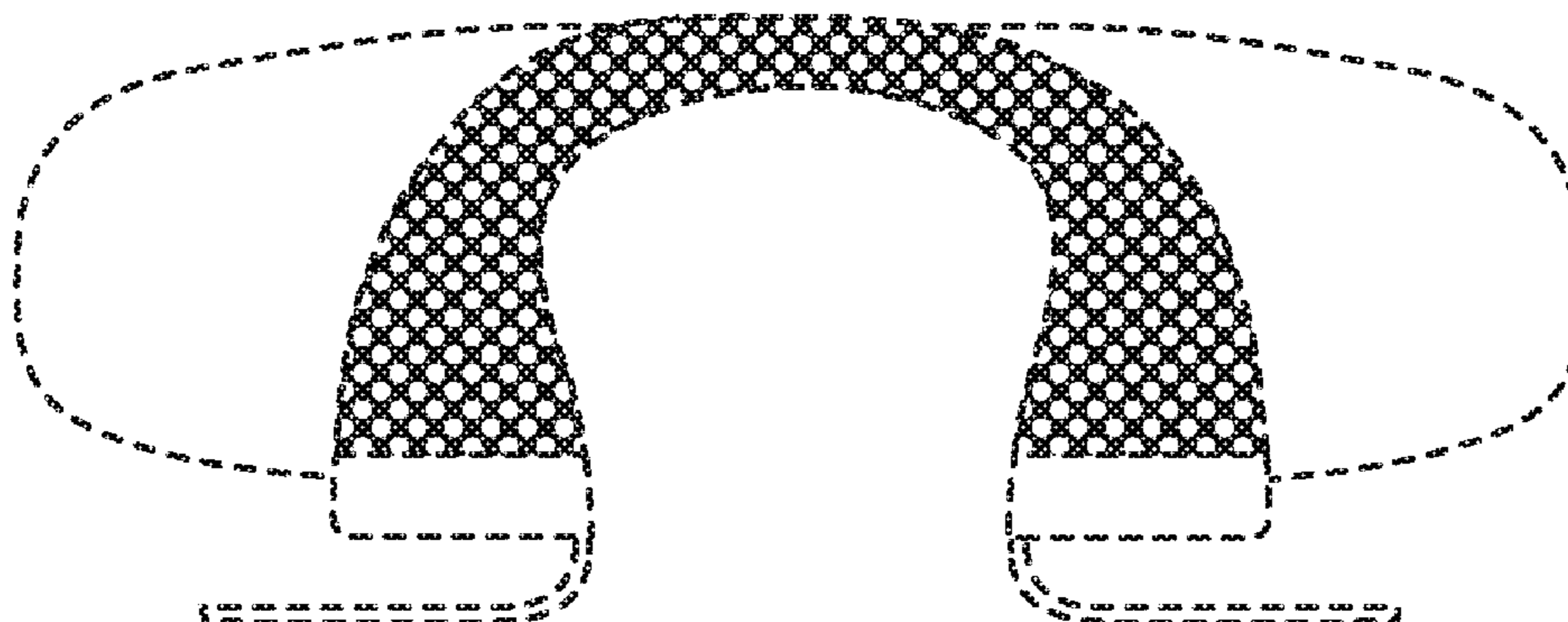

D548,400	S	8/2007	Boord	
D551,407	S	9/2007	Caruso et al.	
7,399,919	B2	7/2008	McCutcheon et al.	
D583,569	S	12/2008	Claudat	
D583,999	S *	12/2008	Middlebrooks	D29/101.4
7,465,484	B2	12/2008	Handwerker	
D590,949	S	4/2009	Broyles	
D596,860	S	7/2009	Doughty	
D598,166	S *	8/2009	Kemper	D29/101.4
7,581,260	B2 *	9/2009	Underwood et al.	2/82
D613,948	S	4/2010	Spritzer	
D628,005	S	11/2010	Chapman et al.	
7,854,017	B2 *	12/2010	Laton	2/81
D630,442	S	1/2011	Sichel	
D631,262	S	1/2011	Evans	
D631,670	S *	2/2011	Jackson	D5/99
D637,008	S	5/2011	Frost	
D638,224	S	5/2011	Ko et al.	
2003/0027476	A1	2/2003	Vogt et al.	
2004/0128747	A1	7/2004	Bumbarger et al.	
2004/0261465	A1	12/2004	Yarborough et al.	
2005/0077618	A1	4/2005	McCutcheon et al.	
2005/0209663	A1	9/2005	Hamilton et al.	
2005/0251900	A1	11/2005	Harlacker	
2005/0252036	A1	11/2005	Laska	
2007/0037034	A1	2/2007	Fisher et al.	
2007/0129767	A1	6/2007	Wahlstrand	
2007/0267583	A1	11/2007	Dodo	
2007/0267595	A1	11/2007	Dodo	
2007/0277806	A1	12/2007	Dodo	
2008/0099188	A1	5/2008	Touzov	
2008/0251062	A1	10/2008	Dodo	
2008/0257333	A1	10/2008	Dodo et al.	
2008/0282455	A1	11/2008	Jones et al.	
2008/0283038	A1	11/2008	Dodo	
2009/0000610	A1	1/2009	Dodo	
2009/0209155	A1	8/2009	Goulet	
2009/0258180	A1	10/2009	Goulet	
2010/0020056	A1	1/2010	Le Roy et al.	
2010/0071119	A1	3/2010	Thatcher	
2010/0107657	A1	5/2010	Vistakula	
2010/0138983	A1	6/2010	Kim	
2010/0282433	A1	11/2010	Blackford	
2010/0326710	A1	12/2010	Zhang	
2011/0036282	A1	2/2011	Cote	
2011/0107771	A1	5/2011	Crist et al.	
2011/0135899	A1	6/2011	Meltzer et al.	
2011/0138523	A1	6/2011	Layson, Jr. et al.	
2011/0160691	A1	6/2011	Ng et al.	
2011/0203783	A1	8/2011	Blackford et al.	
2011/0214221	A1	9/2011	Munda	

FOREIGN PATENT DOCUMENTS

DE	9409799	4/1995
GB	2294426	5/1996
GB	2414960	12/2005
JP	63-125525	8/1988
JP	63-139147	9/1988
JP	204402/2004	7/2004
JP	2004338169	12/2004
KR	30560581	5/2010
WO	DM/064488	5/2003
WO	DM/064044	7/2003
WO	2006030254	3/2006
WO	DM/067876	5/2006

OTHER PUBLICATIONS

Quelle Catalog: RU, Jacket Advertisement, 2005.
 Sunmore, Poe Yoga Mat, Sporting Goods Buyers' Guide, Spring 2008.
 YPCYC Catalog, Kompendium: Sportmode, kettenwirk-praxis, Obertshausen, 2006.
 Castelli Insolito Radiation Jacket—3 Season Cycling Jacket; www.feedthehabit.com/road-biking/castelli-insolito-radiation-jacket-3-season-cycling-jacket/; Sep. 19, 2008.
 Castelli Radiation Jacket; www.cyclingweekly.co.uk/archive/tech/322662/castelli-radiation-jacket-300.html; Mar. 10, 2009.

* cited by examiner

Primary Examiner — Susan Bennet Hattan
 Assistant Examiner — Barbara B Lohr
 (74) Attorney, Agent, or Firm — Schwabe, Williamson & Wyatt, P.C.

(57) CLAIM

The ornamental design for a heat reflective material with pattern, as shown and described.

DESCRIPTION

FIG. 1 is a top view of the heat reflective material with pattern shown in use as on a jacket;
 FIG. 2 is a front view of the claimed design of FIG. 1;
 FIG. 3 is a bottom view of the claimed design of FIG. 1;
 FIG. 4 is a back view of the claimed design of FIG. 1;
 FIG. 5 is a right side view of the claimed design of FIG. 1;
 FIG. 6 is a left side view of the claimed design of FIG. 1;
 FIG. 7 is a right side view of the heat reflective material with pattern shown in use as on a boot;
 FIG. 8 is a front view of the claimed design as shown in FIG. 7;
 FIG. 9 is a back view of the claimed design as shown in FIG. 7;
 FIG. 10 is a right side view of the claimed design as shown in FIG. 7;
 FIG. 11 is a top view of the claimed design as shown in FIG. 7;
 FIG. 12 is a bottom view of the claimed design as shown in FIG. 7;
 FIG. 13 is a right side view of the heat reflective material with pattern shown in use as on a glove;
 FIG. 14 is a left side view of the claimed design as shown in FIG. 13;
 FIG. 15 is a bottom view of the claimed design as shown in FIG. 13;
 FIG. 16 is a top view of the claimed design as shown in FIG. 13;
 FIG. 17 is a back view of the claimed design as shown in FIG. 13;
 FIG. 18 is a front view of the claimed design as shown in FIG. 13;
 FIG. 19 is a front view of the heat reflective material with pattern shown in use as on a hat;
 FIG. 20 is a bottom view of the claimed design as shown in FIG. 19;
 FIG. 21 is a left side view of the claimed design as shown in FIG. 19;
 FIG. 22 is a right side view of the claimed design as shown in FIG. 19;
 FIG. 23 is a top view of the claimed design as shown in FIG. 19;
 FIG. 24 is a back view of the claimed design as shown in FIG. 19;
 FIG. 25 is a front view of the heat reflective material with pattern shown in use as on pants;
 FIG. 26 is a back view of the claimed design as shown in FIG. 25;
 FIG. 27 is a bottom view of the claimed design as shown in FIG. 25;
 FIG. 28 is a top view of the claimed design as shown in FIG. 25;
 FIG. 29 is a right side view of the claimed design as shown in FIG. 25;

FIG. 30 is a left side view of the claimed design as shown in FIG. 25;

FIG. 31 is a left side view of the heat reflective material with pattern shown in use as on a sock;

FIG. 32 is a front view of the claimed design as shown in FIG. 31;

FIG. 33 is a top view of the claimed design as shown in FIG. 31;

FIG. 34 is a right side view of the claimed design as shown in FIG. 31;

FIG. 35 is a back view of the claimed design as shown in FIG. 31;

FIG. 36 is a bottom view of the claimed design as shown in FIG. 31;

FIG. 37 is a front view of the heat reflective material with pattern shown in use as on a sleeping bag.

FIG. 38 is a back view of the claimed design as shown in FIG. 37;

FIG. 39 is a top view of the claimed design as shown in FIG. 37;

FIG. 40 is a right side view of the claimed design as shown in FIG. 37;

FIG. 41 is a left side view of the claimed design as shown in FIG. 37;

FIG. 42 is a bottom view of the claimed design as shown in FIG. 37;

FIG. 43 is a left side view of the heat reflective material with pattern shown in use as on a boot;

FIG. 44 is a top view of the claimed design as shown in FIG. 43;

FIG. 45 is a bottom view of the claimed design as shown in FIG. 43;

FIG. 46 is a right side view of the claimed design as shown in FIG. 43;

FIG. 47 is a back view of the claimed design as shown in FIG. 43; and,

FIG. 48 is a front view of the claimed design as shown in FIG. 43.

The dashed lines are included for illustrating environmental structure and form no part of the claimed design.

1 Claim, 15 Drawing Sheets

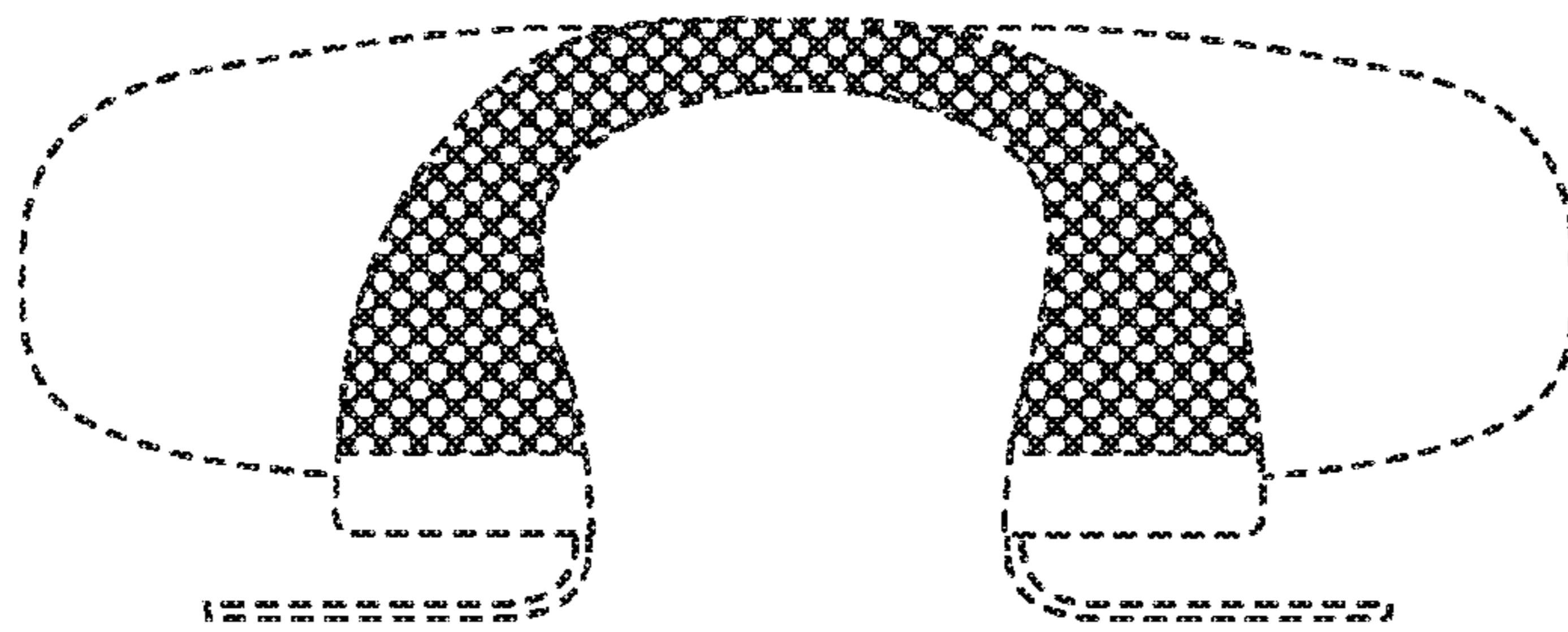

FIG. 1

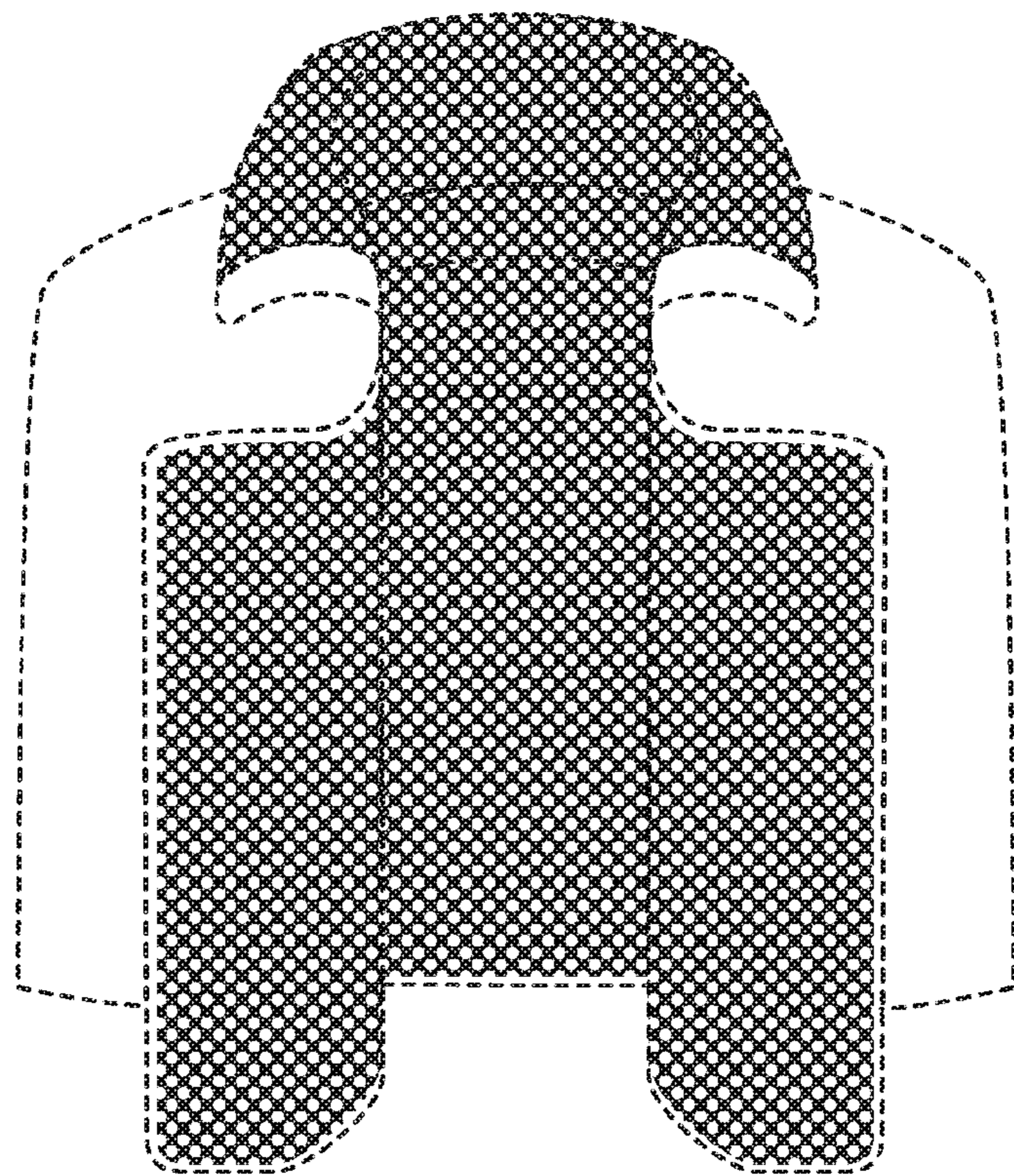

FIG. 2

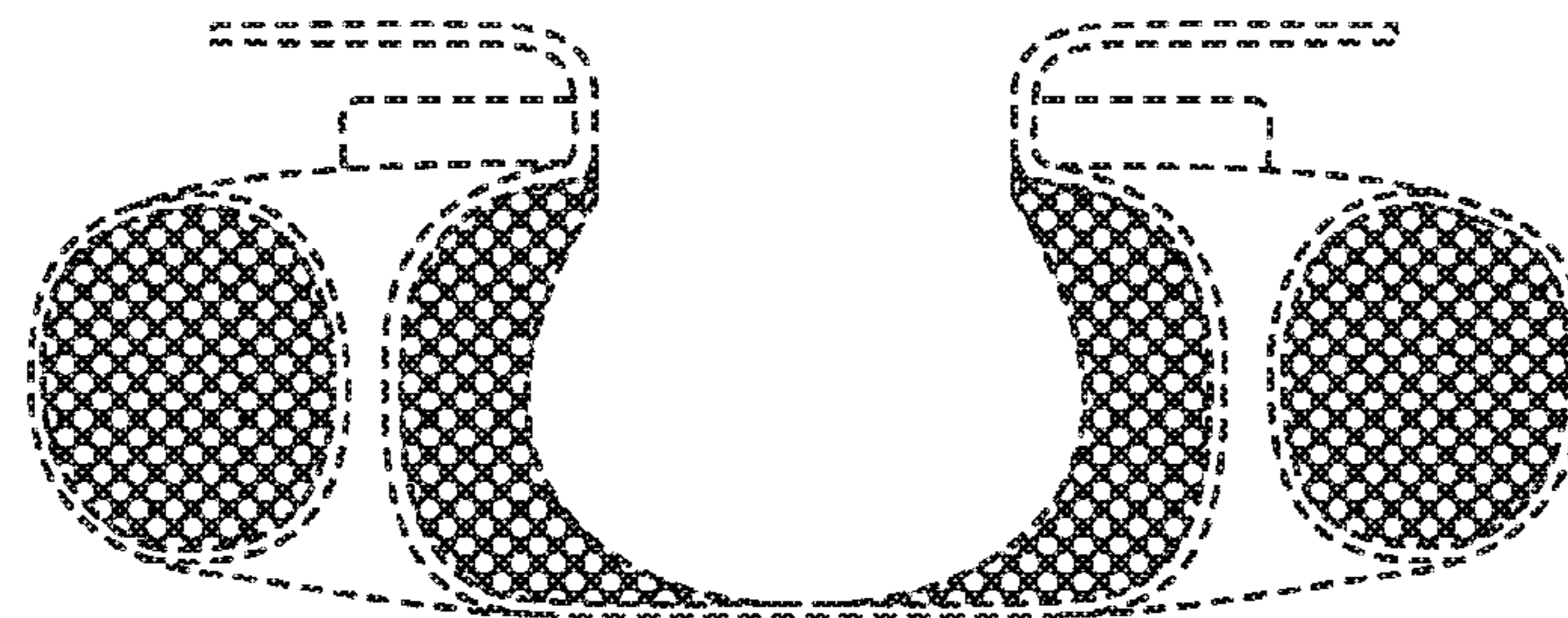

FIG. 3

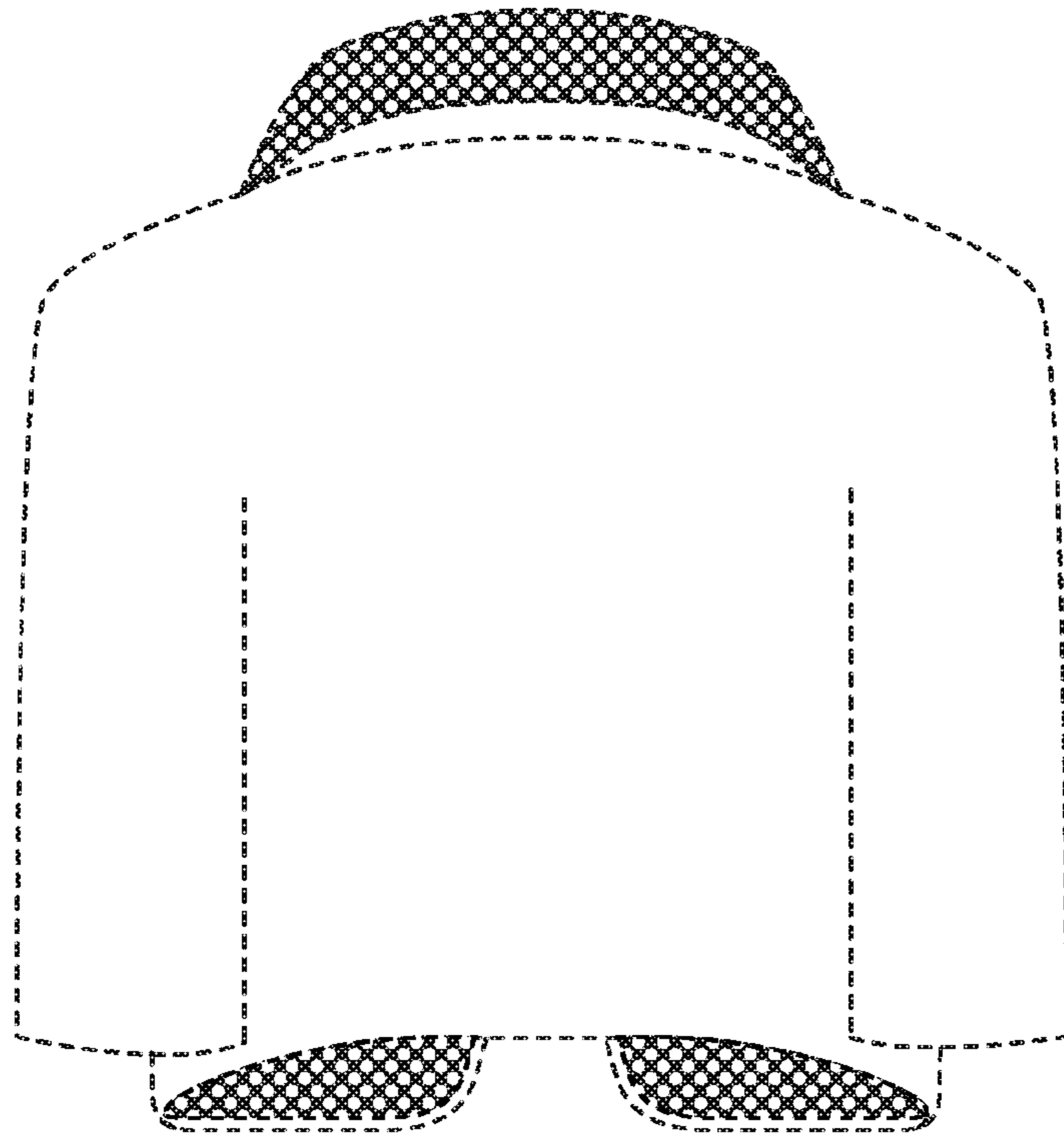

FIG. 4

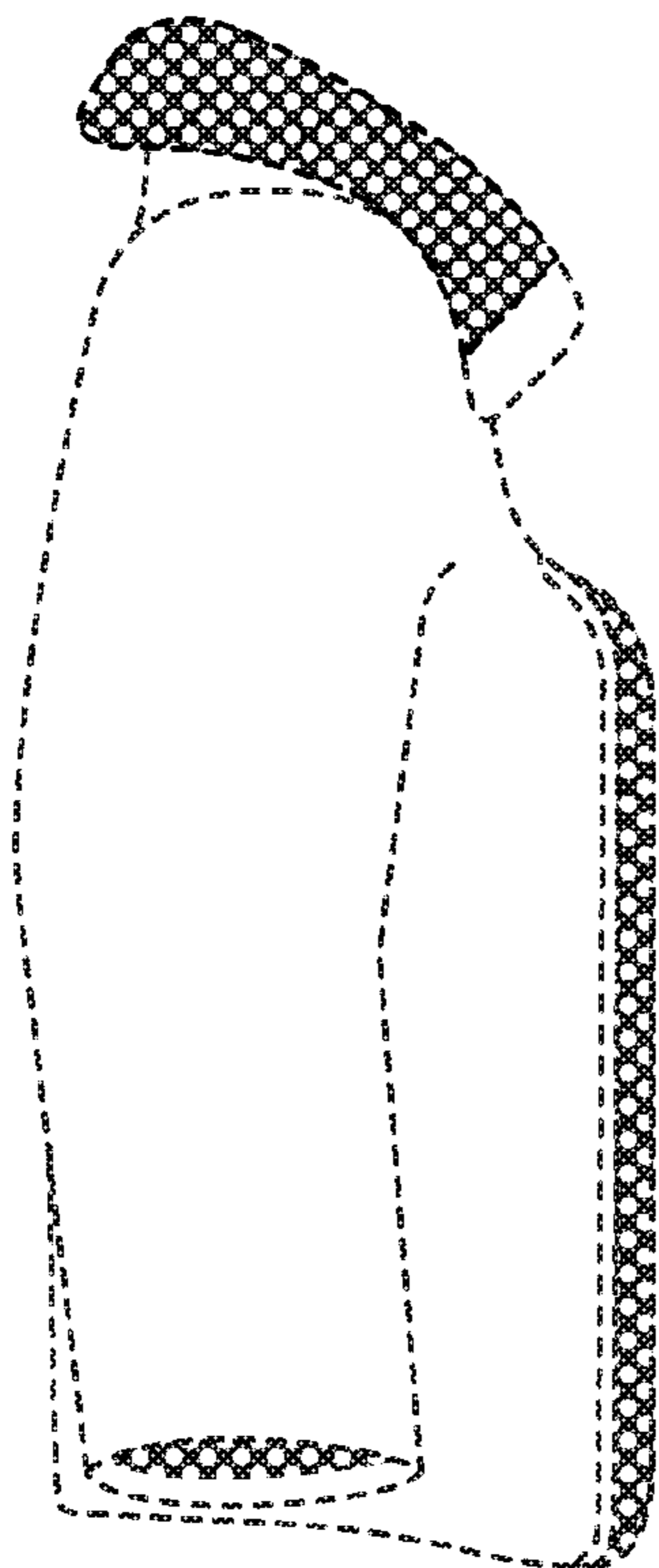

FIG. 5

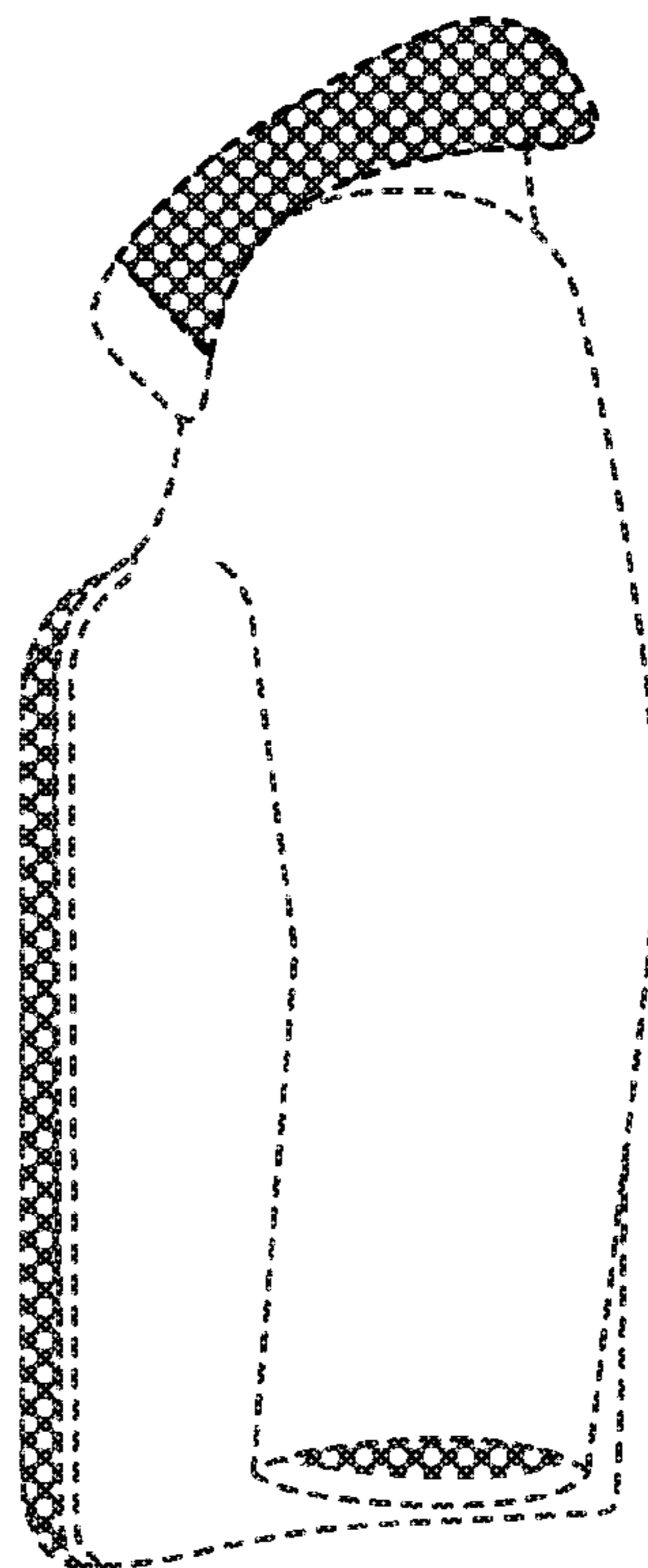

FIG. 6

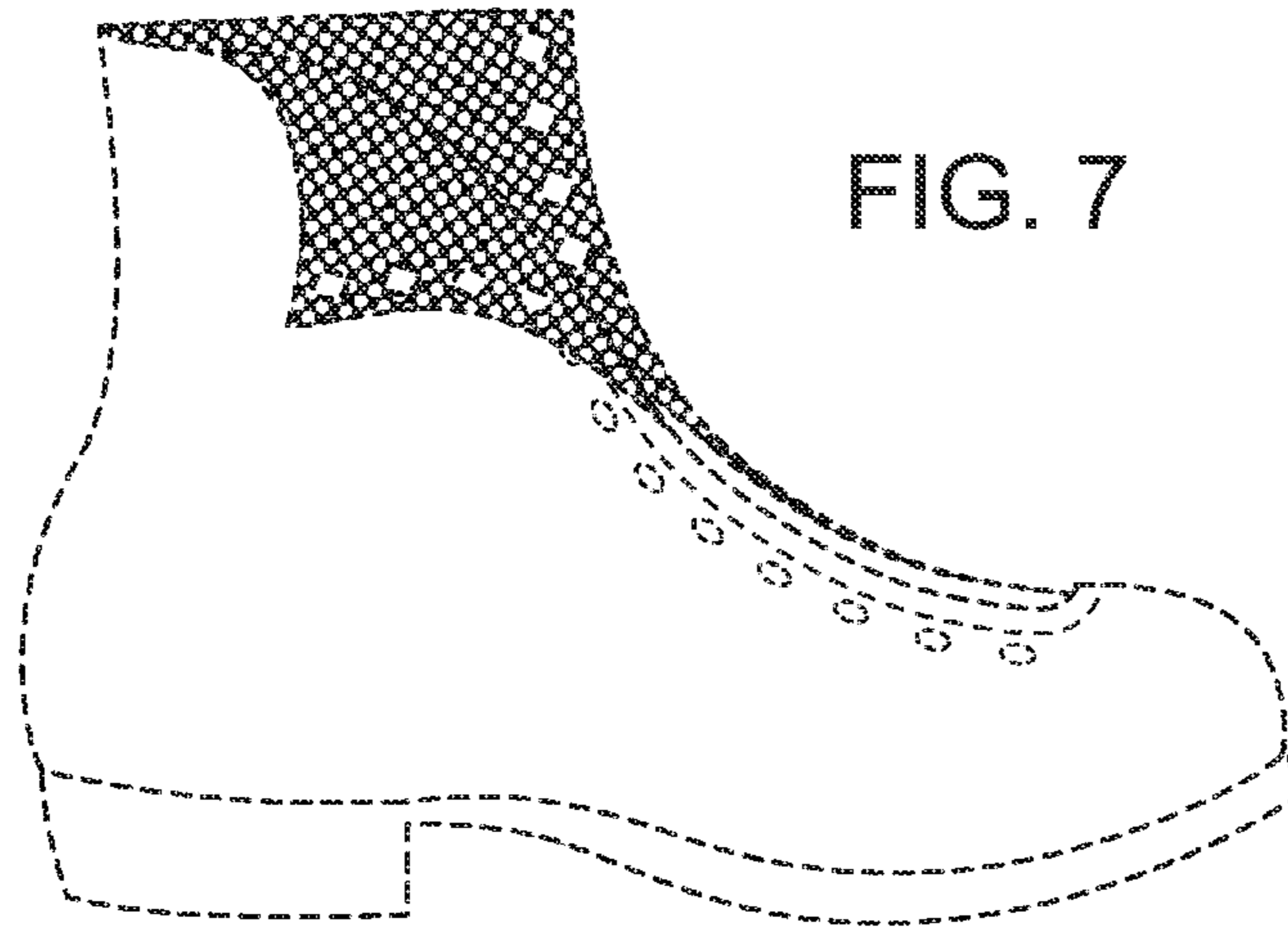

FIG. 7

FIG. 8

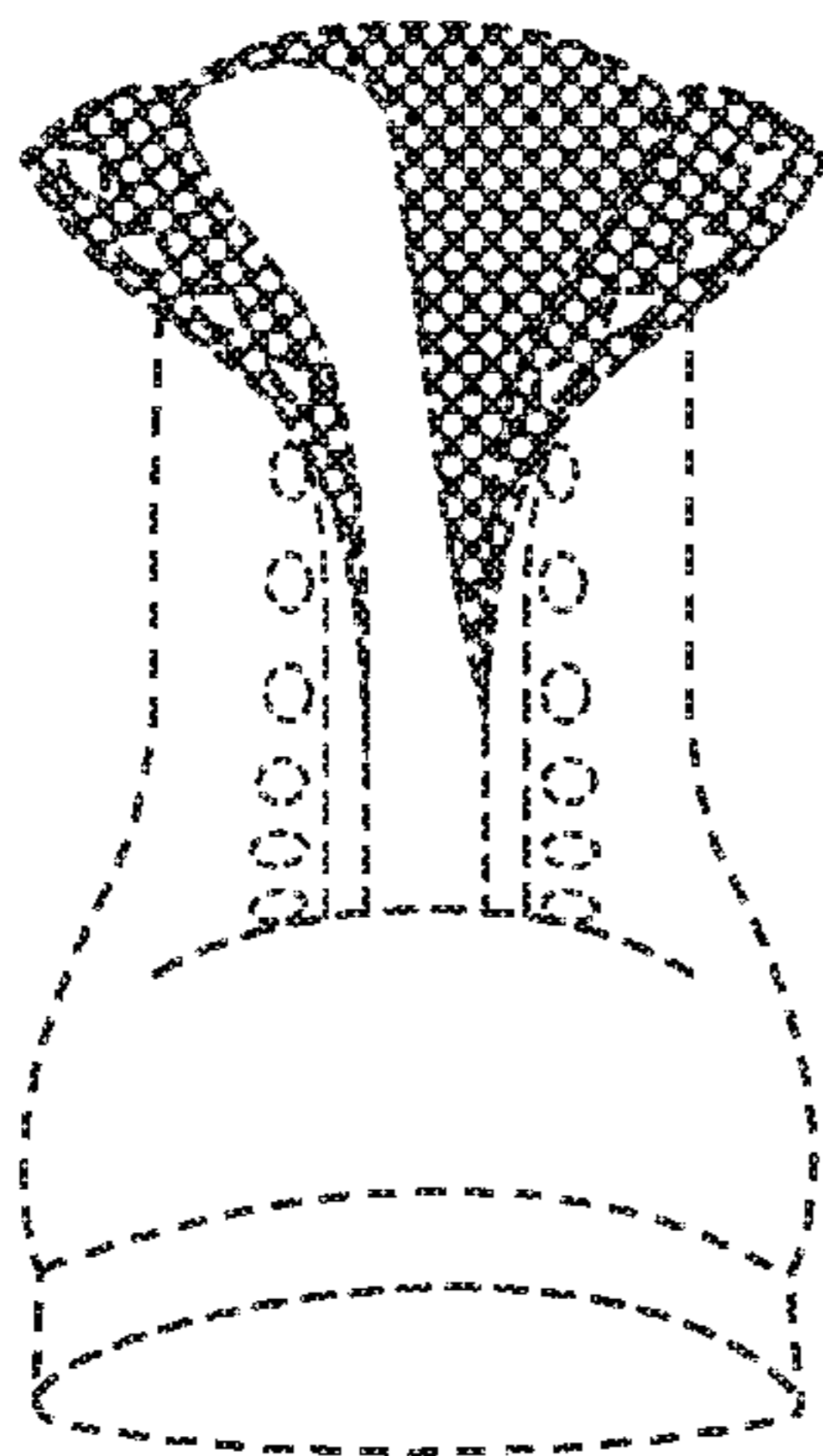

FIG. 9

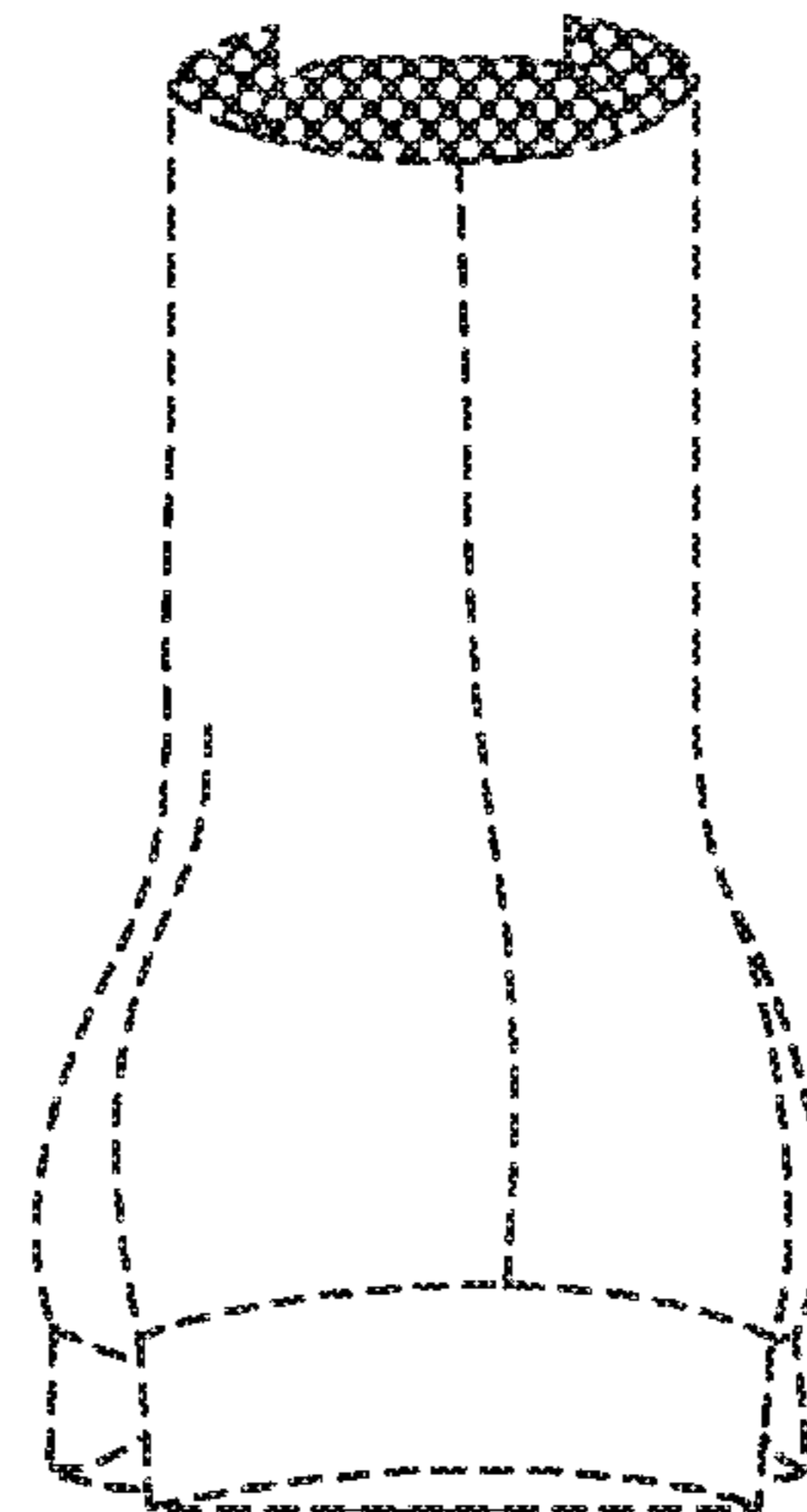

FIG. 10

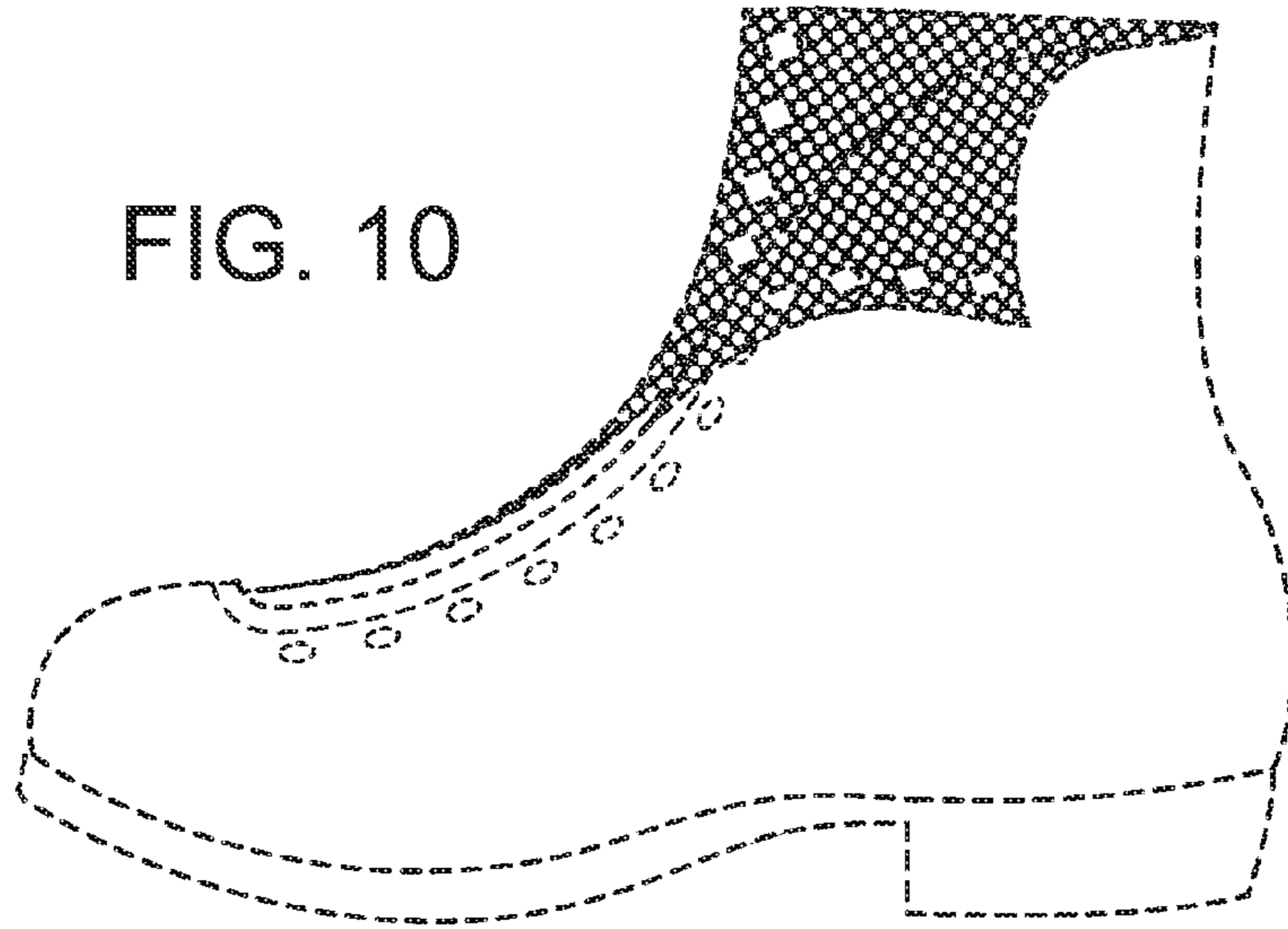

FIG. 11

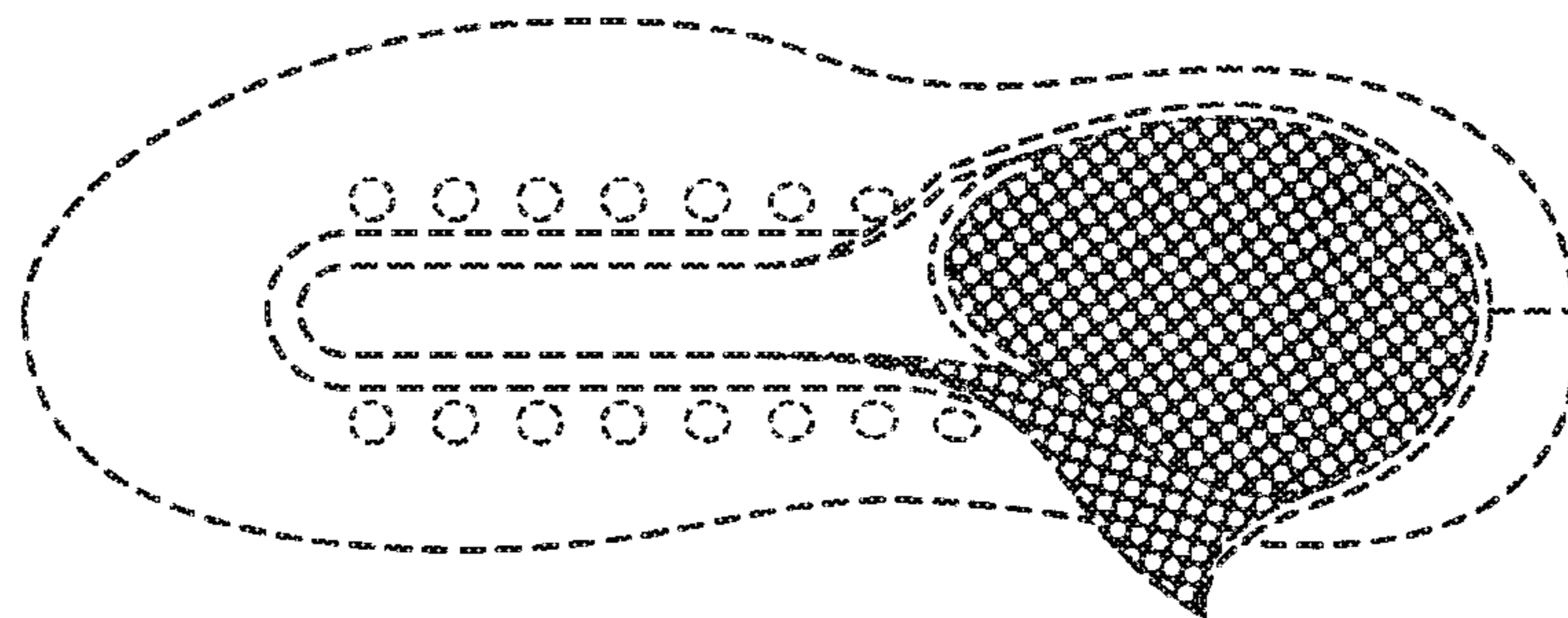

FIG. 12

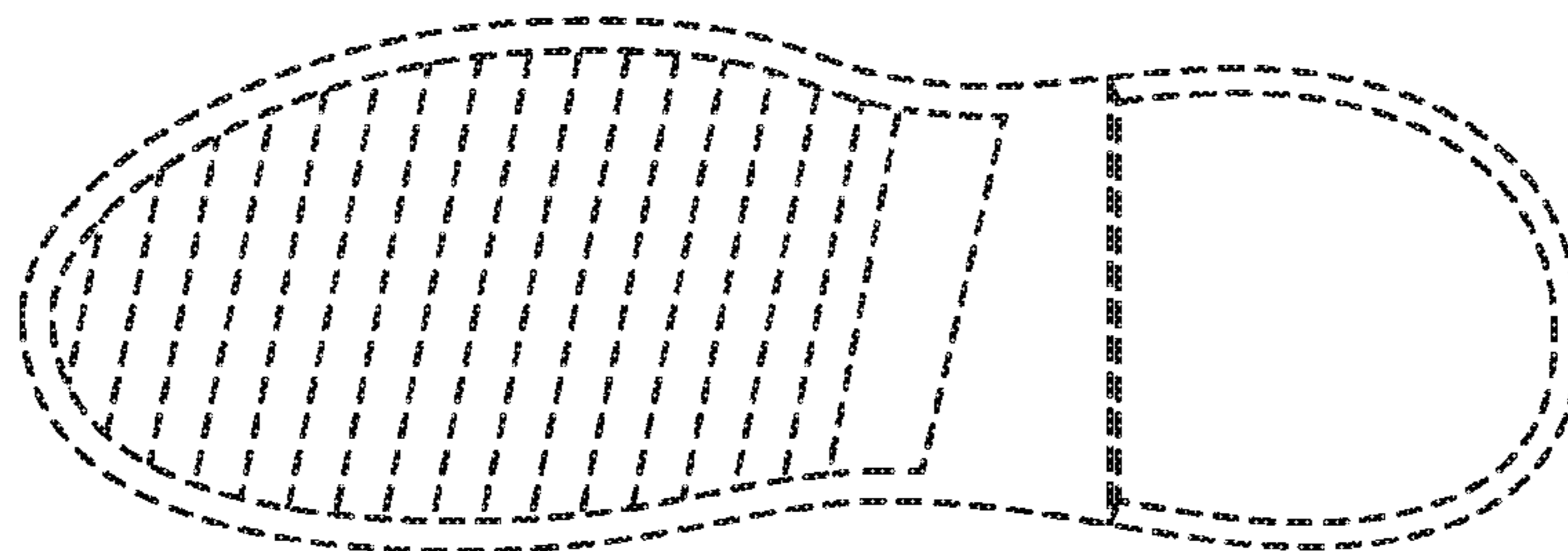

FIG. 13

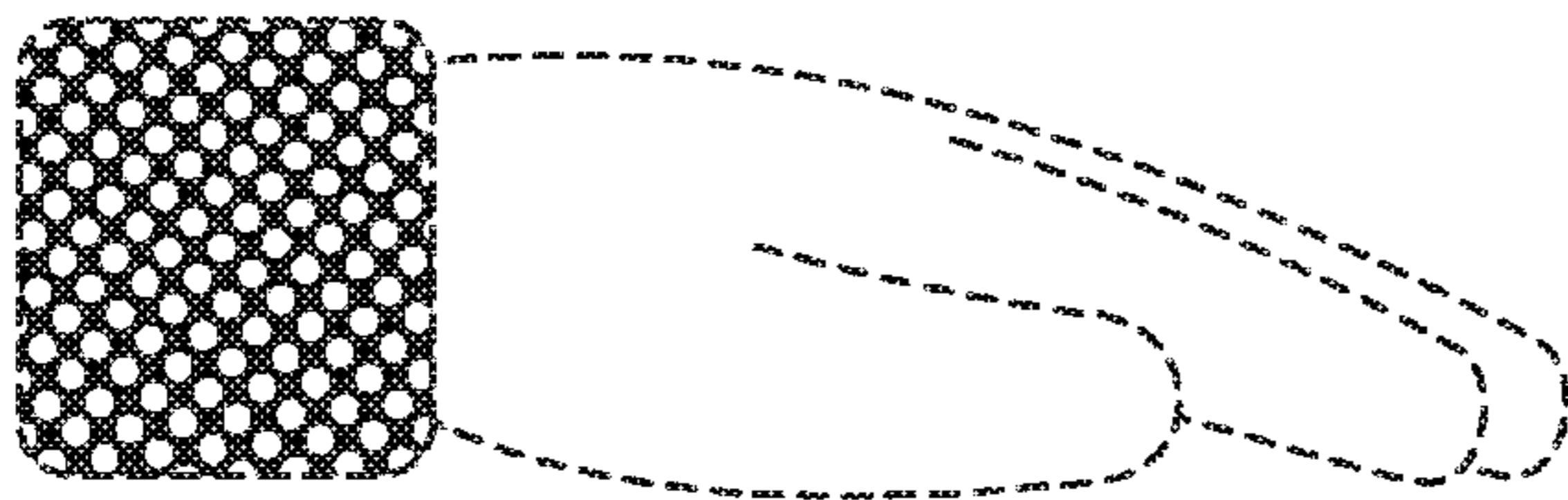

FIG. 17



FIG. 14

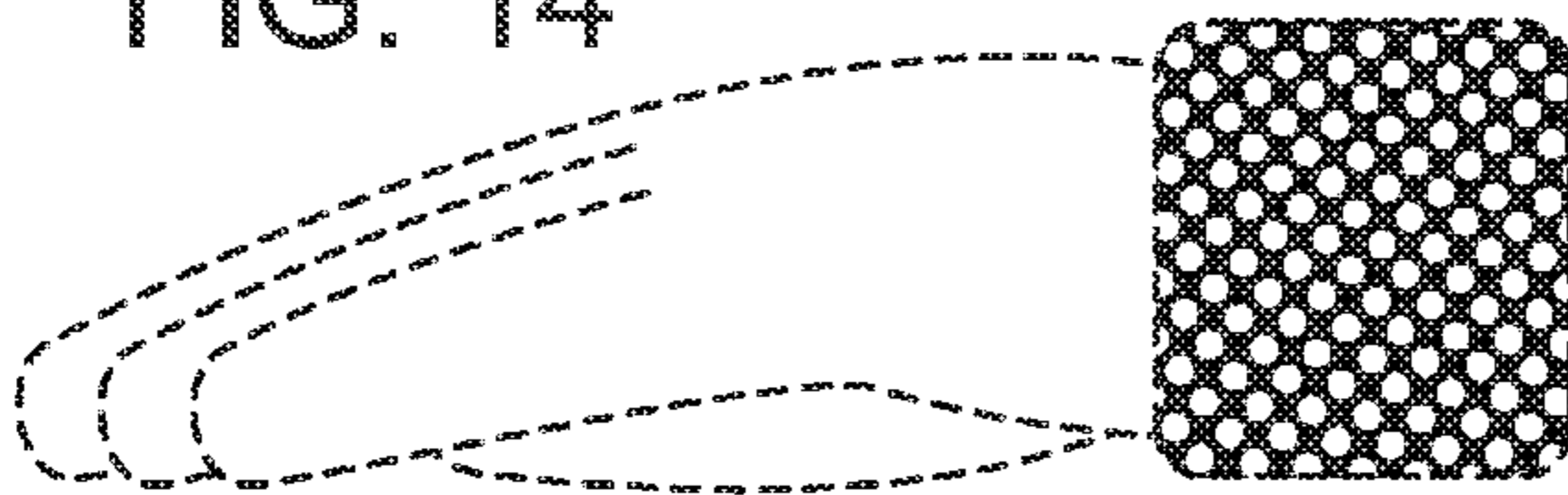

FIG. 15

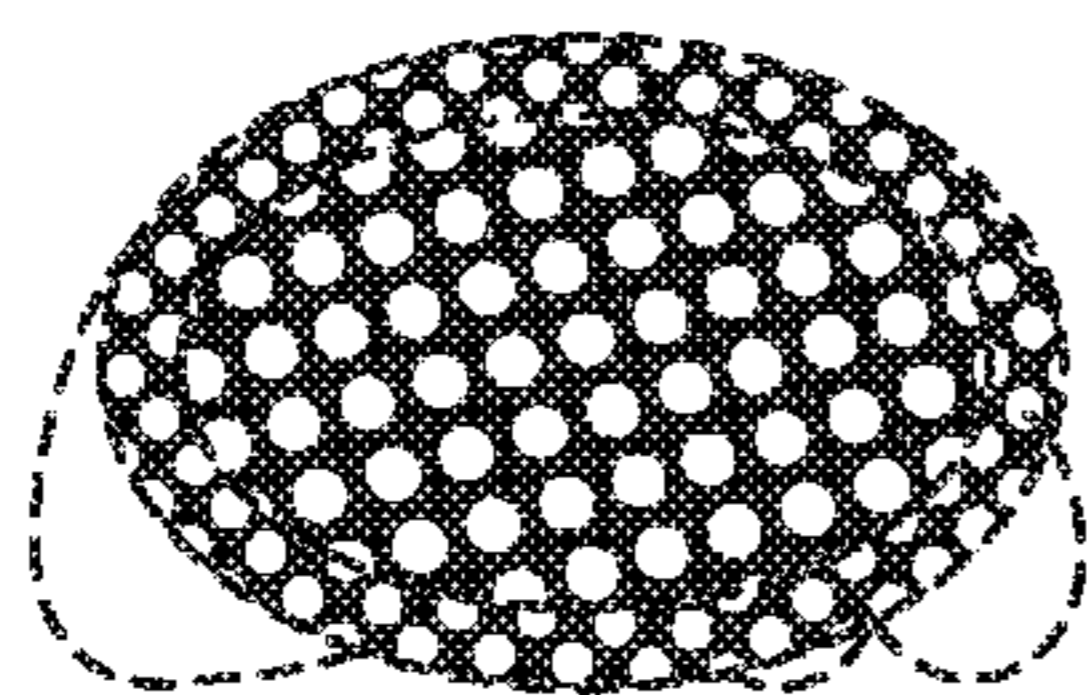

FIG. 18



FIG. 16

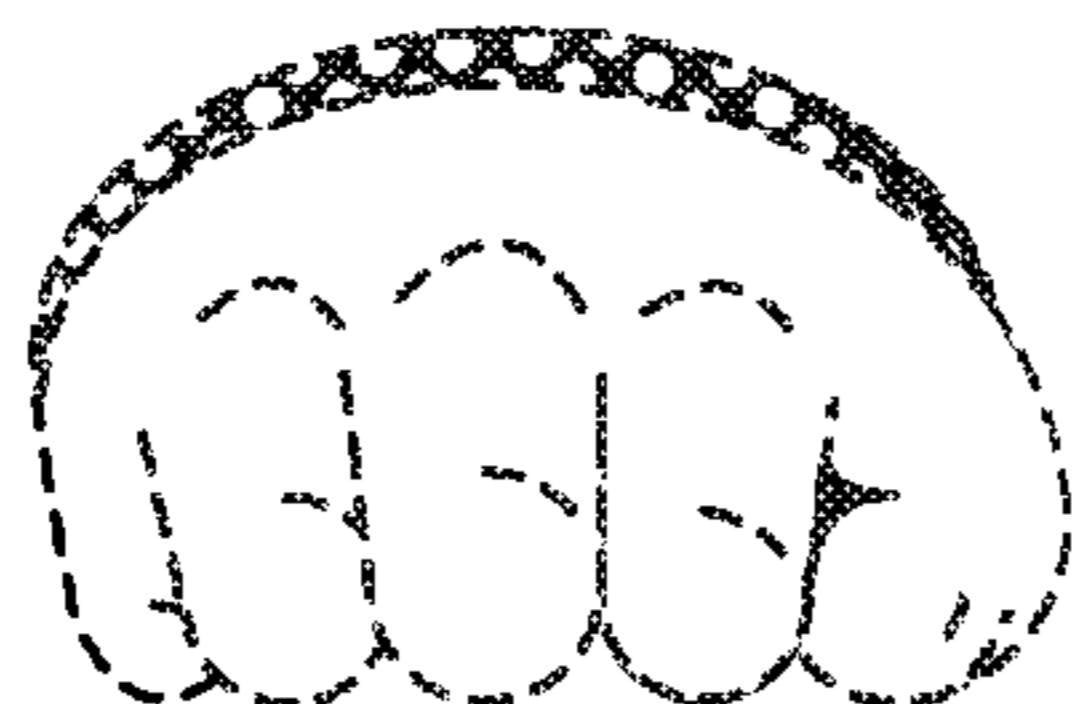

FIG. 19

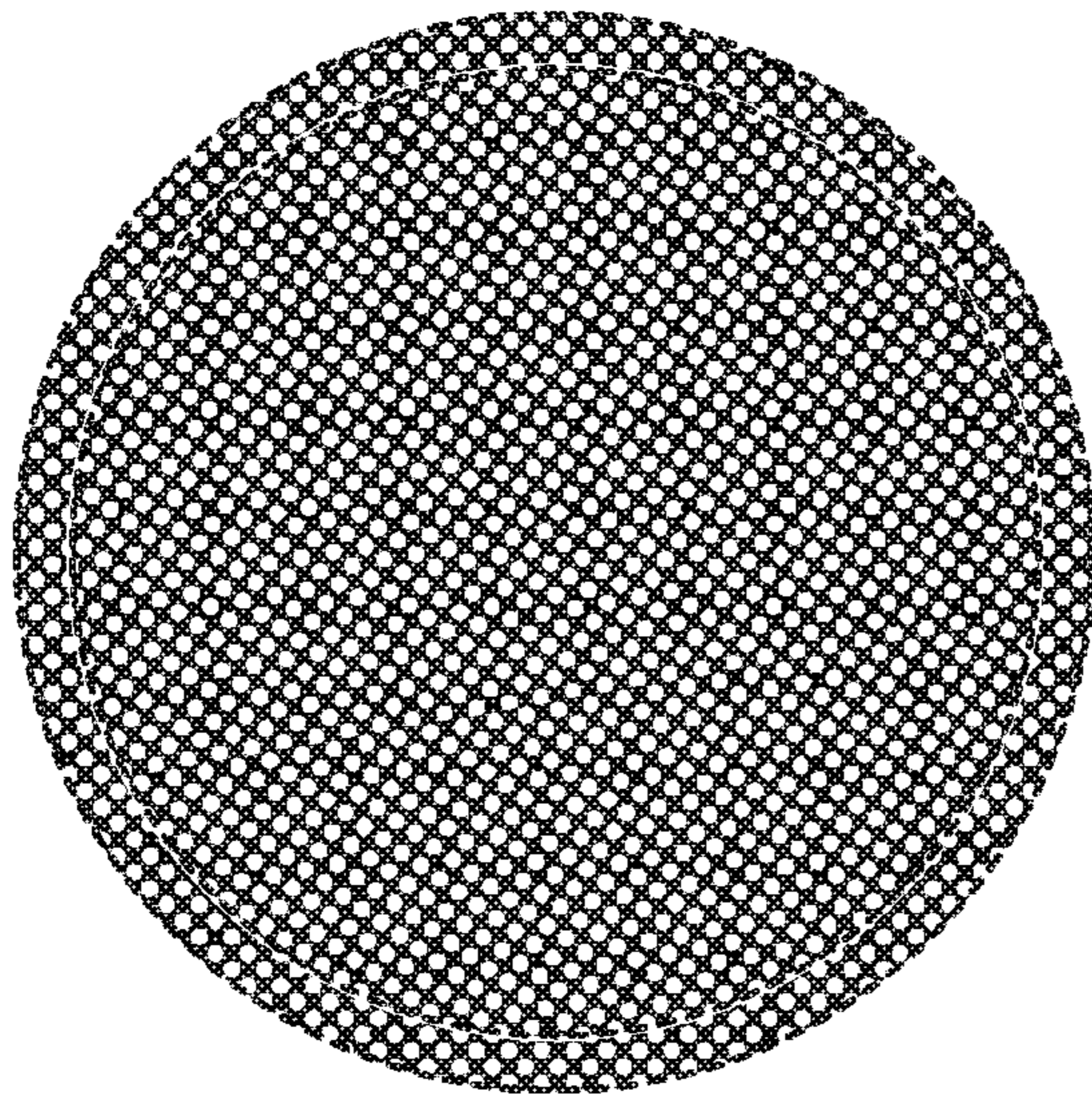
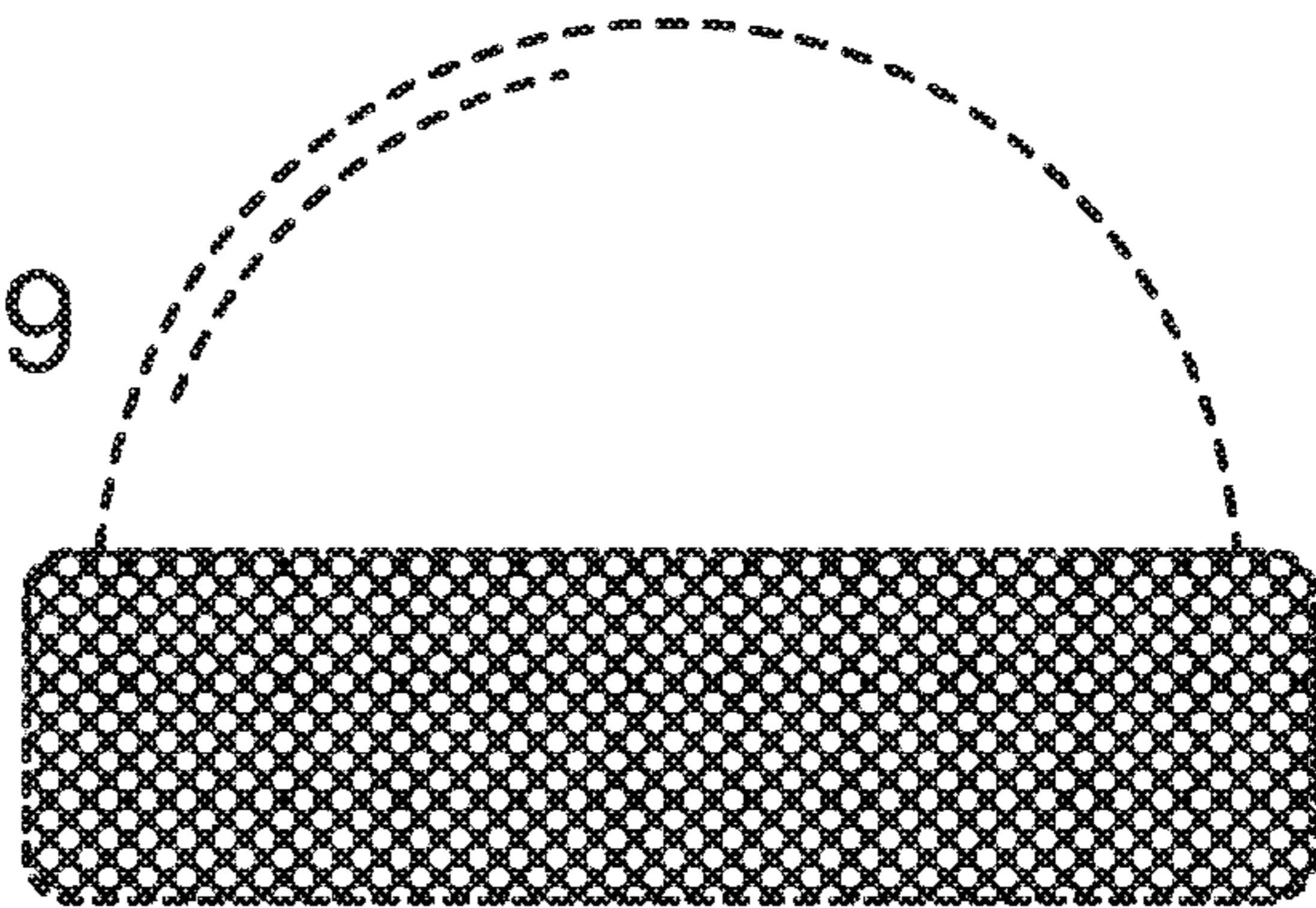

FIG. 20

FIG. 21

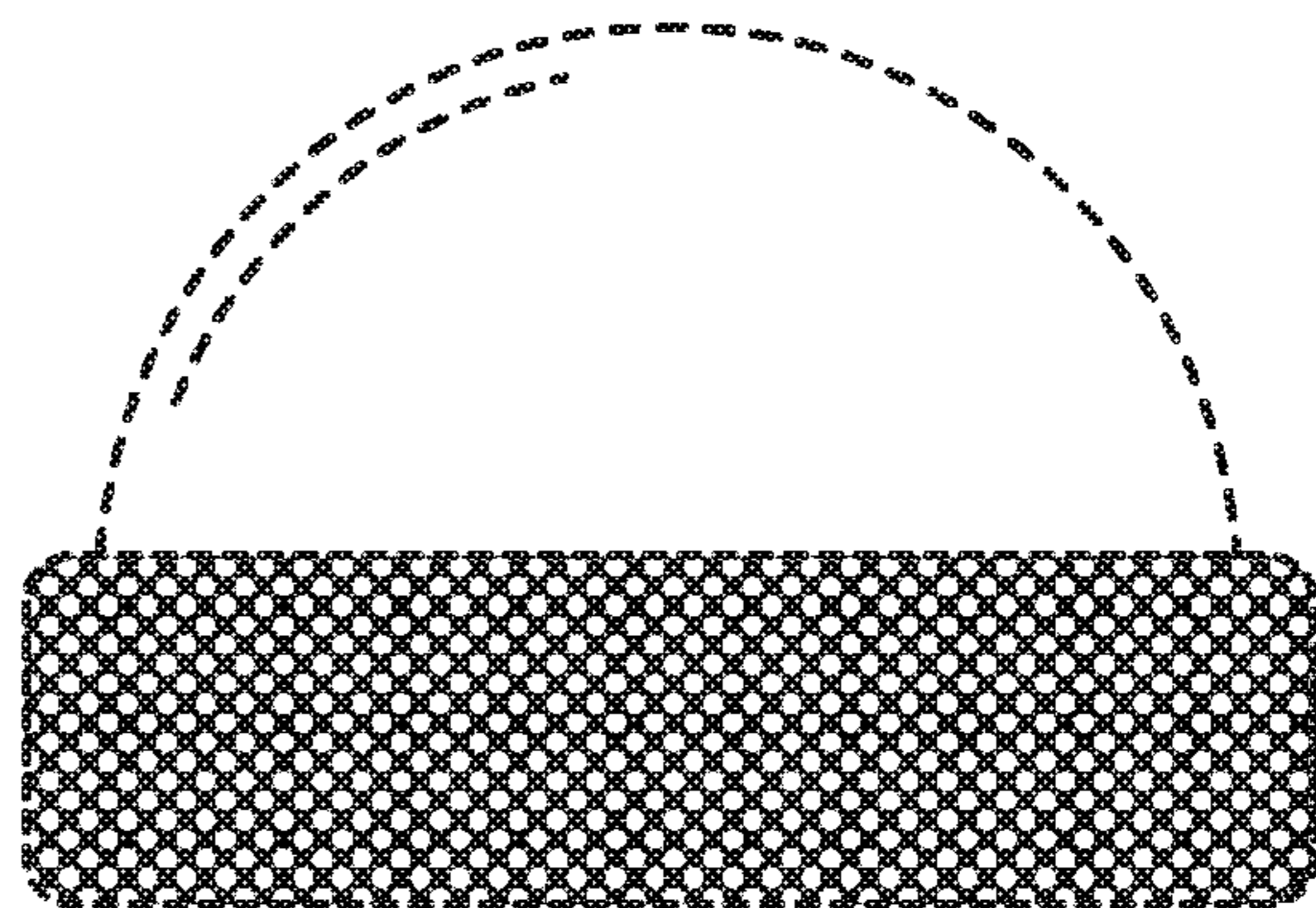

FIG. 22

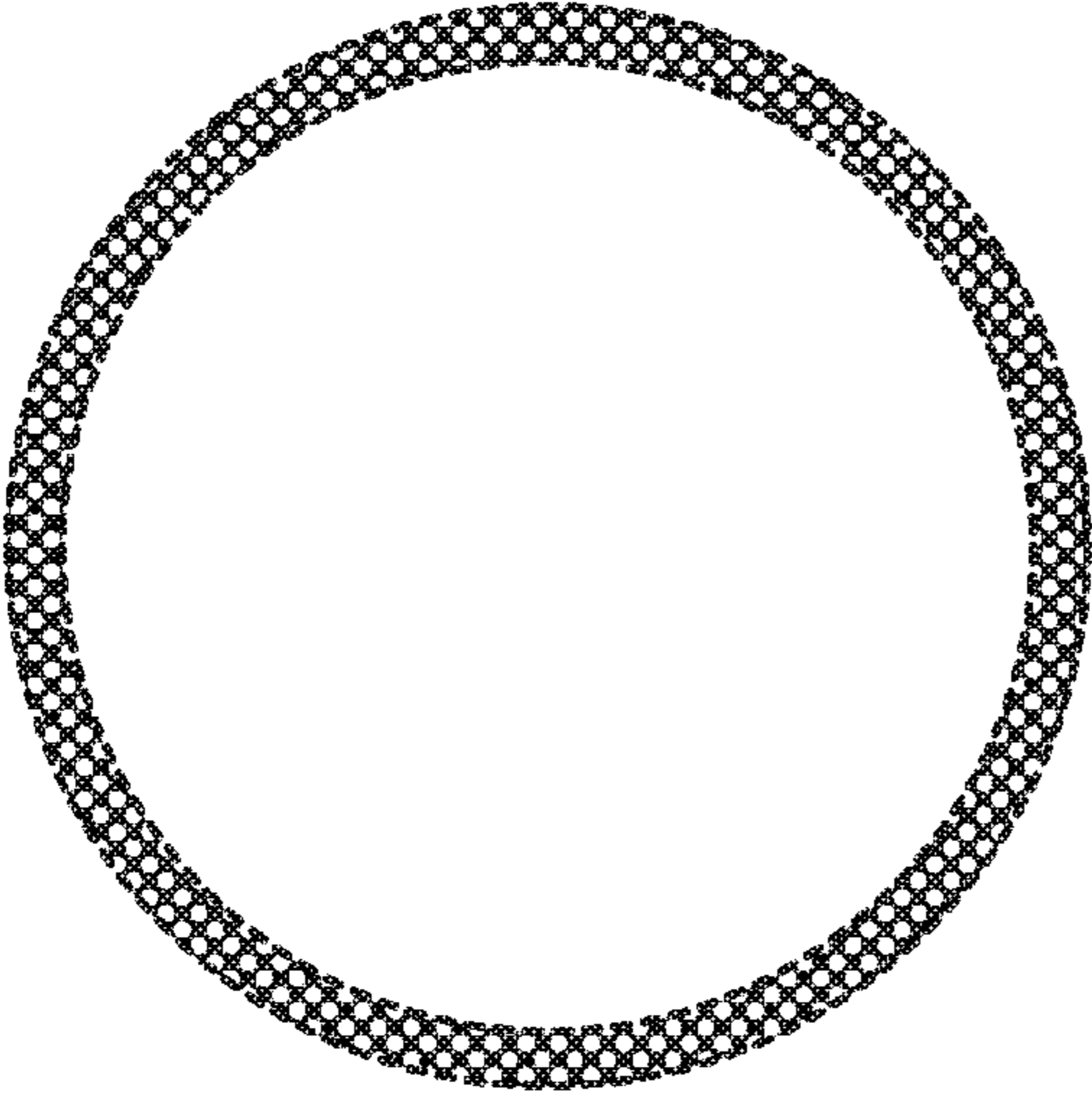
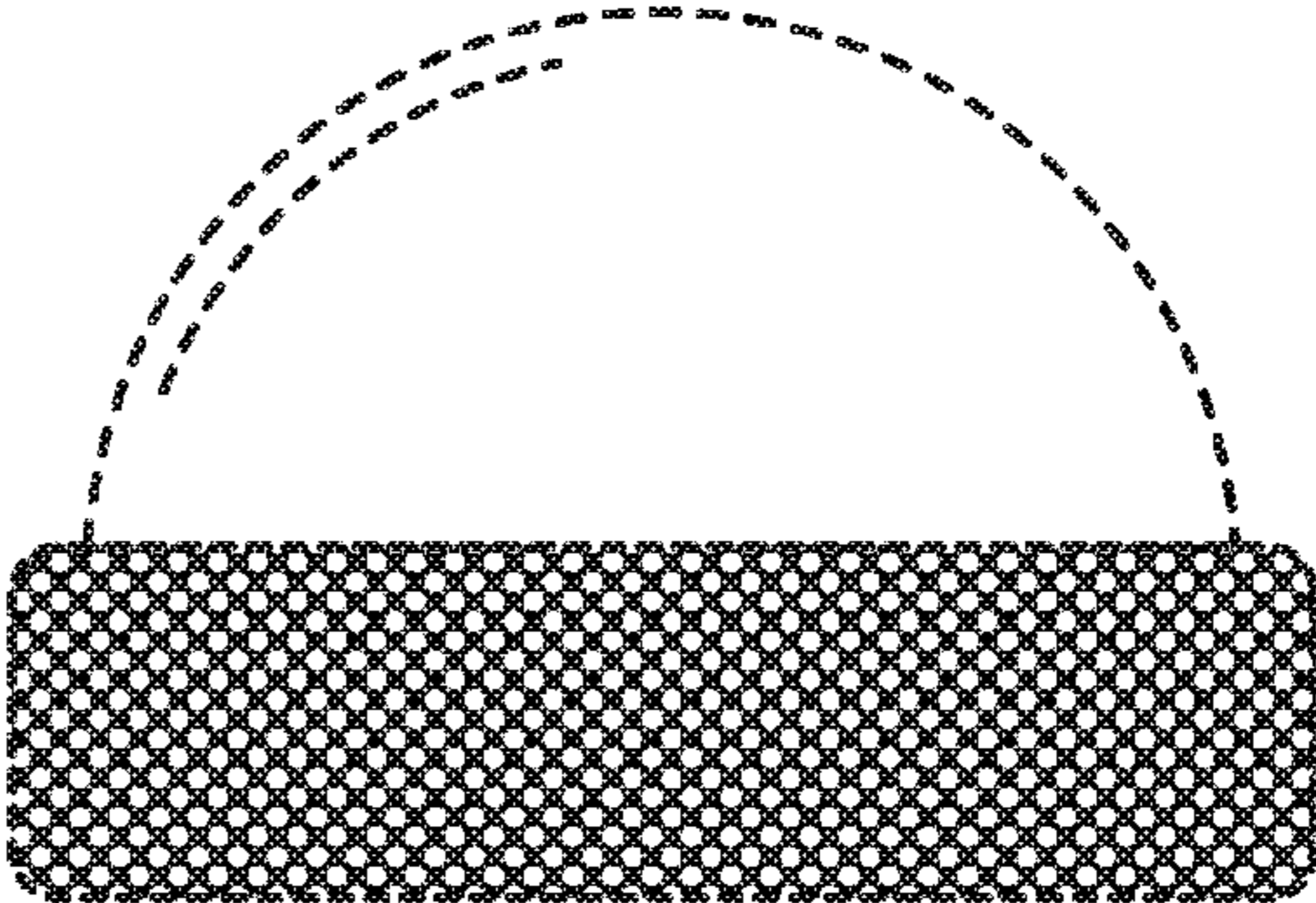

FIG. 23

FIG. 24

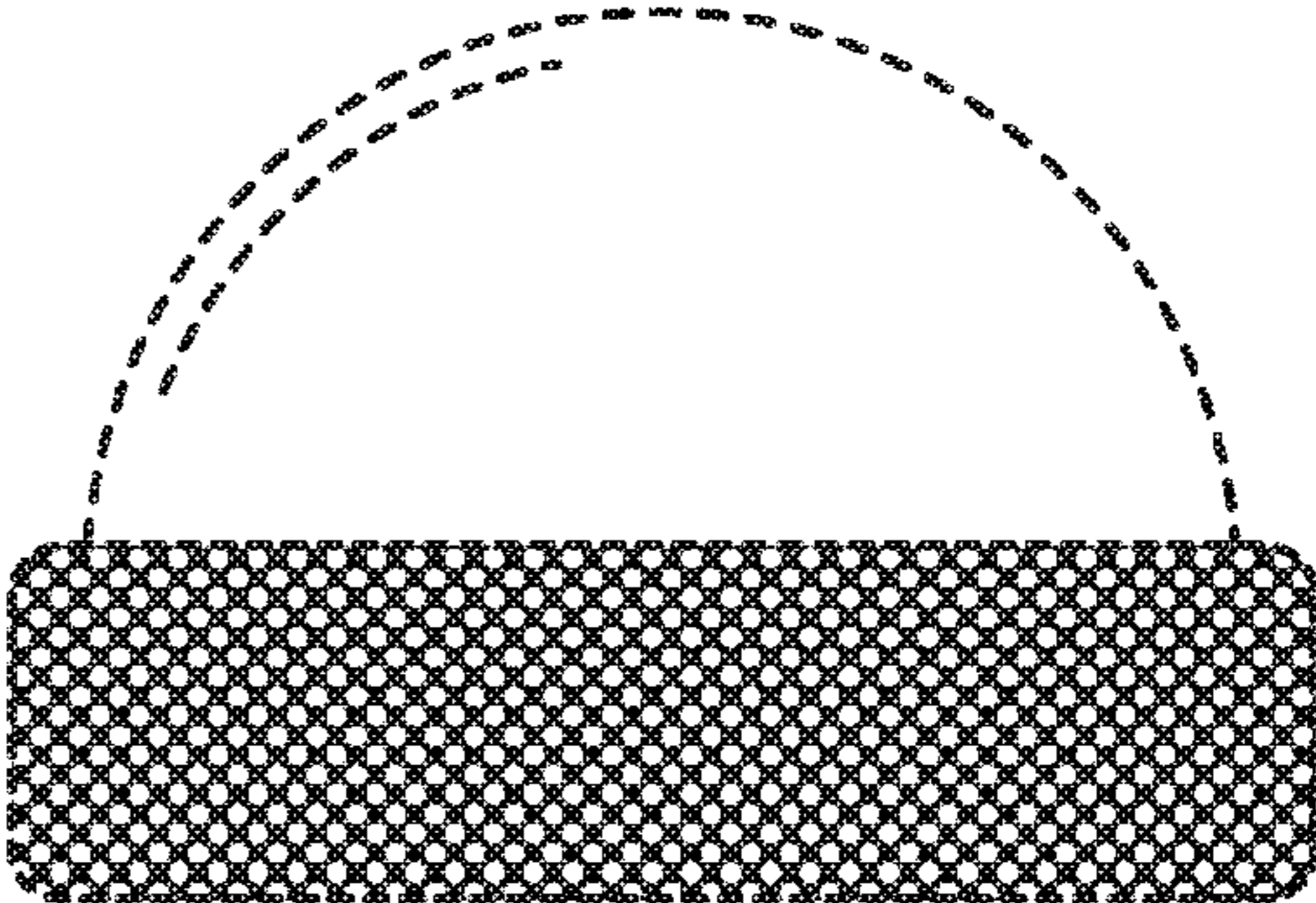

FIG. 25

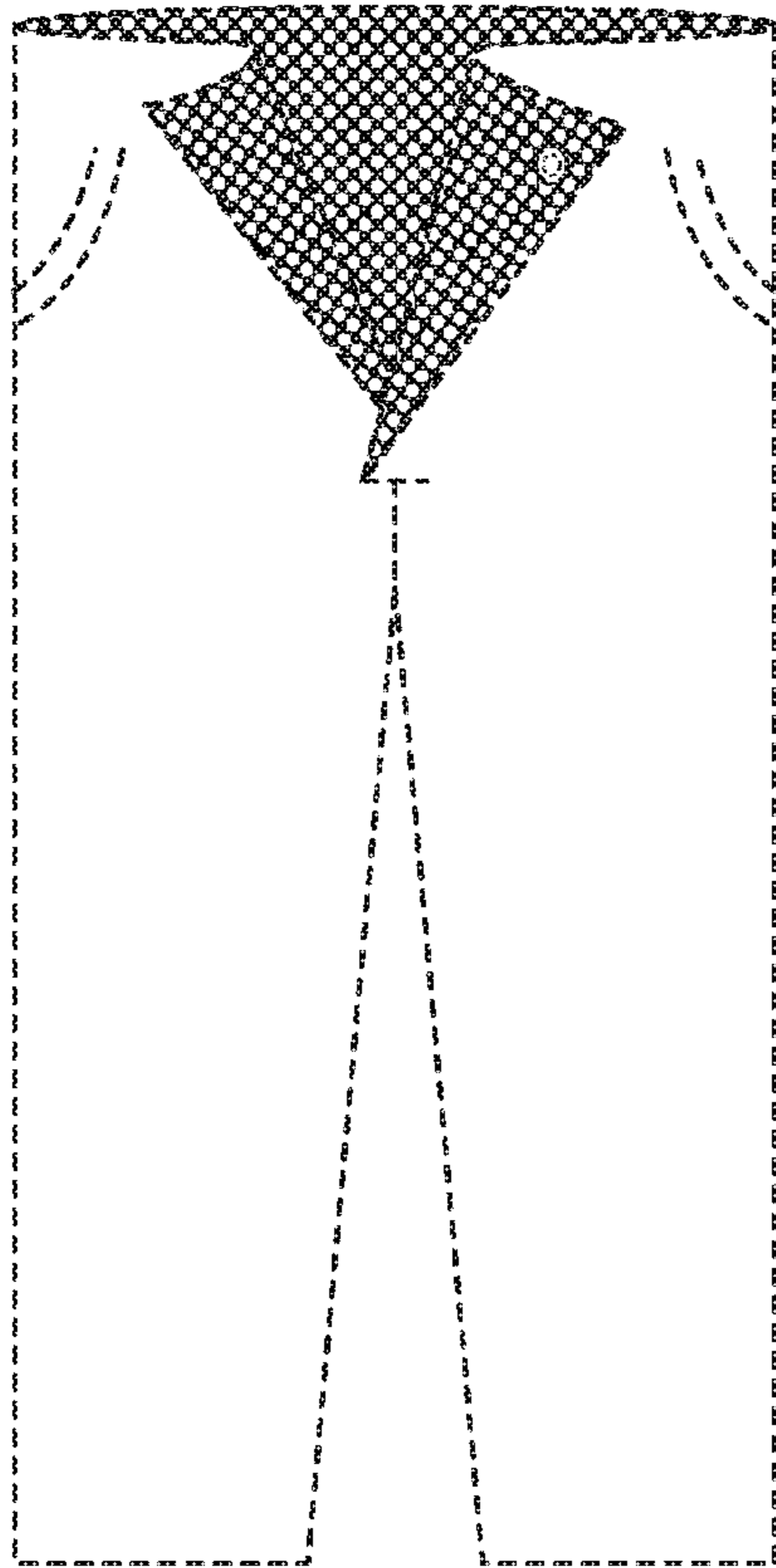

FIG. 26

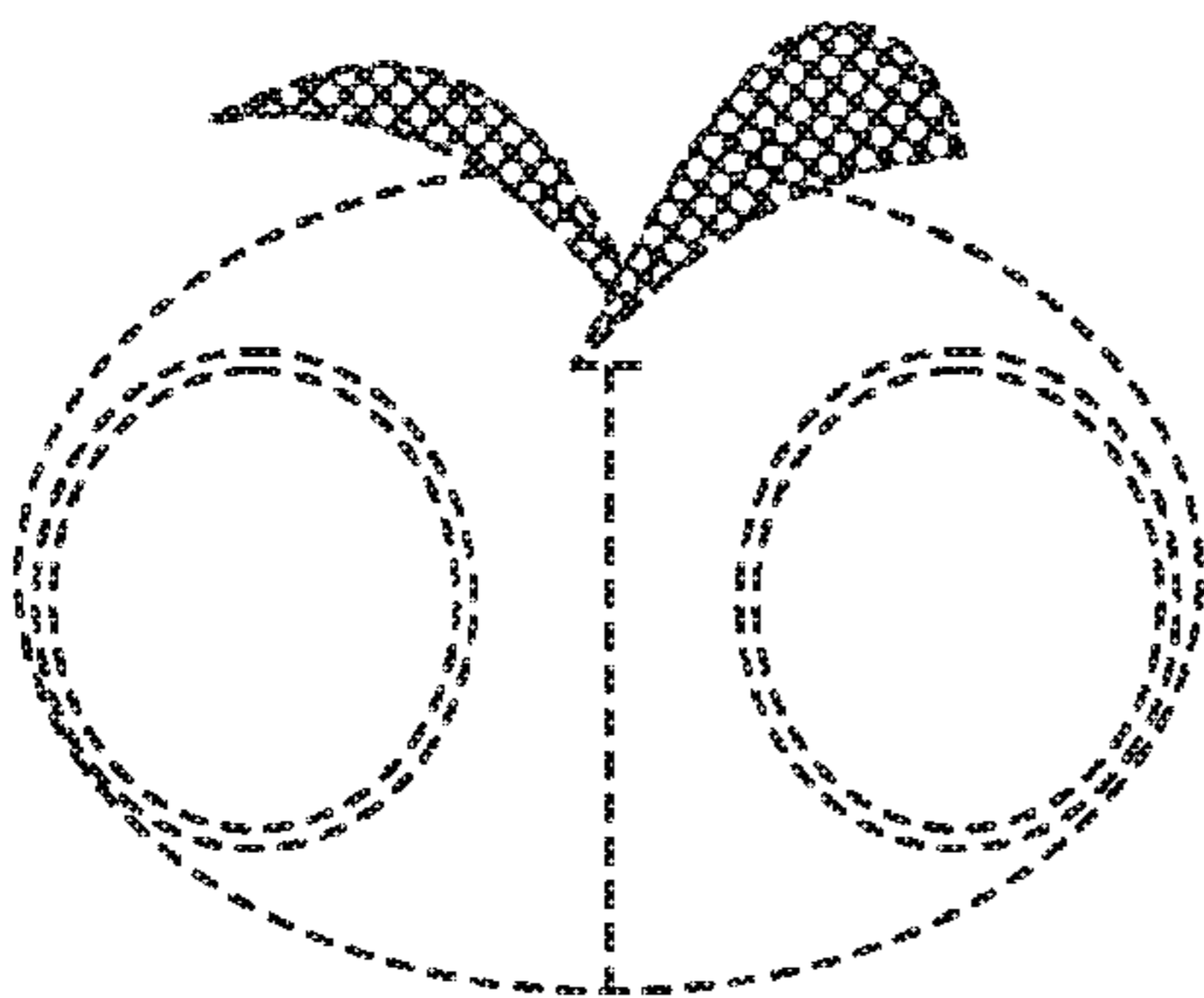
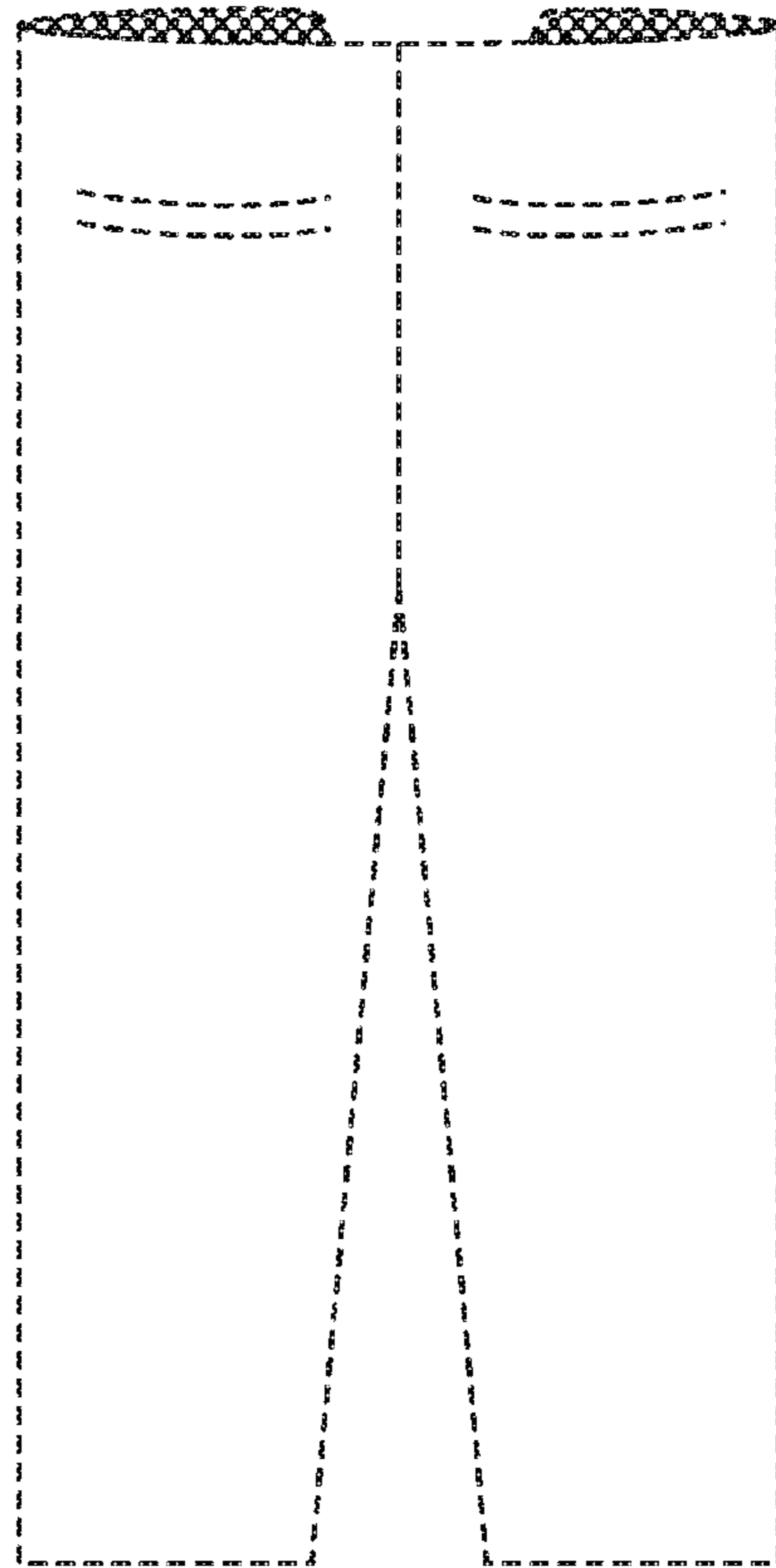

FIG. 27

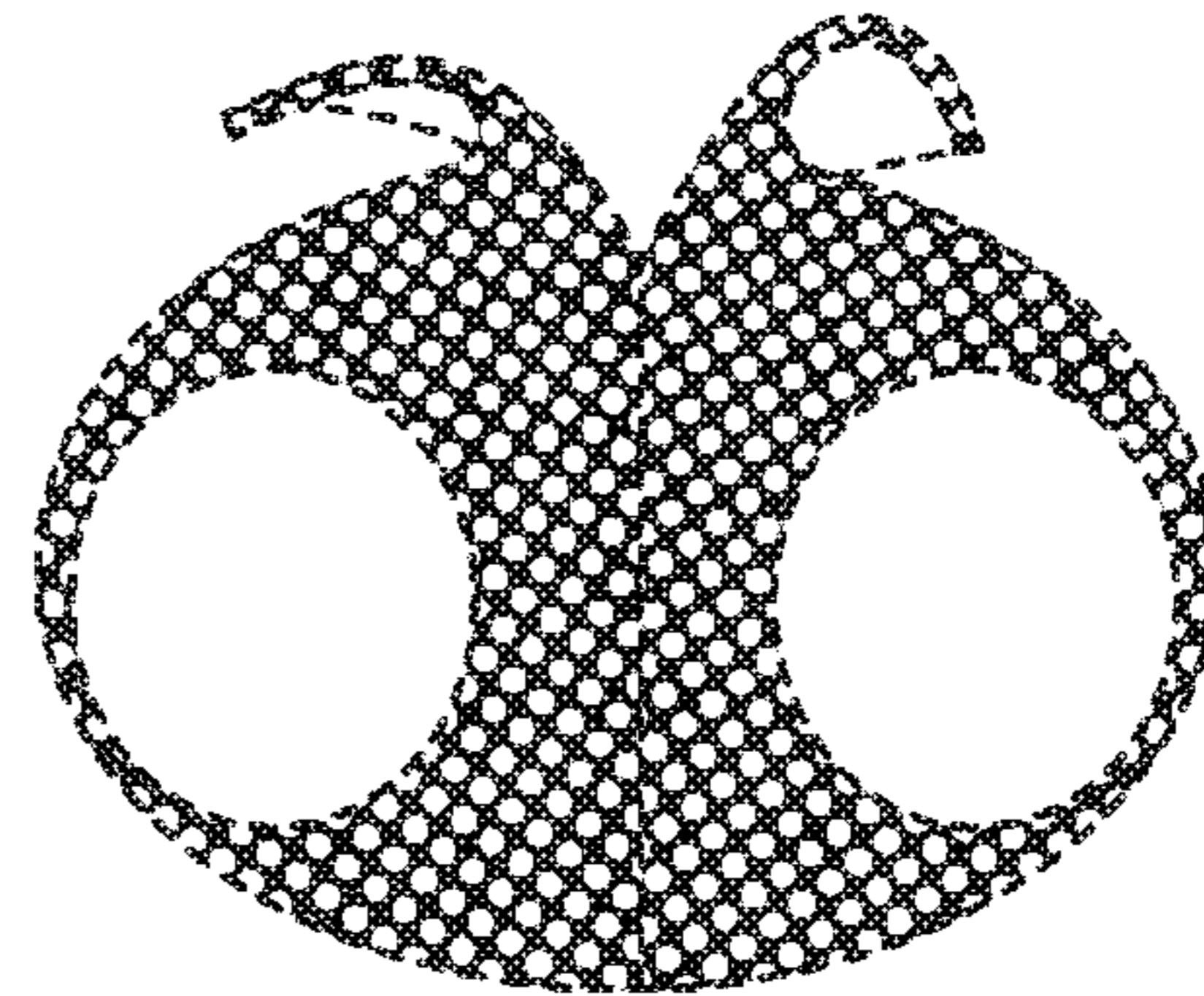

FIG. 28

FIG. 29

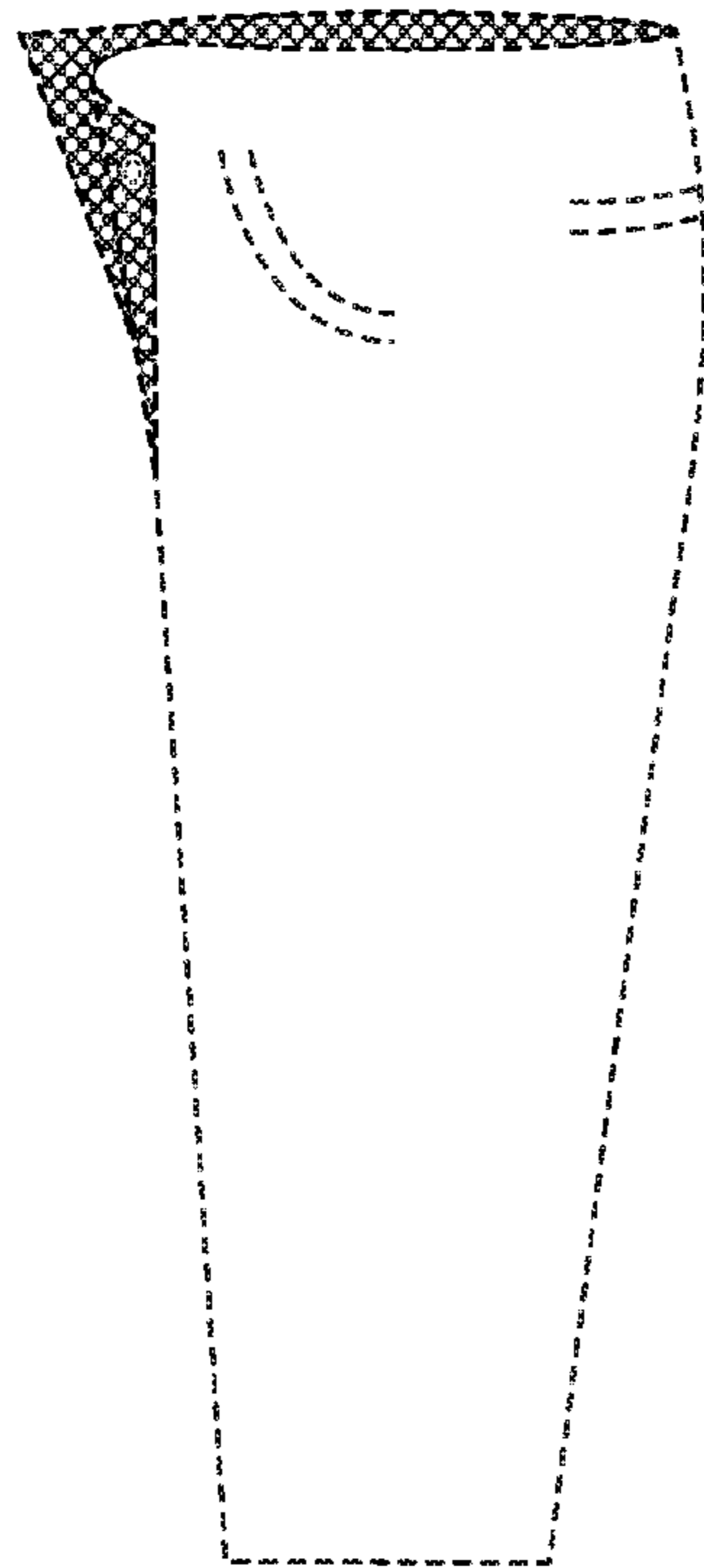
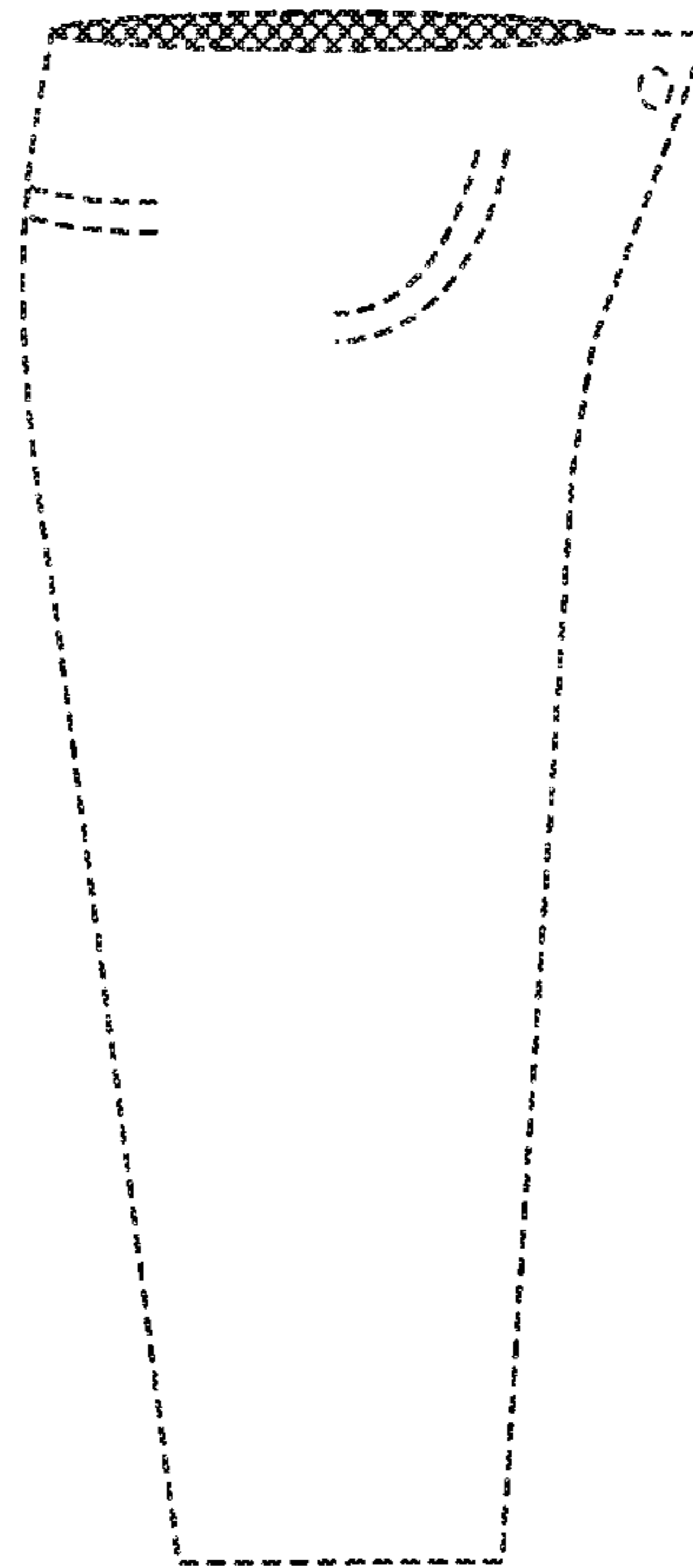

FIG. 30



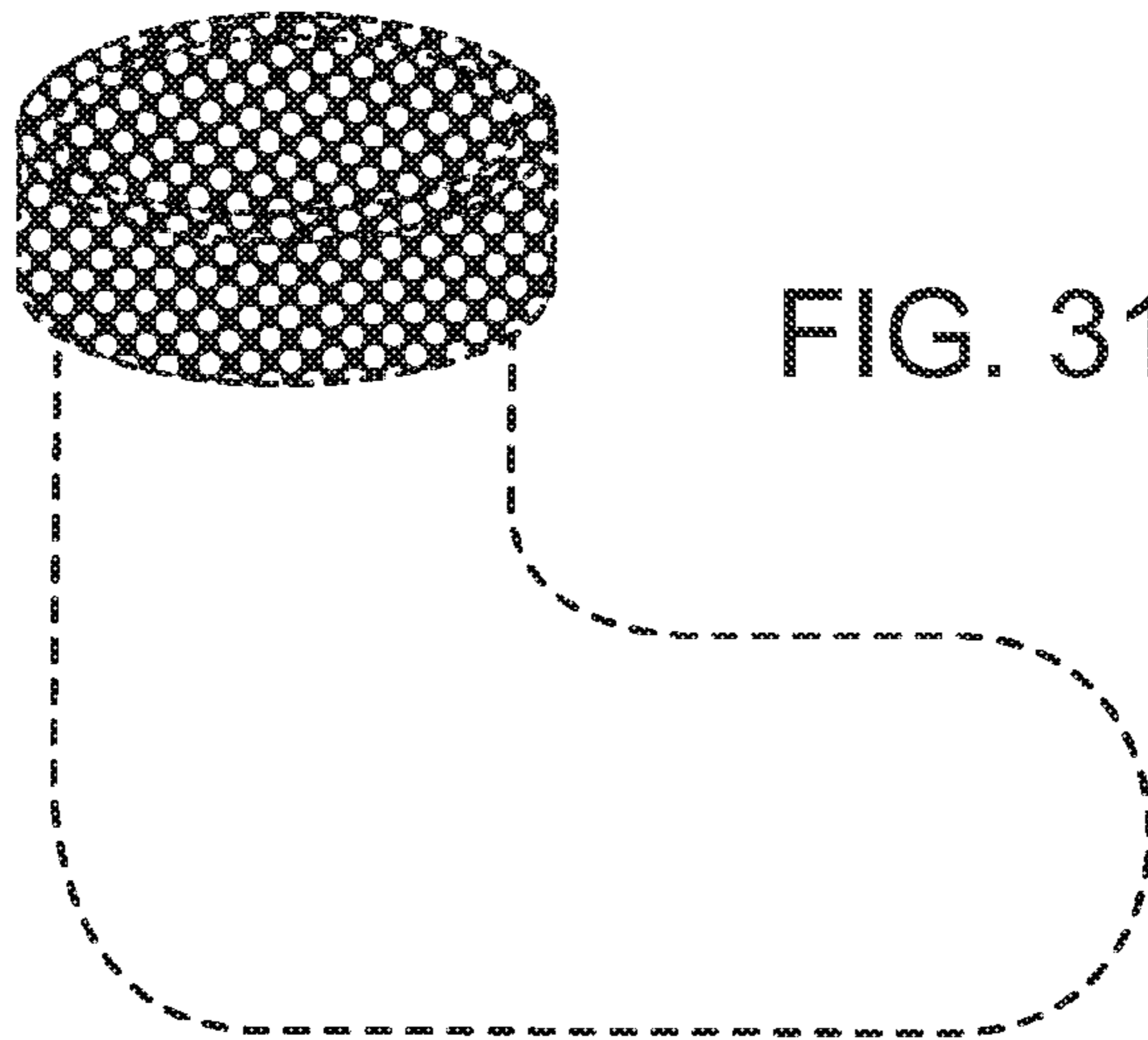

FIG. 31

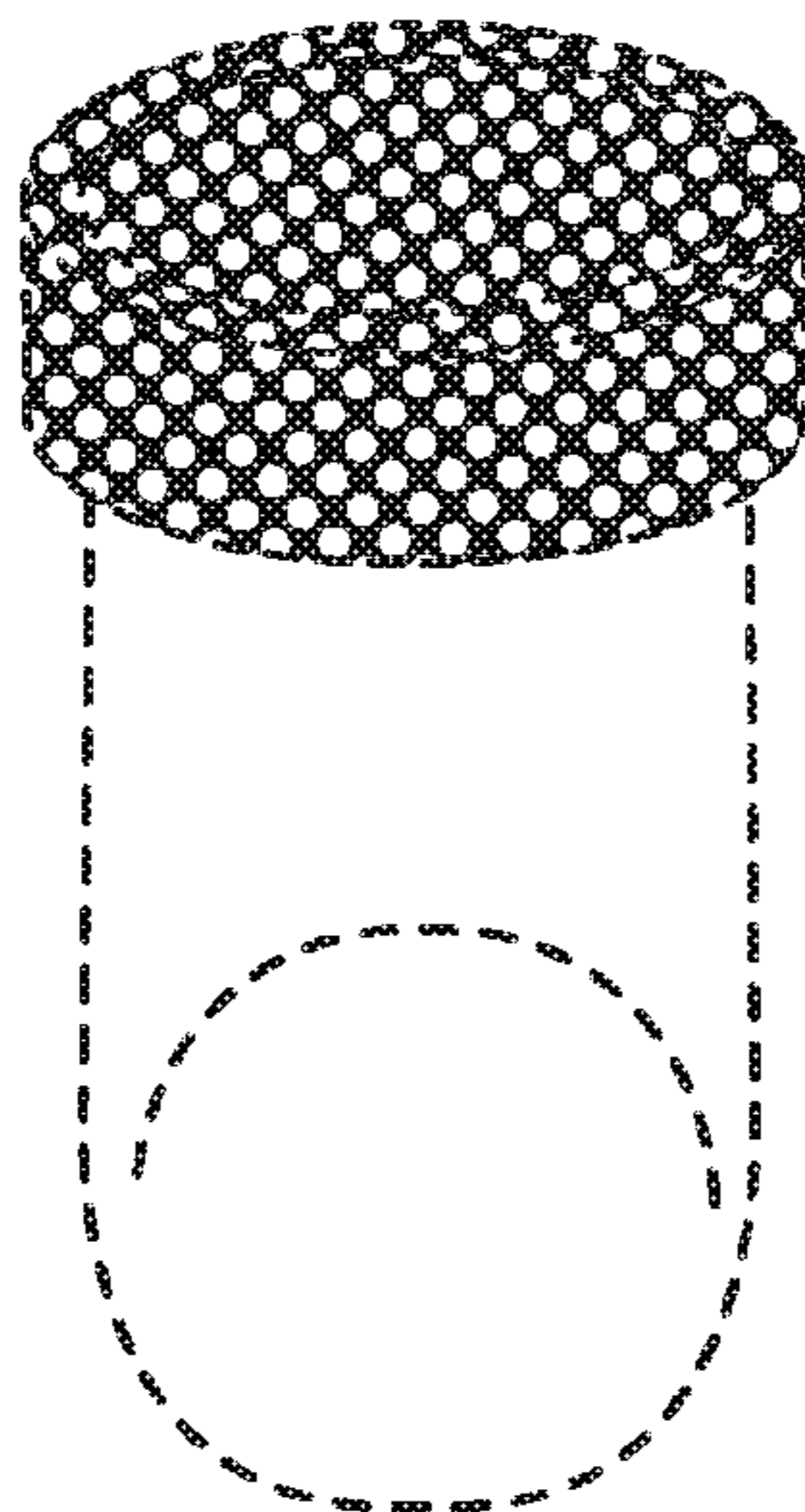

FIG. 32

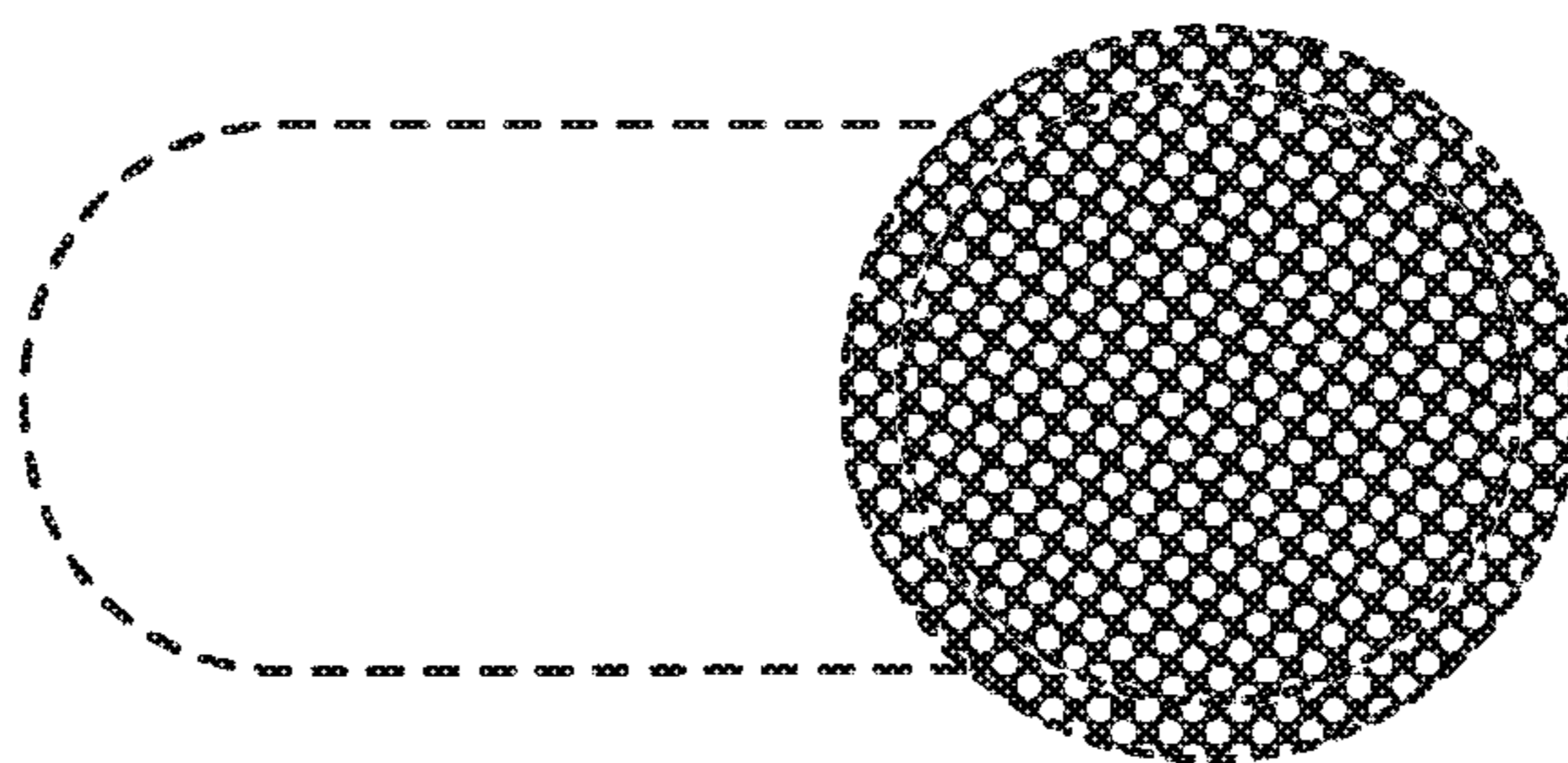

FIG. 33

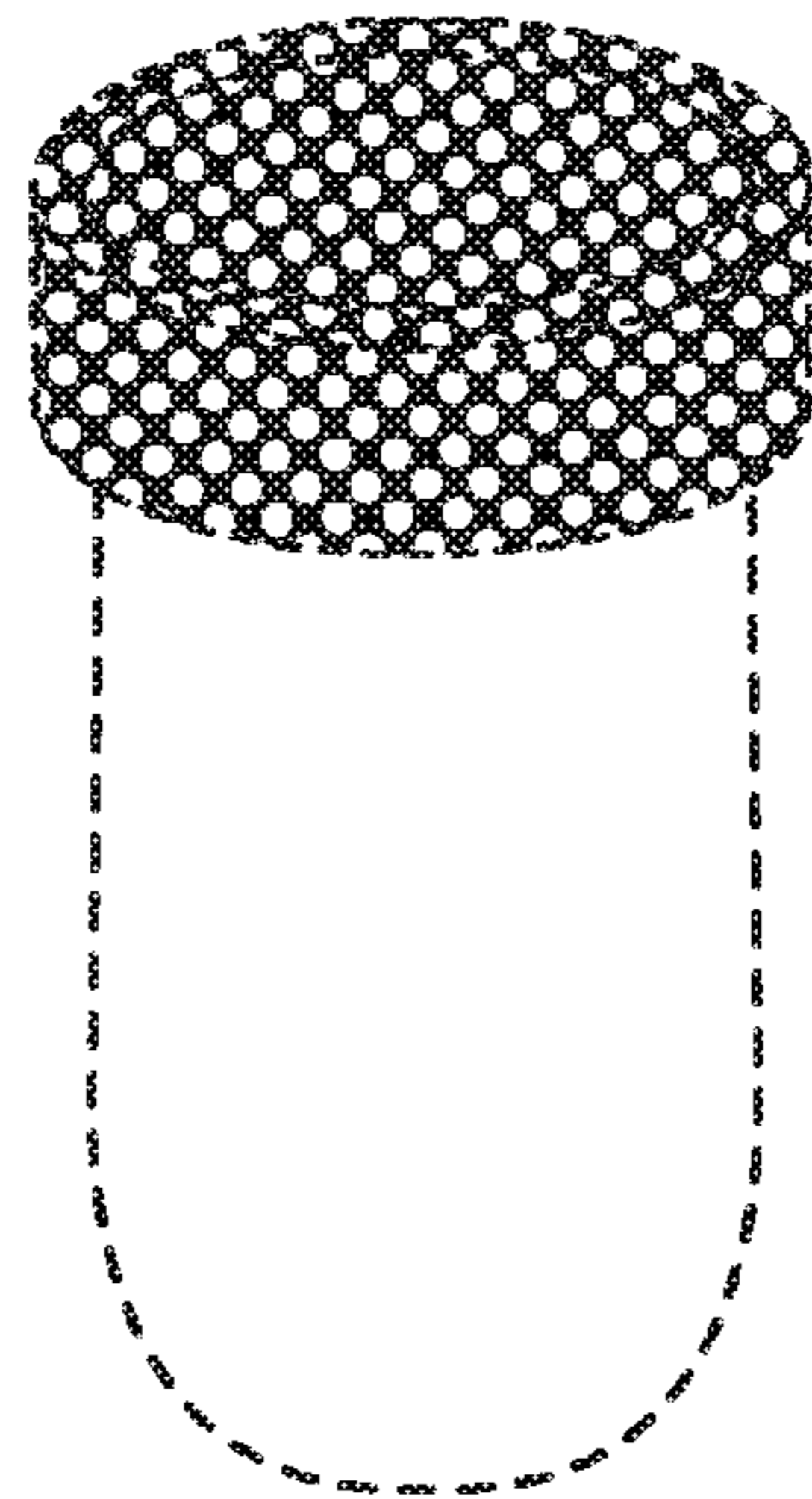
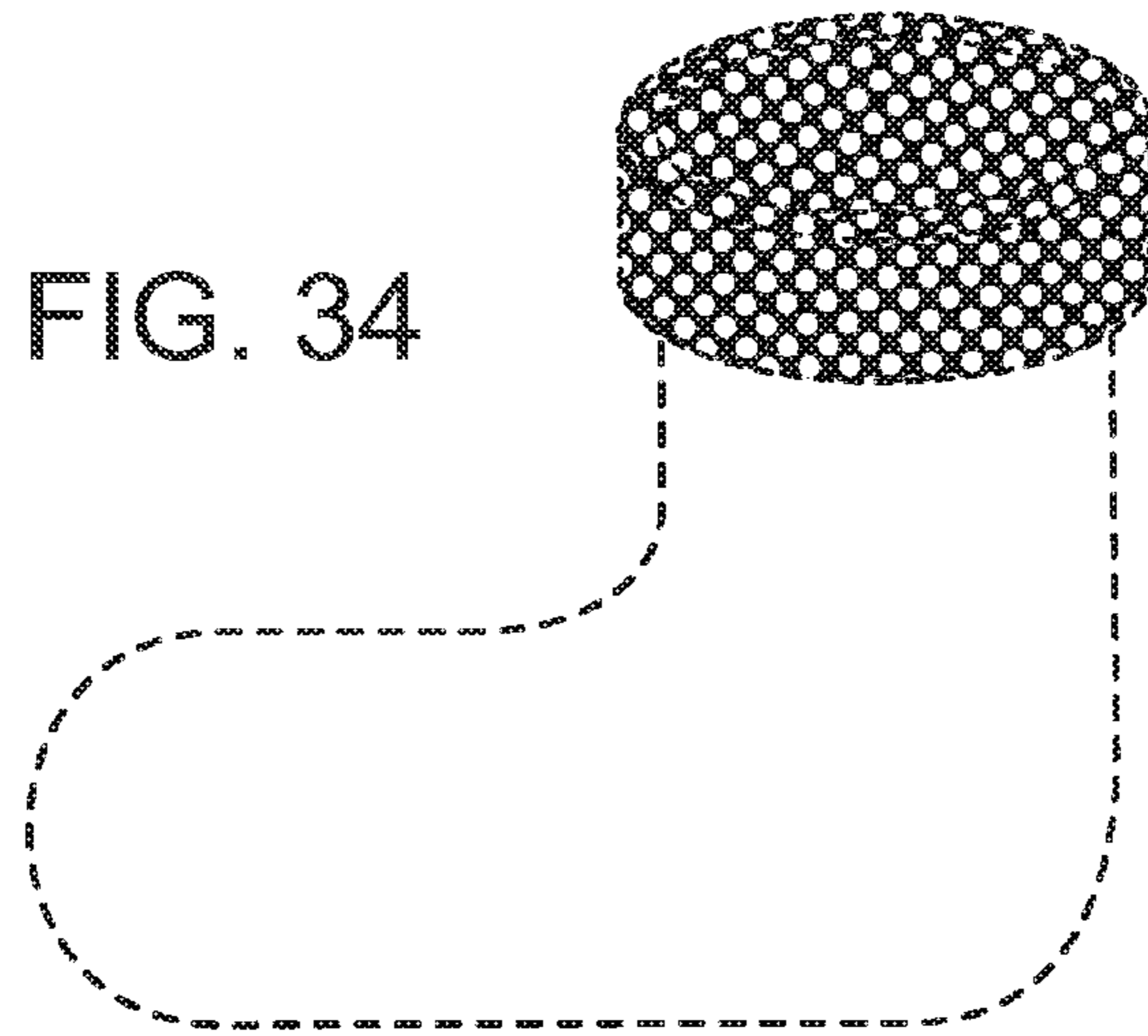

FIG. 35

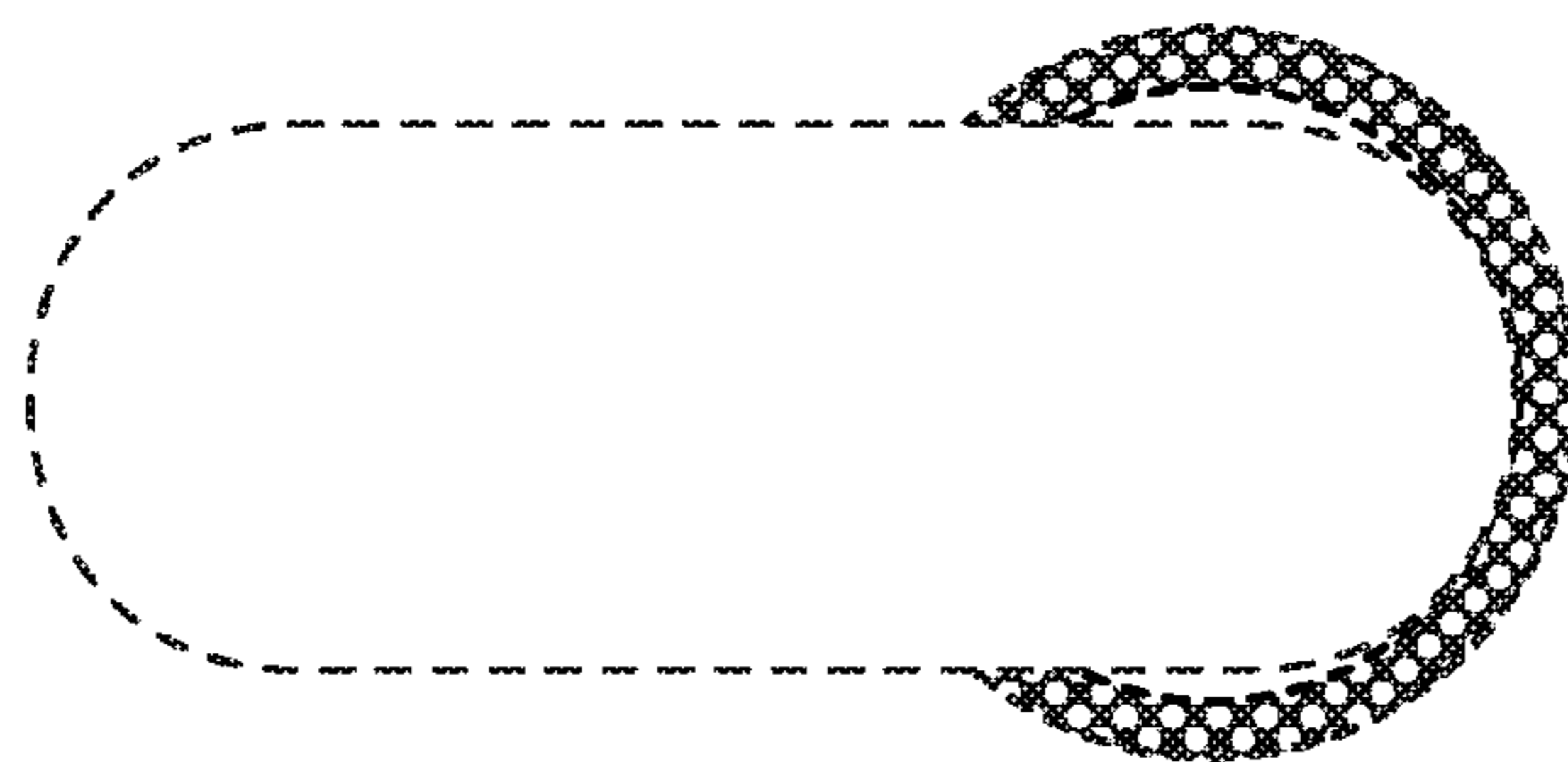

FIG. 36

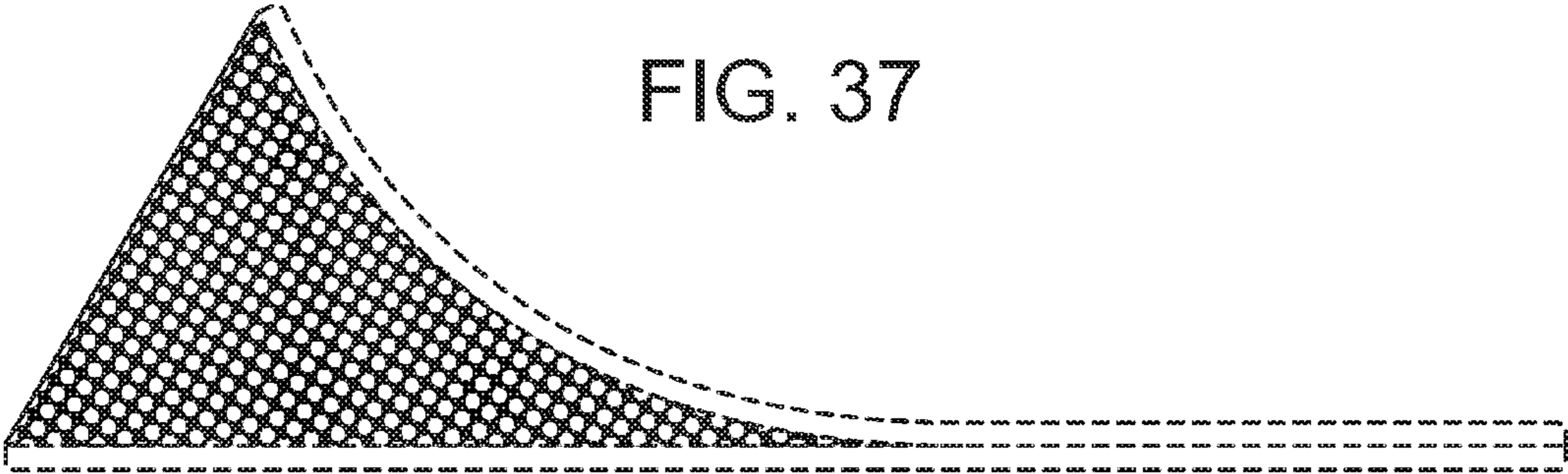

FIG. 37

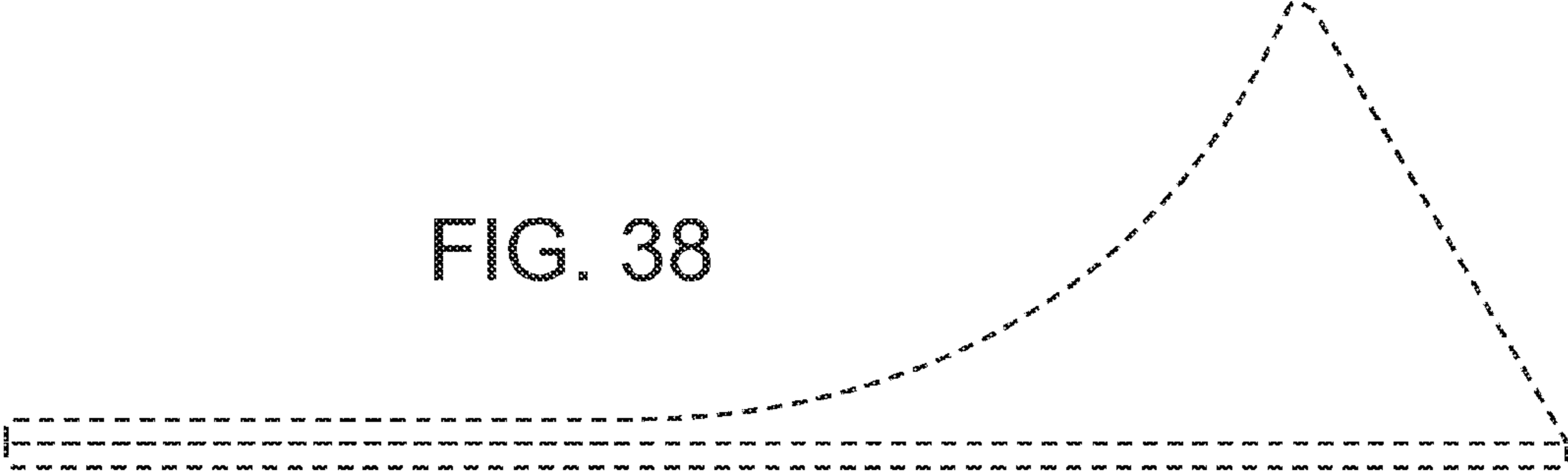

FIG. 38

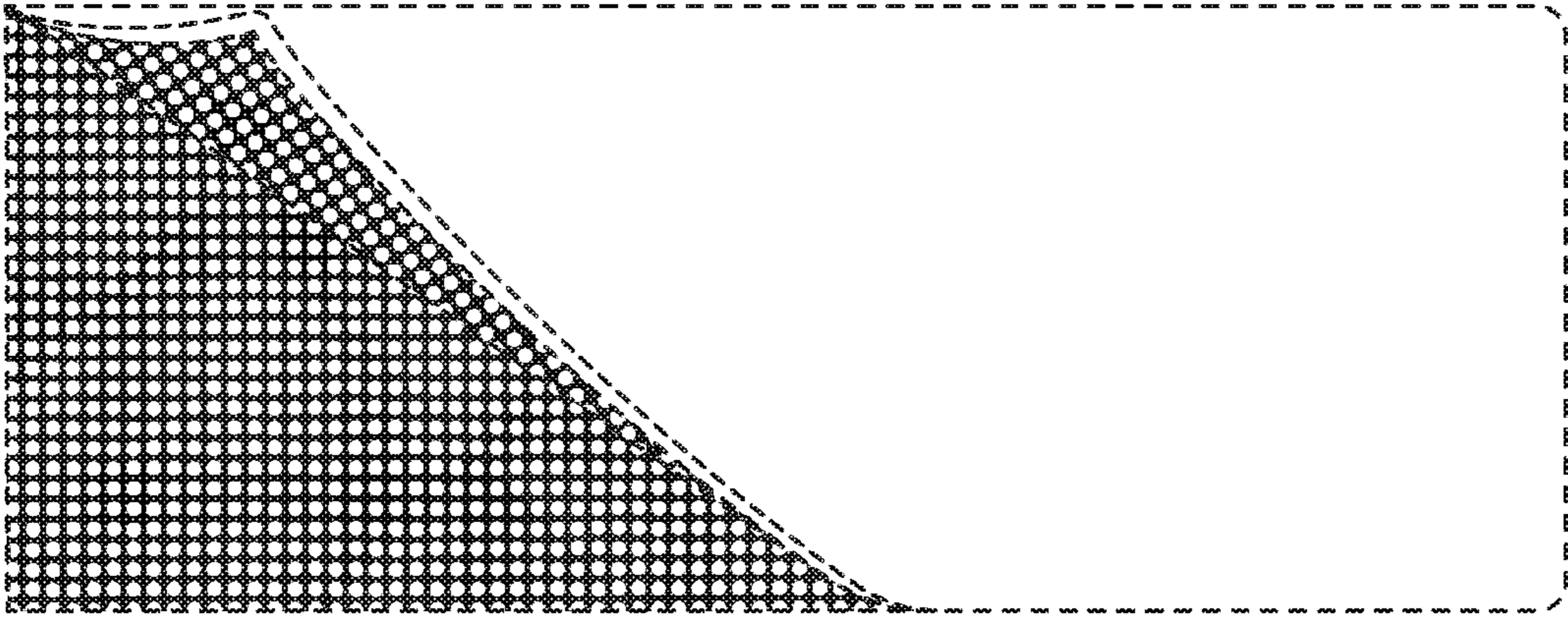

FIG. 39

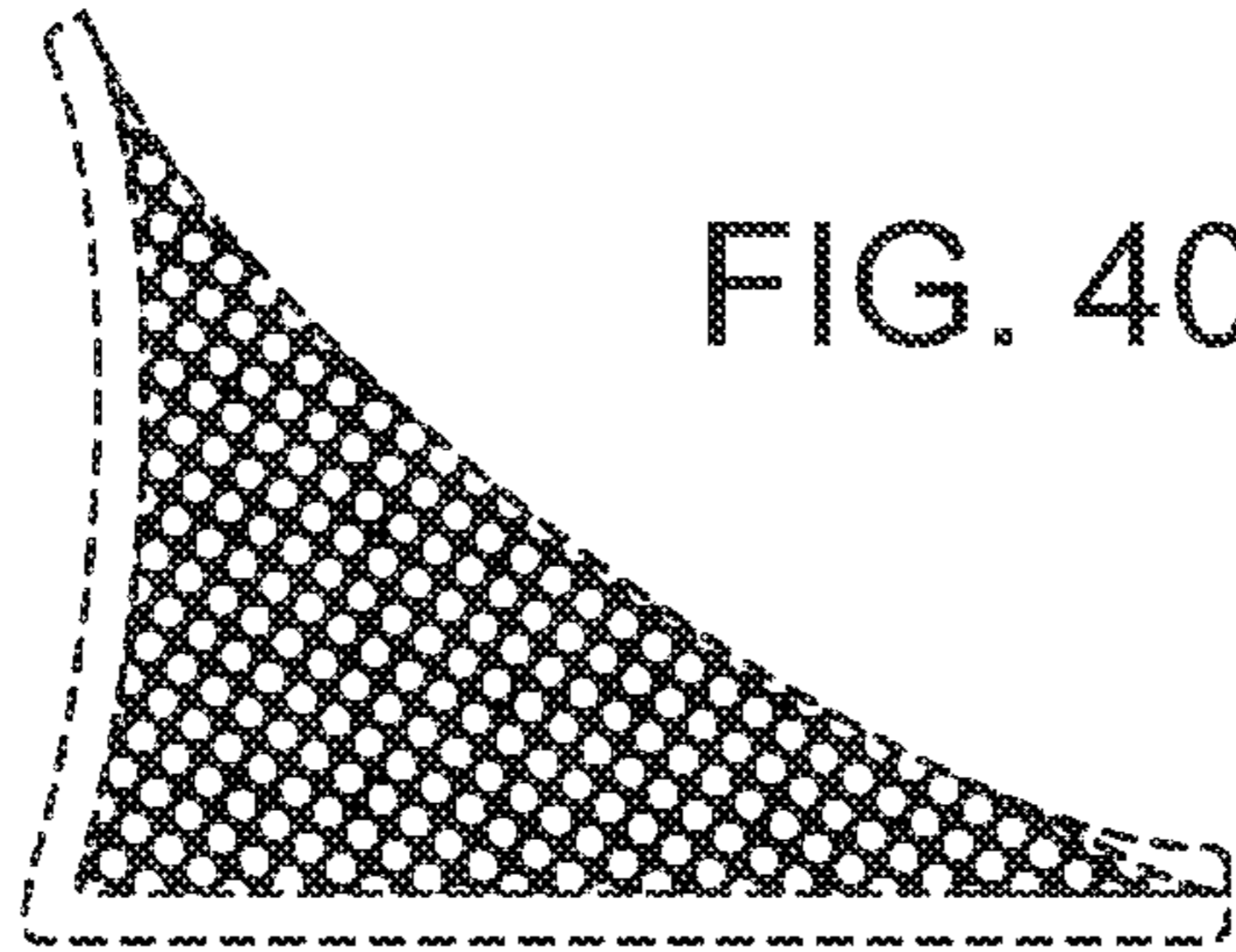

FIG. 40

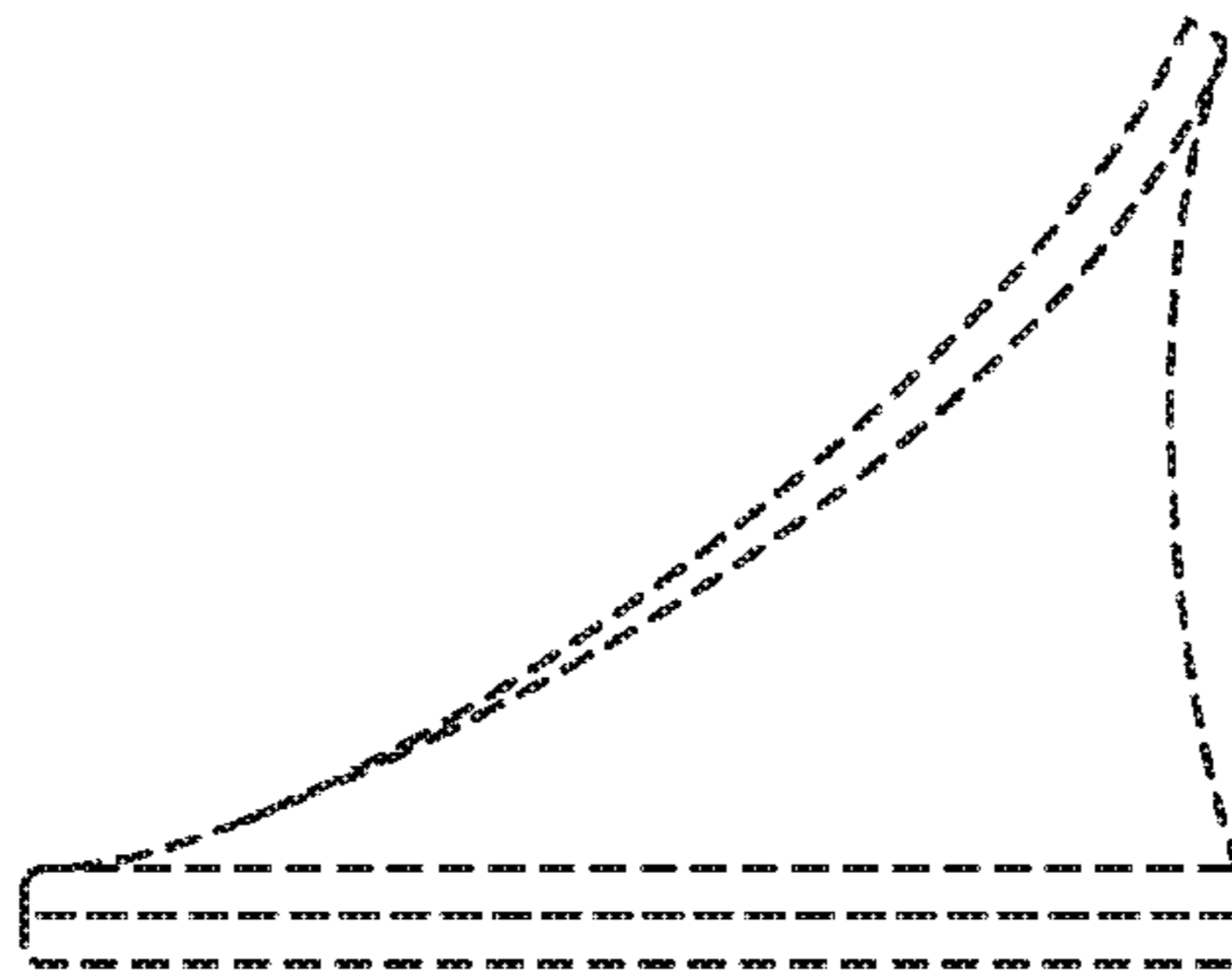

FIG. 41



FIG. 42

FIG. 43

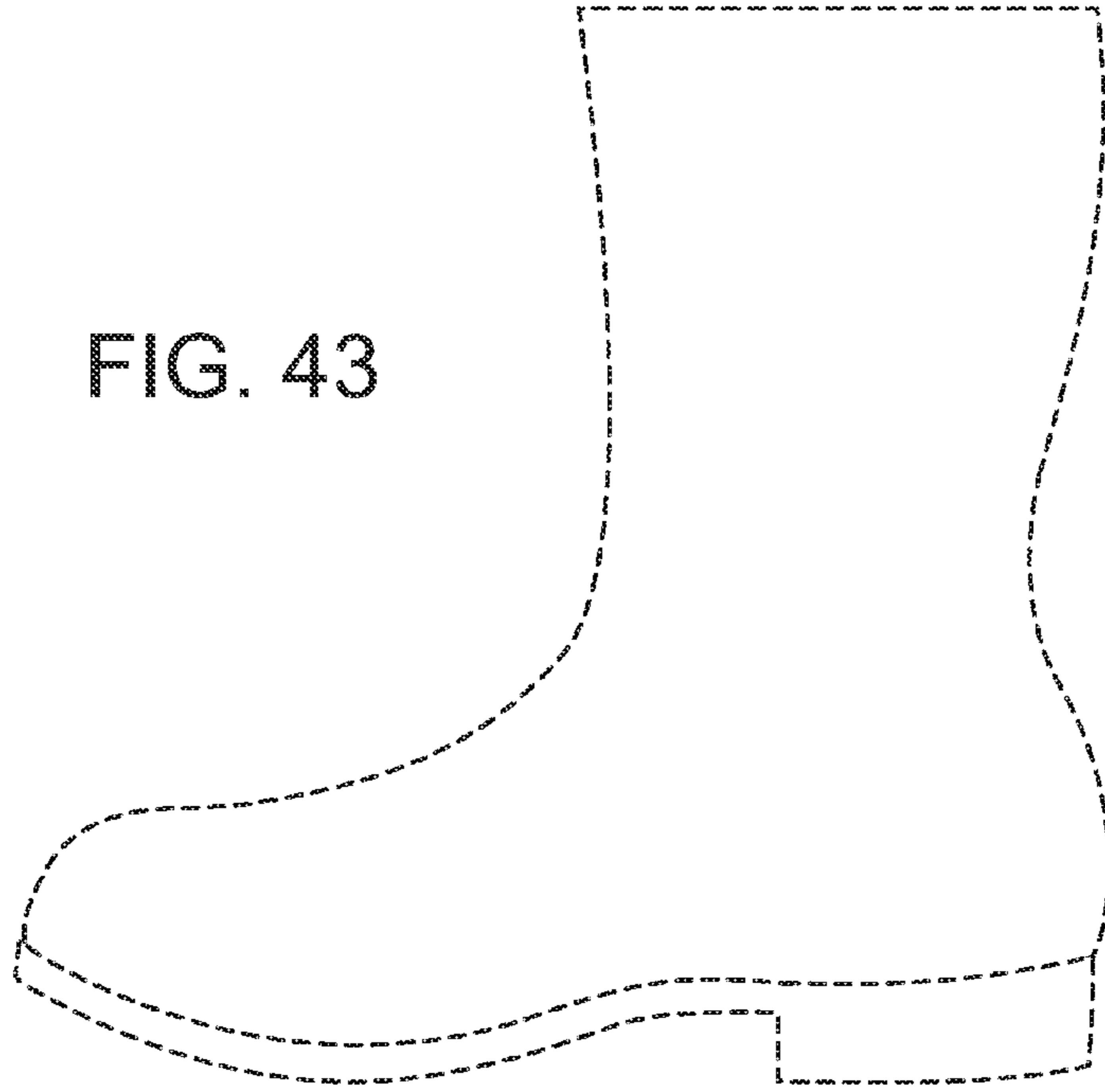

FIG. 44

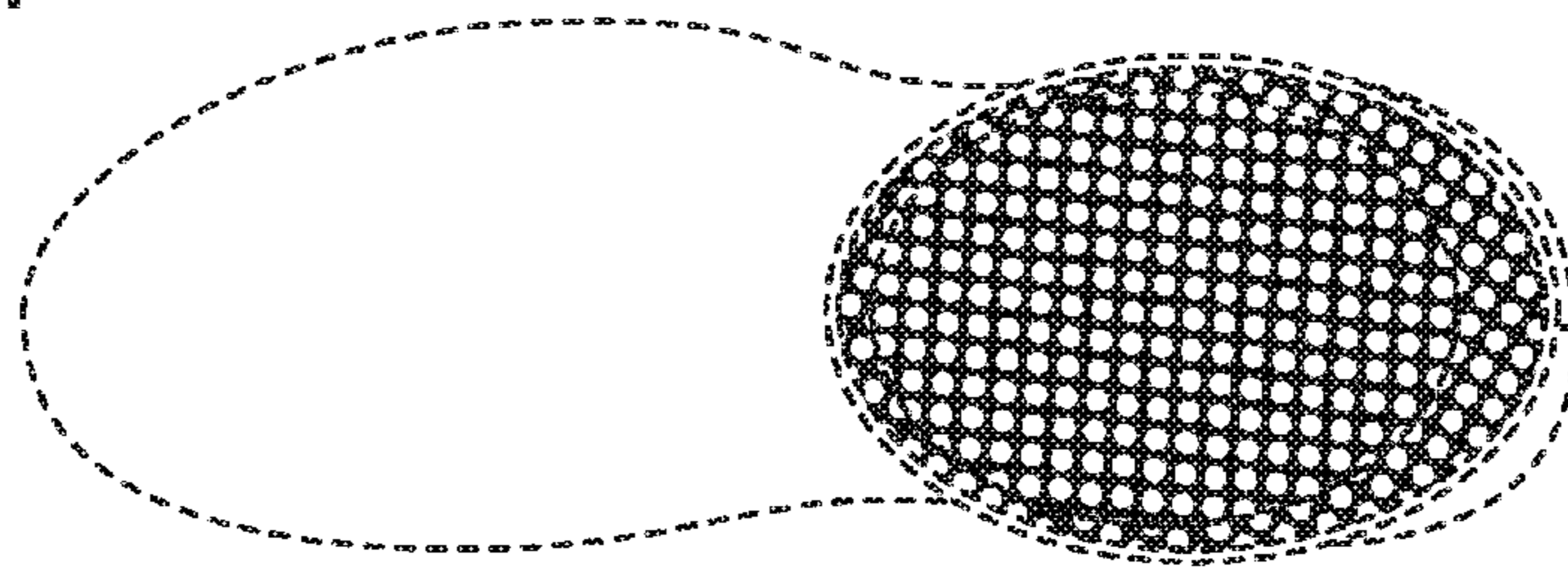
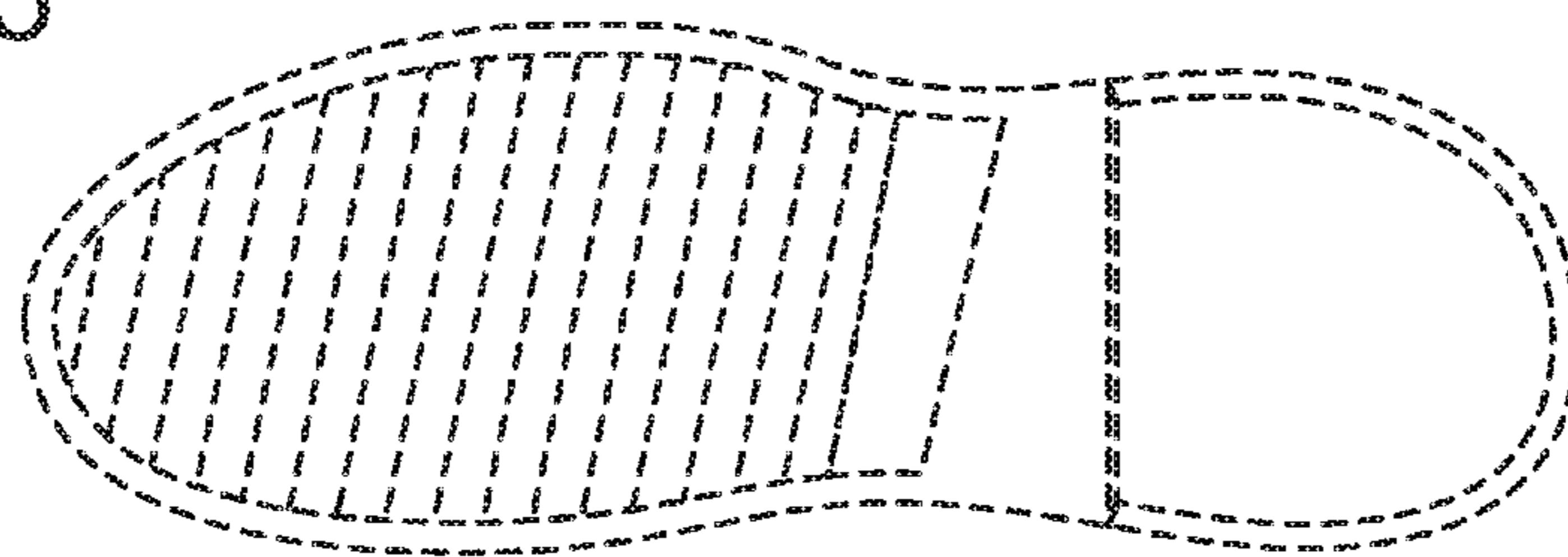

FIG. 45



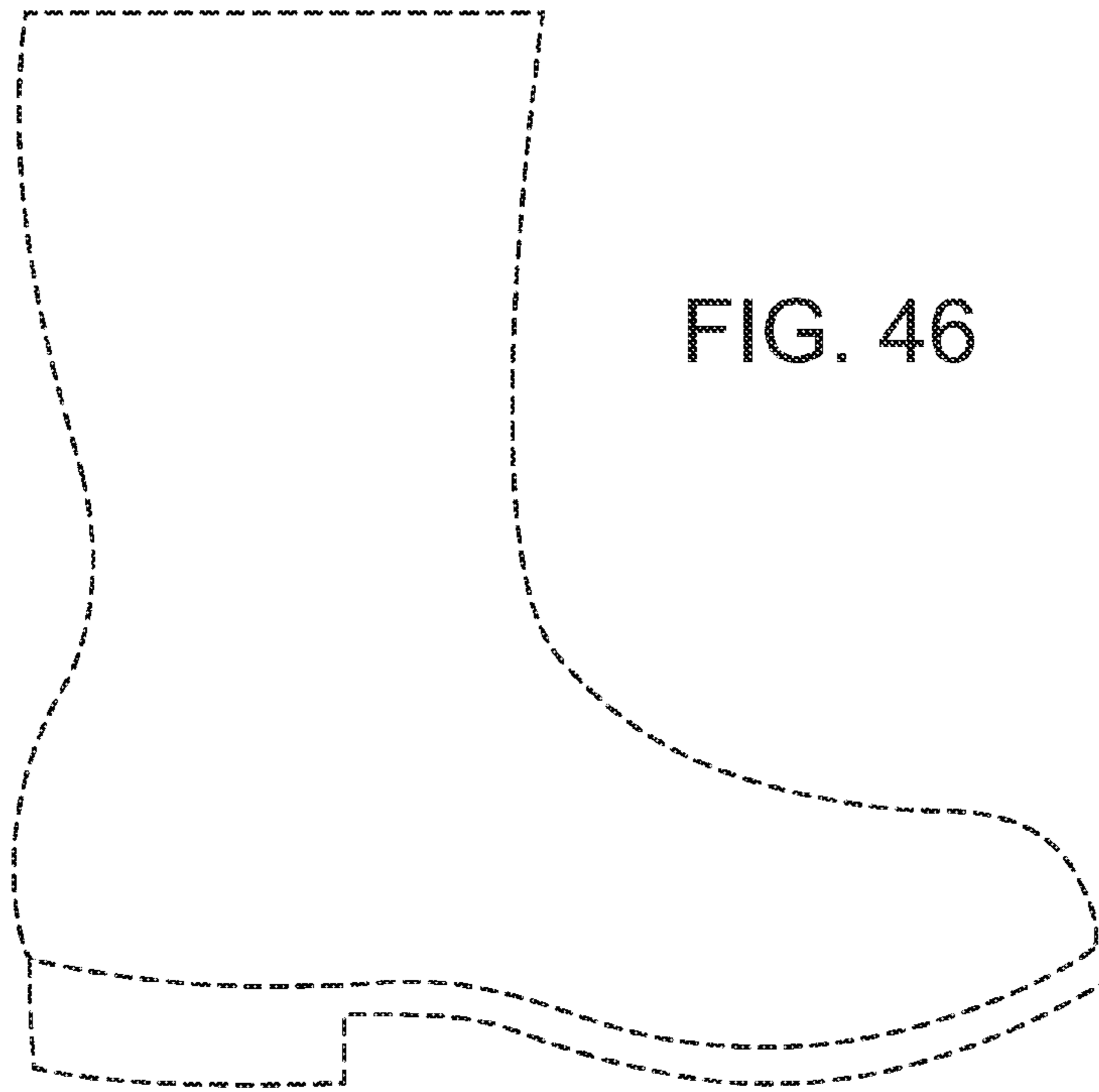

FIG. 46

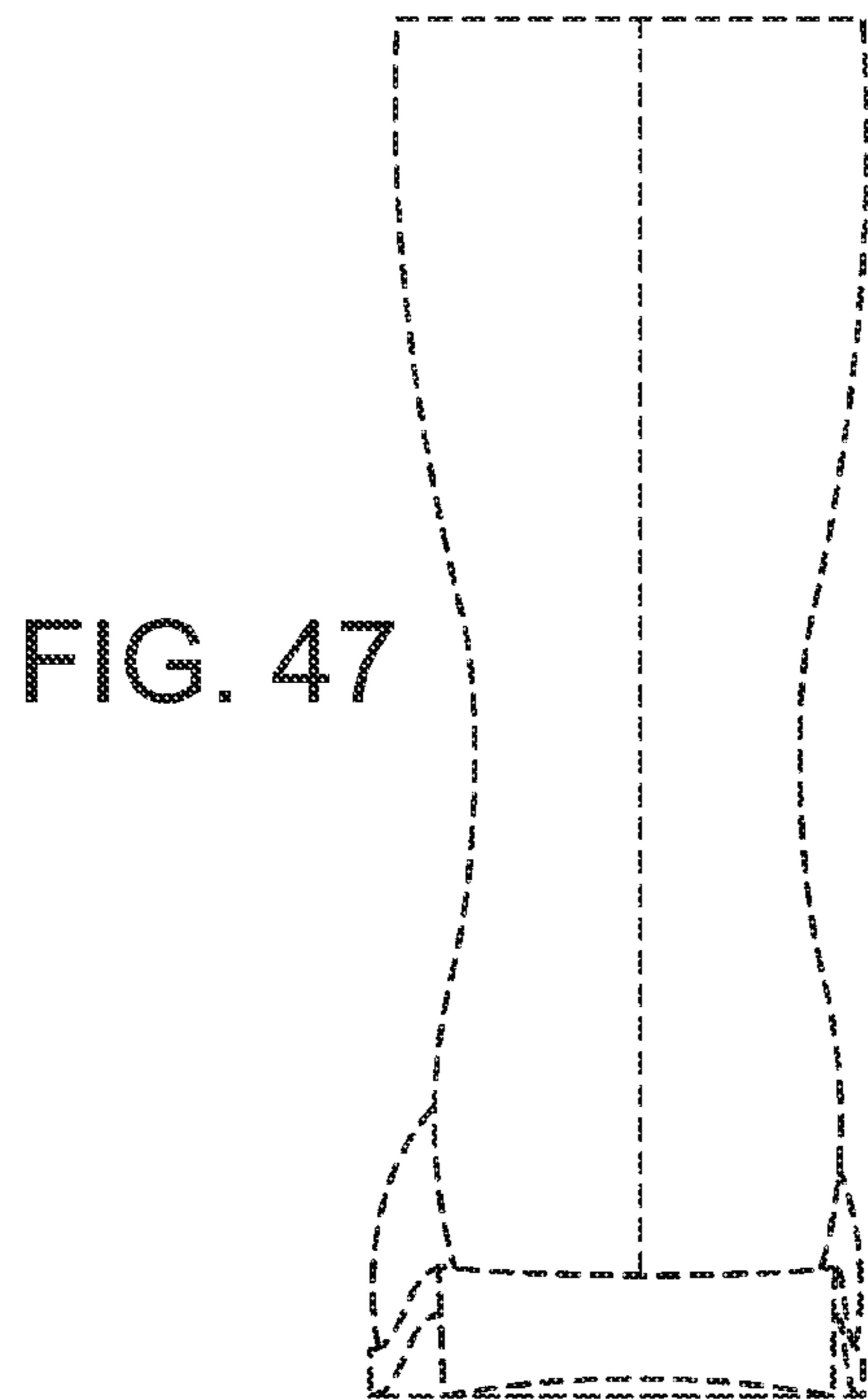

FIG. 47

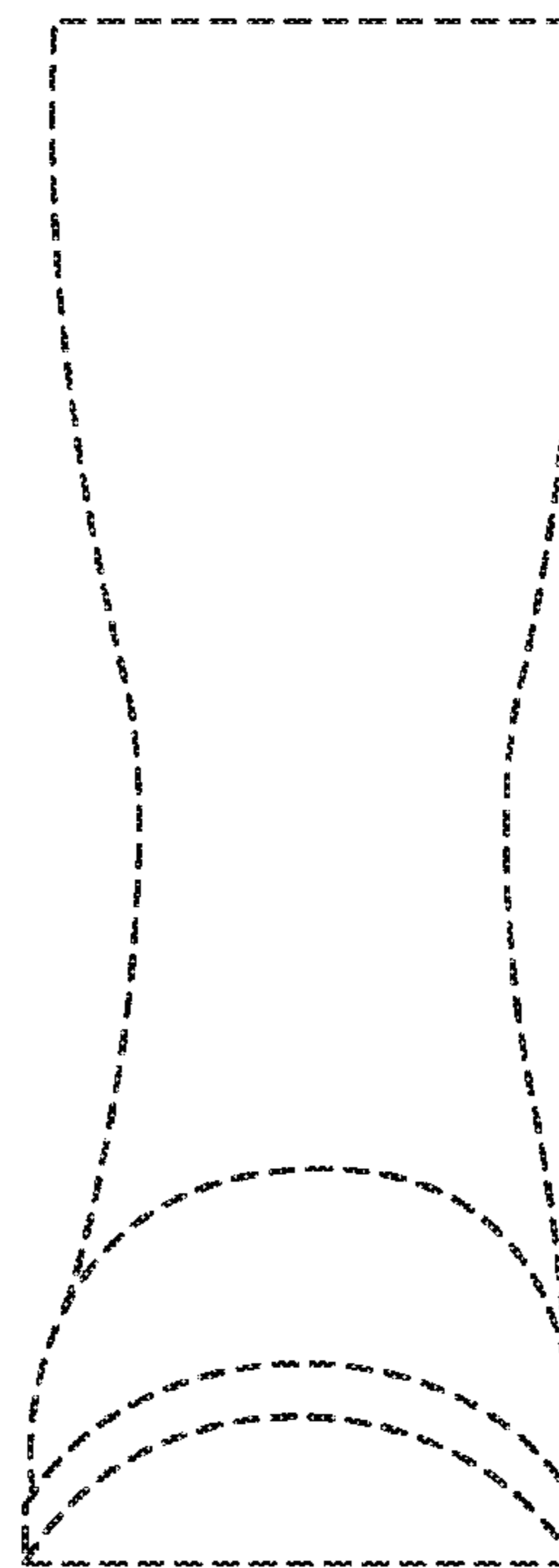

FIG. 48