



US00D670367S

(12) **United States Design Patent**  
**Miller et al.**

(10) **Patent No.:** **US D670,367 S**  
(45) **Date of Patent:** **\*\* Nov. 6, 2012**

(54) **SINK**

(75) Inventors: **Jason Miller**, Sheboygan Falls, WI (US); **Terrence K. Mahon**, Whitefish Bay, WI (US); **Shawn J. Booth**, Sheboygan, WI (US); **Peter Tabeling**, Lakewood, OH (US)

(73) Assignee: **Kohler Co.**, Kohler, WI (US)

(\*\*) Term: **14 Years**

(21) Appl. No.: **29/425,479**

(22) Filed: **Jun. 22, 2012**

**Related U.S. Application Data**

(62) Division of application No. 29/412,242, filed on Feb. 1, 2012, now Pat. No. Des. 663,389, which is a division of application No. 29/386,884, filed on Mar. 4, 2011, now Pat. No. Des. 655,798.

(51) **LOC (9) Cl.** ..... **23-02**  
(52) **U.S. Cl.** ..... **D23/308**  
(58) **Field of Classification Search** ..... D23/284,  
D23/290–292, 293.1, 303, 308; 4/619, 639–640  
See application file for complete search history.

(56) **References Cited**

**U.S. PATENT DOCUMENTS**

D353,652	S	*	12/1994	Dannenber	.....	D23/293.1
D484,956	S	*	1/2004	Rachiele	.....	D23/293.1
D492,983	S	*	7/2004	Rachiele	.....	D23/293.1
D498,291	S	*	11/2004	Bayer	.....	D23/290
D508,984	S	*	8/2005	Gordon	.....	D23/293.1
D527,808	S	*	9/2006	Wozniczka et al.	.....	D23/290
D546,929	S	*	7/2007	Schneider et al.	.....	D23/290
D585,126	S	*	1/2009	Eilmus et al.	.....	D23/290
D603,486	S	*	11/2009	Mayer et al.	.....	D23/293.1

**OTHER PUBLICATIONS**

Rachiele; "Patented copper apron front sink with channel;" [http://www.rachiele.com/copper\\_apron\\_sinks-with-patent.asp](http://www.rachiele.com/copper_apron_sinks-with-patent.asp); retrieval date: Nov. 30, 2011; 3 pages.

\* cited by examiner

*Primary Examiner* — Robert Delehanty

(74) *Attorney, Agent, or Firm* — Foley & Lardner LLP

(57) **CLAIM**

We claim the ornamental design for a sink, as shown and described.

**DESCRIPTION**

FIG. 1 is a top perspective view of an embodiment of the claimed design;  
FIG. 2 is a top plan view of the claimed design of FIG. 1;  
FIG. 3 is a bottom plan view of the claimed design of FIG. 1;  
FIG. 4 is a front elevation view of the claimed design of FIG. 1;  
FIG. 5 is a right-side elevation view of the claimed design of FIG. 1;  
FIG. 6 is a rear elevation view of the claimed design of FIG. 1;  
FIG. 7 is a cross-sectional view of FIG. 2;  
FIG. 8 is another cross-sectional view of FIG. 2;  
FIG. 9 is another cross-sectional view of FIG. 2; and,  
FIG. 10 is a detailed bottom perspective view of the claimed design of FIG. 1 showing a left end of a front apron.  
The ornamental design which is claimed is shown in solid lines in the drawings. The broken lines in the drawings are for illustrative purposes only and form no part of the claimed design.

**1 Claim, 6 Drawing Sheets**

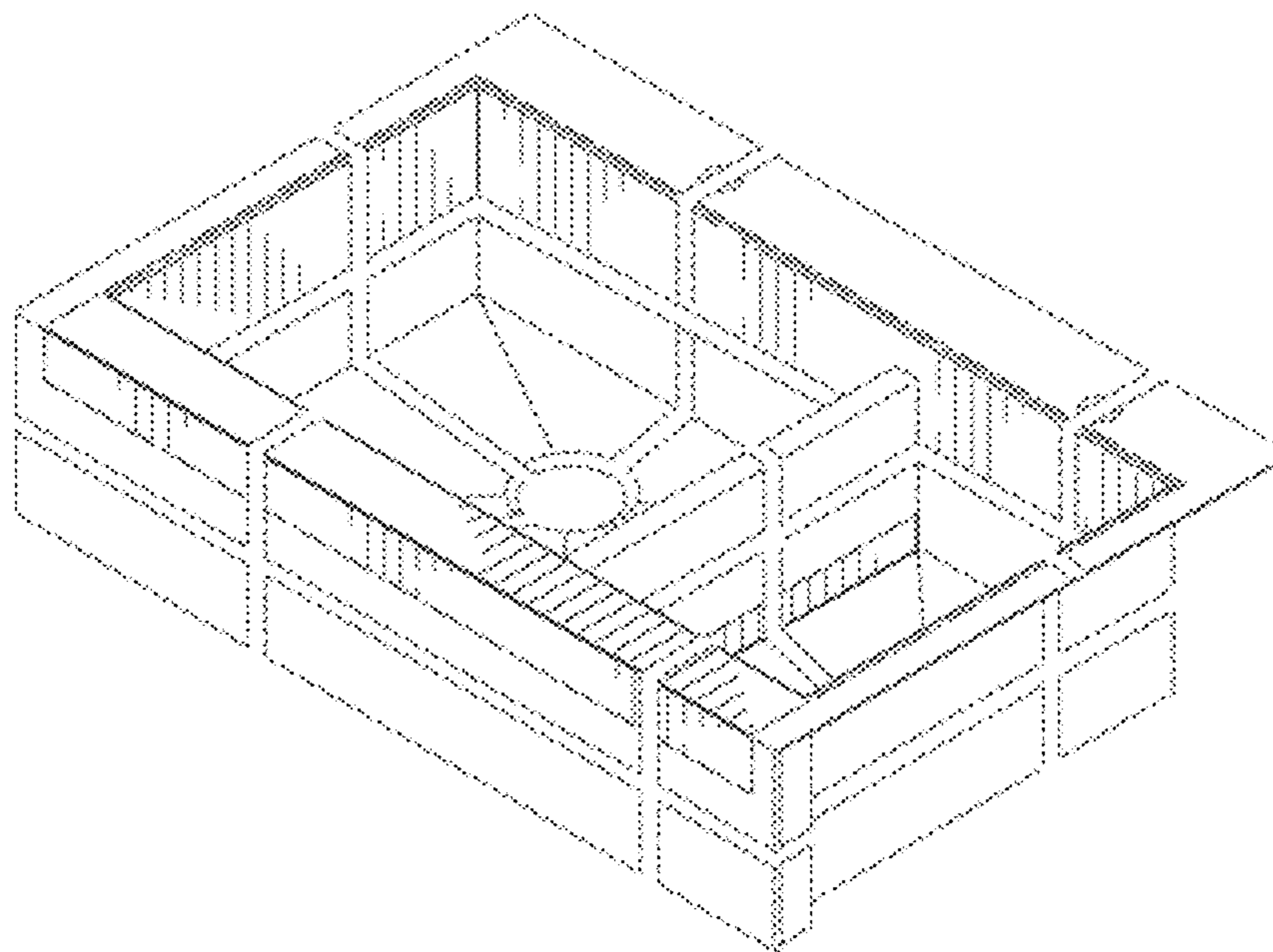

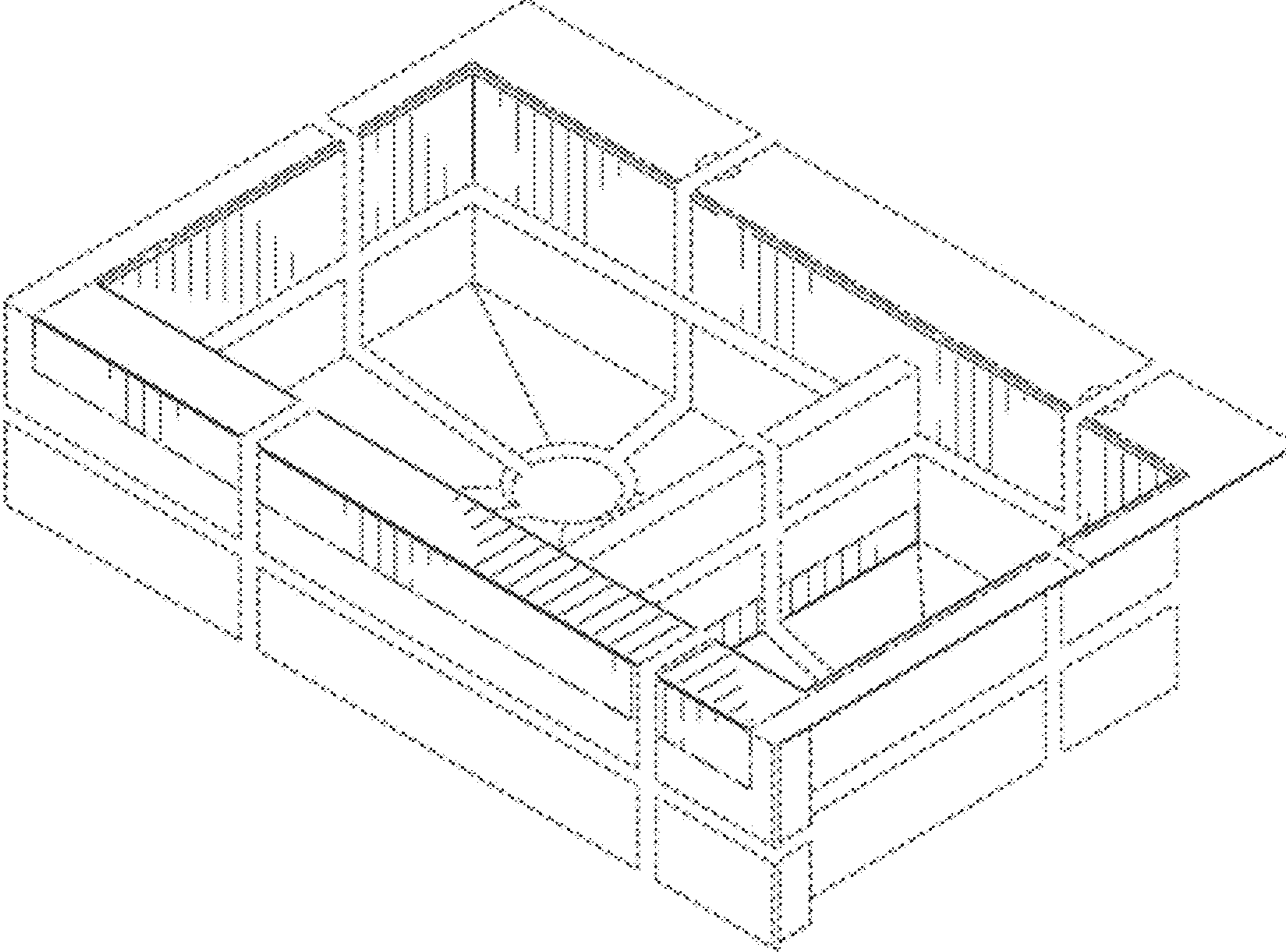

FIG. 1

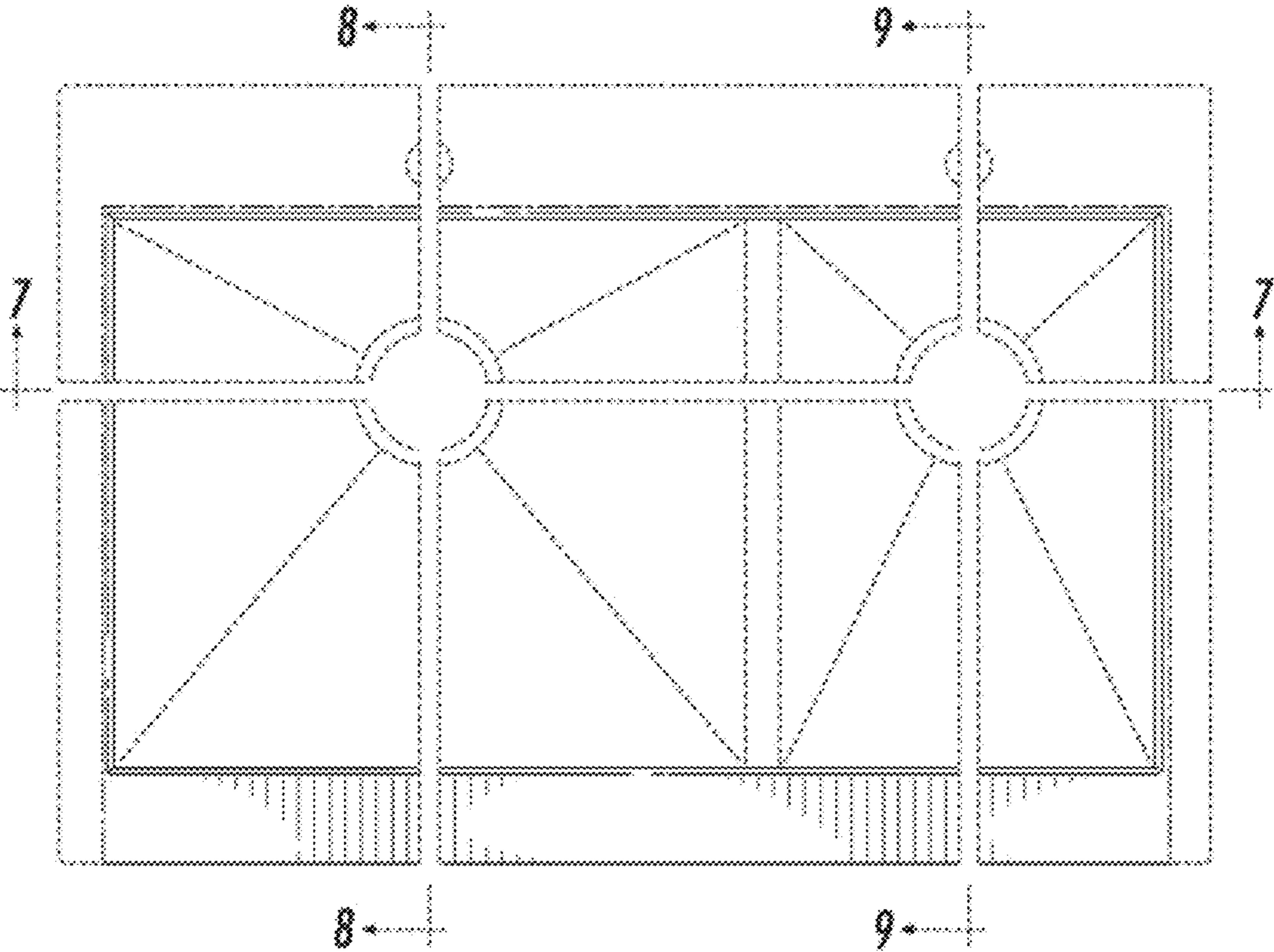

FIG. 2

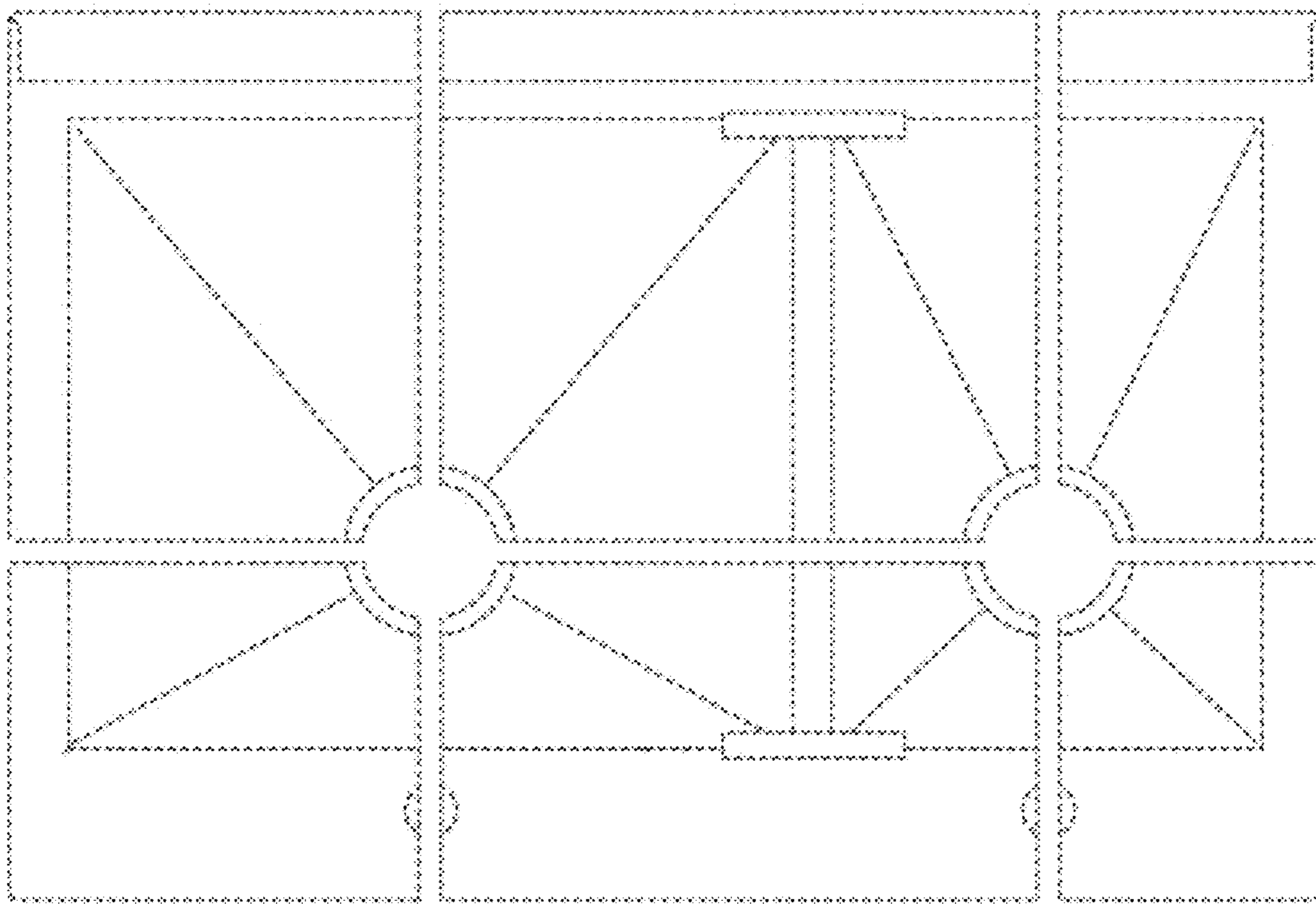

FIG. 3

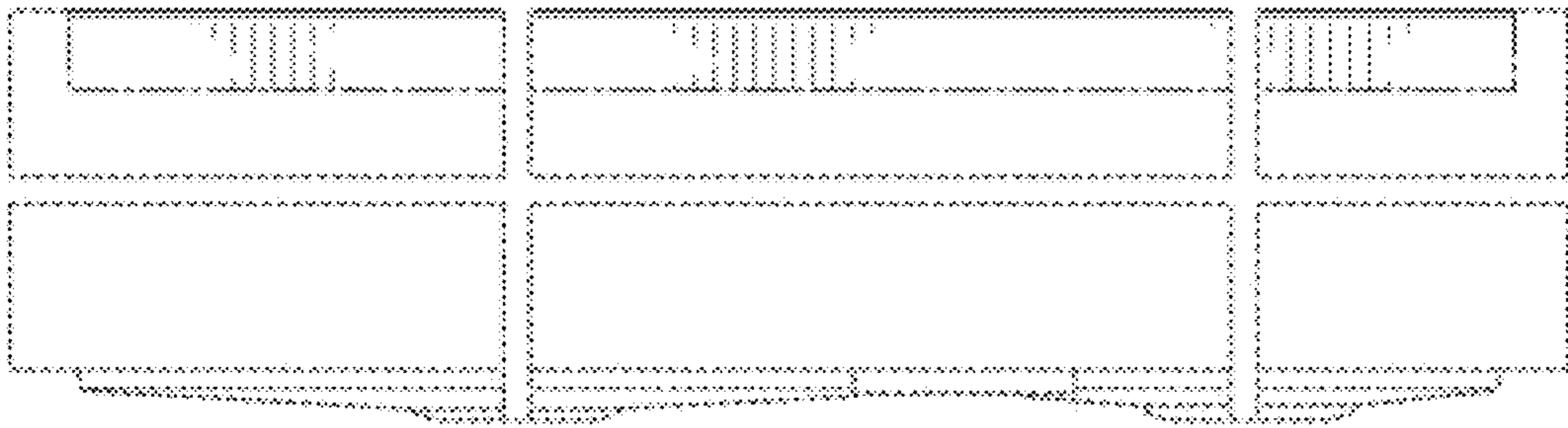

FIG. 4



FIG. 5

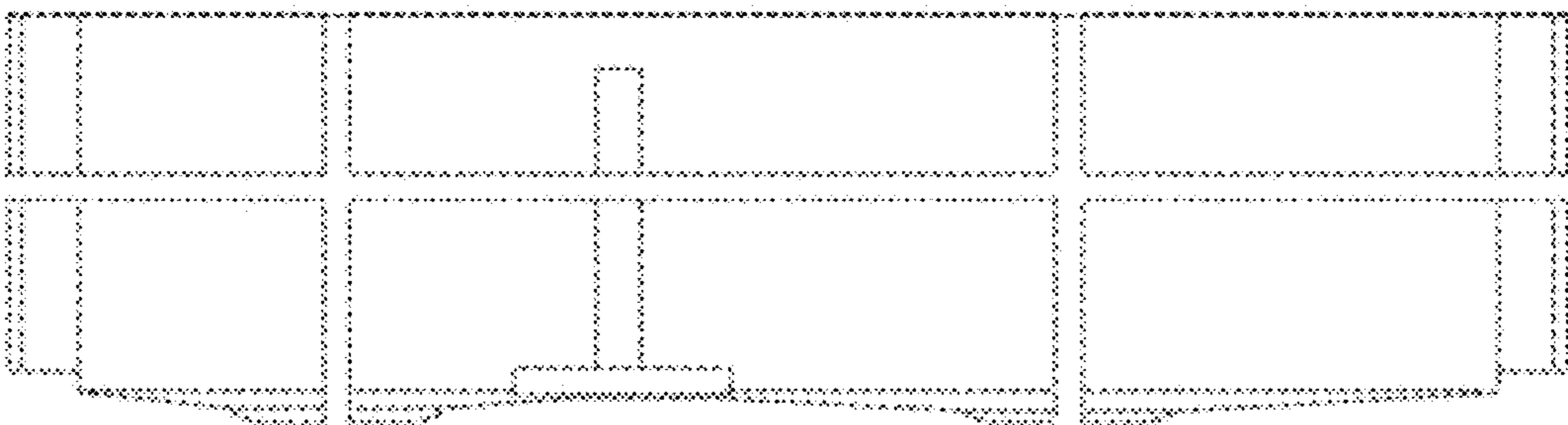

FIG. 6

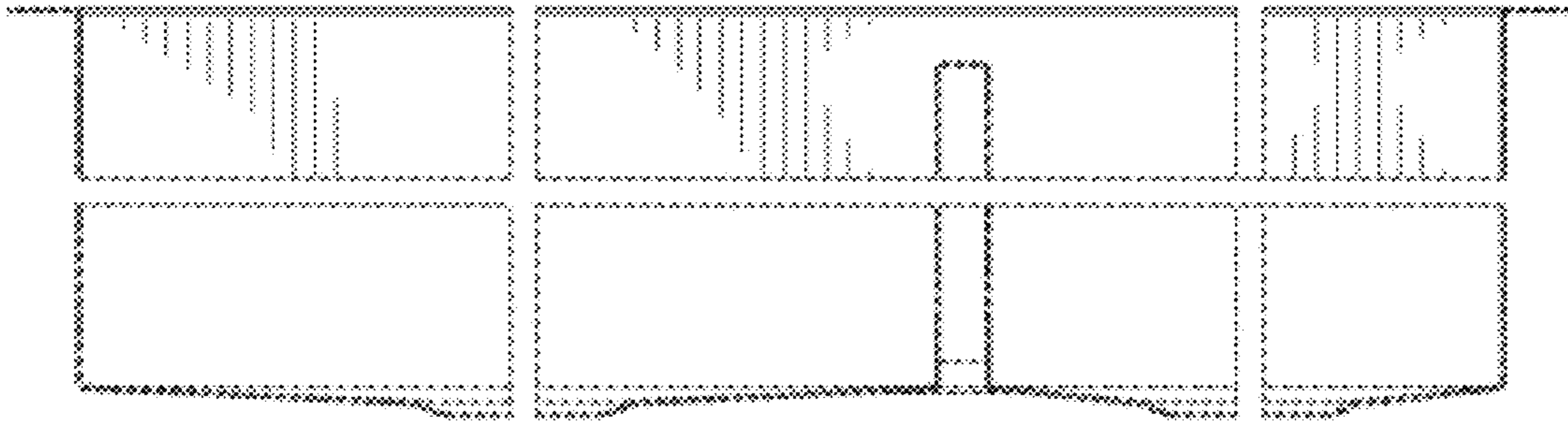

FIG. 7

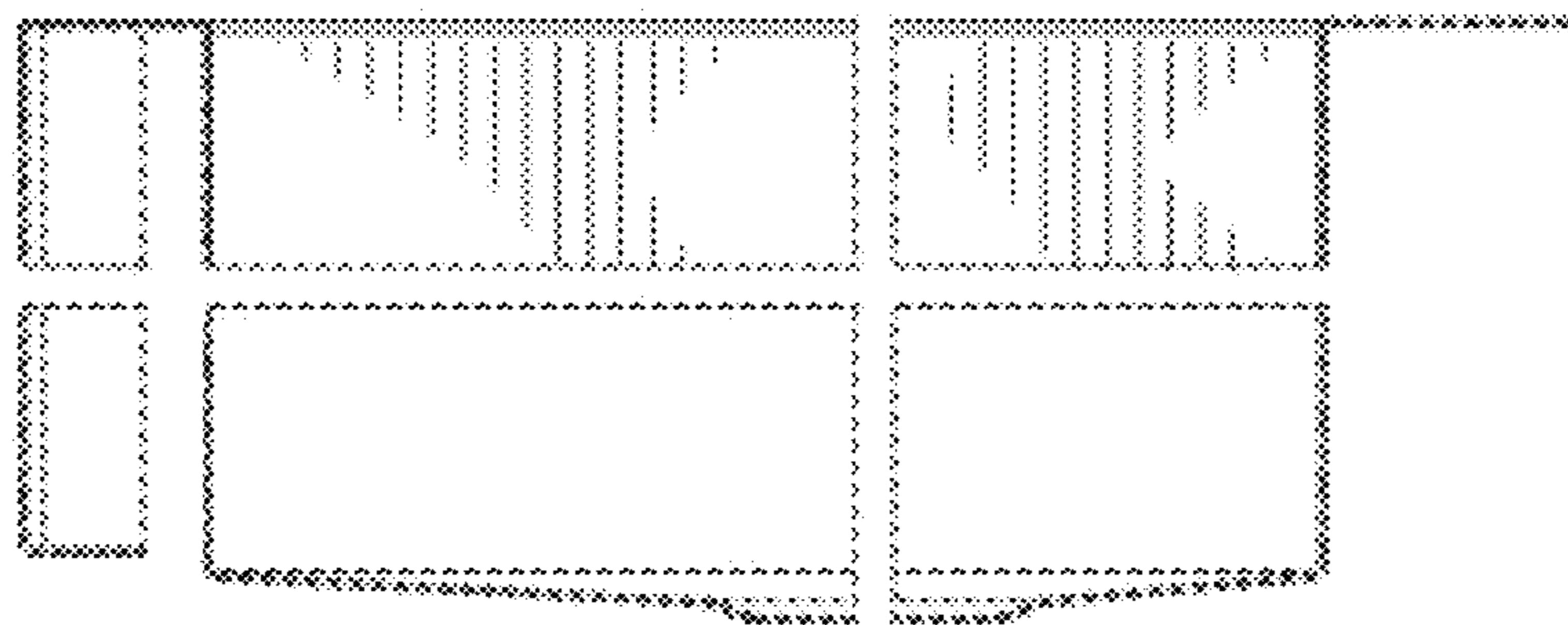

FIG. 8

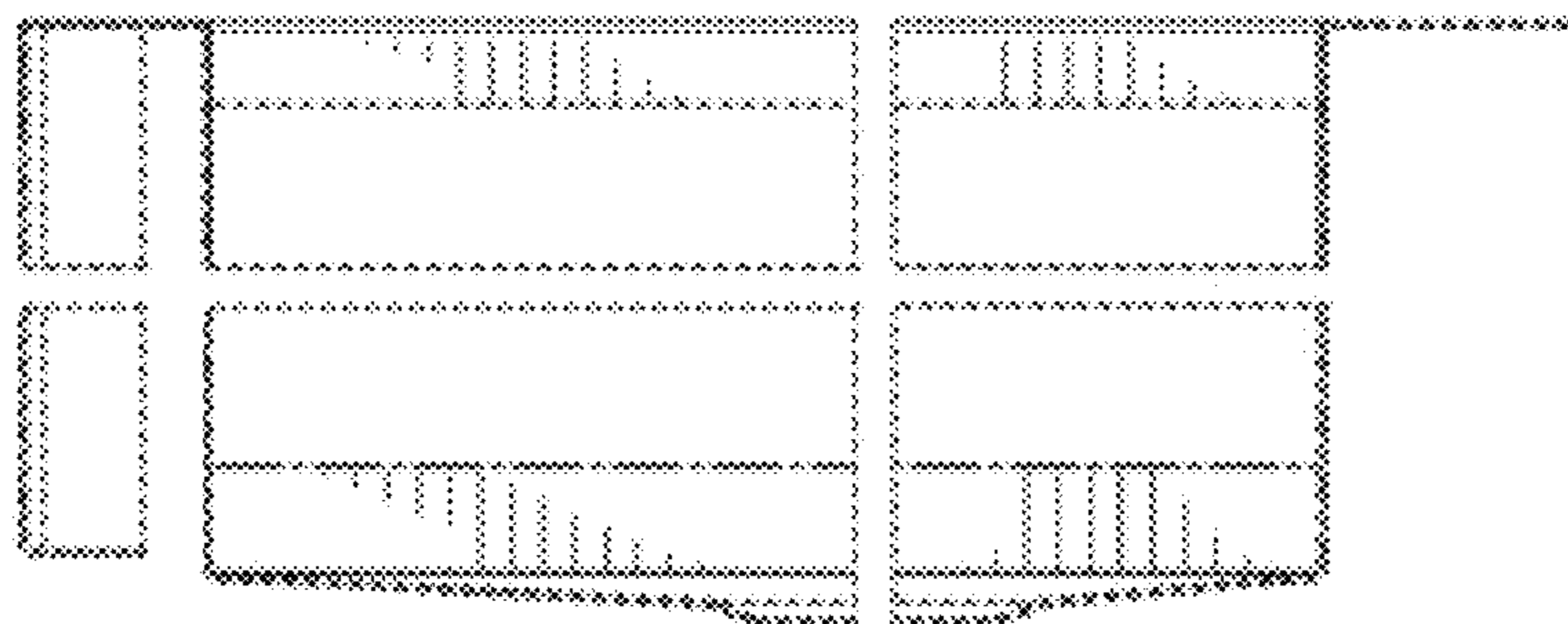

FIG. 9

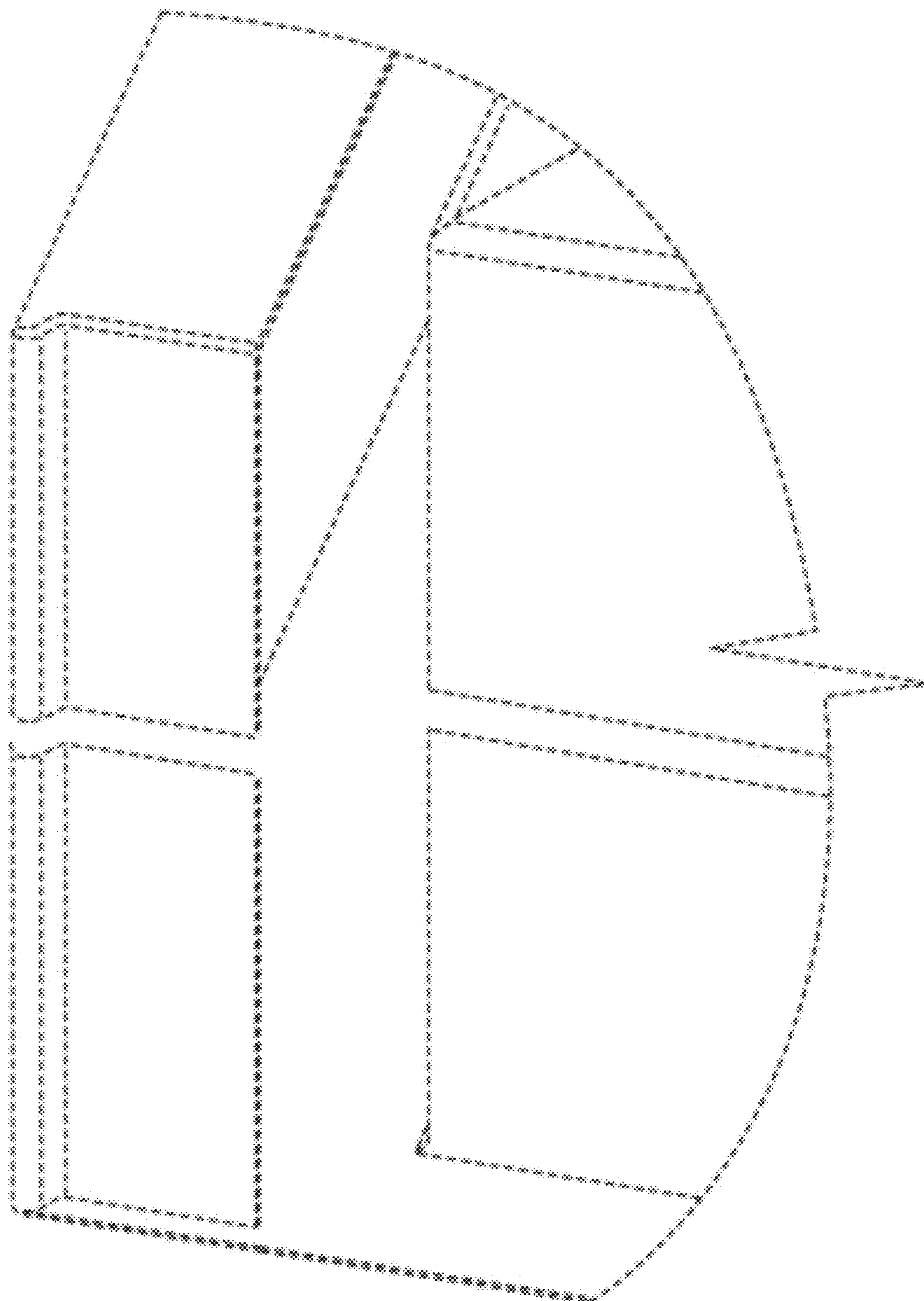

FIG. 10

UNITED STATES PATENT AND TRADEMARK OFFICE  
**CERTIFICATE OF CORRECTION**

PATENT NO. : D670,367 S  
APPLICATION NO. : 29/425479  
DATED : November 6, 2012  
INVENTOR(S) : Jason Miller et al.

Page 1 of 7

It is certified that error appears in the above-identified patent and that said Letters Patent is hereby corrected as shown below:

In the Drawings:

Replace Figs. 1-10 with the attached drawing sheets.

Signed and Sealed this  
Third Day of December, 2013

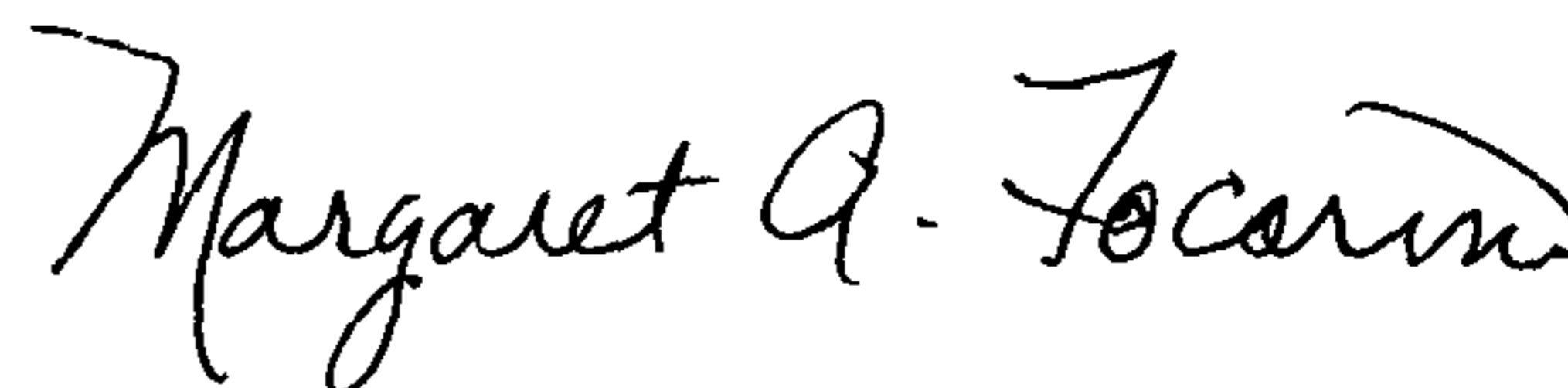

Margaret A. Focarino  
*Commissioner for Patents of the United States Patent and Trademark Office*



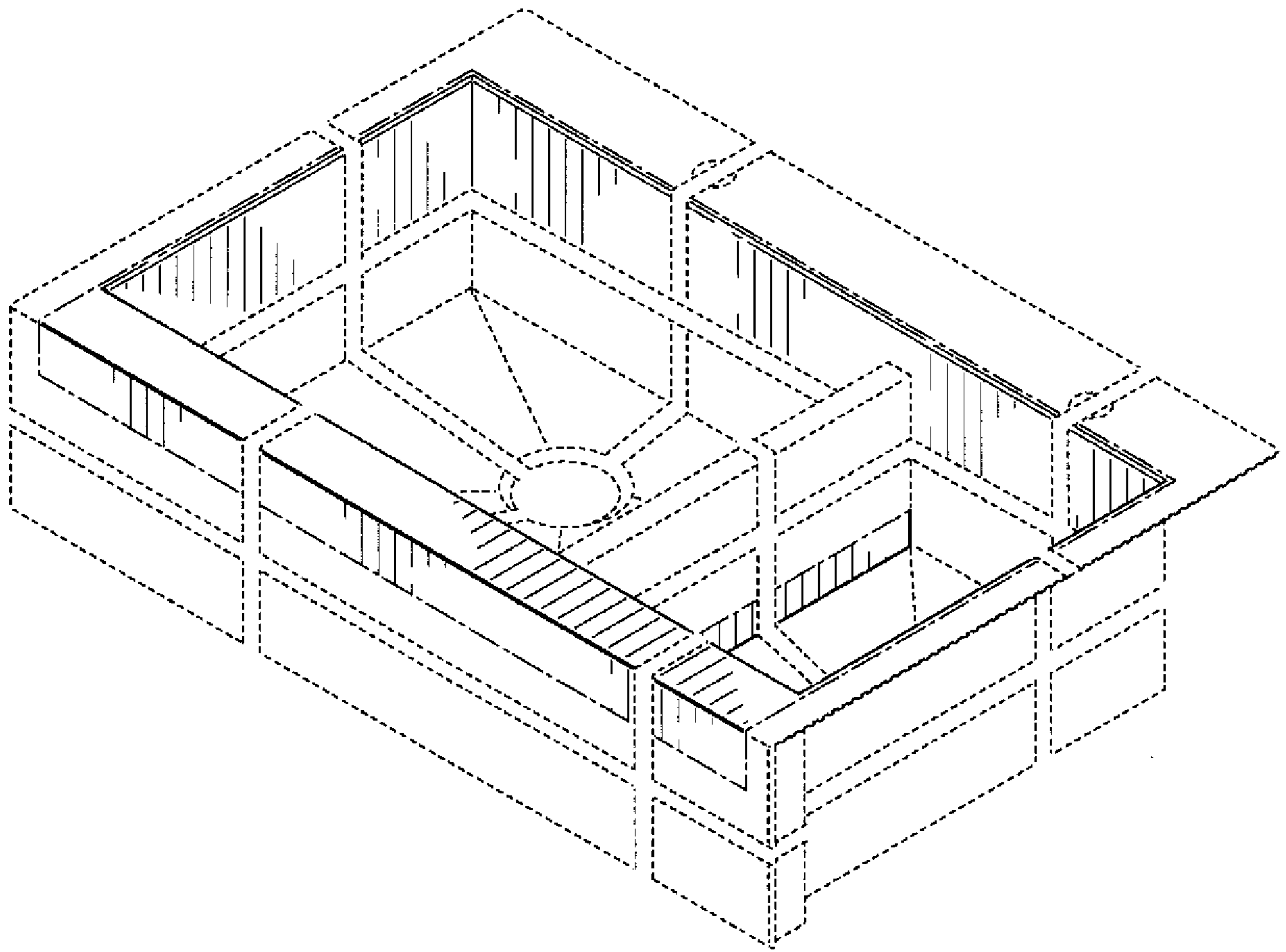

**FIG. 1**

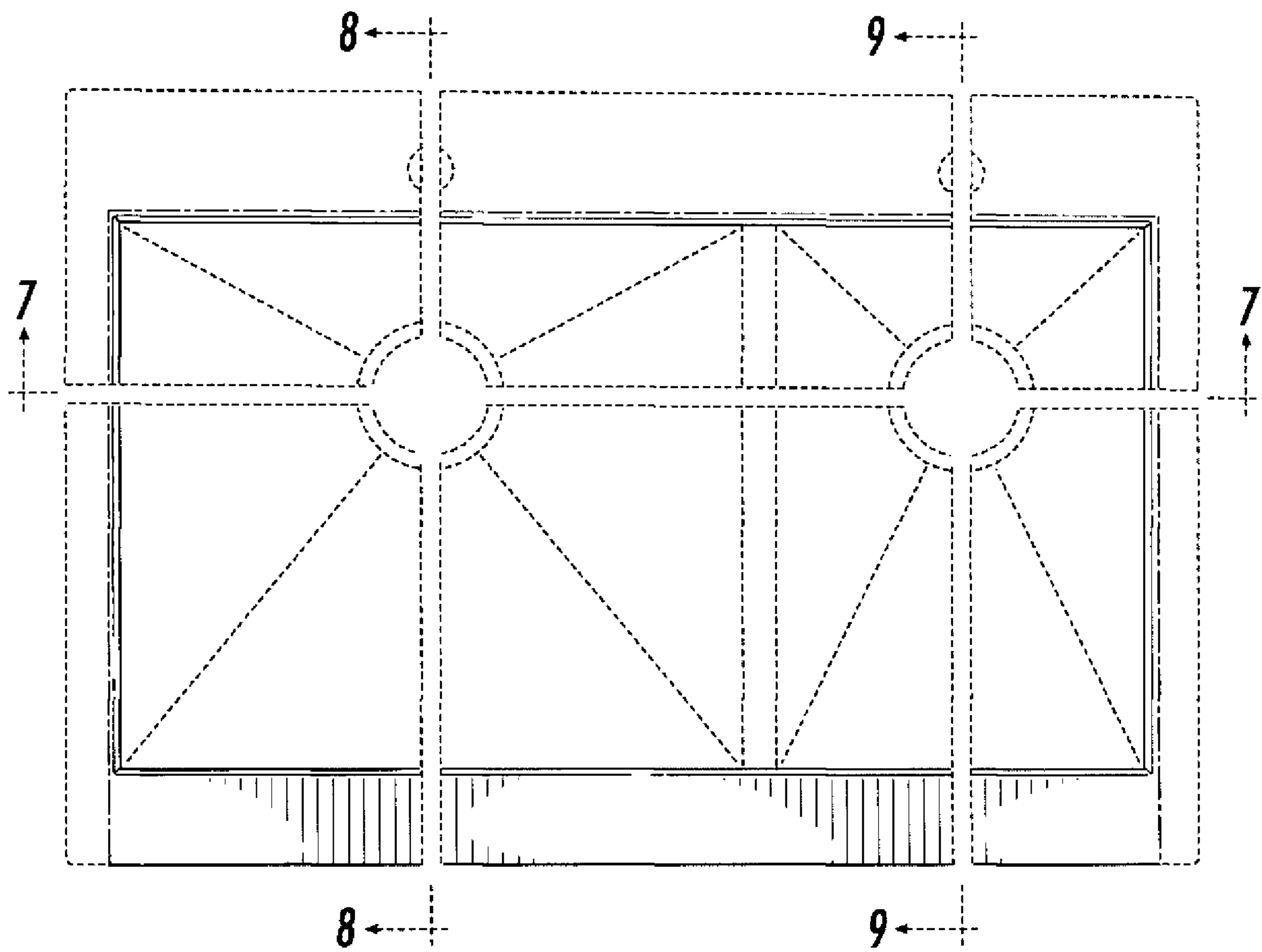

FIG. 2

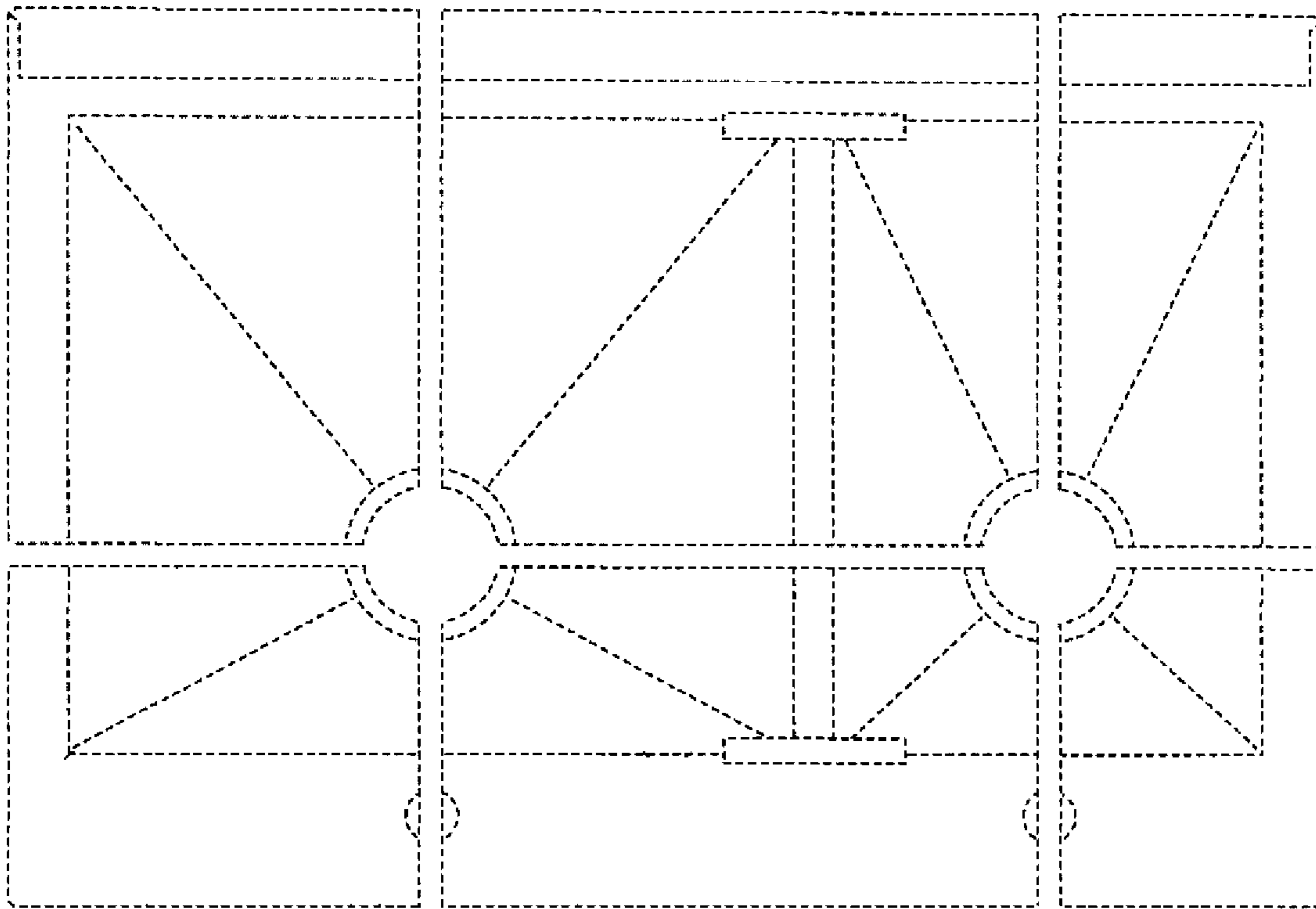
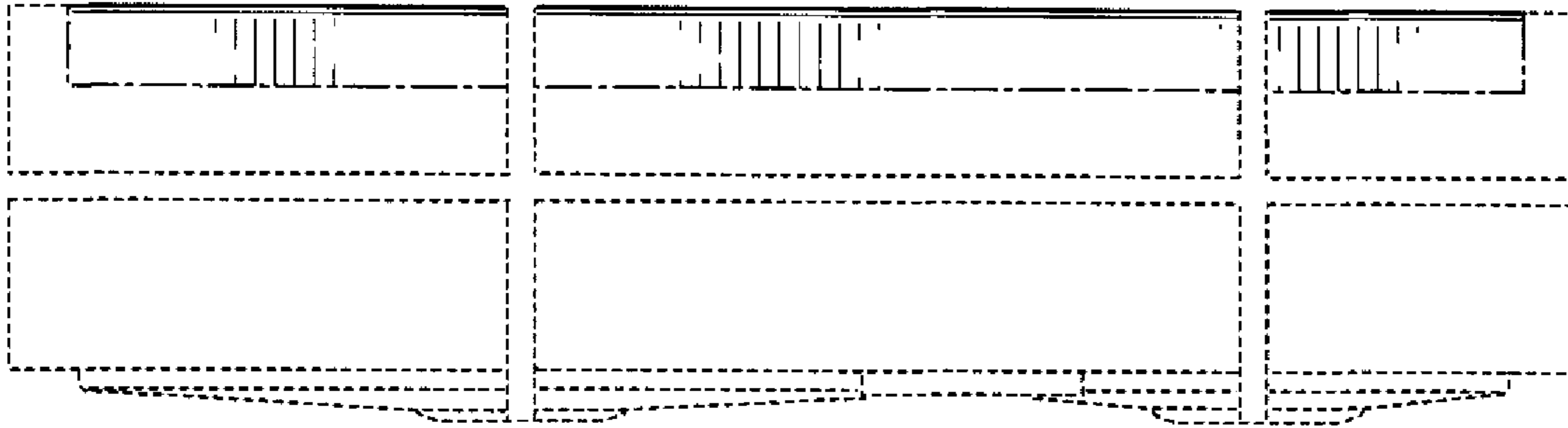
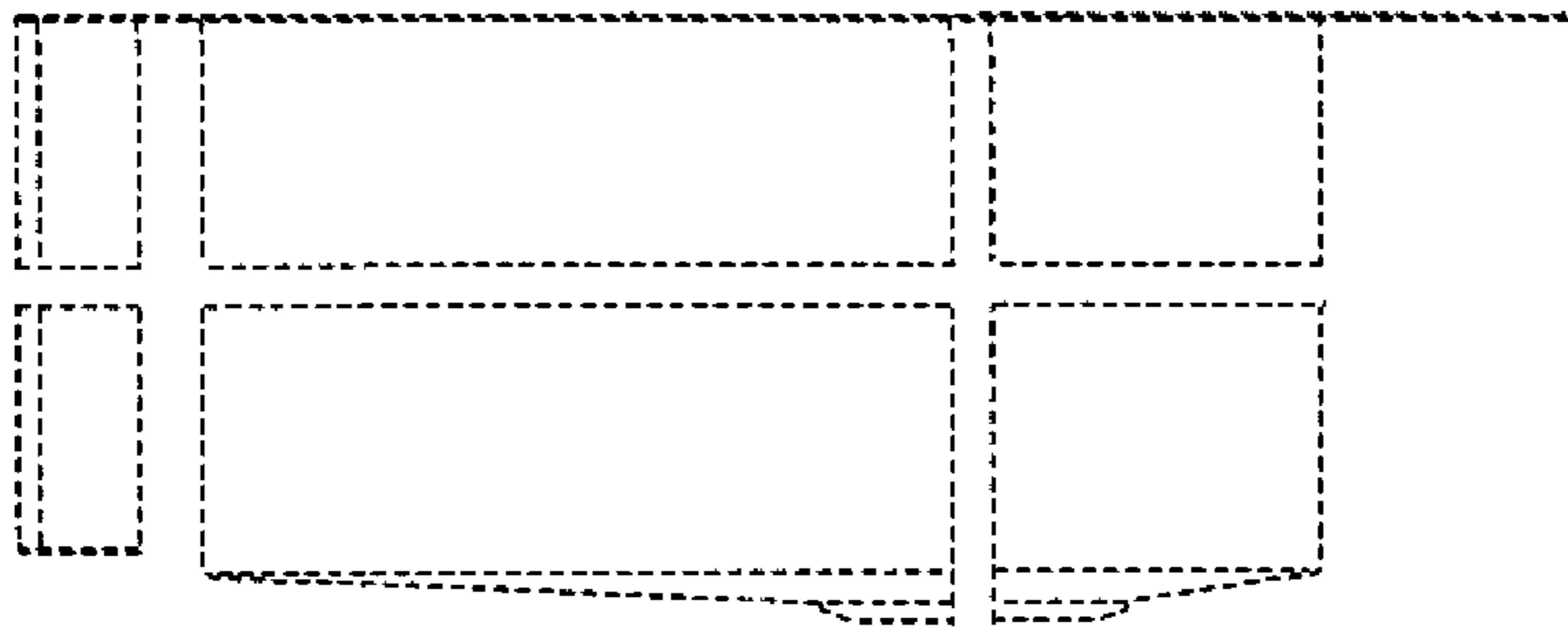

FIG. 3



**FIG. 4**



**FIG. 5**

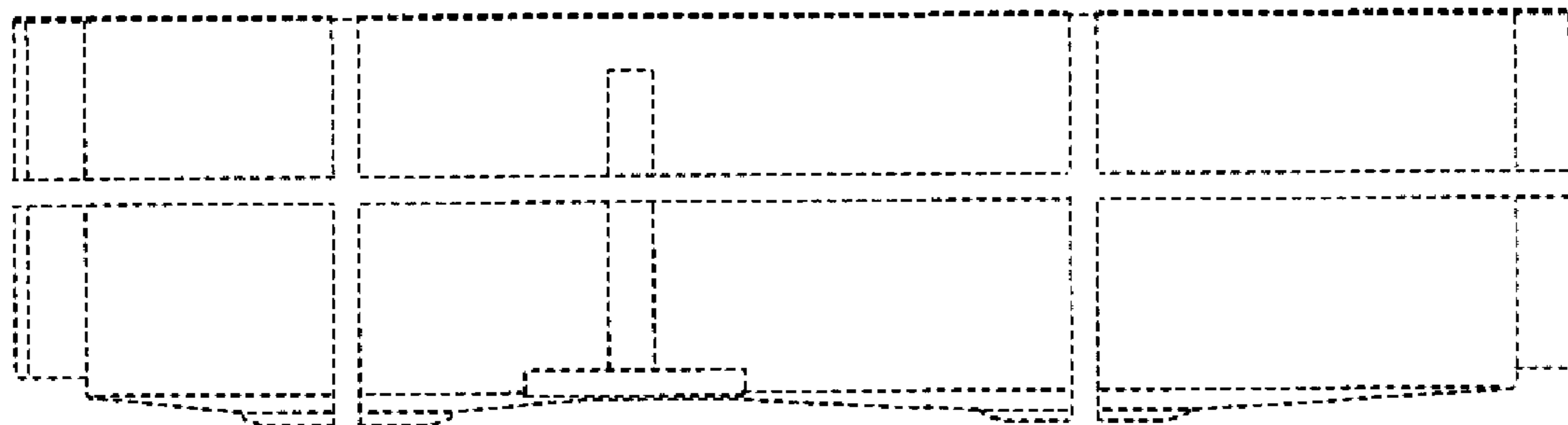

**FIG. 6**

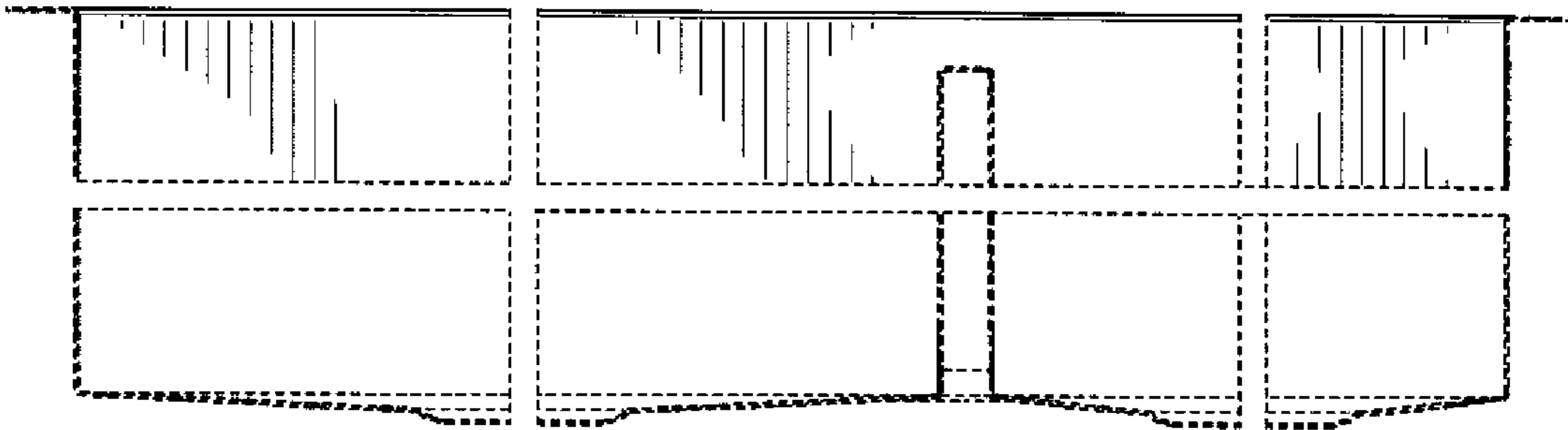

**FIG. 7**

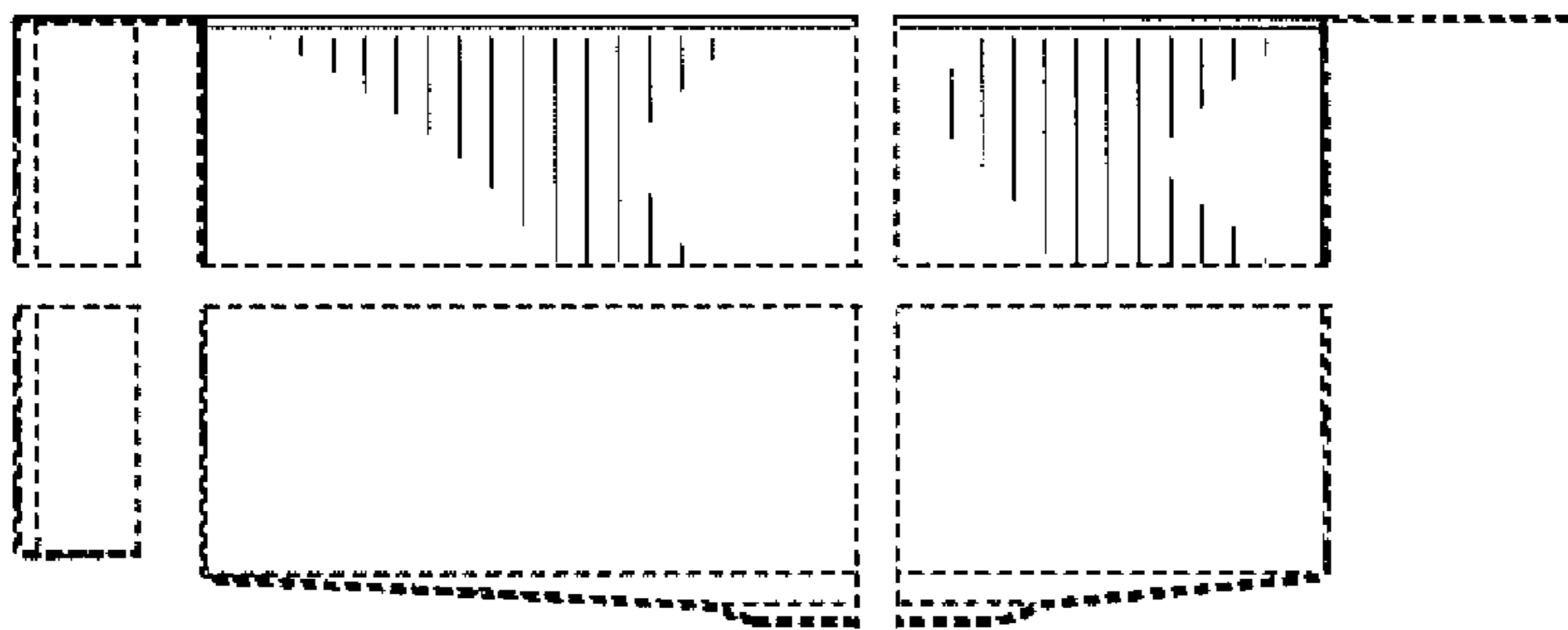

**FIG. 8**

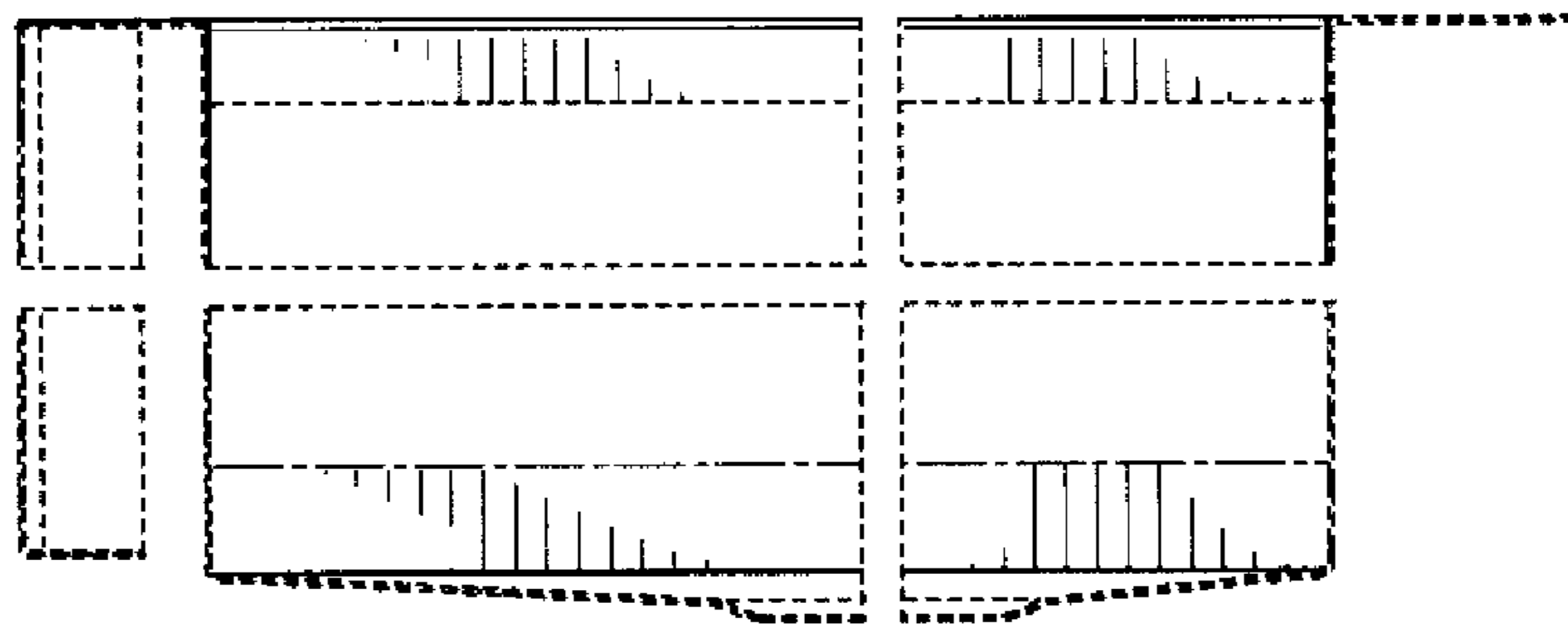

**FIG. 9**

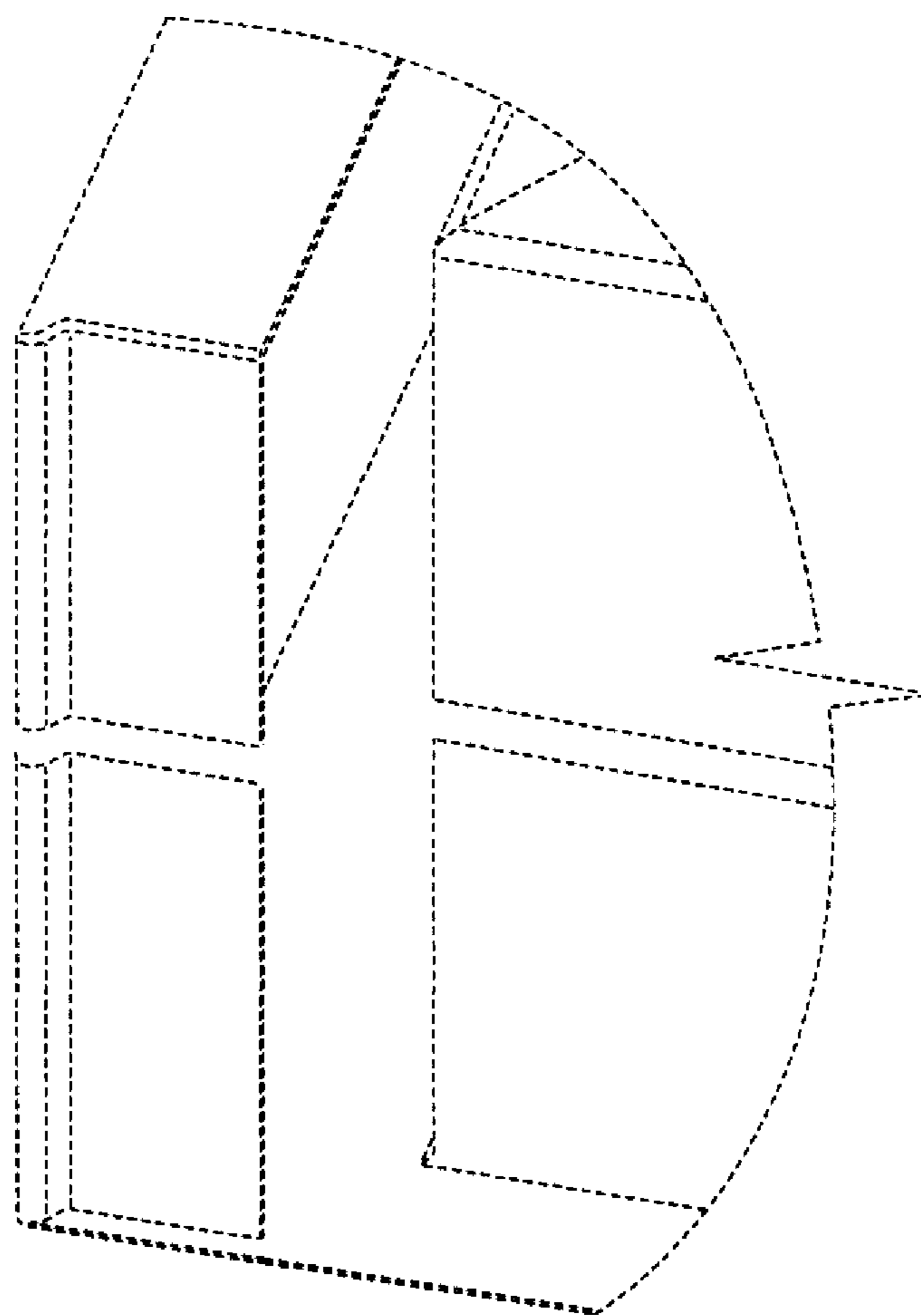

FIG. 10

UNITED STATES PATENT AND TRADEMARK OFFICE  
**CERTIFICATE OF CORRECTION**

PATENT NO. : D670,367 S  
APPLICATION NO. : 29/425479  
DATED : November 6, 2012  
INVENTOR(S) : Jason Miller et al.

Page 1 of 8

It is certified that error appears in the above-identified patent and that said Letters Patent is hereby corrected as shown below:

The title page should be deleted to appear as per attached title page.

In the Drawings:

Replace Figs. 1-10 with the attached drawing sheets.

This certificate supersedes the Certificate of Correction issued December 3, 2013.

Signed and Sealed this  
Fourth Day of February, 2014



Michelle K. Lee  
*Deputy Director of the United States Patent and Trademark Office*

(12) **United States Design Patent** (10) **Patent No.:** **US D670,367 S**  
**Miller et al.** (45) **Date of Patent:** **\*\* Nov. 6, 2012**

(54) **SINK**

(75) Inventors: **Jason Miller**, Sheboygan Falls, WI (US); **Terrence K. Mahon**, Whitefish Bay, WI (US); **Shawn J. Booth**, Sheboygan, WI (US); **Peter Tabeling**, Lakewood, OH (US)

(73) Assignee: **Kohler Co.**, Kohler, WI (US)

(\*\*) Term: **14 Years**

(21) Appl. No.: **29/425,479**

(22) Filed: **Jun. 22, 2012**

**Related U.S. Application Data**

(62) Division of application No. 29/412,242, filed on Feb. 1, 2012, now Pat. No. Des. 663,389, which is a division of application No. 29/386,884, filed on Mar. 4, 2011, now Pat. No. Des. 655,798.

(51) **LOC (9) Cl.** ..... **23-02**

(52) **U.S. Cl.** ..... **D23/308**

(58) **Field of Classification Search** ..... D23/284, D23/290-292, 293.1, 303, 308; 4/619, 639-640  
 See application file for complete search history.

(56) **References Cited**

**U.S. PATENT DOCUMENTS**

D353,652 S *	12/1994	Dannenberg	.....	D23/293.1
D484,956 S *	1/2004	Rachiele	.....	D23/293.1
D492,983 S *	7/2004	Rachiele	.....	D23/293.1
D498,291 S *	11/2004	Bayer	.....	D23/290
D508,984 S *	8/2005	Gordon	.....	D23/293.1
D527,808 S *	9/2006	Wozniczka et al.	.....	D23/290
D546,929 S *	7/2007	Schneider et al.	.....	D23/290
D585,126 S *	1/2009	Eilmus et al.	.....	D23/290
D603,486 S *	11/2009	Mayer et al.	.....	D23/293.1

**OTHER PUBLICATIONS**

Rachiele; "Patented copper apron front sink with channel;" [http://www.rachiele.com/copper\\_apron\\_sinks-with-patent.asp](http://www.rachiele.com/copper_apron_sinks-with-patent.asp); retrieval date: Nov. 30, 2011; 3 pages.

\* cited by examiner

*Primary Examiner* — Robert Delehanty

(74) *Attorney, Agent, or Firm* — Foley & Lardner LLP

(57) **CLAIM**

We claim the ornamental design for a sink, as shown and described.

**DESCRIPTION**

FIG. 1 is a top perspective view of an embodiment of the claimed design;  
 FIG. 2 is a top plan view of the claimed design of FIG. 1;  
 FIG. 3 is a bottom plan view of the claimed design of FIG. 1;  
 FIG. 4 is a front elevation view of the claimed design of FIG. 1;  
 FIG. 5 is a right-side elevation view of the claimed design of FIG. 1;  
 FIG. 6 is a rear elevation view of the claimed design of FIG. 1;  
 FIG. 7 is a cross-sectional view of FIG. 2;  
 FIG. 8 is another cross-sectional view of FIG. 2;  
 FIG. 9 is another cross-sectional view of FIG. 2; and,  
 FIG. 10 is a detailed bottom perspective view of the claimed design of FIG. 1 showing a left end of a front apron.  
 The ornamental design which is claimed is shown in solid lines in the drawings. The broken lines in the drawings are for illustrative purposes only and form no part of the claimed design.

**1 Claim, 6 Drawing Sheets**

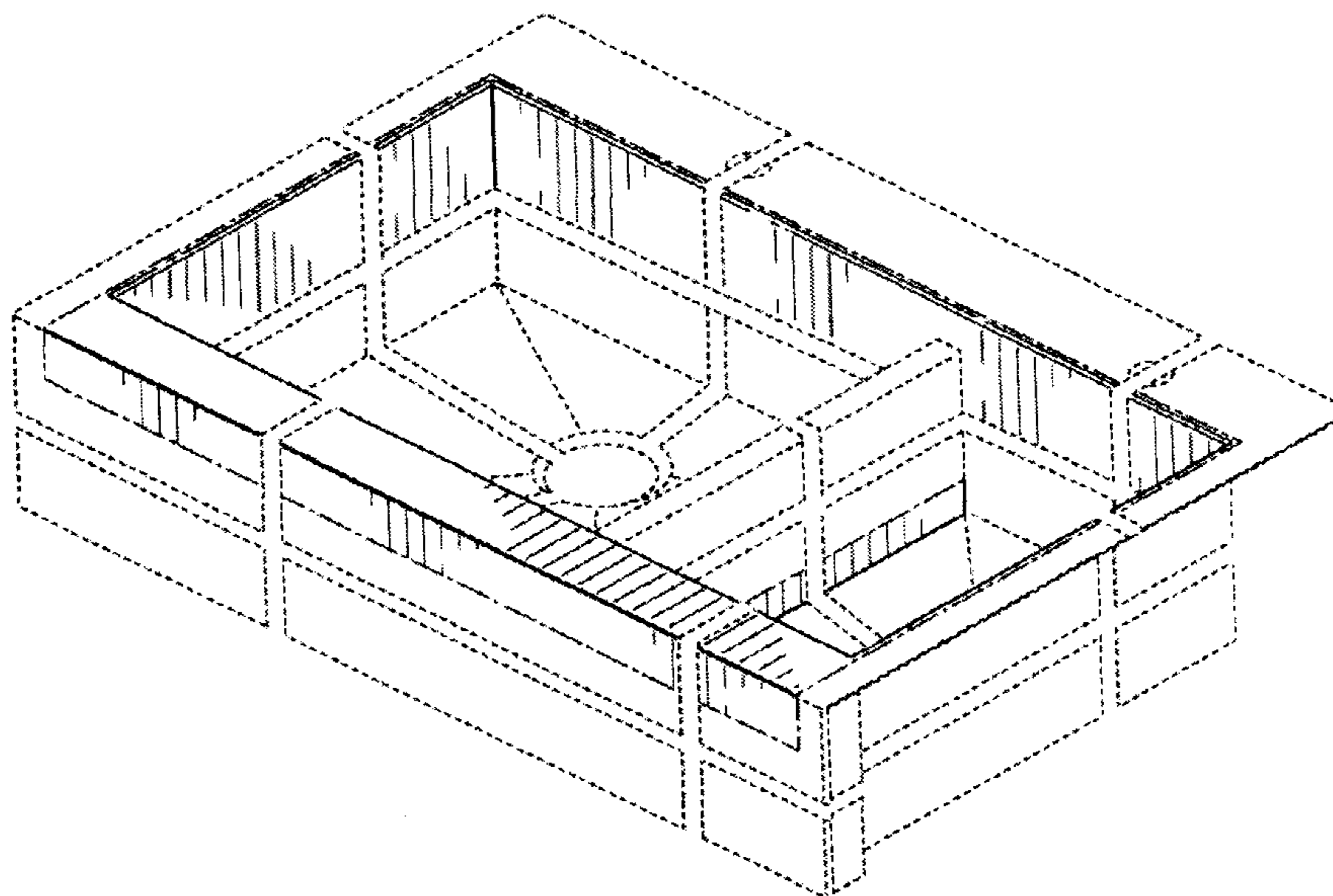



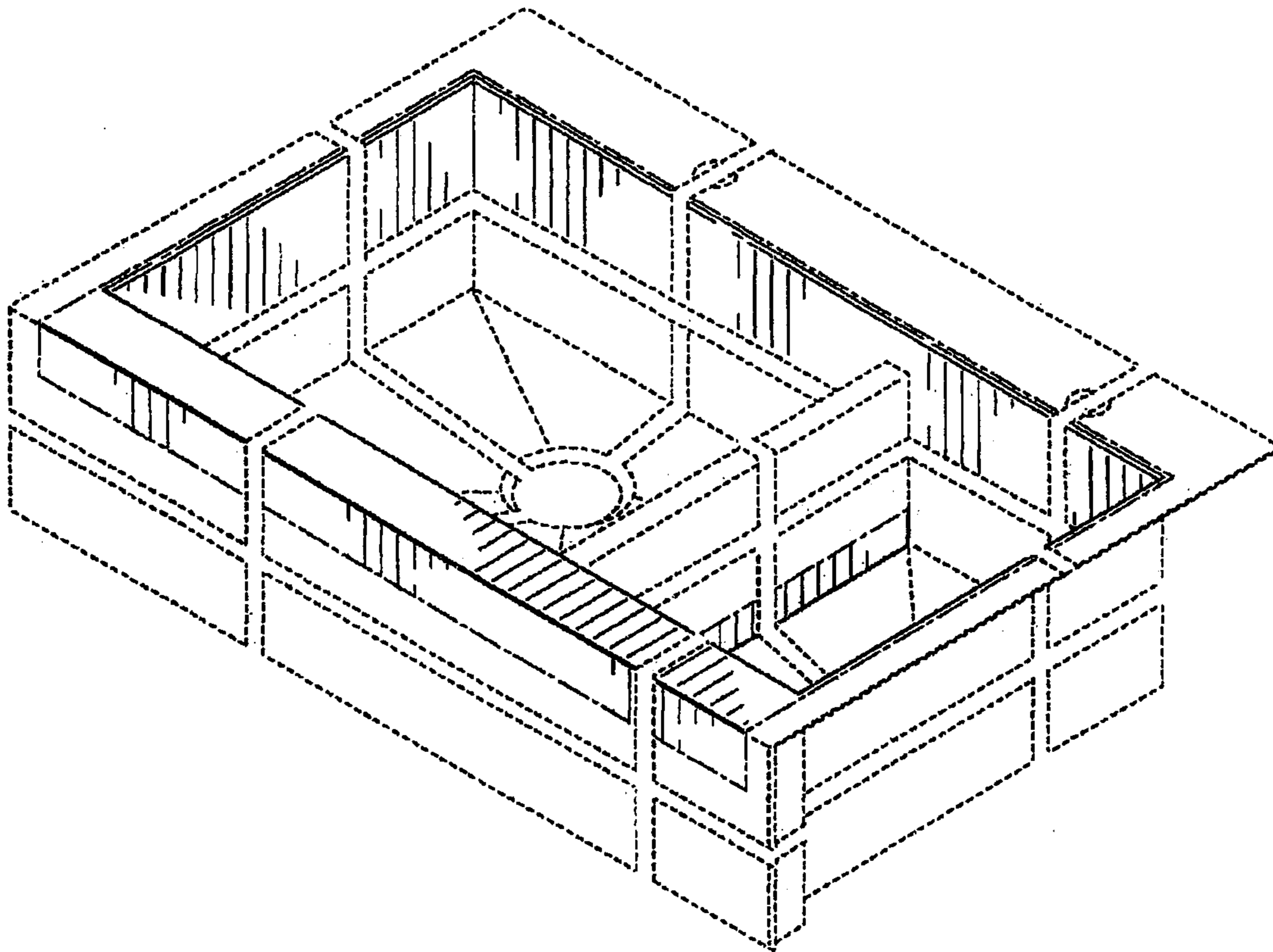

**FIG. 1**

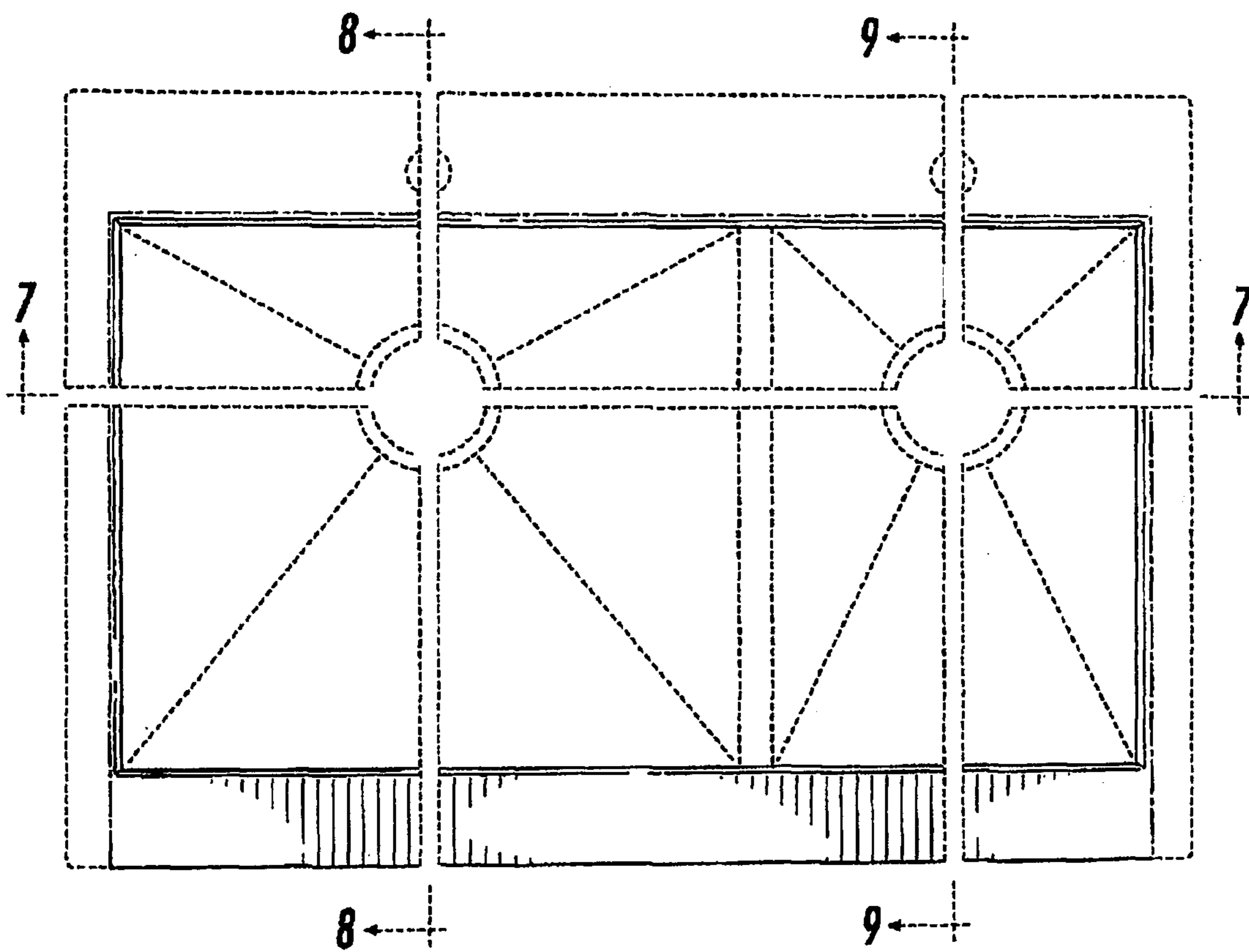
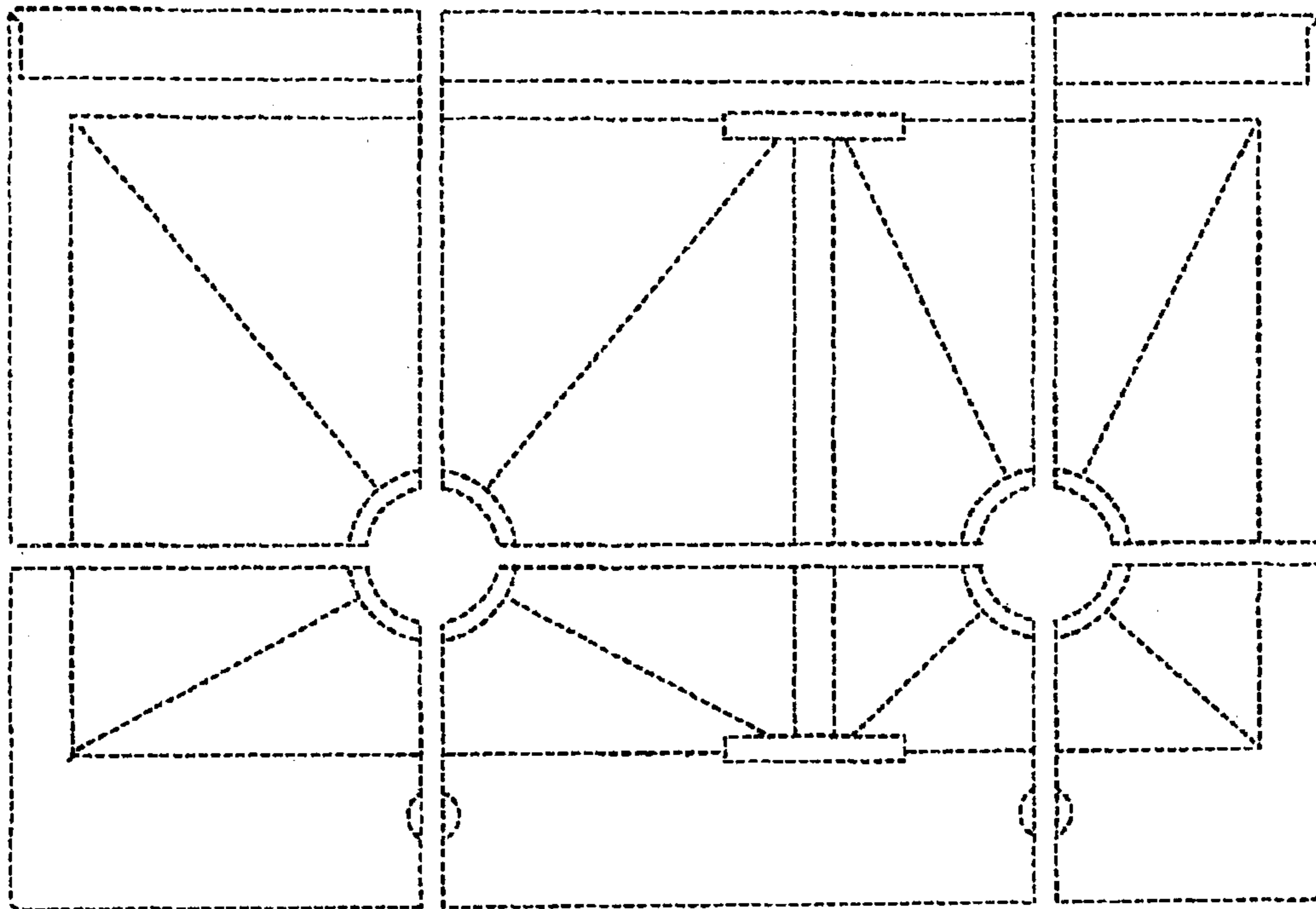

FIG. 2



**FIG. 3**

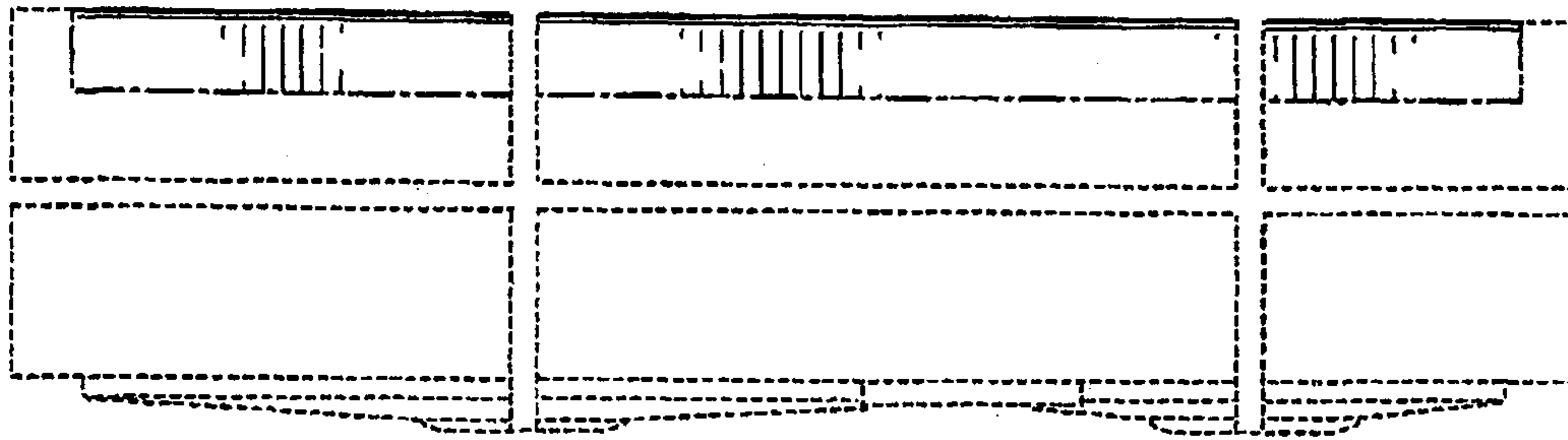

FIG. 4

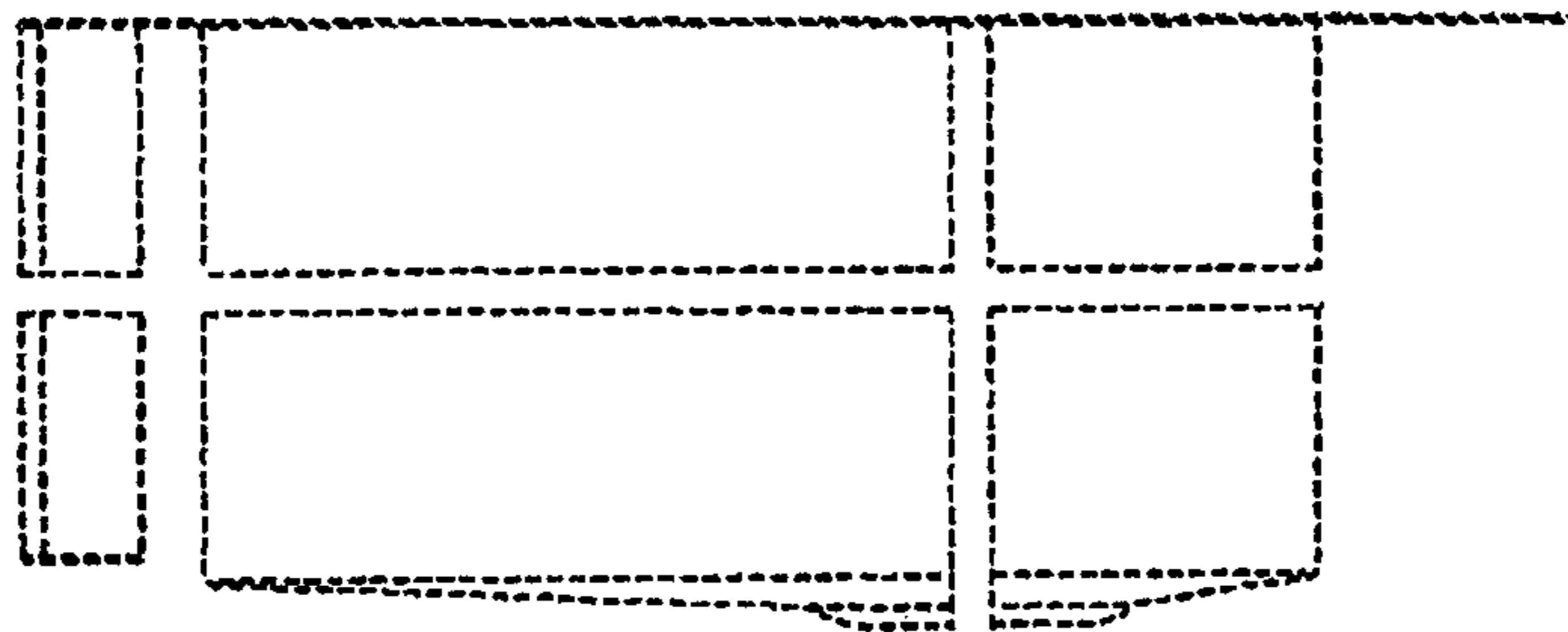

FIG. 5

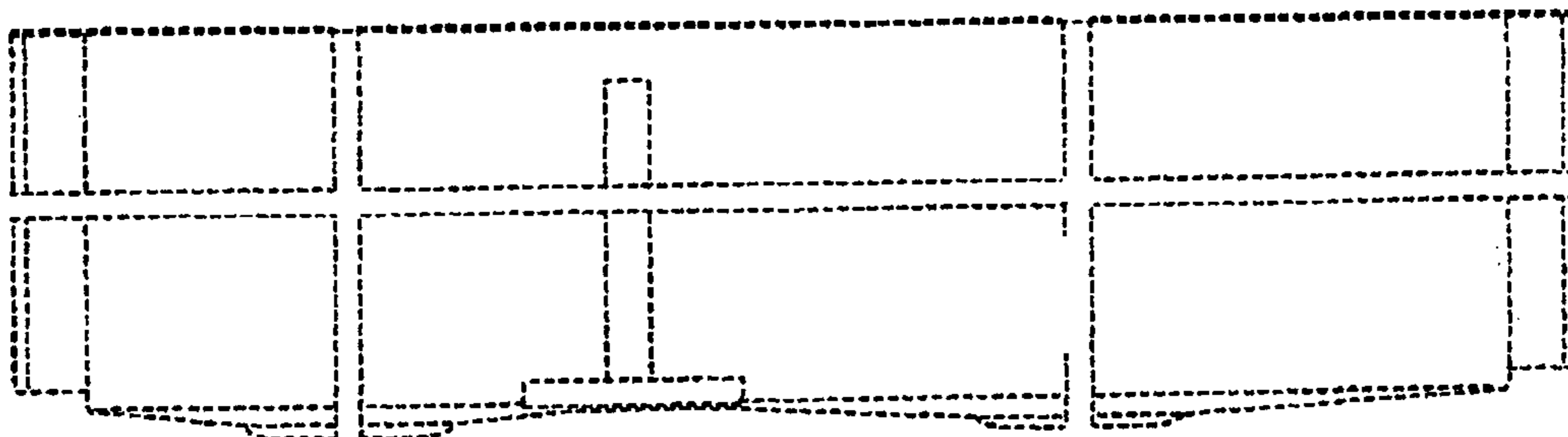
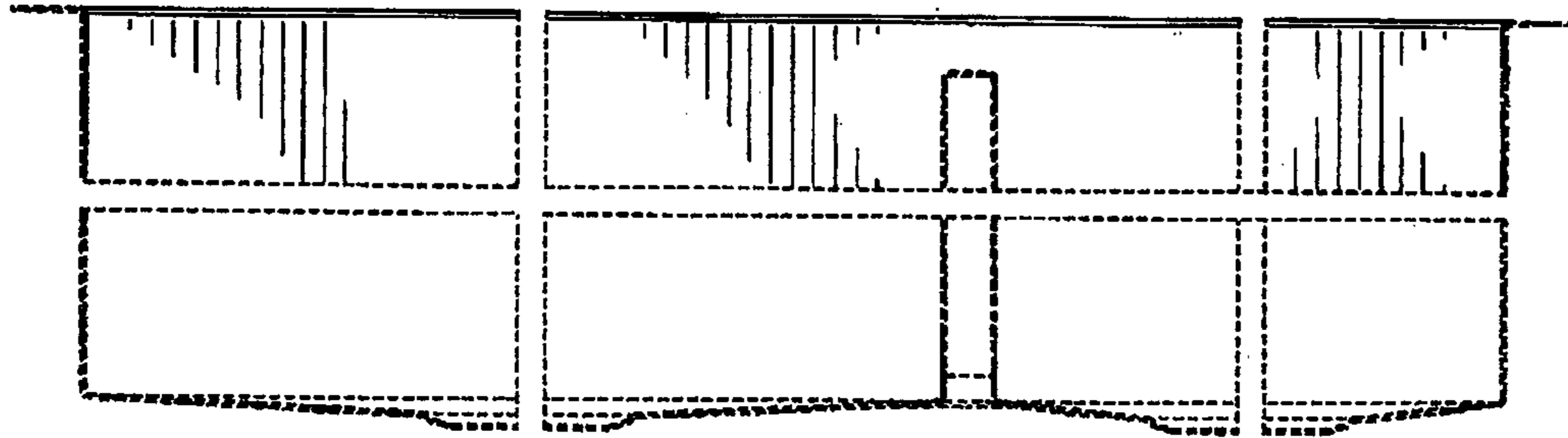
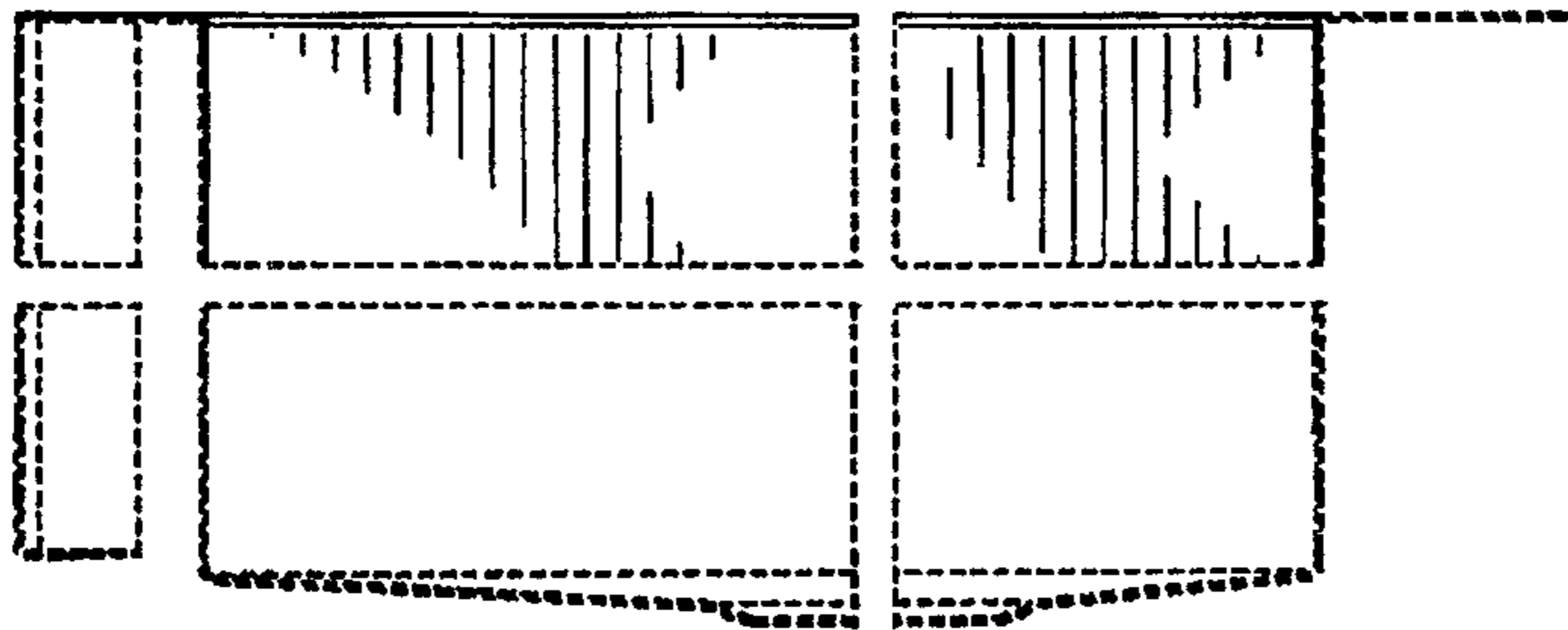

FIG. 6



**FIG. 7**



**FIG. 8**

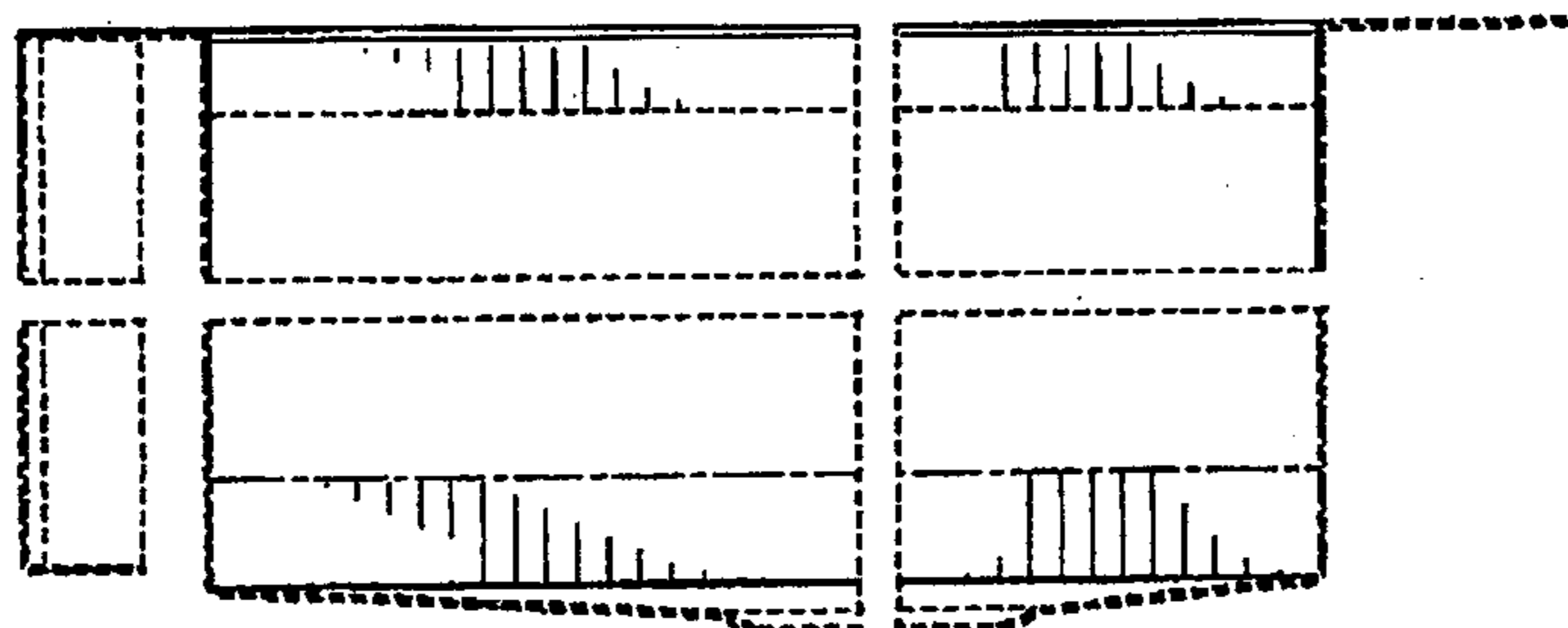

**FIG. 9**

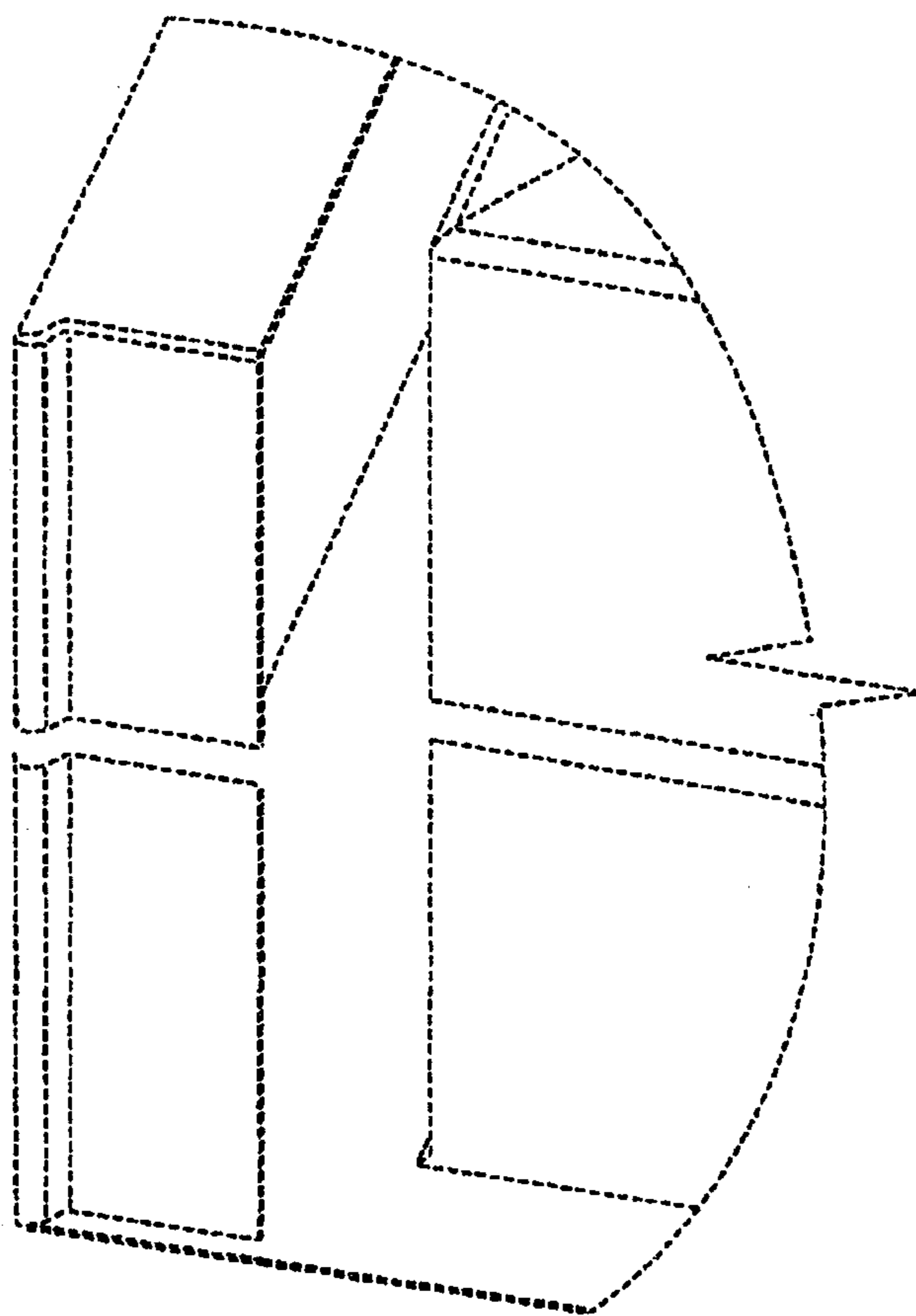

FIG. 10