

US00D670298S

(12) **United States Design Patent**
Shimozaki

(10) **Patent No.:** **US D670,298 S**
(45) **Date of Patent:** **** Nov. 6, 2012**

(54) **ROTATIONAL DAMPER**

(75) Inventor: **Kei Shimozaki**, Yokohama (JP)

(73) Assignee: **Nifco Inc.**, Yokohama-Shi (JP)

(**) Term: **14 Years**

(21) Appl. No.: **29/371,751**

(22) Filed: **Aug. 30, 2011**

(30) **Foreign Application Priority Data**

Mar. 2, 2011 (JP) 2011-004760

(51) **LOC (9) Cl.** **14-99**

(52) **U.S. Cl.** **D14/483**

(58) **Field of Classification Search** D14/299,
D14/474-483, 496; D8/323, 499; D15/143,
D15/147, 199; 188/262, 290, 371, 378; 360/137,
360/220, 221.1, 230; 475/92; 464/180
See application file for complete search history.

(56) **References Cited**

U.S. PATENT DOCUMENTS

4,513,473	A *	4/1985	Omata	16/82
4,614,004	A *	9/1986	Oshida	16/82
4,869,125	A *	9/1989	Saigusa	464/180
5,277,282	A *	1/1994	Umemura	188/290
5,718,309	A *	2/1998	Kariya	188/290
6,604,614	B2 *	8/2003	Kurihara et al.	188/290
D479,242	S *	9/2003	Kurachi et al.	D14/483
D486,833	S *	2/2004	Koizumi et al.	D14/483

D494,601	S *	8/2004	Arisaka et al.	D14/483
D494,602	S *	8/2004	Arisaka et al.	D14/483
D540,809	S *	4/2007	Okabayashi et al.	D14/483
7,264,096	B2 *	9/2007	Hayashi et al.	188/290
D566,122	S *	4/2008	Takei	D14/483
D566,123	S *	4/2008	Takei	D14/483
7,424,939	B2 *	9/2008	Hayashi et al.	188/290
D584,315	S *	1/2009	Yamaguchi	D14/483
7,959,201	B2 *	6/2011	Staib	296/37.12
2005/0115784	A1 *	6/2005	Muller et al.	188/290
2006/0011428	A1 *	1/2006	Hayashi et al.	188/290

* cited by examiner

Primary Examiner — Austin Murphy

(74) *Attorney, Agent, or Firm* — Manabu Kanesaka

(57) **CLAIM**

The ornamental design for a rotational damper, as shown and described.

DESCRIPTION

FIG. 1 is a front view of a rotational damper showing my new design;

FIG. 2 is rear view thereof;

FIG. 3 is left side view thereof;

FIG. 4 is right side view thereof;

FIG. 5 is a top plan view thereof;

FIG. 6 is a bottom plan view;

FIG. 7 is a cross-sectional view thereof taken along the line 7-7 in FIG. 5;

FIG. 8 is a cross-sectional view thereof taken along the line 8-8 in FIG. 1; and,

FIG. 9 is a perspective view thereof.

1 Claim, 5 Drawing Sheets

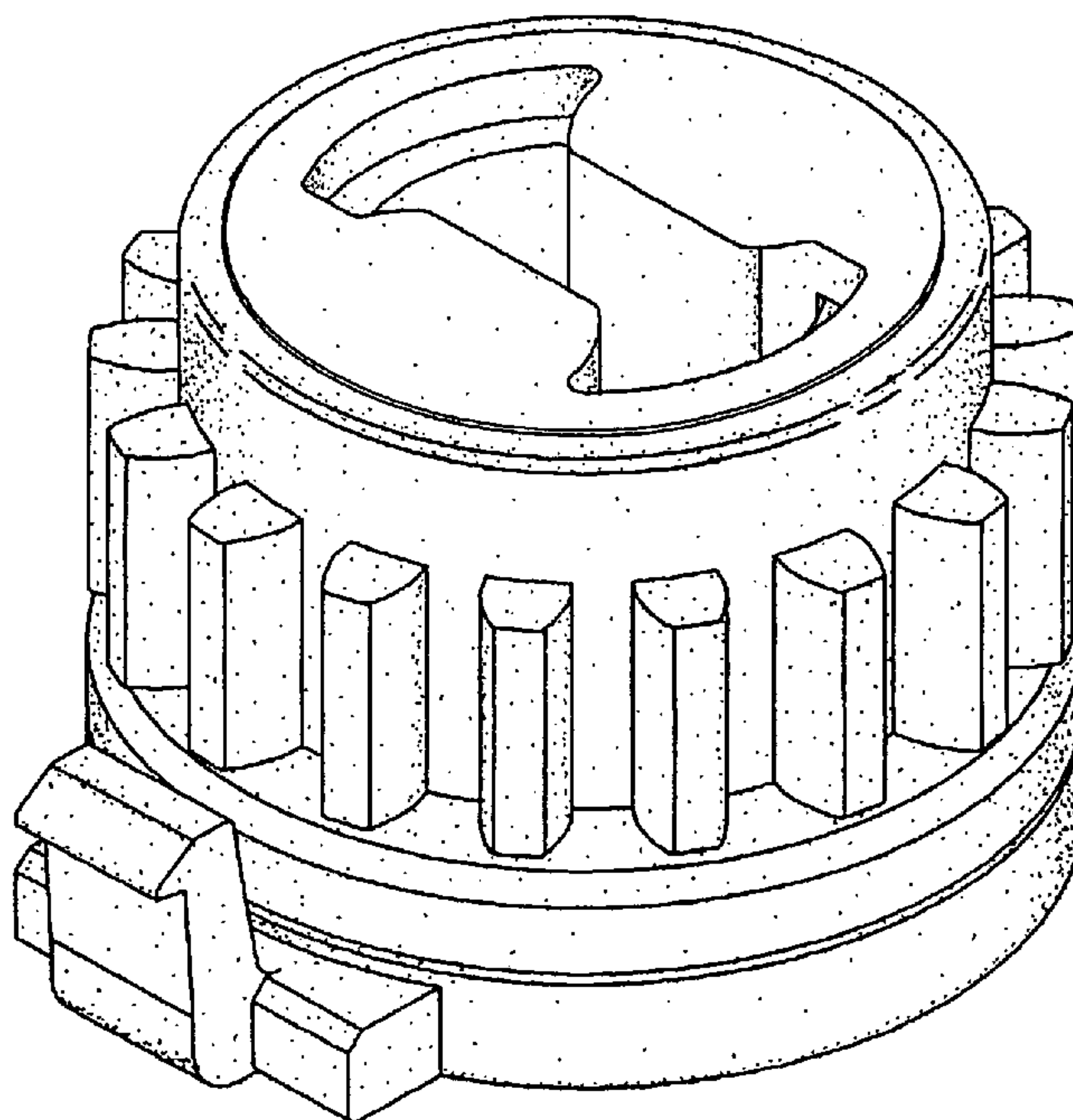

FIG. 1

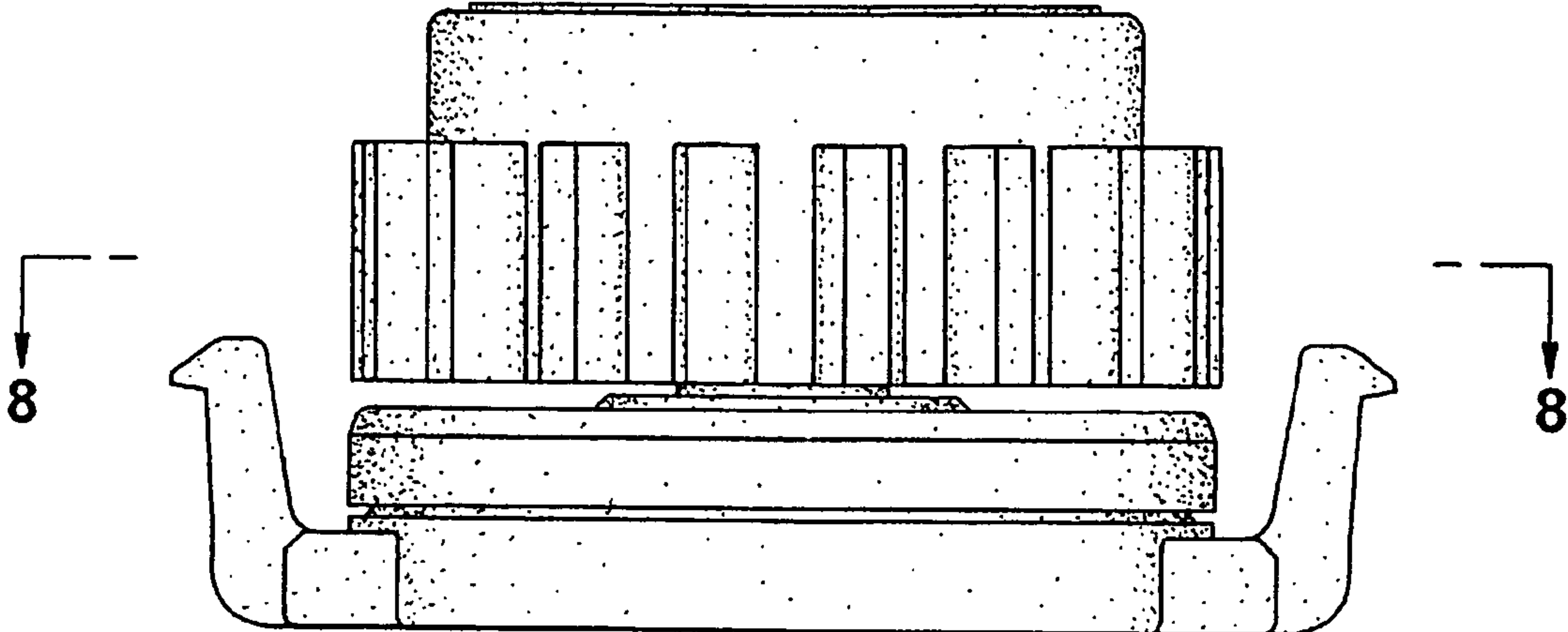

FIG. 2

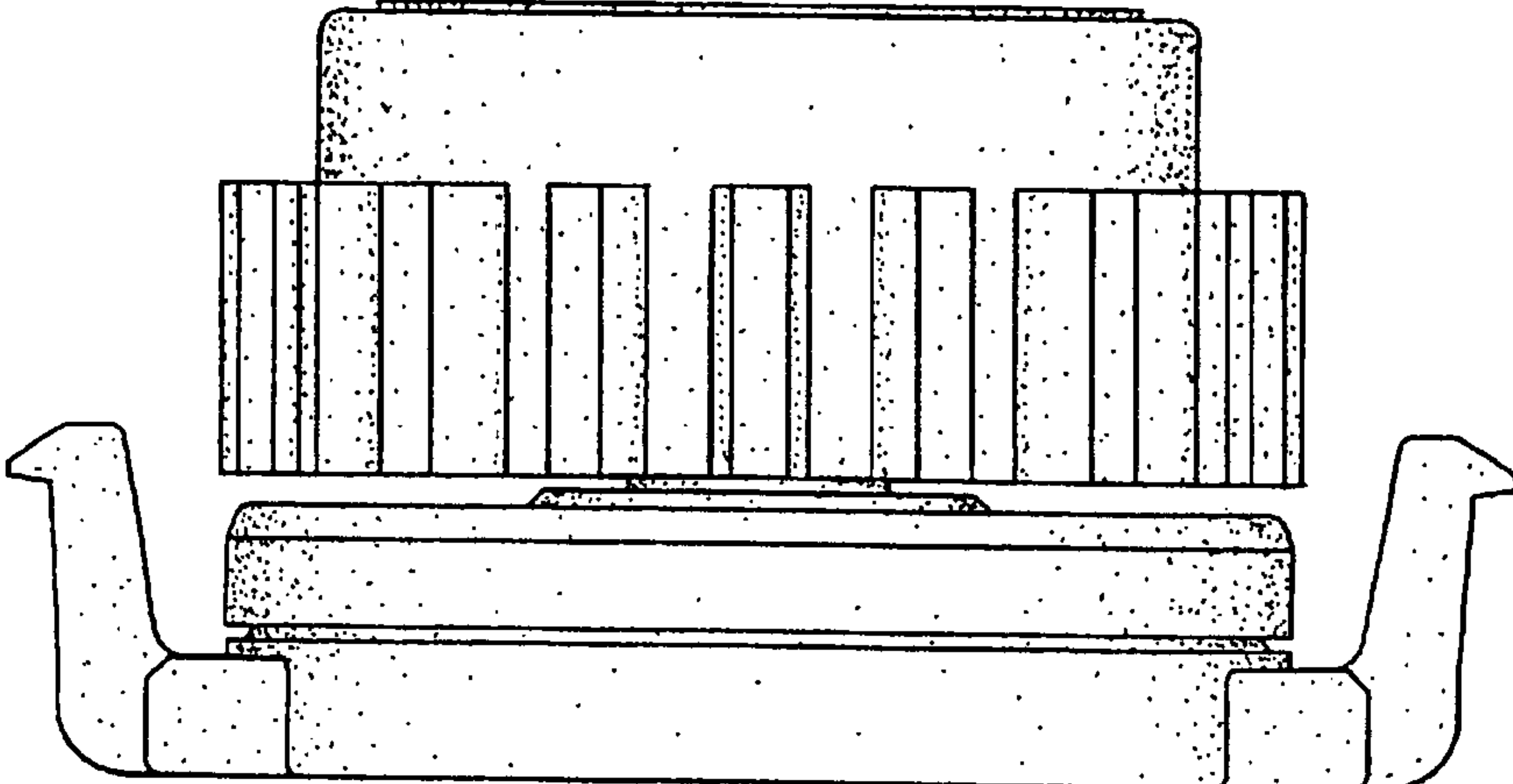

FIG. 3

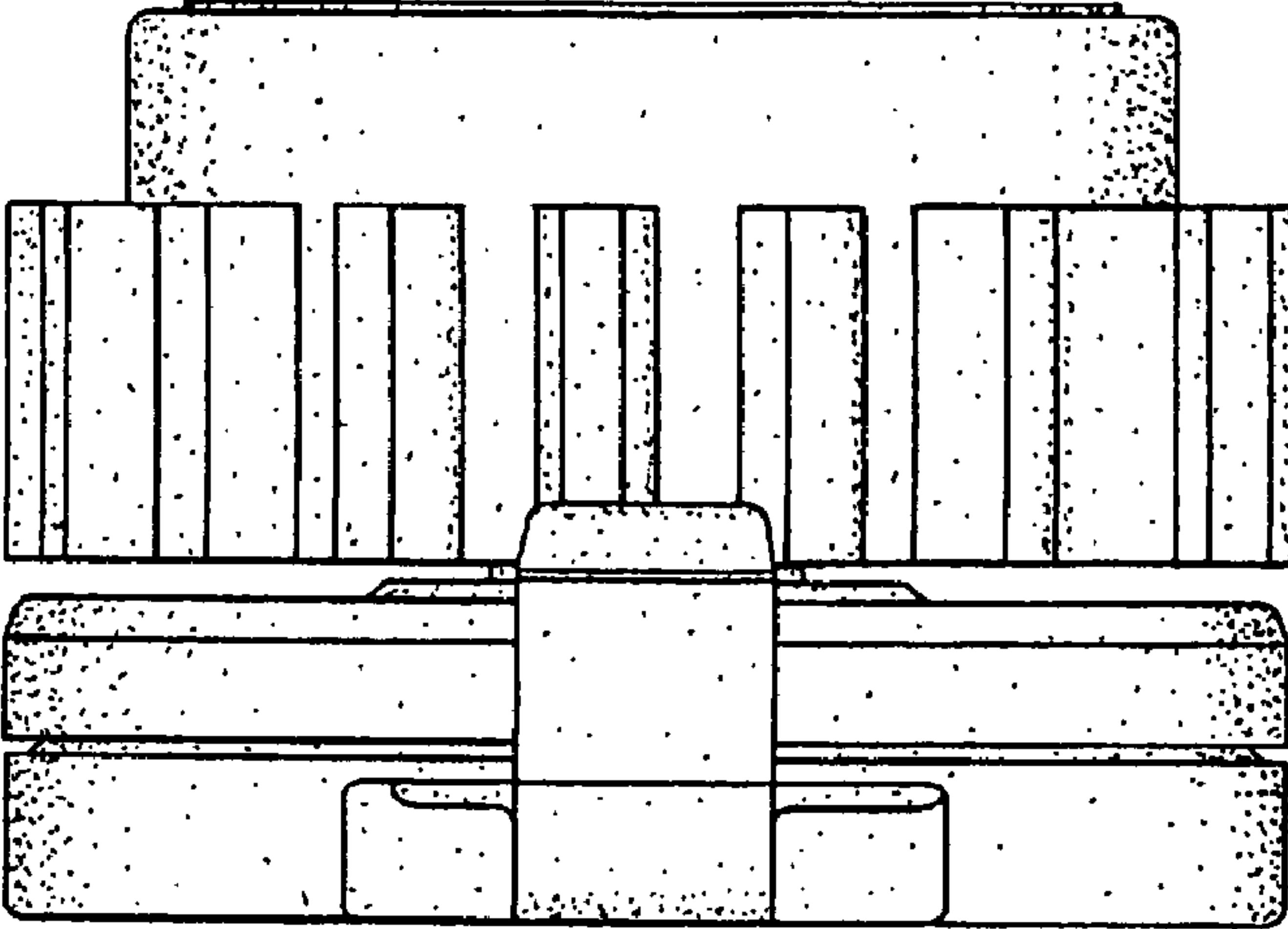

FIG. 4

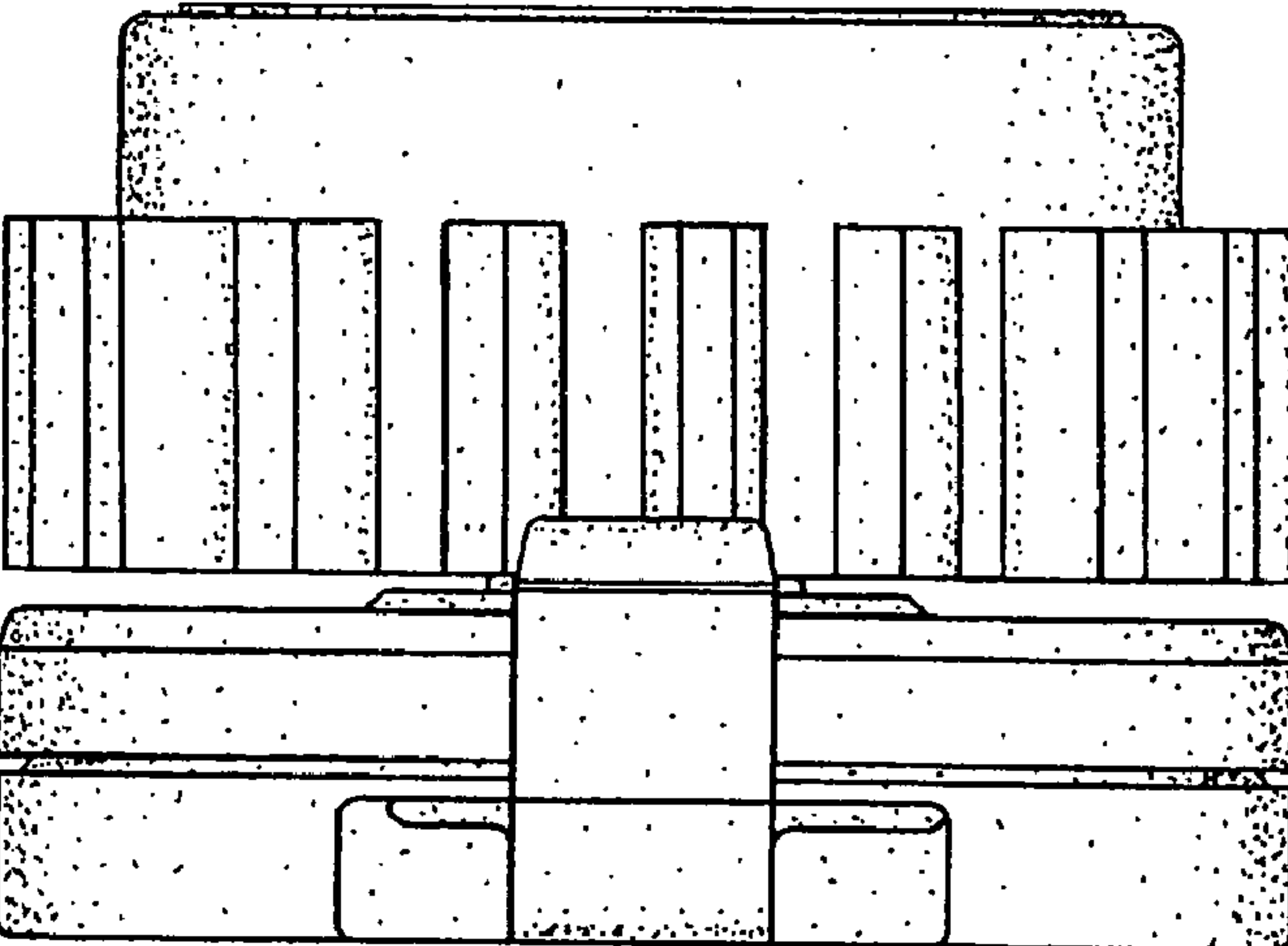

FIG. 5

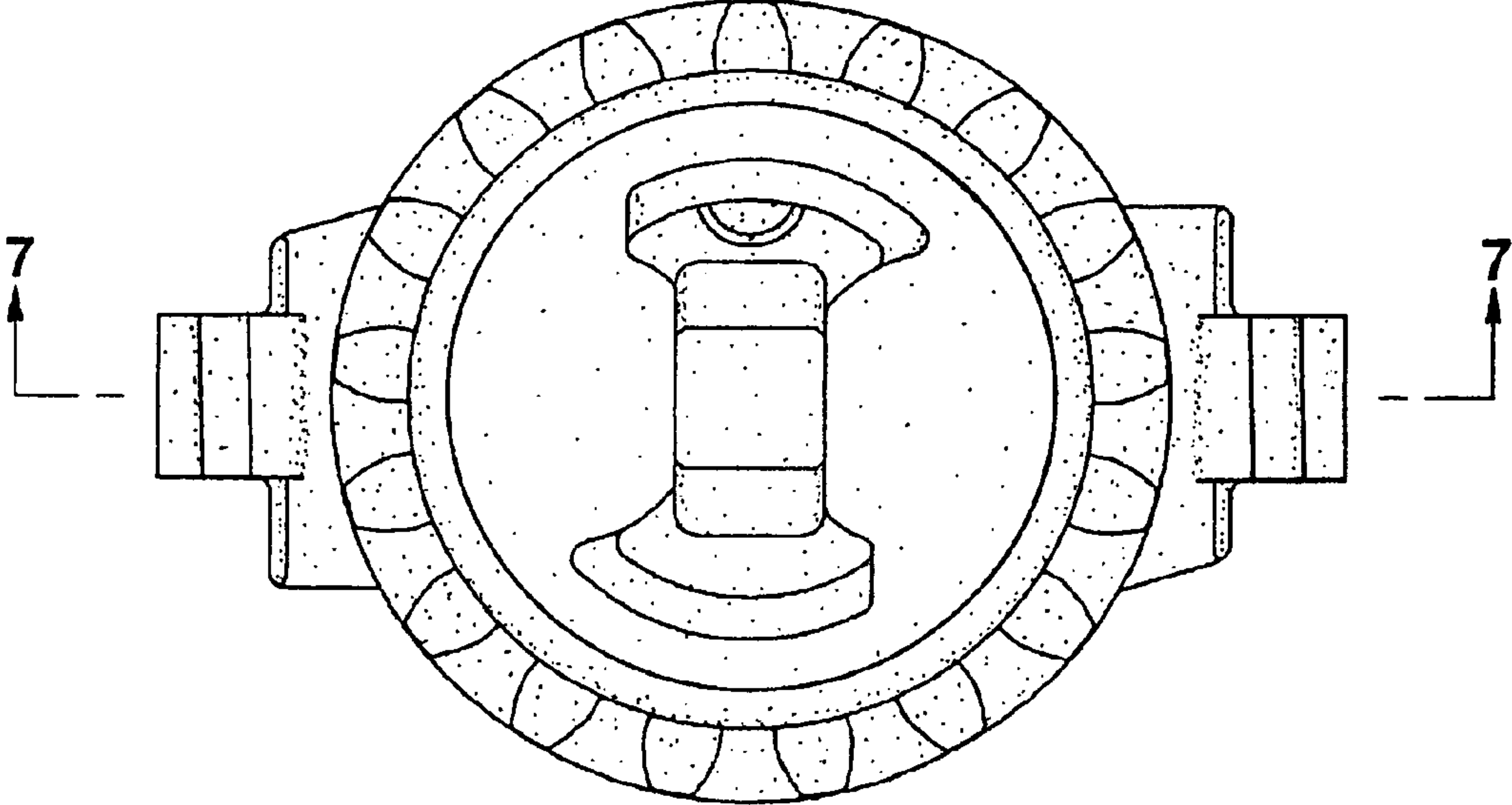

FIG. 6

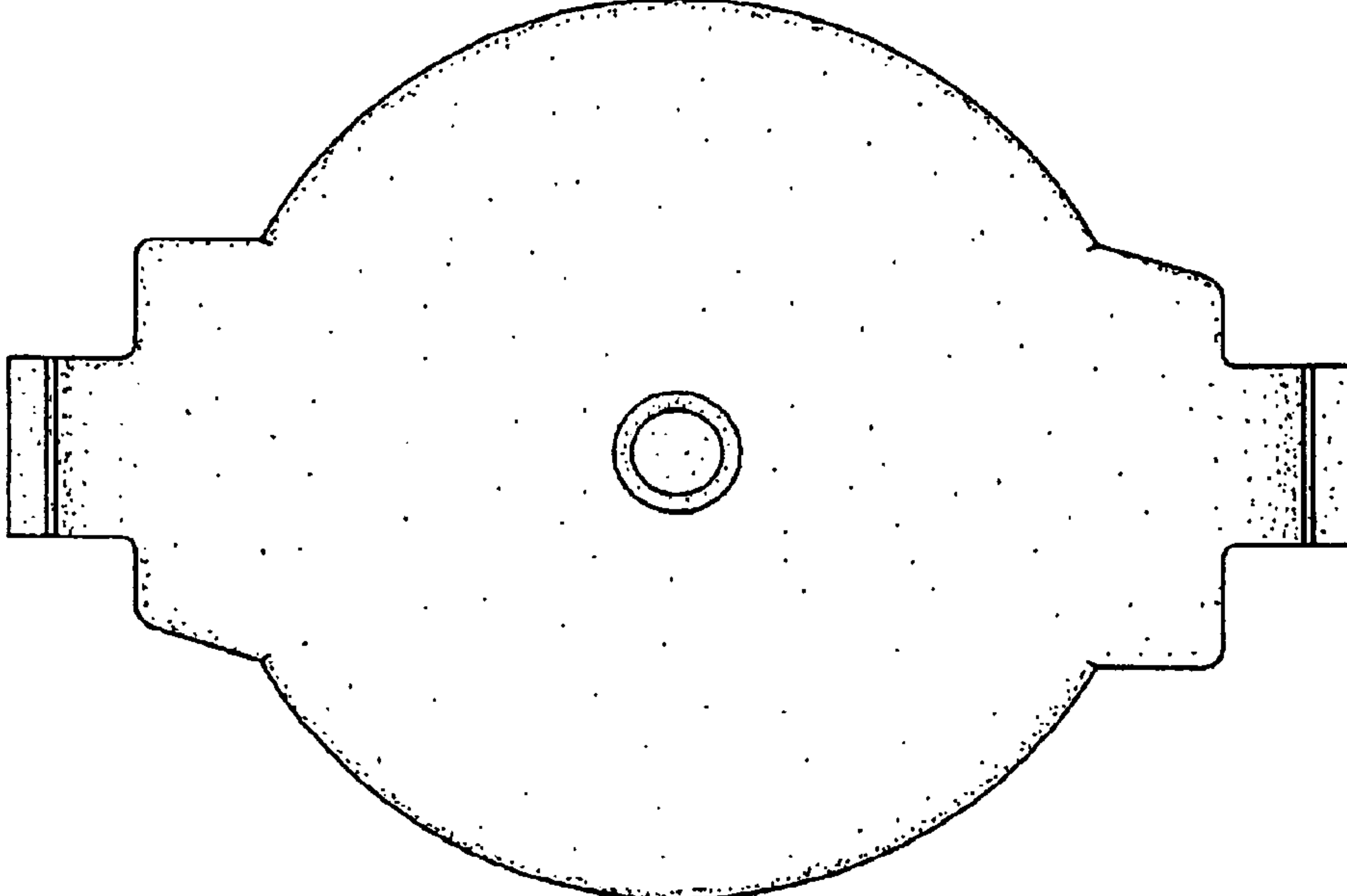

FIG. 7

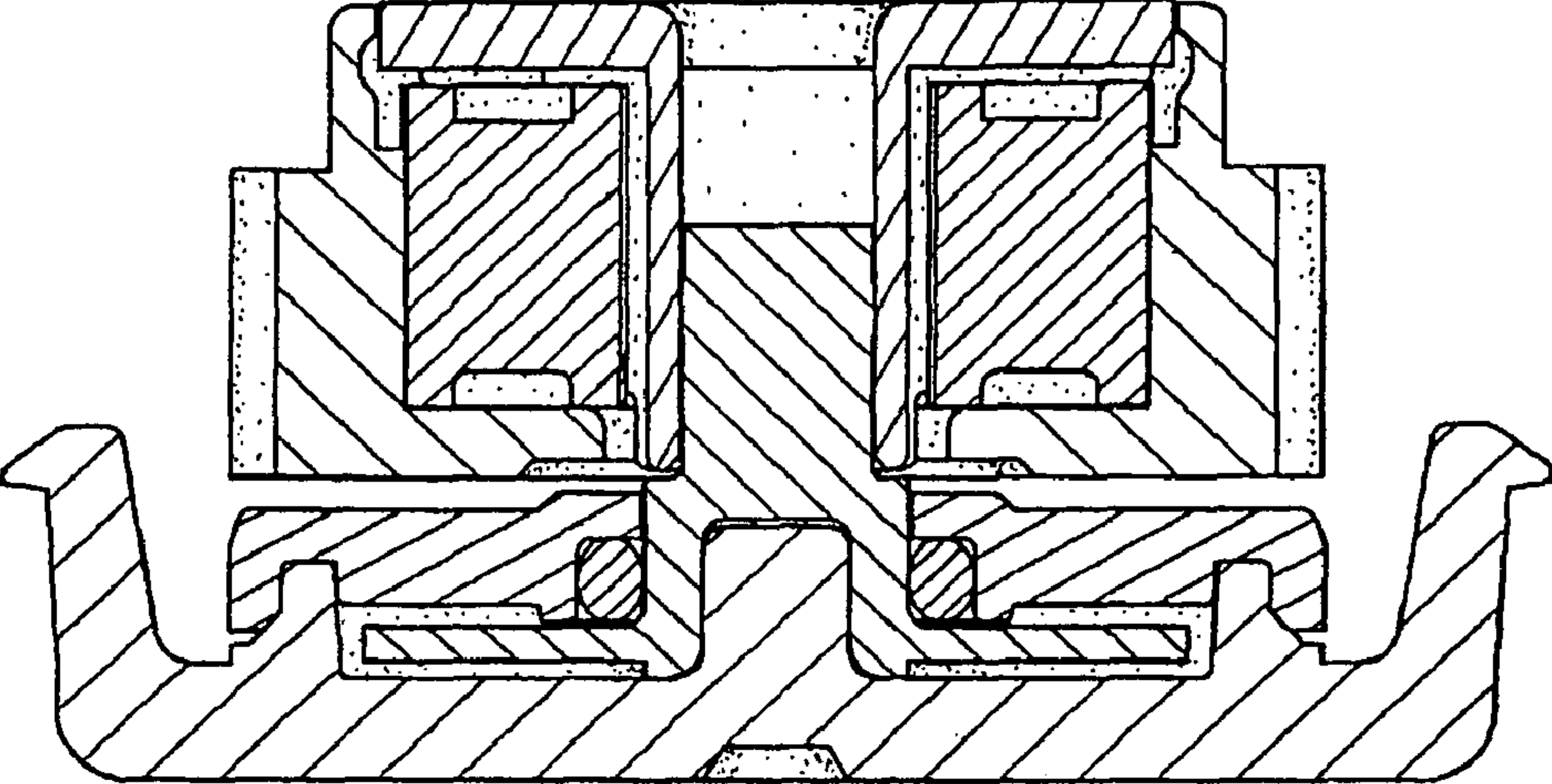

FIG. 8

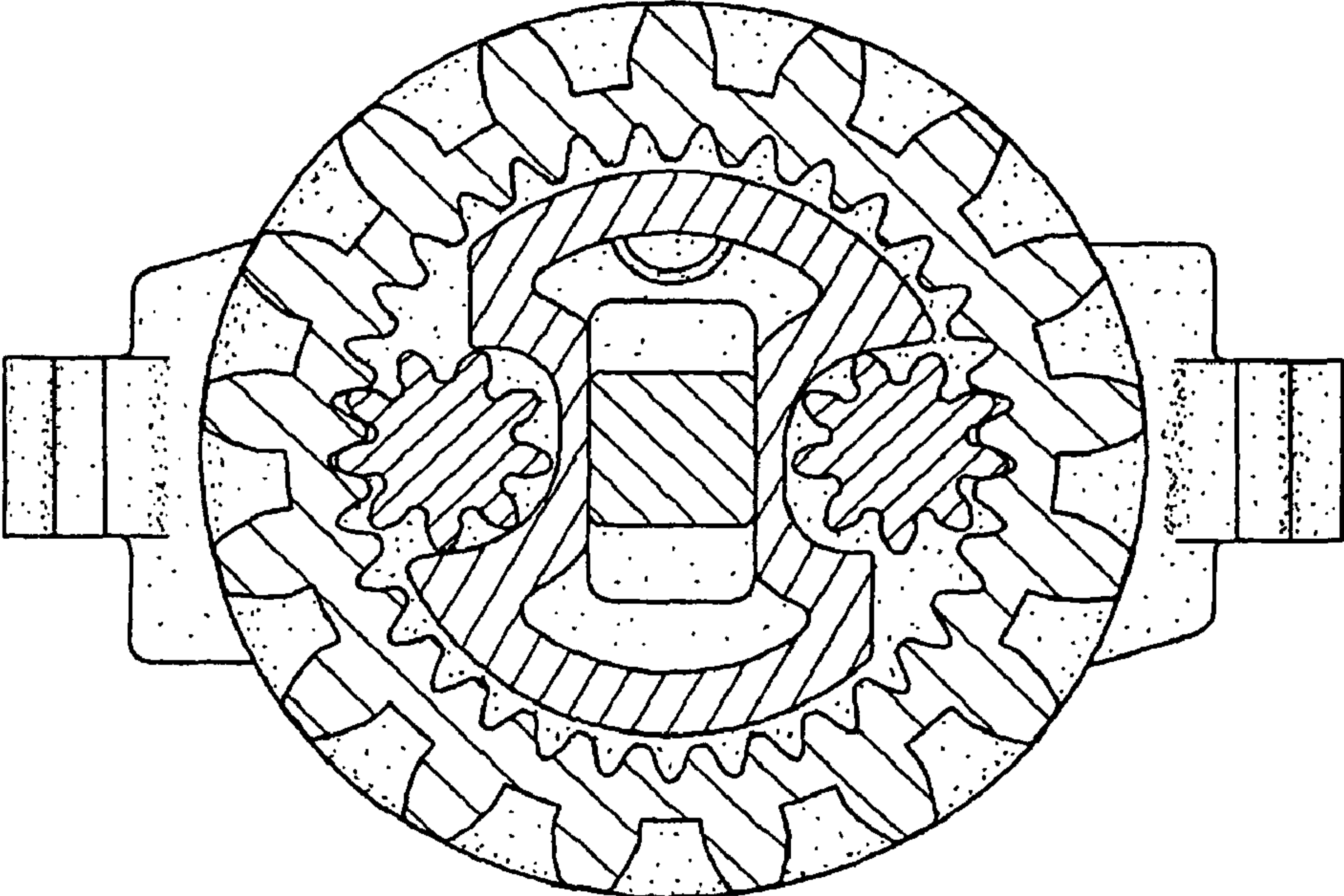

FIG. 9

