



US00D670261S

(12) **United States Design Patent**
Nuovo et al.

(10) **Patent No.:** **US D670,261 S**

(45) **Date of Patent:** **** Nov. 6, 2012**

(54) **HANDSET**

(75) Inventors: **Frank Nuovo**, Los Angeles, CA (US);
Eduardo Salazar, Reseda, CA (US)

(73) Assignee: **Nokia Corporation**, Espoo (FI)

(**) Term: **14 Years**

(21) Appl. No.: **29/406,512**

(22) Filed: **Nov. 15, 2011**

Related U.S. Application Data

(63) Continuation of application No. 29/396,292, filed on Jun. 28, 2011, now Pat. No. Des. 657,765.

(51) **LOC (9) Cl.** **14-03**

(52) **U.S. Cl.** **D14/138 G**

(58) **Field of Classification Search** D14/138 R,
D14/138 AD, 138 AC, 138 C, 138 G, 191,
D14/203.1–203.8, 496, 138 AA, 138 AB,
D14/137, 147, 218, 341–347, 247–248; D10/65,
D10/78, 104; D13/168; D18/7; 455/566,
455/575.1, 575.3, 575.4

See application file for complete search history.

(56) **References Cited**

U.S. PATENT DOCUMENTS

D465,774 S	11/2002	Nuovo
D499,709 S	12/2004	Nuovo et al.
D503,170 S	3/2005	Leviel et al.
D511,773 S	11/2005	Horiki et al.
D512,393 S	12/2005	Lee et al.
D521,485 S	5/2006	Tyneski et al.
D526,298 S	8/2006	Kota et al.
D527,717 S	9/2006	Kim
D546,798 S	7/2007	Kim et al.
D548,712 S	8/2007	Kim et al.
D554,097 S	10/2007	Lee
D560,193 S	1/2008	Sung et al.
7,330,743 B2	2/2008	Hutchinson et al.
D568,849 S	5/2008	Nuovo
D585,411 S	1/2009	Eaton
D597,537 S	8/2009	Eaton

D602,456 S	10/2009	Aithal et al.
D605,618 S	12/2009	Nuovo et al.
D606,038 S	12/2009	Aarras
D608,319 S	1/2010	Nuovo
D616,856 S	6/2010	Song et al.
D617,755 S	6/2010	Leinvuo
D618,655 S	6/2010	Sandberg
D620,467 S	7/2010	Aarras
D625,700 S	10/2010	Sandberg et al.
D627,756 S	11/2010	Nuovo

(Continued)

FOREIGN PATENT DOCUMENTS

JP 1369463 9/2001

(Continued)

OTHER PUBLICATIONS

Vertu Constellation, announced Oct. 2011, [online], [retrieved on Oct. 27, 2011]. Retrieved from Internet ,<URL: <http://www.gsmarena.com>>.*

(Continued)

Primary Examiner — Bridget L Eland

(74) *Attorney, Agent, or Firm* — Banner & Witcoff, Ltd.

(57) **CLAIM**

The ornamental design for a handset, as shown and described.

DESCRIPTION

FIG. 1 is a perspective view of a handset showing our new design;

FIG. 2 is a front view thereof;

FIG. 3 is a rear view thereof;

FIG. 4 is a left side view thereof;

FIG. 5 is a right side view thereof;

FIG. 6 is a top view thereof; and,

FIG. 7 is a bottom view thereof.

The broken lines immediately adjacent the shaded areas represent the bounds of the claimed design; the broken lines form no part of the claimed design.

1 Claim, 5 Drawing Sheets

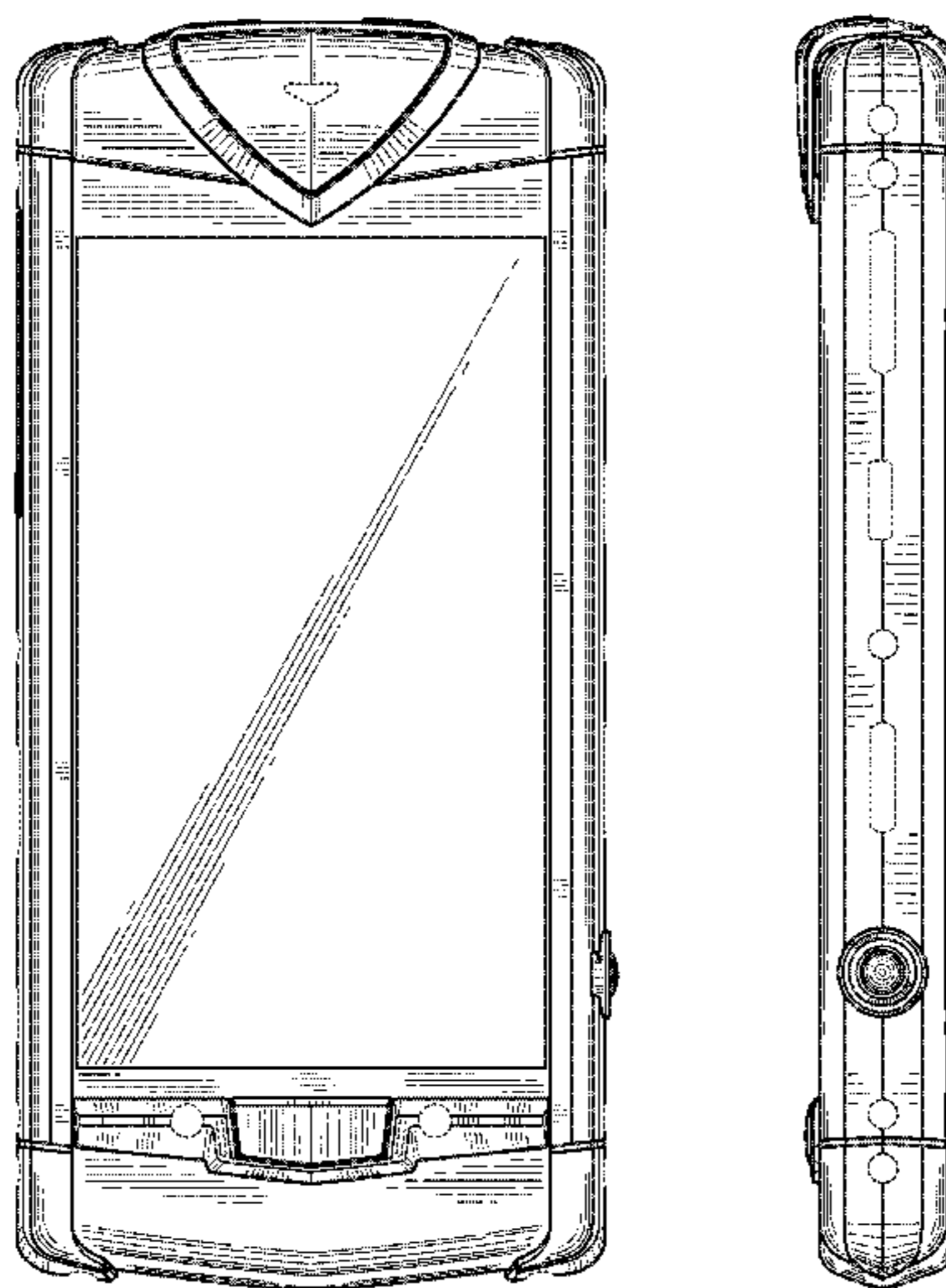

US D670,261 S

Page 2

U.S. PATENT DOCUMENTS

D628,552 S 12/2010 Nuovo et al.
D629,377 S 12/2010 Ivaskevicius
D629,784 S 12/2010 Forsyth
D633,888 S 3/2011 Eguchi
D634,290 S 3/2011 Landwehr
D634,294 S 3/2011 Dhondt
D635,954 S 4/2011 Aarras
D635,967 S 4/2011 Montin et al.
D636,364 S 4/2011 Sandberg
D637,992 S 5/2011 Tom et al.
D639,770 S 6/2011 Choi
D640,222 S 6/2011 Dearsley
D640,225 S 6/2011 Choi
D645,442 S 9/2011 Landwehr
D645,460 S 9/2011 Nuovo et al.
D646,256 S 10/2011 Kim
D653,246 S * 1/2012 Salazar et al. D14/248
D654,067 S * 2/2012 Salazar et al. D14/248
D654,465 S * 2/2012 Salazar et al. D14/138 G

D654,480 S * 2/2012 Salazar et al. D14/247
D657,765 S * 4/2012 Salazar et al. D14/138 G
2006/0166713 A1 7/2006 Yeh et al.
2006/0211460 A1 9/2006 Jeong et al.

FOREIGN PATENT DOCUMENTS

JP 1373284 11/2009
TW 139283 3/2011
TW 143379 10/2011

OTHER PUBLICATIONS

Gigabyte g-Smart, announced 2005, [online], [retrieved on Feb. 20, 2007]. Retrieved from Internet, <URL: <http://www.gsmarena.com>>.
HTC P6500, announced Oct. 2007, [online], [retrieved on Dec. 13, 2007]. Retrieved from Internet, <URL: <http://www.gsmarena.com>>.
Taiwanese Office Action, Application No. 100305104, 4 pages, issued May 7, 2012.

* cited by examiner

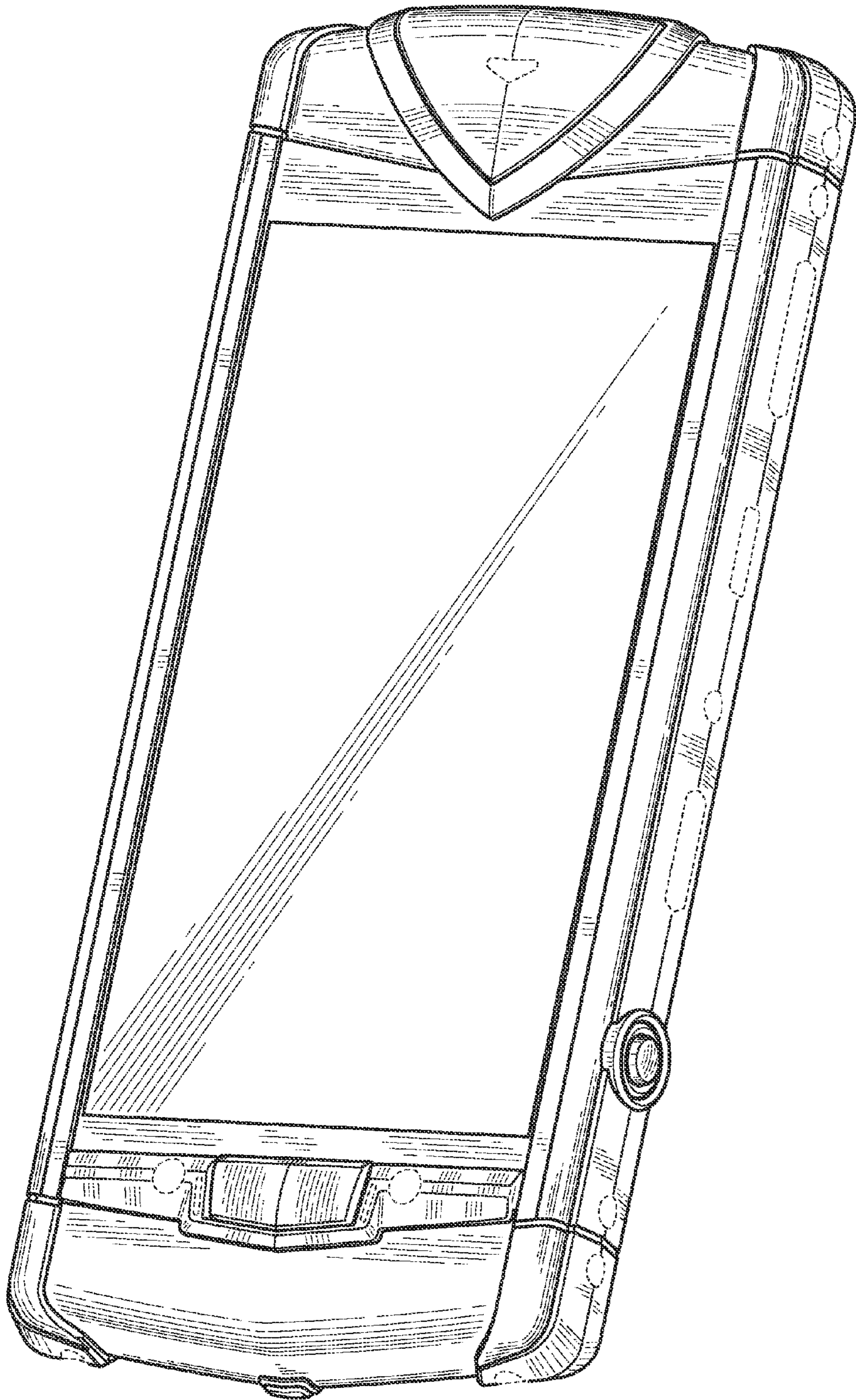

FIG. 1

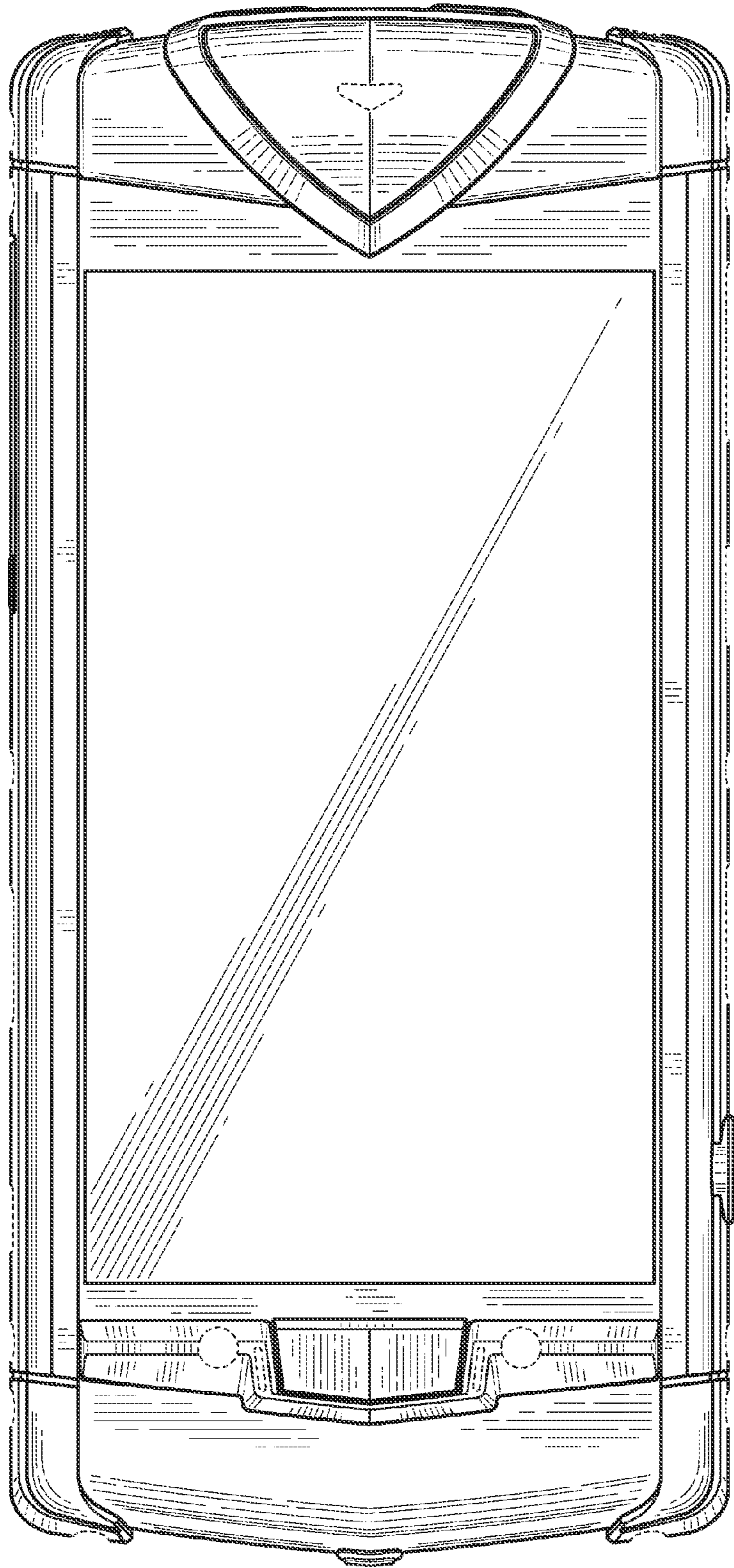

FIG. 2

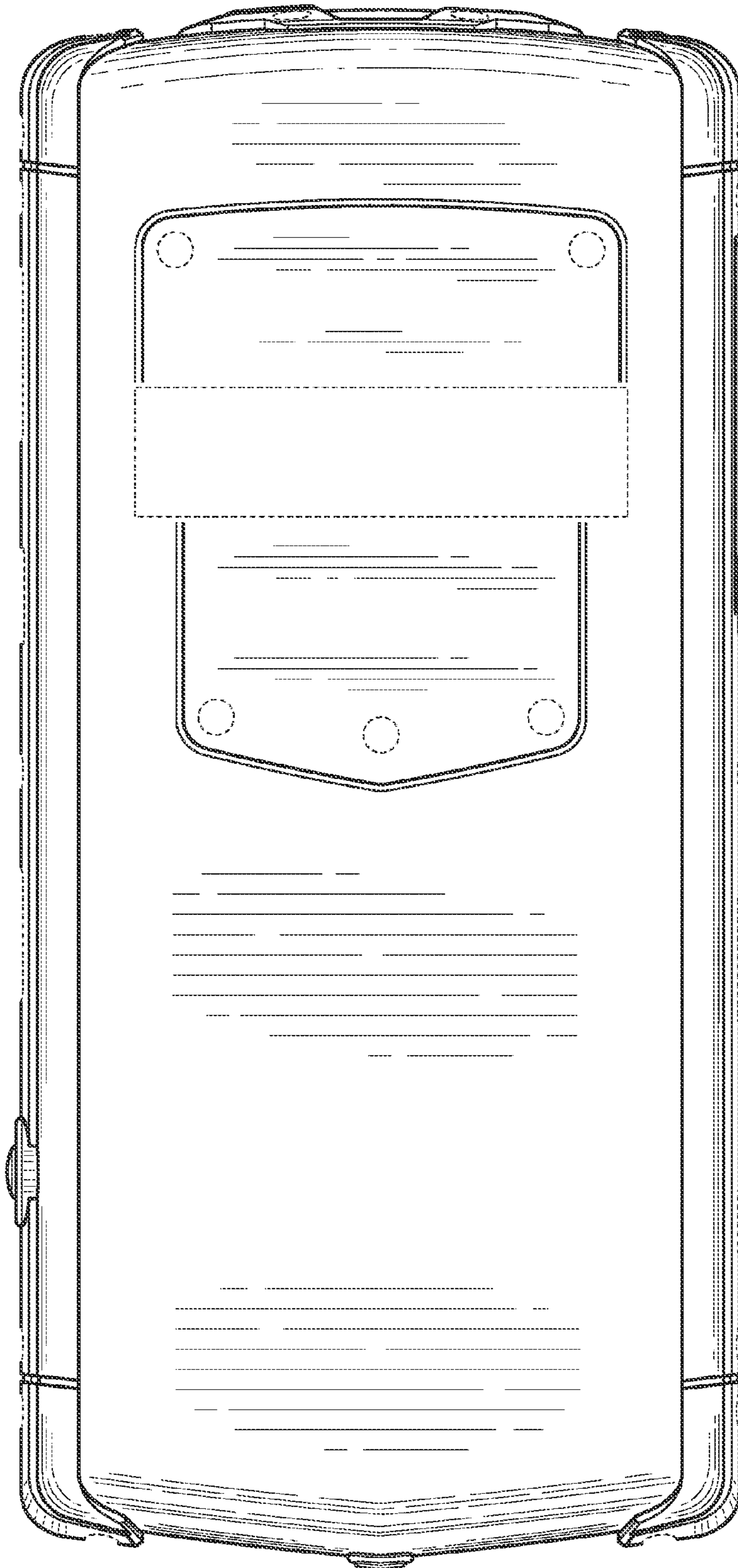

FIG. 3

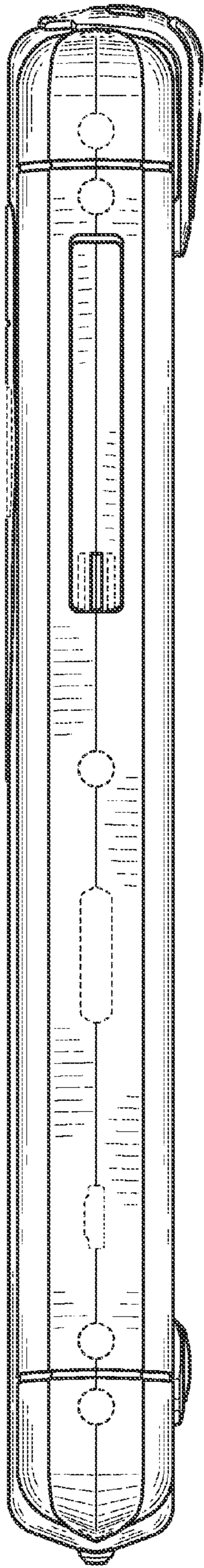

FIG. 4

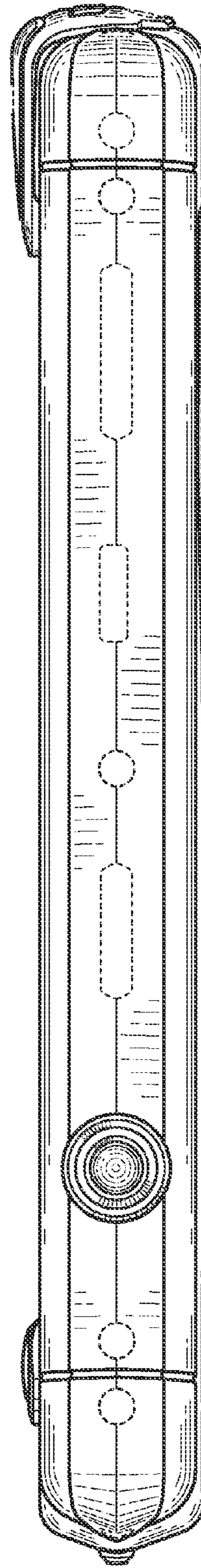

FIG. 5

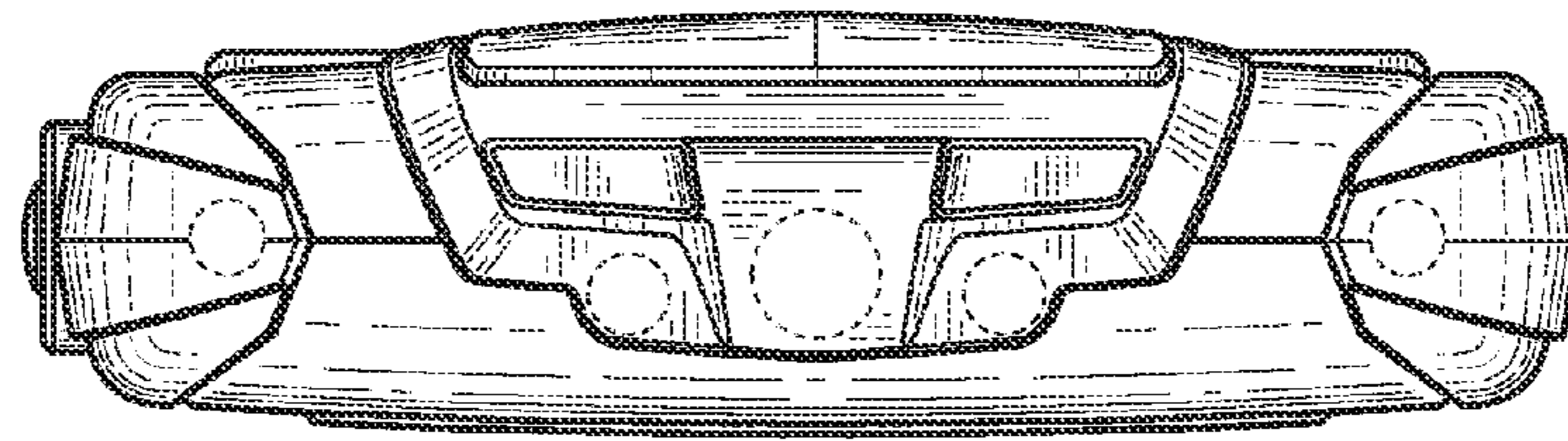

FIG. 6

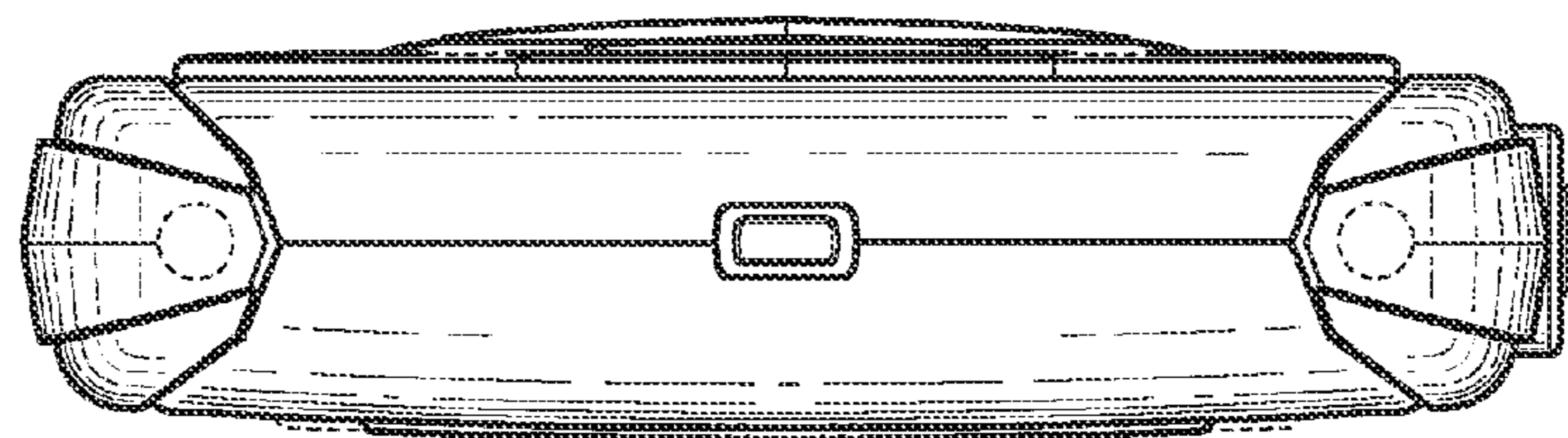

FIG. 7