



US00D670189S

(12) **United States Design Patent**  
**Puglisi et al.**

(10) **Patent No.:** **US D670,189 S**

(45) **Date of Patent:** **\*\* Nov. 6, 2012**

(54) **ROUND ERASER BRACELET**

(75) Inventors: **Marc Puglisi**, Wayne, NJ (US); **Scott Kennis**, Montvale, NJ (US)

(73) Assignee: **Marc Puglisi**, Wayne, NJ (US)

(\*\*) Term: **14 Years**

(21) Appl. No.: **29/411,572**

(22) Filed: **Jan. 24, 2012**

(51) **LOC (9) Cl.** ..... **11-01**

(52) **U.S. Cl.** ..... **D11/3; D11/26**

(58) **Field of Classification Search** ..... D11/1-39;  
63/3, 3.1, 3.2, 5, 15.1-15.4, 15.45, 15.5,  
63/15.6, 15.65, 15.7, 26-28; D10/30, 31,  
D10/32

See application file for complete search history.

(56) **References Cited**

U.S. PATENT DOCUMENTS

450,378	A *	4/1891	Ronbinson	.....	451/461
3,835,664	A *	9/1974	Nesbit	.....	63/15.6
3,949,754	A *	4/1976	Ferro	.....	D11/42
5,074,127	A *	12/1991	Yurman	.....	63/3
D371,314	S *	7/1996	Yurman	.....	D11/3
D491,832	S *	6/2004	Gordon	.....	D11/26
D496,591	S *	9/2004	Yurman	.....	D10/32
D534,828	S *	1/2007	Woodyard	.....	D11/35
D575,658	S *	8/2008	Lee	.....	D11/4

D593,431	S *	6/2009	Komenaka	.....	D11/26
D605,069	S *	12/2009	Plouchard	.....	D11/3
D662,437	S *	6/2012	Verdeille	.....	D11/34

\* cited by examiner

*Primary Examiner* — Cathron Brooks

*Assistant Examiner* — Melanie Pellegrini

(74) *Attorney, Agent, or Firm* — Myers Wolin, LLC; Scott H. Kaliko

(57) **CLAIM**

An ornamental design for a round eraser bracelet, as shown and described.

**DESCRIPTION**

FIG. 1 is a top front view of an embodiment of the present invention;

FIG. 2 is a front view of an embodiment of the present invention;

FIG. 3 is a rear view of an embodiment of the present invention;

FIG. 4 is a right side view of an embodiment of the present invention;

FIG. 5 is a left side view of an embodiment of the present invention;

FIG. 6 is a top view of an embodiment of the present invention; and,

FIG. 7 is a bottom side view of an embodiment of the present invention.

**1 Claim, 2 Drawing Sheets**

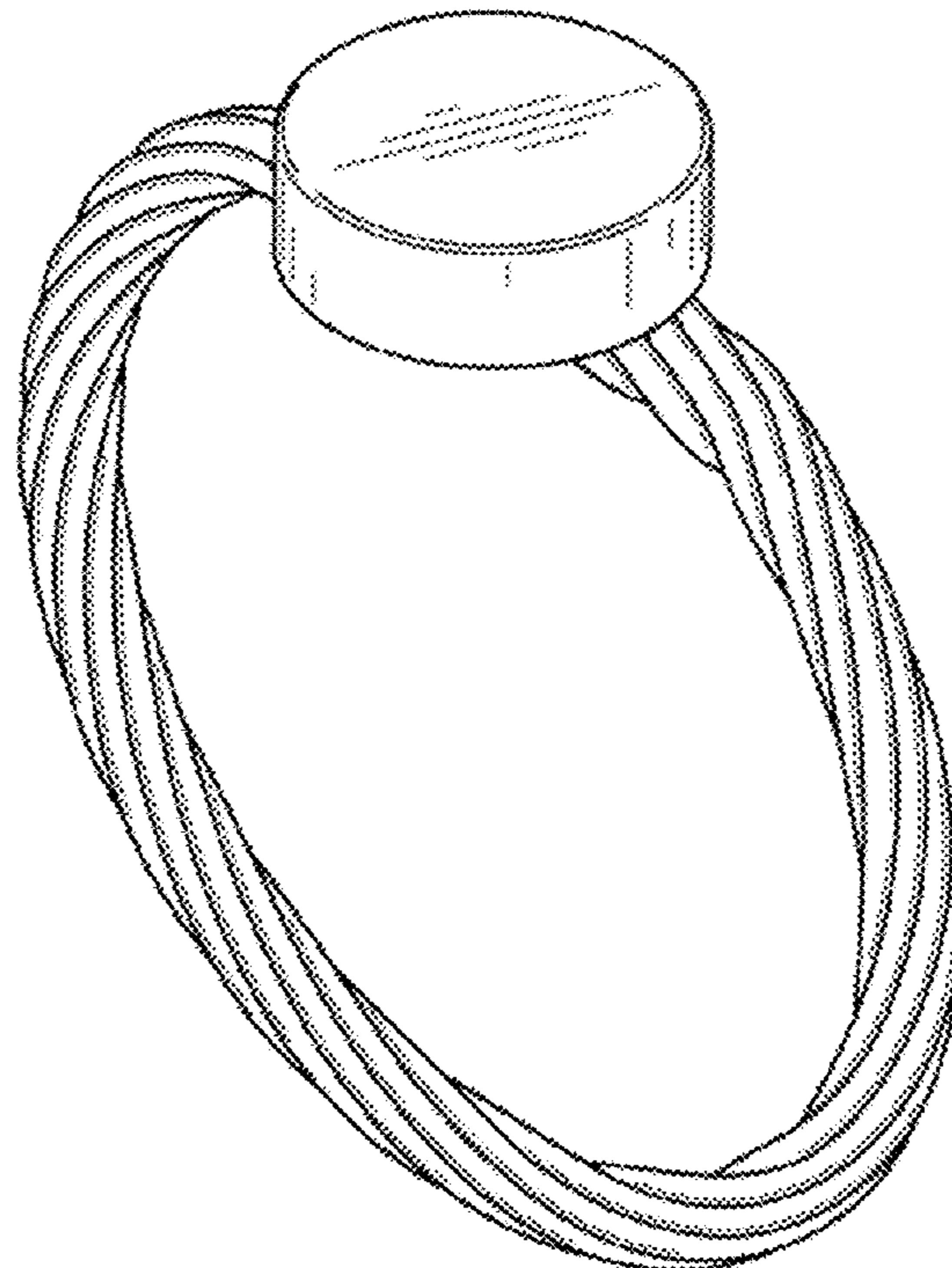

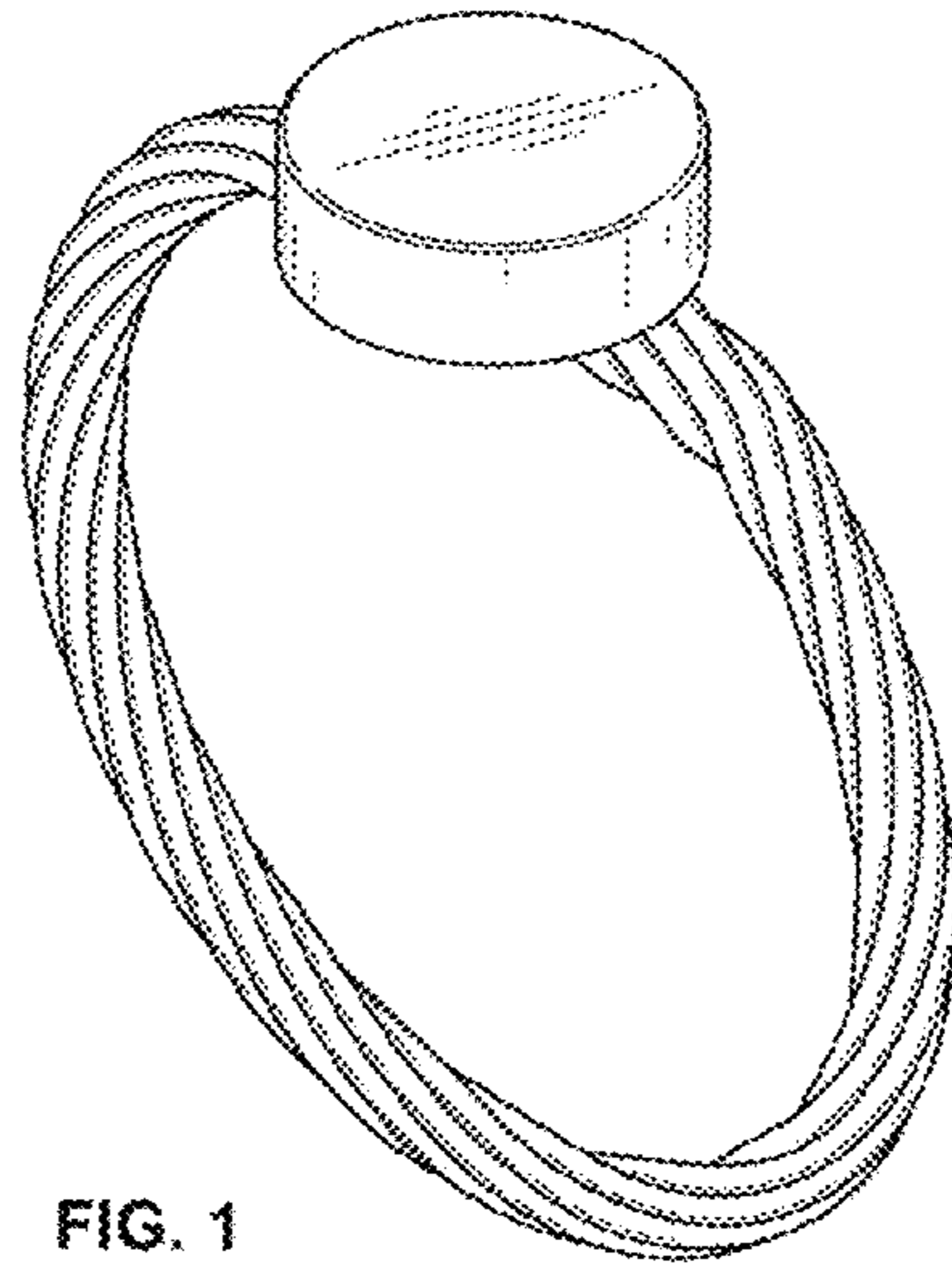

FIG. 1

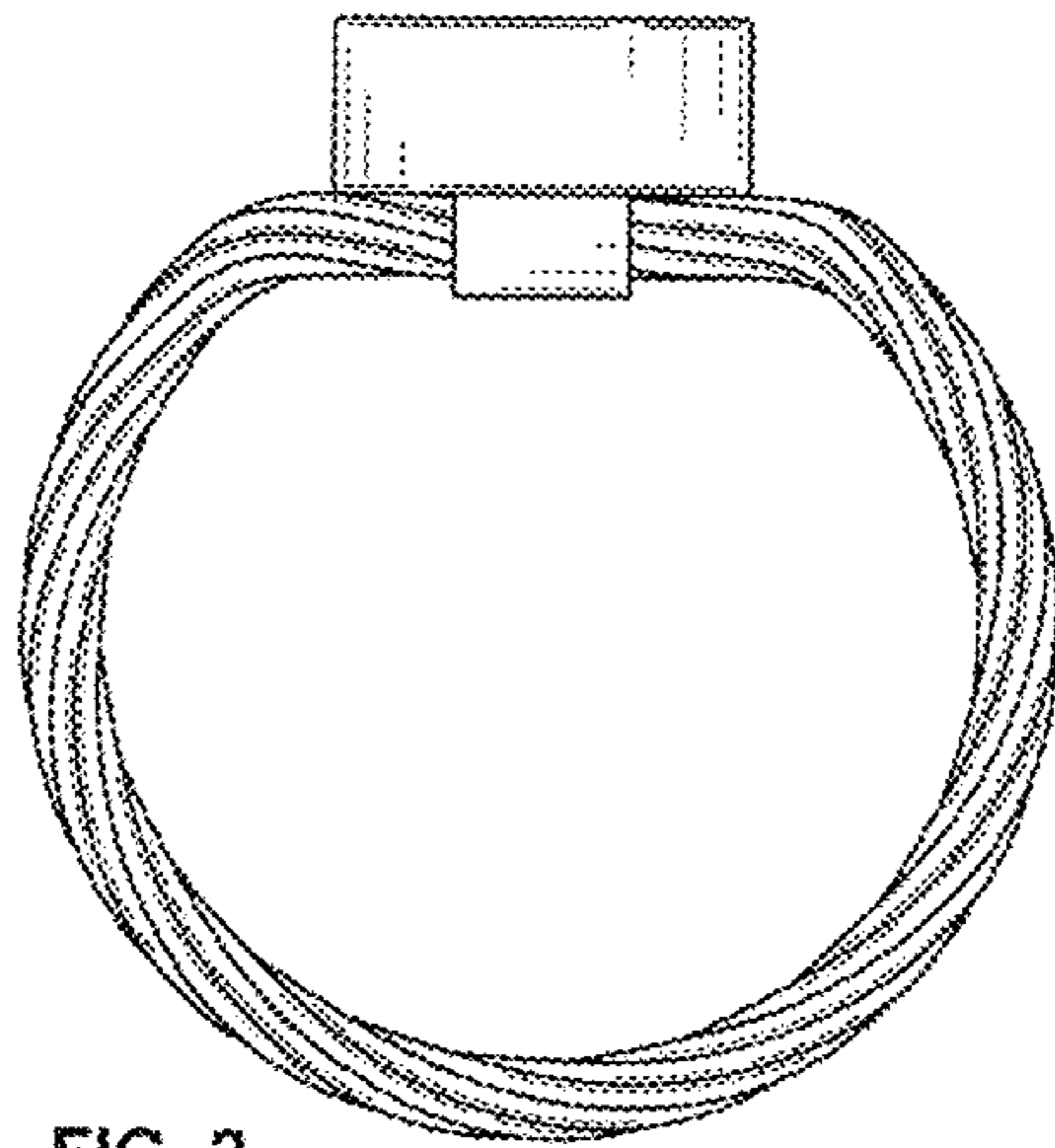

FIG. 2

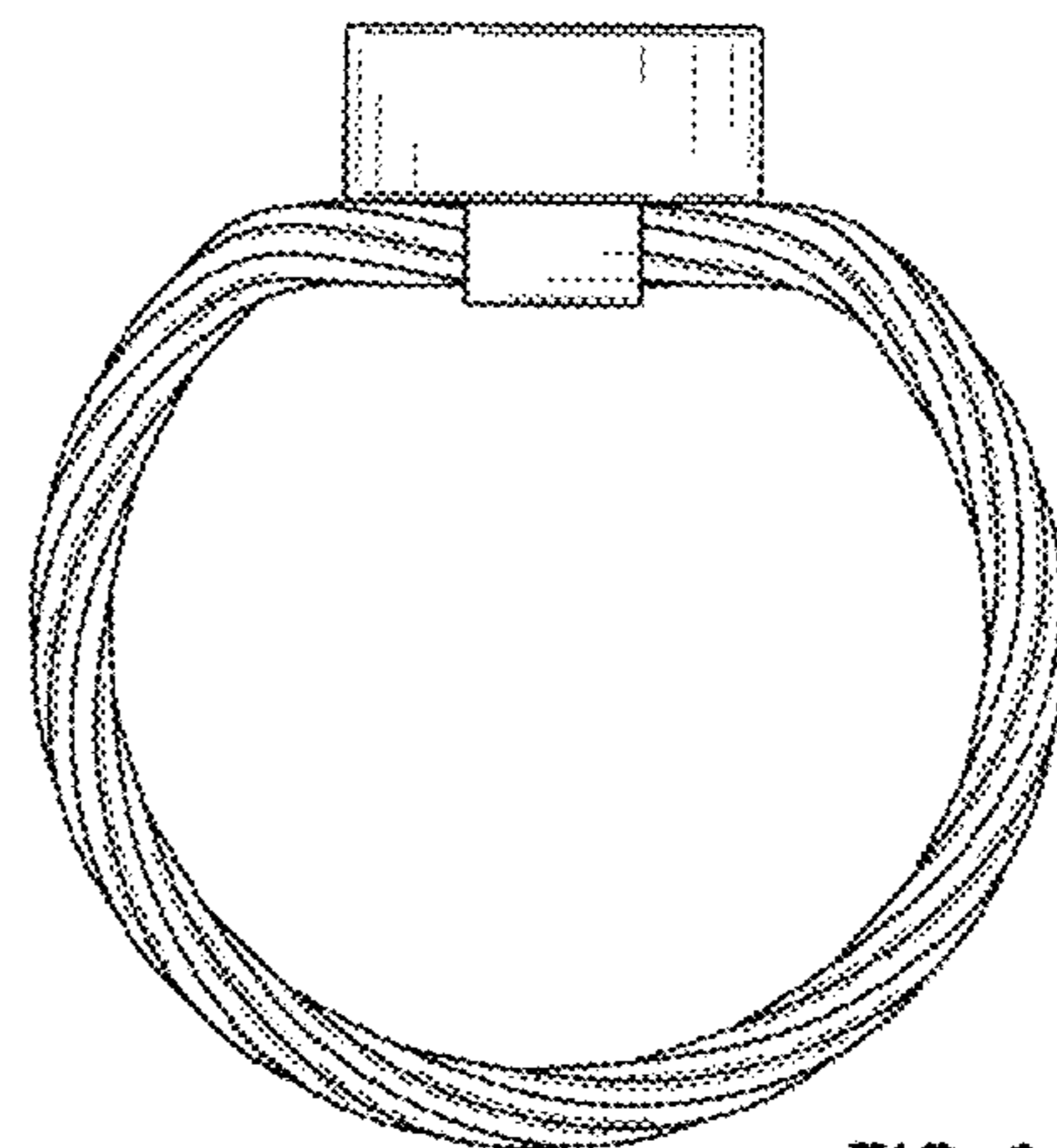

FIG. 3

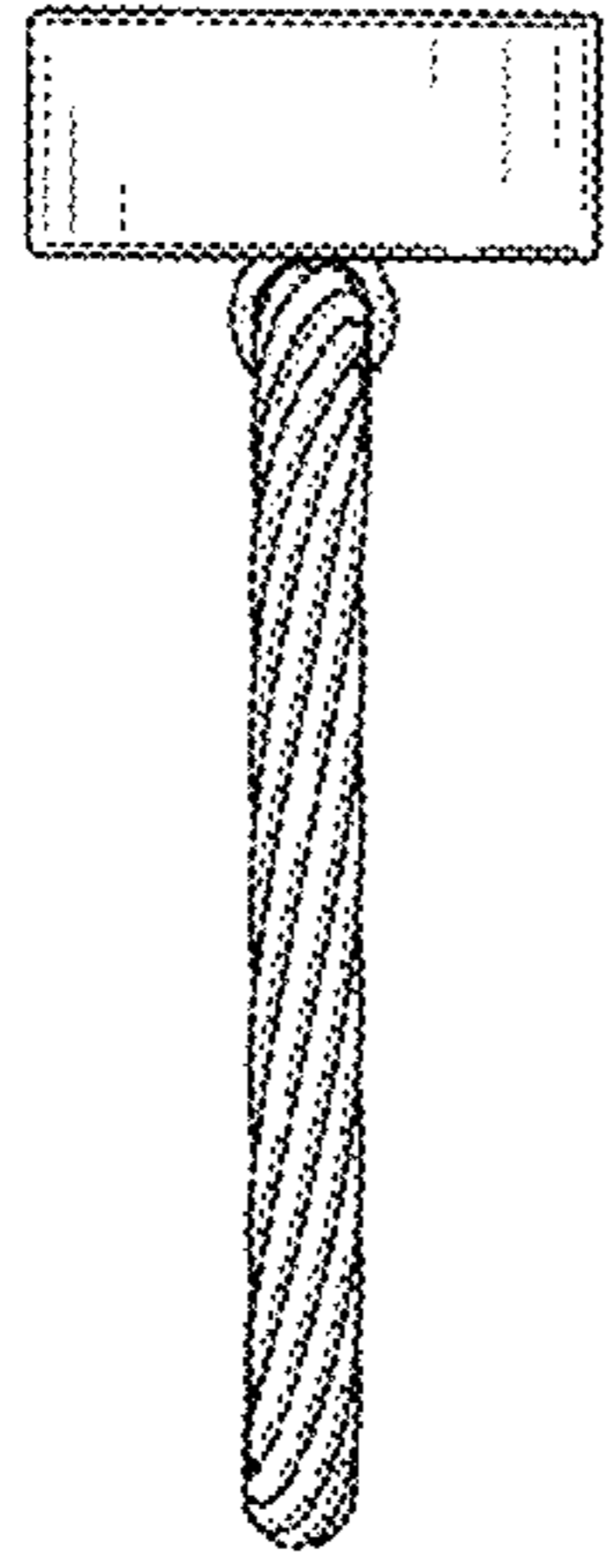

FIG. 4

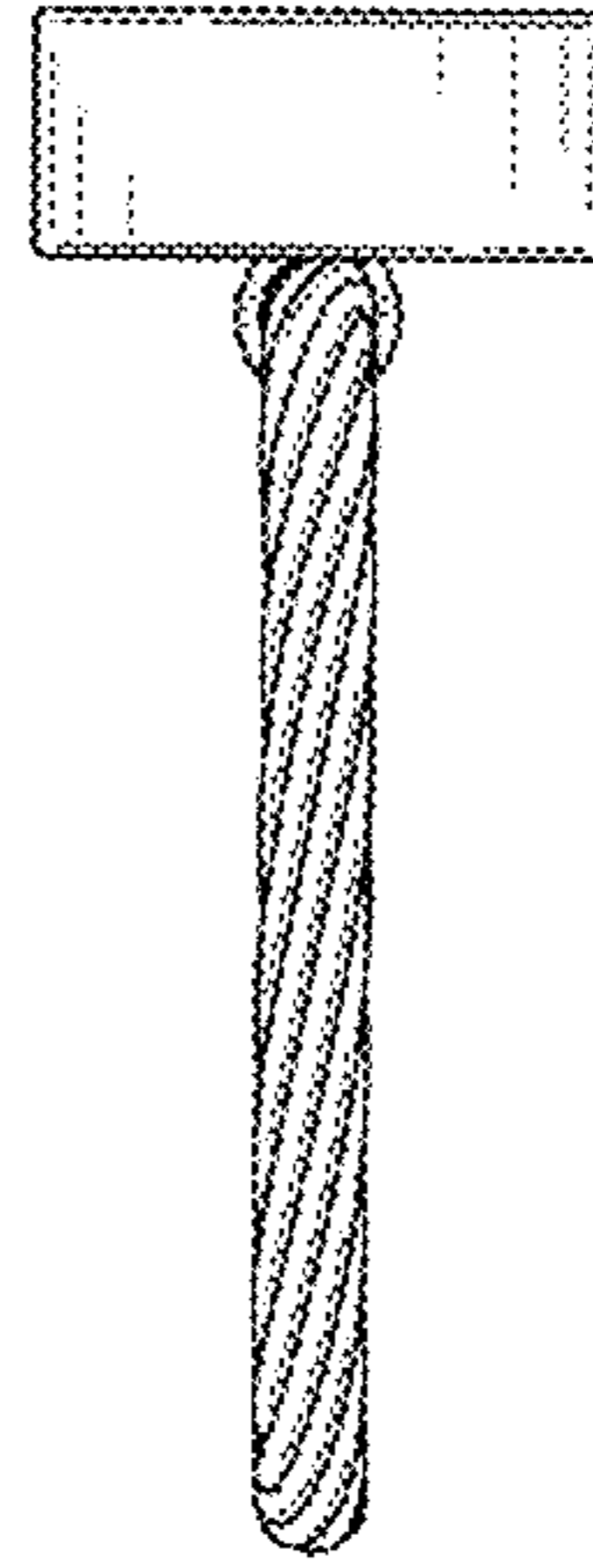

FIG. 5

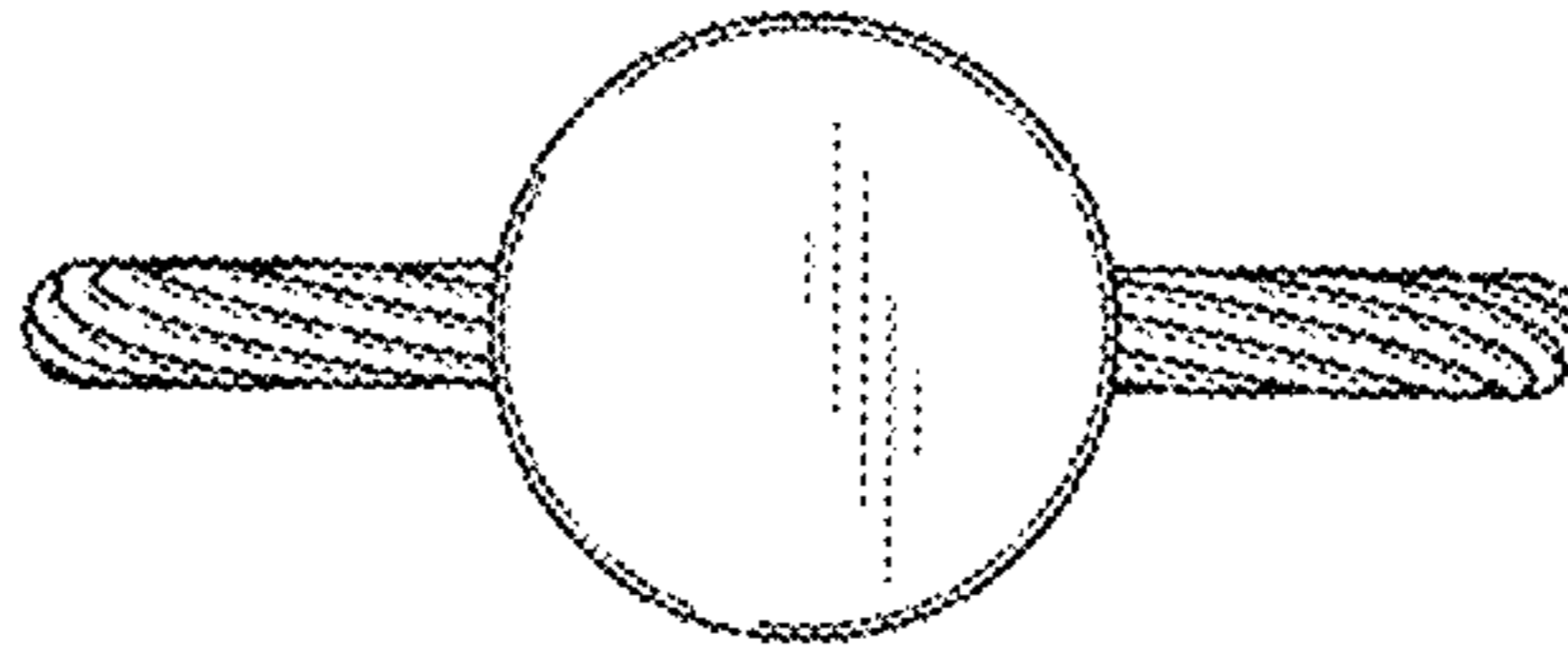

FIG. 6

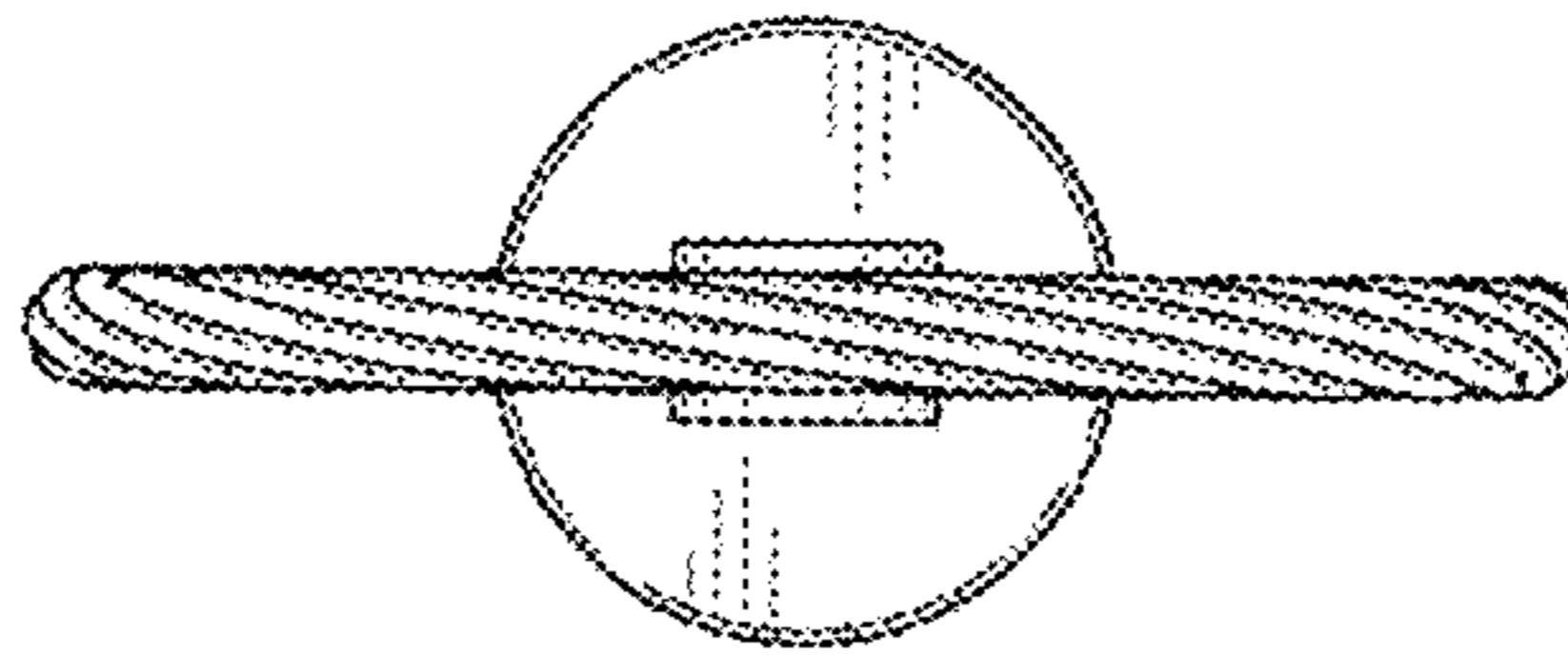

FIG. 7