



US00D670184S

(12) **United States Design Patent**  
**Pobocha et al.**

(10) **Patent No.:** **US D670,184 S**  
(45) **Date of Patent:** **\*\* Nov. 6, 2012**

(54) **WEIGHING SCALE BODY**

(75) Inventors: **Zbigniew Pobocha**, Brookside, NJ (US);  
**Neil Olesen**, Millington, NJ (US); **Jose**  
**A. Giron**, West Orange, NJ (US);  
**Michael Albon**, Madison, NJ (US);  
**Richard McAllister O’Grady**,  
Southington, CT (US)

(73) Assignee: **Ohaus Corporation**, Parsippany, NJ  
(US)

(\*\*) Term: **14 Years**

(21) Appl. No.: **29/396,750**

(22) Filed: **Jul. 6, 2011**

(51) **LOC (9) Cl.** ..... **10-04**

(52) **U.S. Cl.** ..... **D10/91**

(58) **Field of Classification Search** ..... D10/88-91;  
177/25.13-25.18, 177-182, 211-214, 210 R,  
177/210 C, 210 GM, 210 FP, 210 PP, 210 EM,  
177/148, 236-245, DIG. 3

See application file for complete search history.

(56) **References Cited**

U.S. PATENT DOCUMENTS

6,995,323 B2 \* 2/2006 Kunzi et al. .... 177/25.13

\* cited by examiner

*Primary Examiner* — Antoine D Davis

(74) *Attorney, Agent, or Firm* — Standley Law Group LLP

(57) **CLAIM**

The ornamental design for a weighing scale body, as shown and described above.

**DESCRIPTION**

FIG. 1 is a front-left perspective view of a first embodiment of a weighing scale body showing our new design;

FIG. 2 is a top plan view of the embodiment of FIG. 1;

FIG. 3 is a front elevation view of the embodiment of FIG. 1; FIG. 4 is a rear elevation view of the embodiment of FIG. 1; FIG. 5 is a left side elevation view of the embodiment of FIG. 1, the right-side elevation view being a mirror image thereof; FIG. 6 is a top plan view of the weighing scale body of FIG. 1 shown in conjunction with an unclaimed weigh pan of round shape;

FIG. 7 is a top plan view of the weighing scale body of FIG. 1 shown in conjunction with an unclaimed weigh pan of square shape;

FIG. 8 is a front-left perspective view of a second embodiment of a weighing scale body showing our new design;

FIG. 9 is a top plan view of the embodiment of FIG. 8;

FIG. 10 is a front elevation view of the embodiment of FIG. 8;

FIG. 11 is a rear elevation view of the embodiment of FIG. 8;

FIG. 12 is a left side elevation view of the embodiment of FIG. 8, the right-side elevation view being a mirror image thereof;

FIG. 13 is a top plan view of the weighing scale body of FIG. 8 shown in conjunction with an unclaimed weigh pan of round shape;

FIG. 14 is a top plan view of the weighing scale body of FIG. 8 shown in conjunction with an unclaimed weigh pan of square shape;

FIG. 15 is a front-left perspective view of a third embodiment of a weighing scale body showing our new design;

FIG. 16 is a top plan view of the embodiment of FIG. 15;

FIG. 17 is a front elevation view of the embodiment of FIG. 15;

FIG. 18 is a rear elevation view of the embodiment of FIG. 15;

FIG. 19 is a left side elevation view of the embodiment of FIG. 15, the right-side elevation view being a mirror image thereof;

FIG. 20 is a top plan view of the weighing scale body of FIG. 15 shown in conjunction with an unclaimed weigh pan of round shape; and,

FIG. 21 is a top plan view of the weighing scale body of FIG. 15 shown in conjunction with an unclaimed weigh pan of square shape.

The bottom of the weighing scale body forms no part of the claimed design.

The broken line portions of the drawing figures are included to show unclaimed subject matter only and form no part of the claimed design.

**1 Claim, 15 Drawing Sheets**

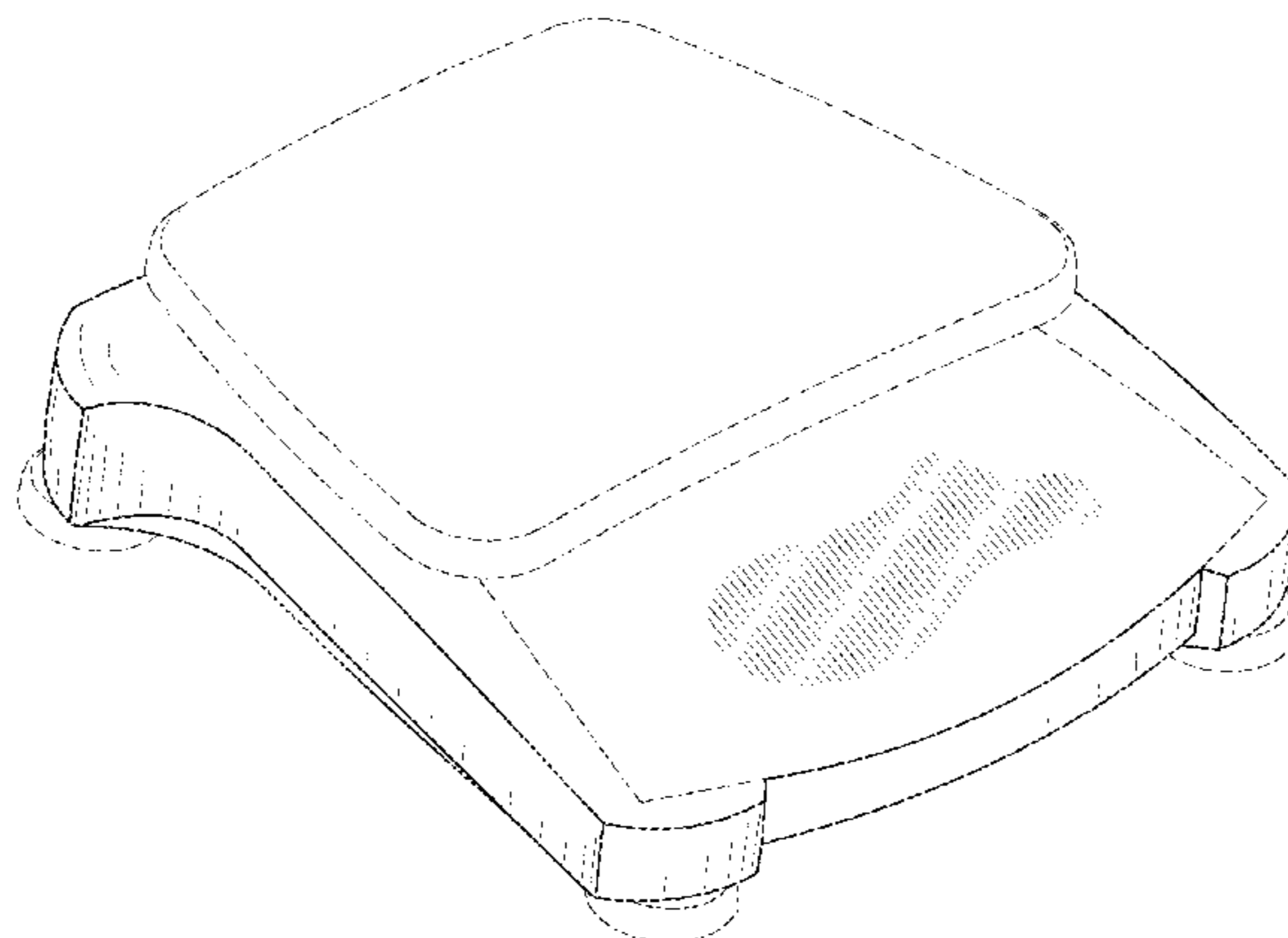

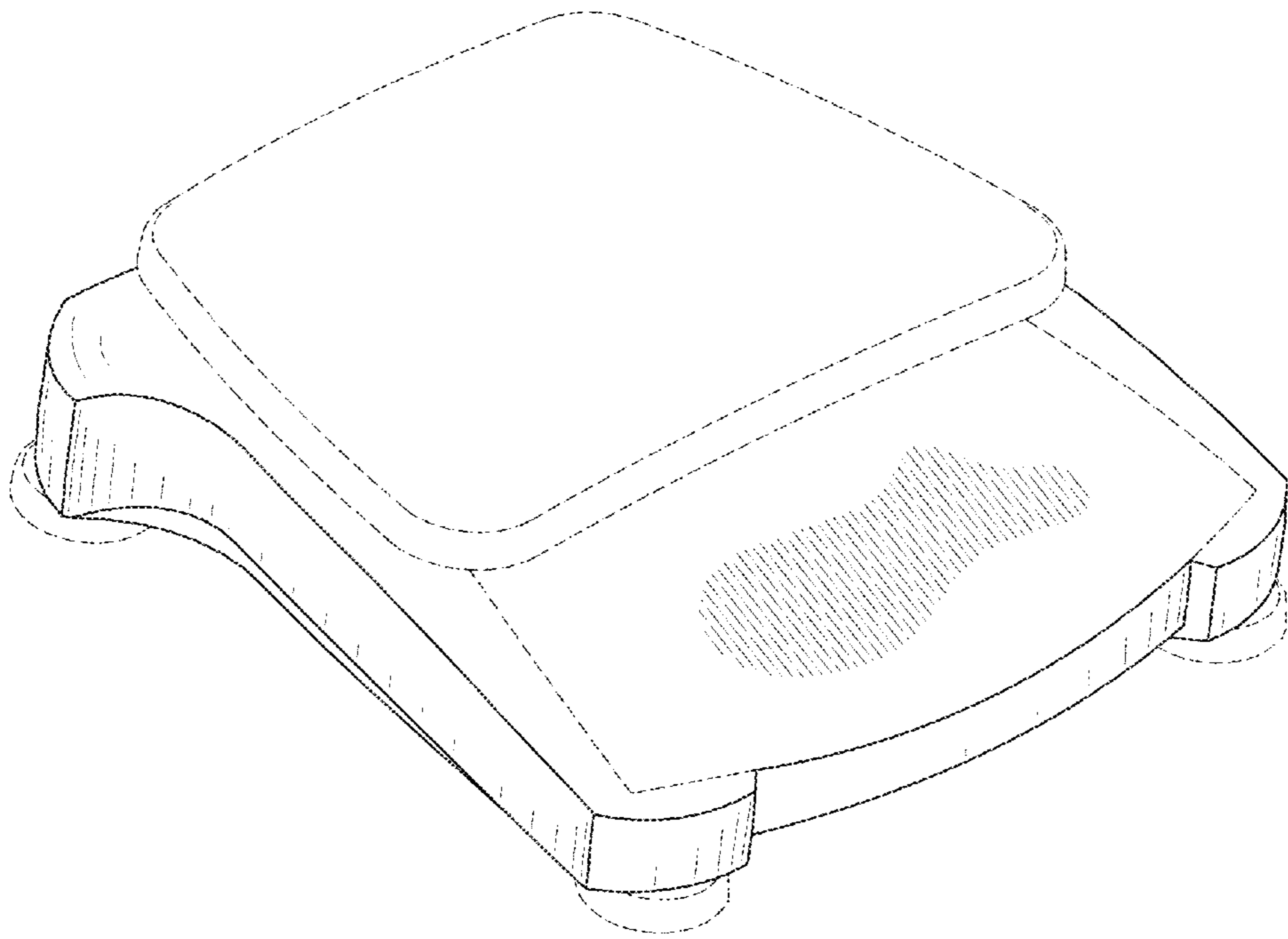

FIG-1

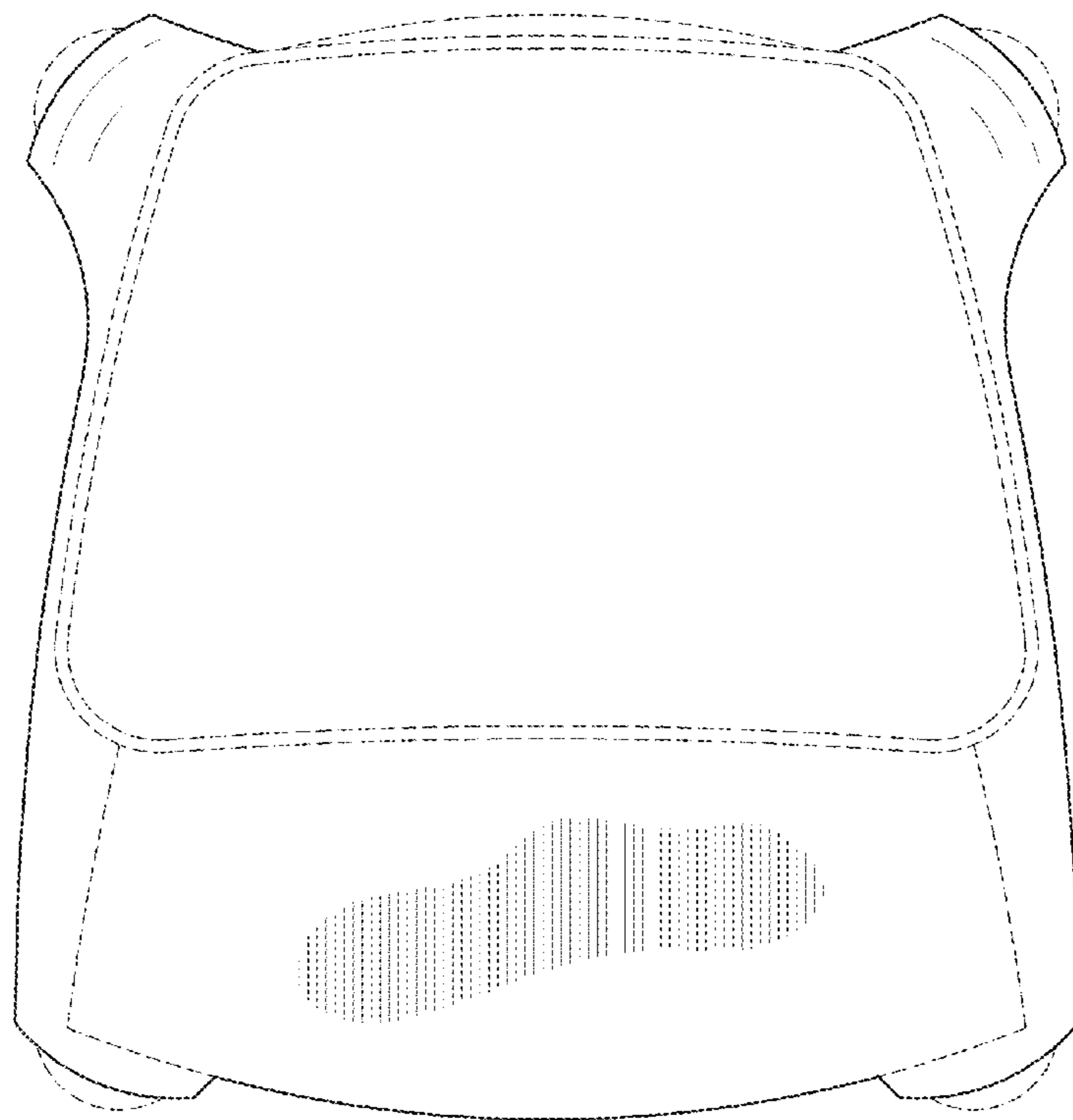

FIG-2

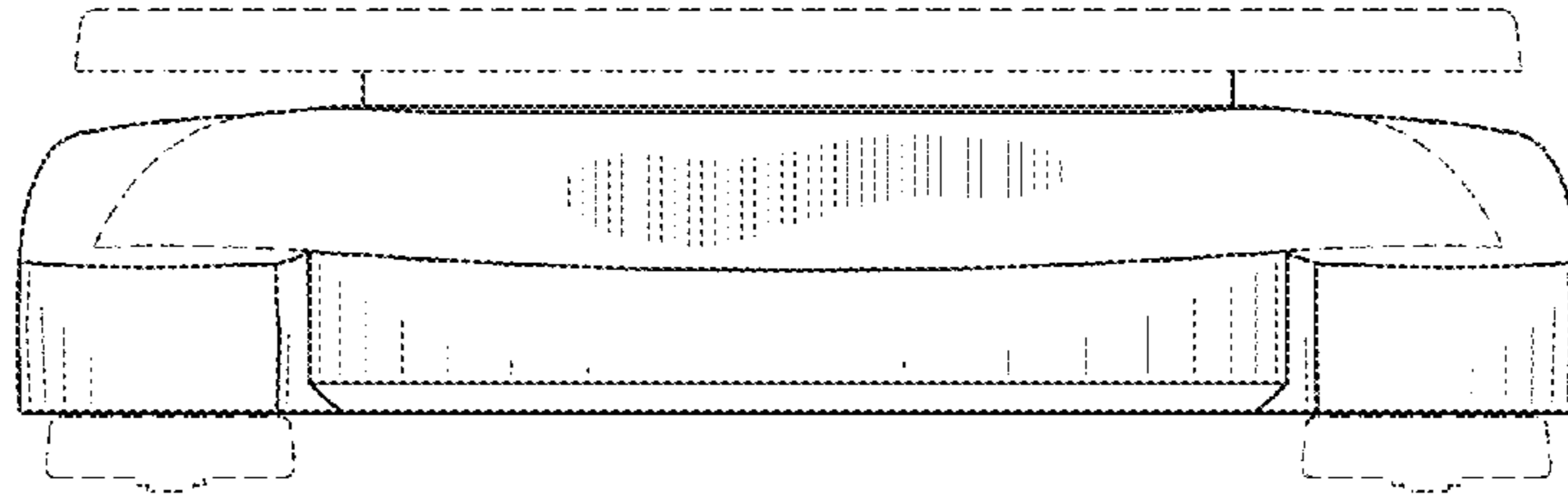

FIG-3

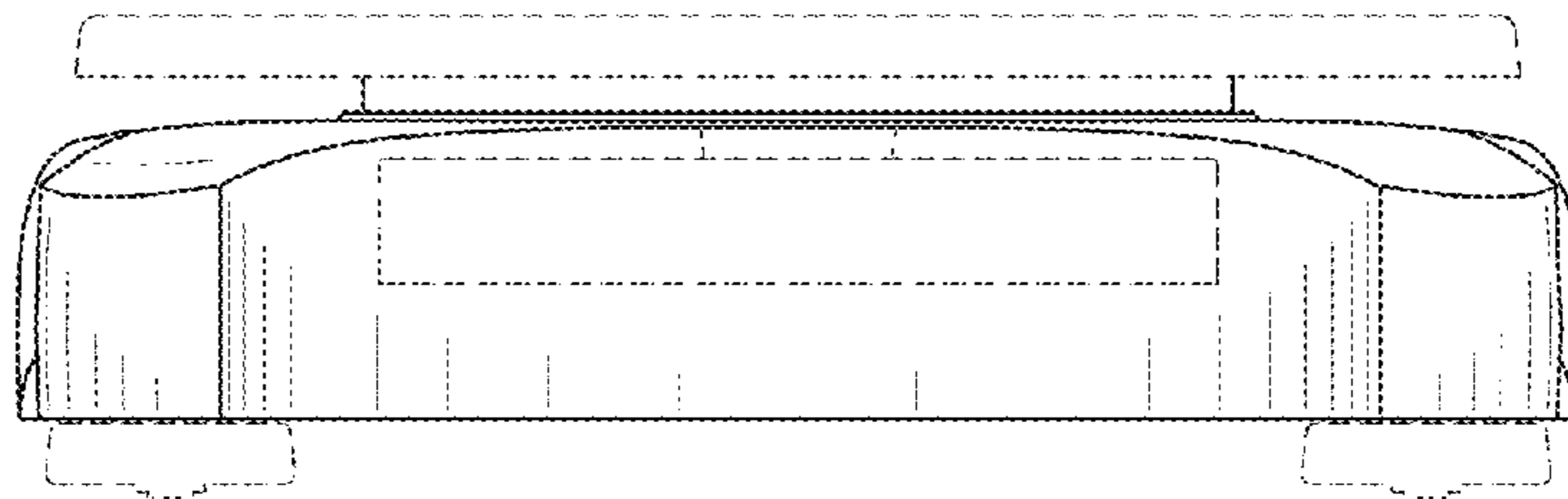

FIG-4

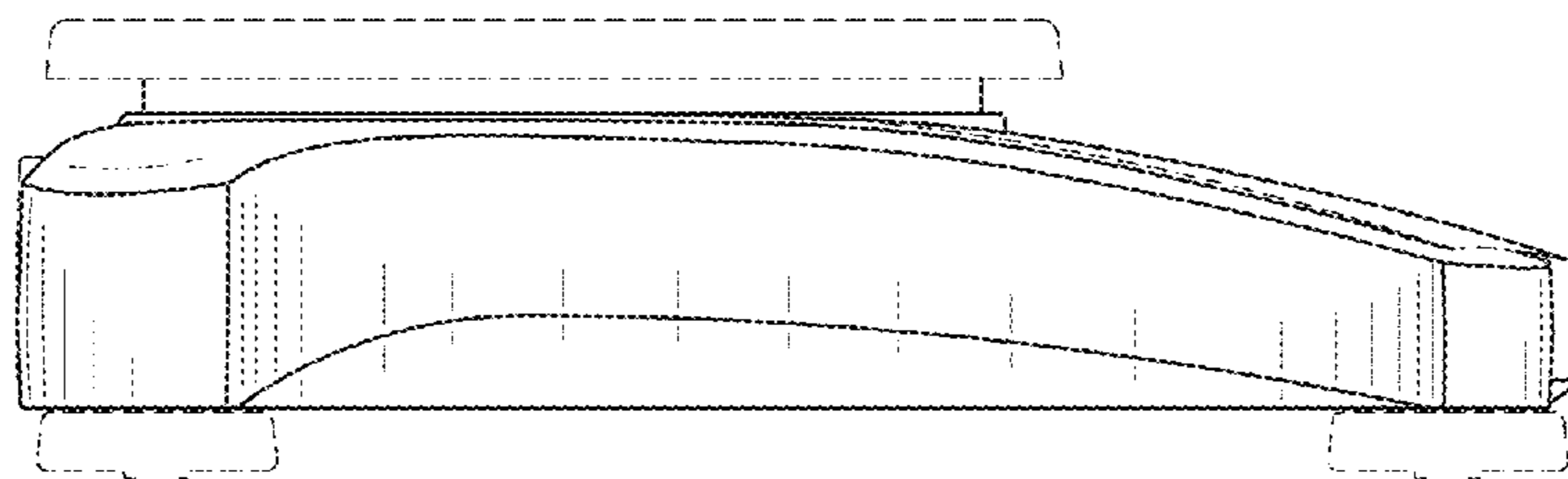

FIG-5

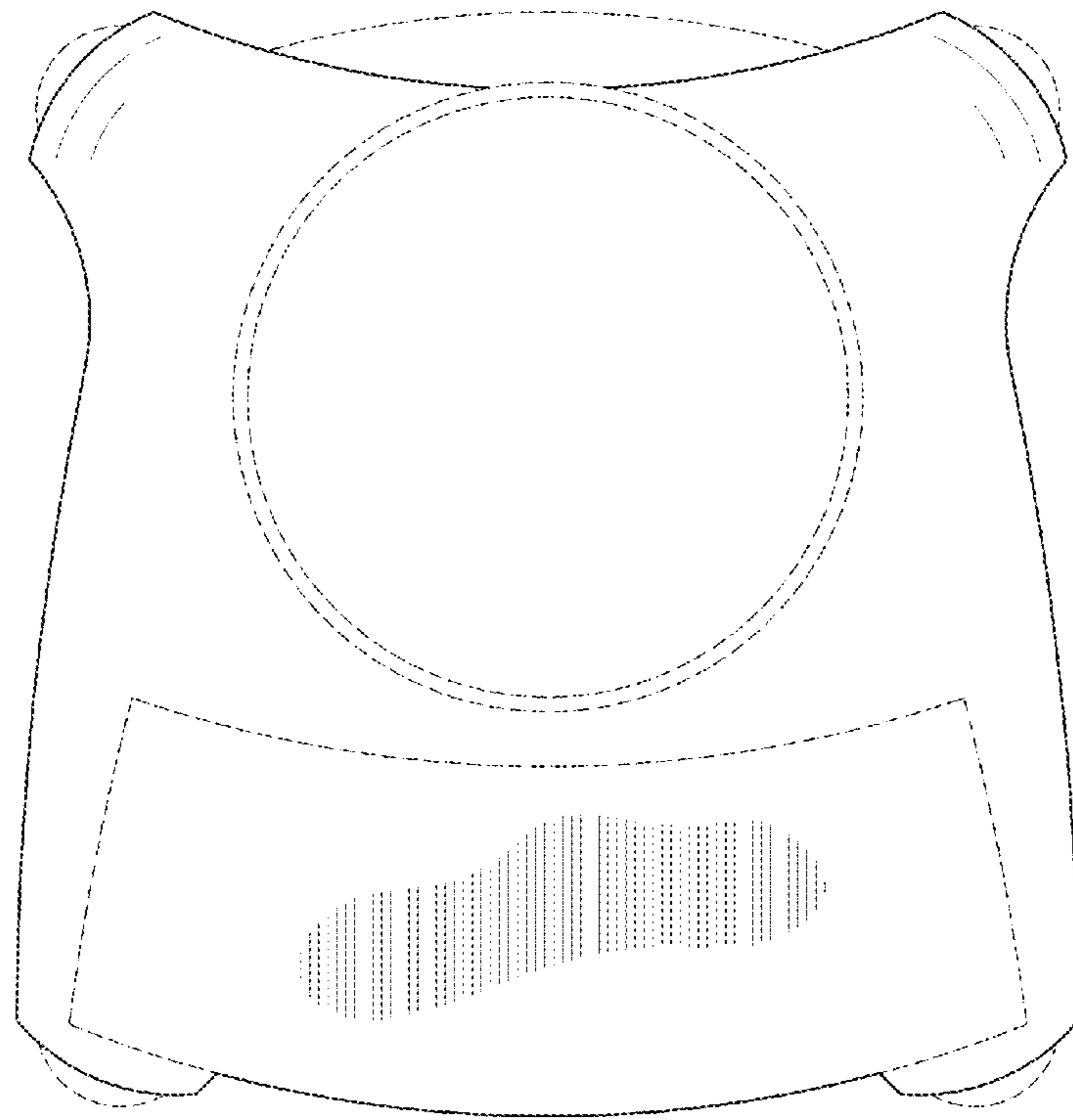

FIG-6

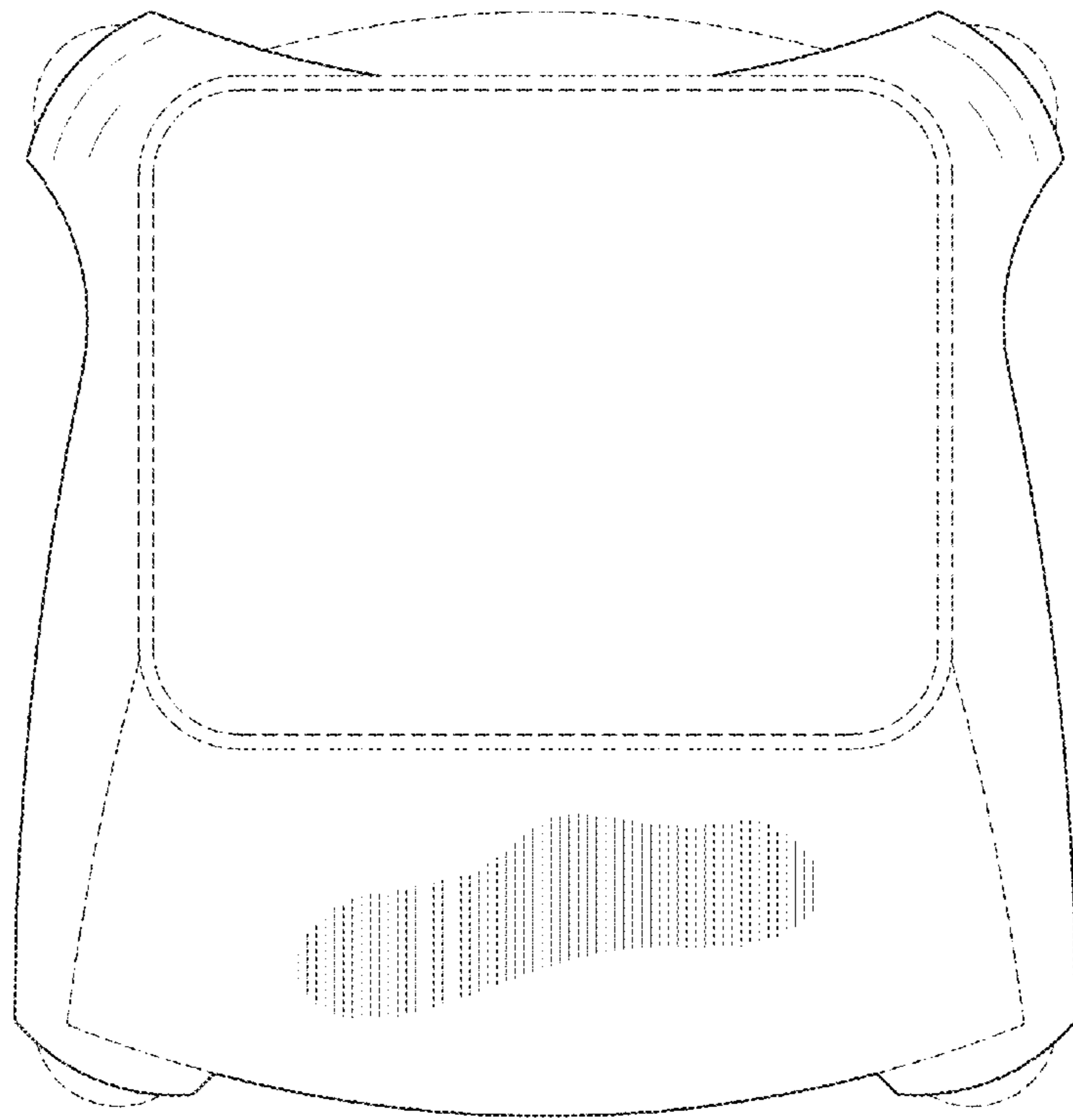

FIG-7



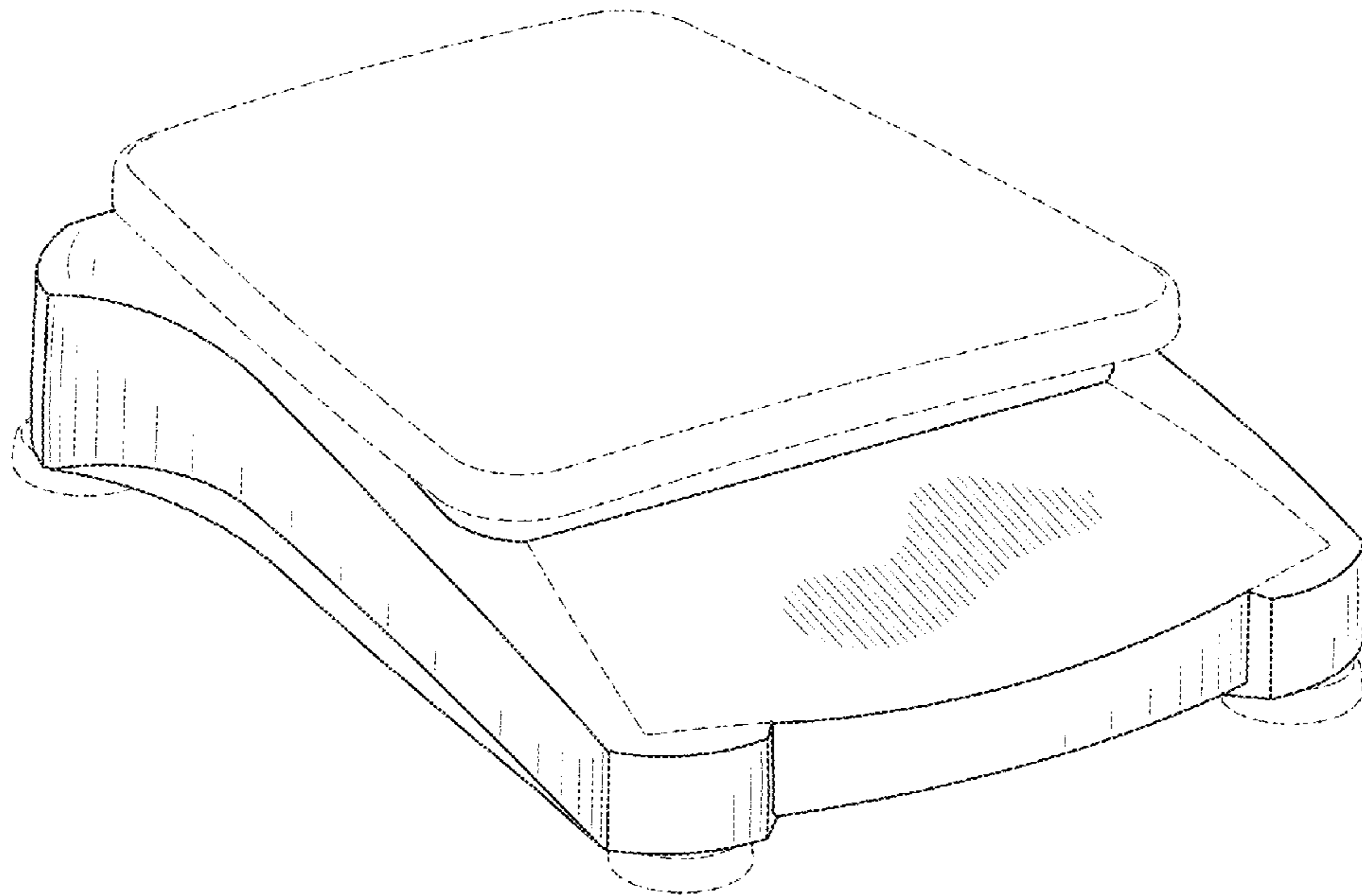

FIG-8

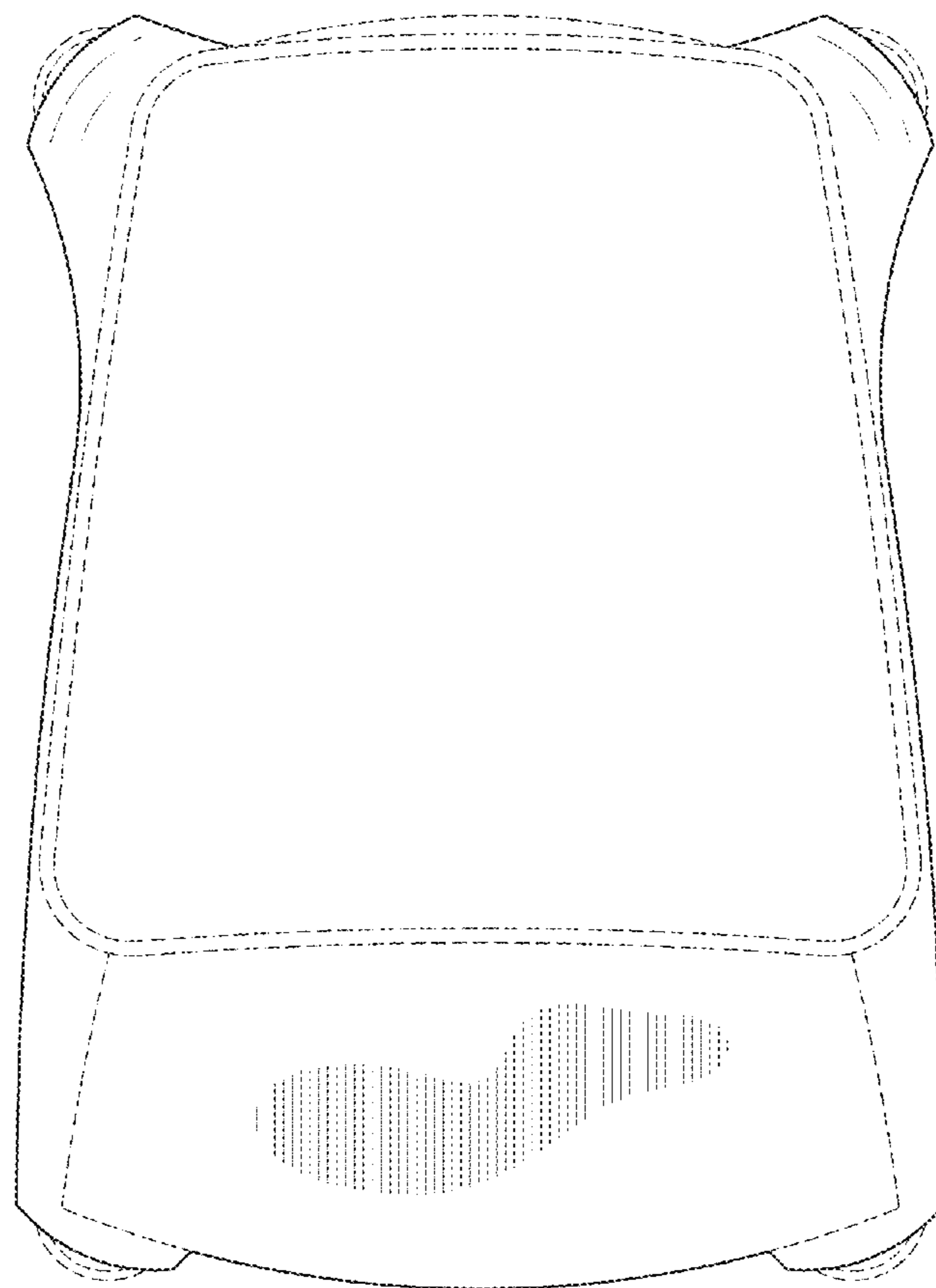

FIG-9



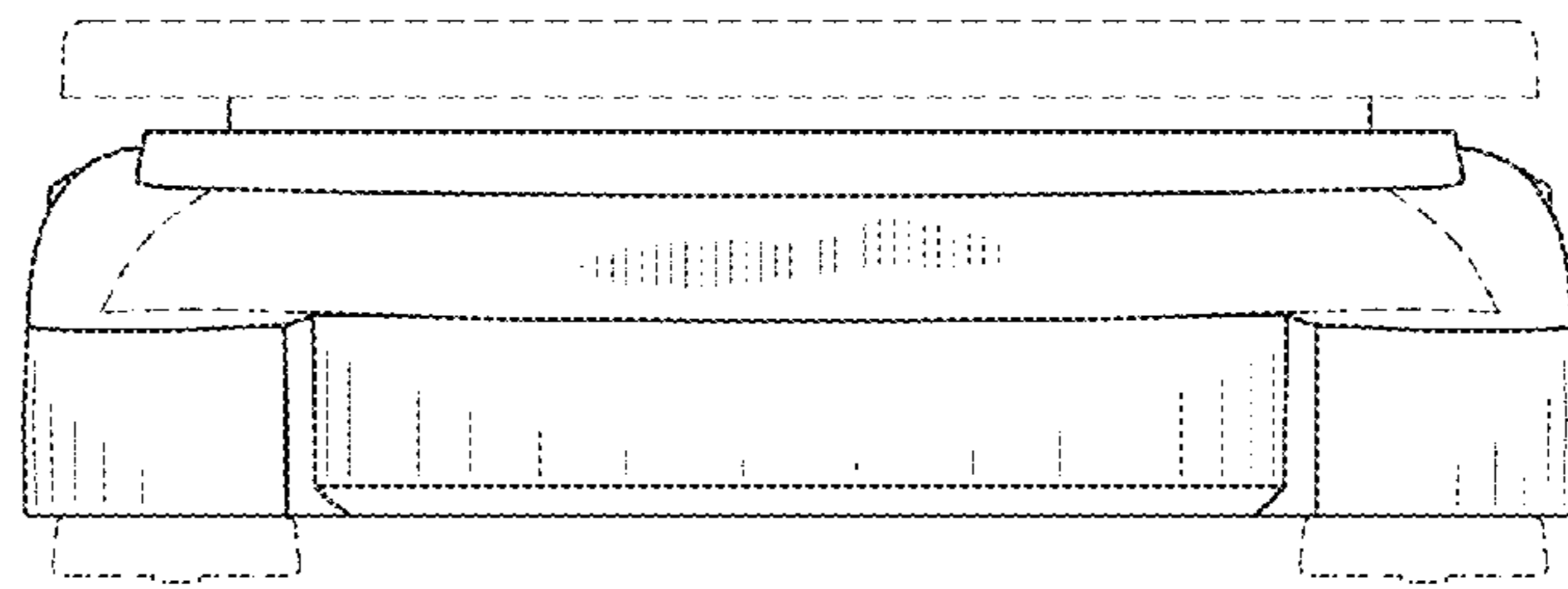

FIG-10

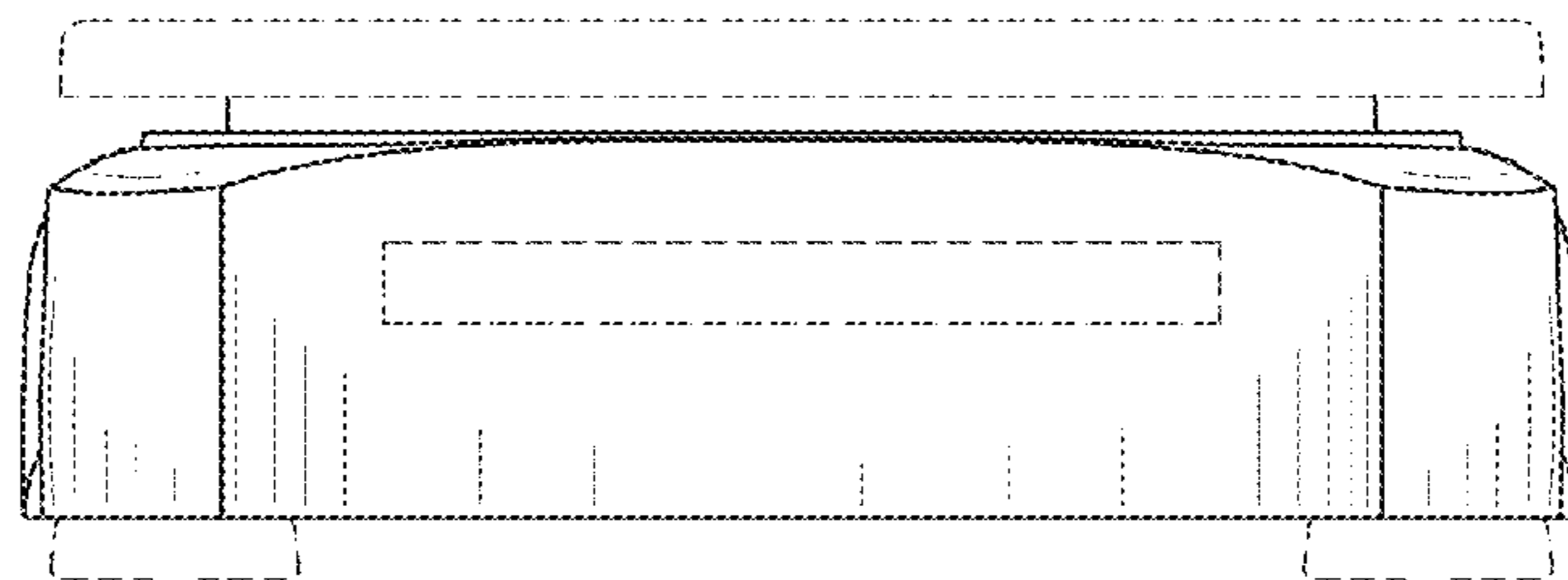

FIG-11

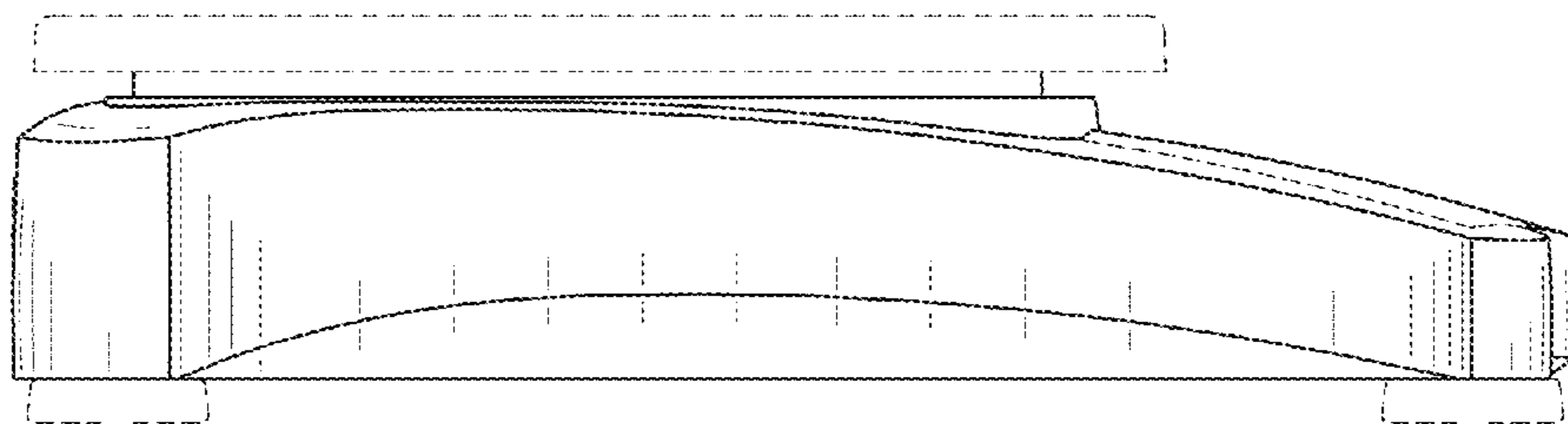

FIG-12

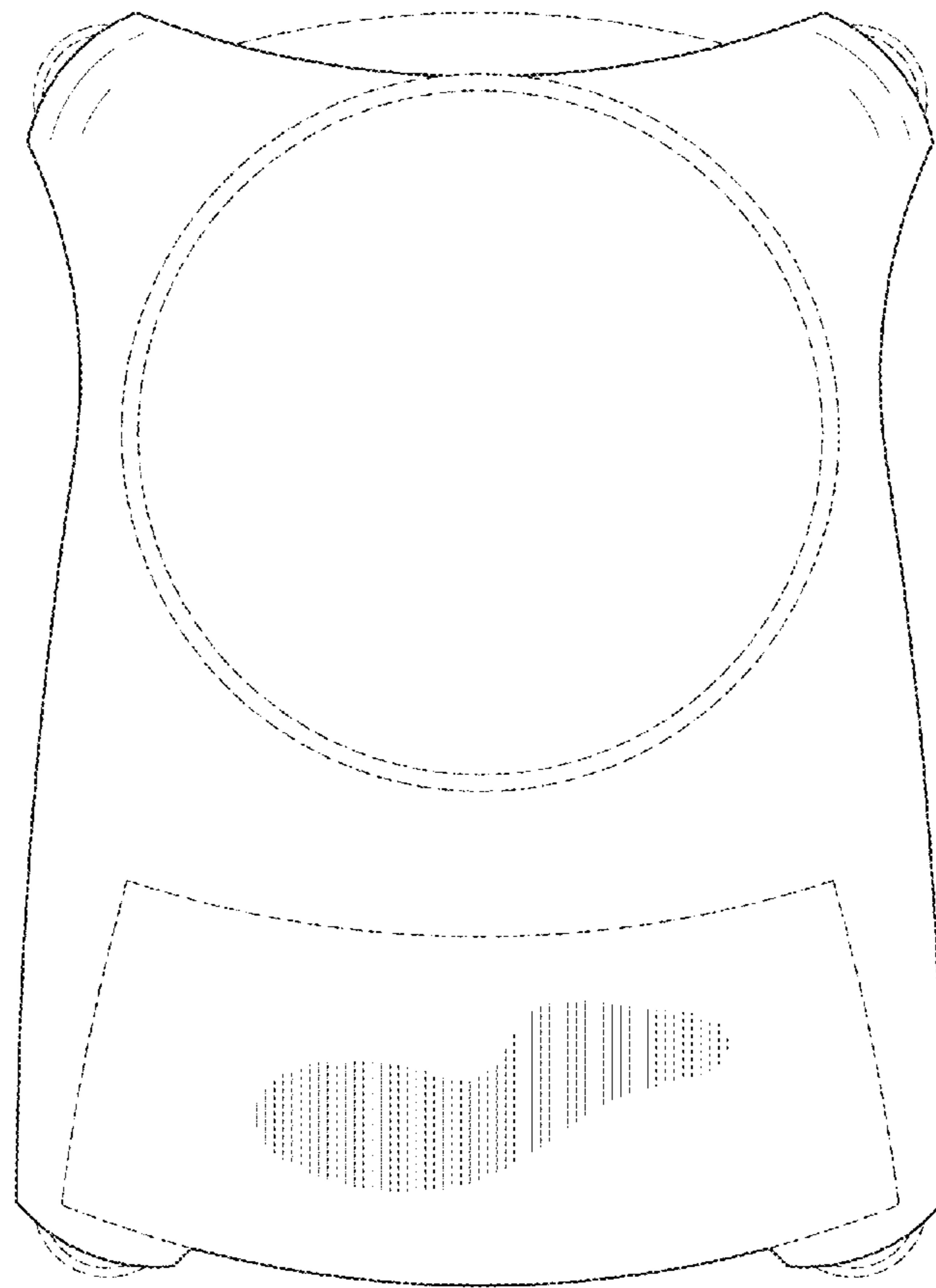

FIG-13

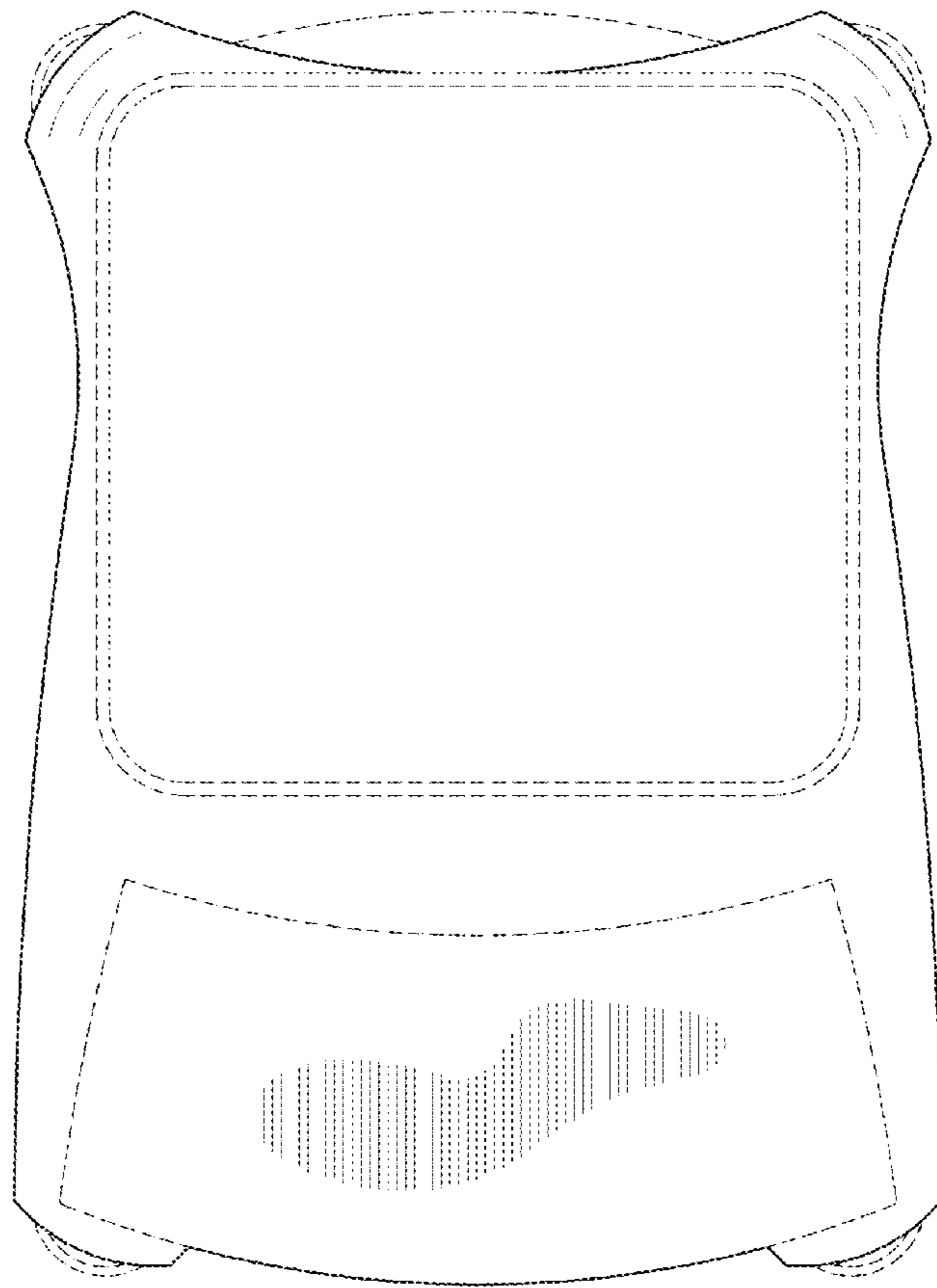

FIG-14

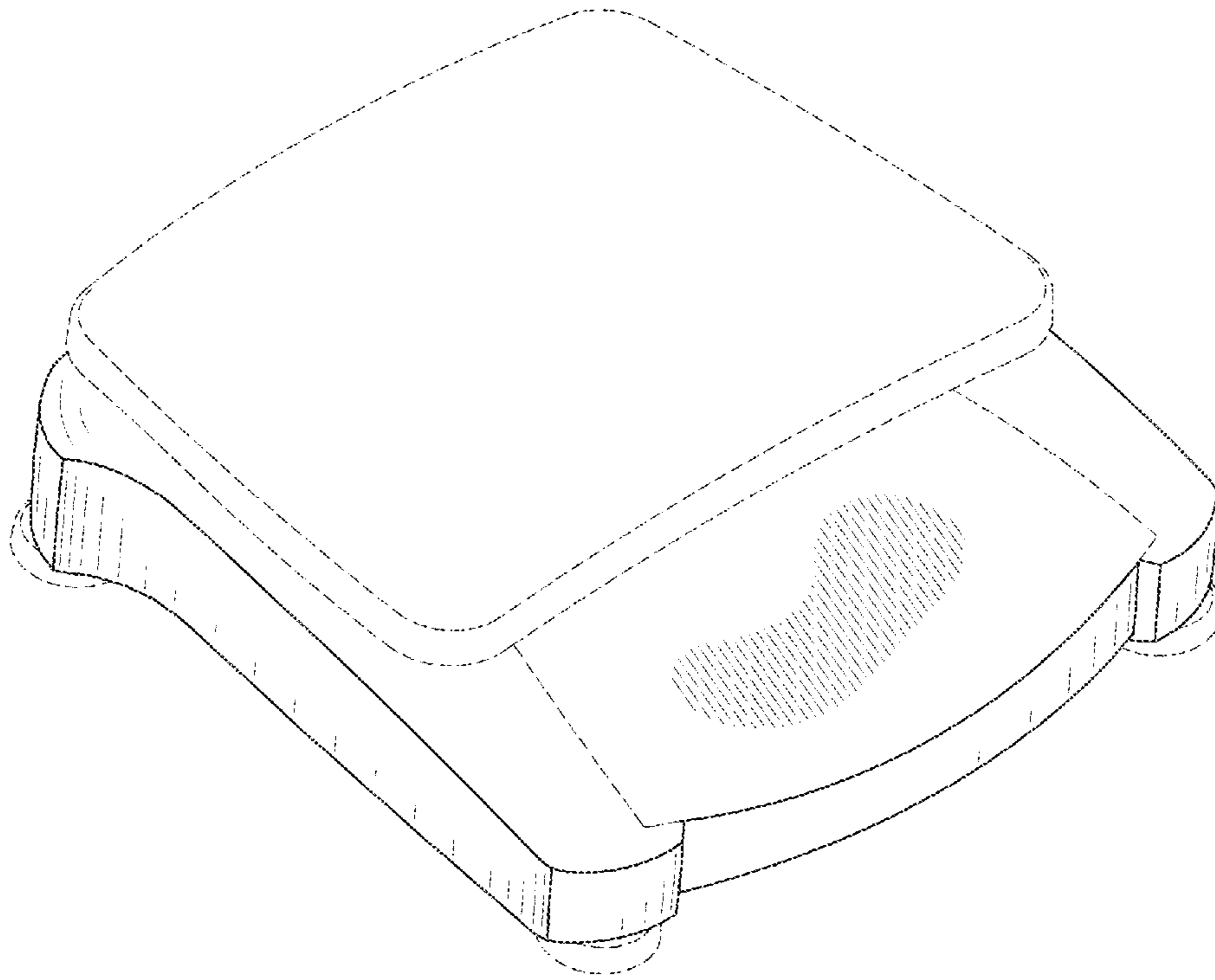

FIG-15

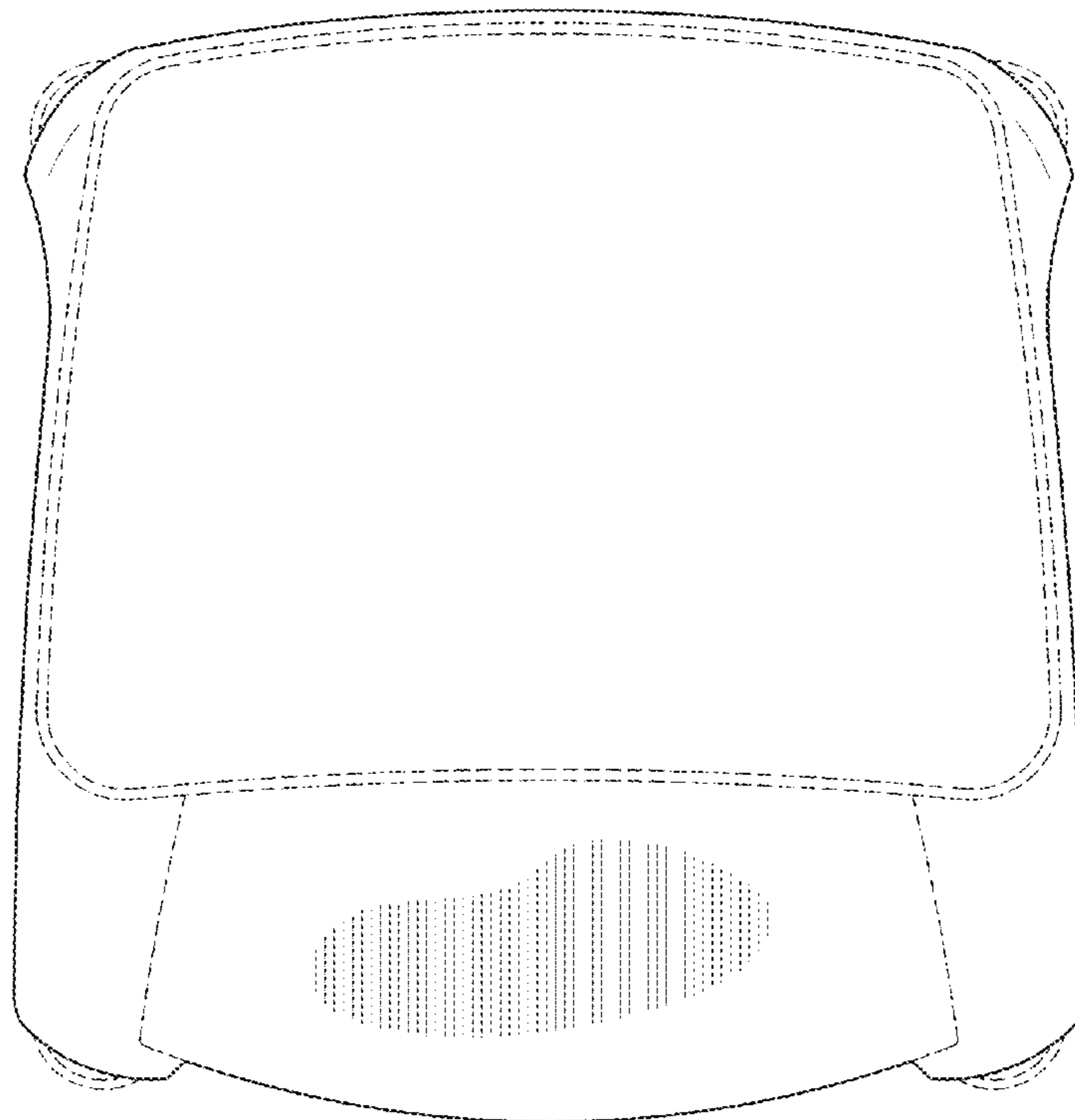

FIG-16

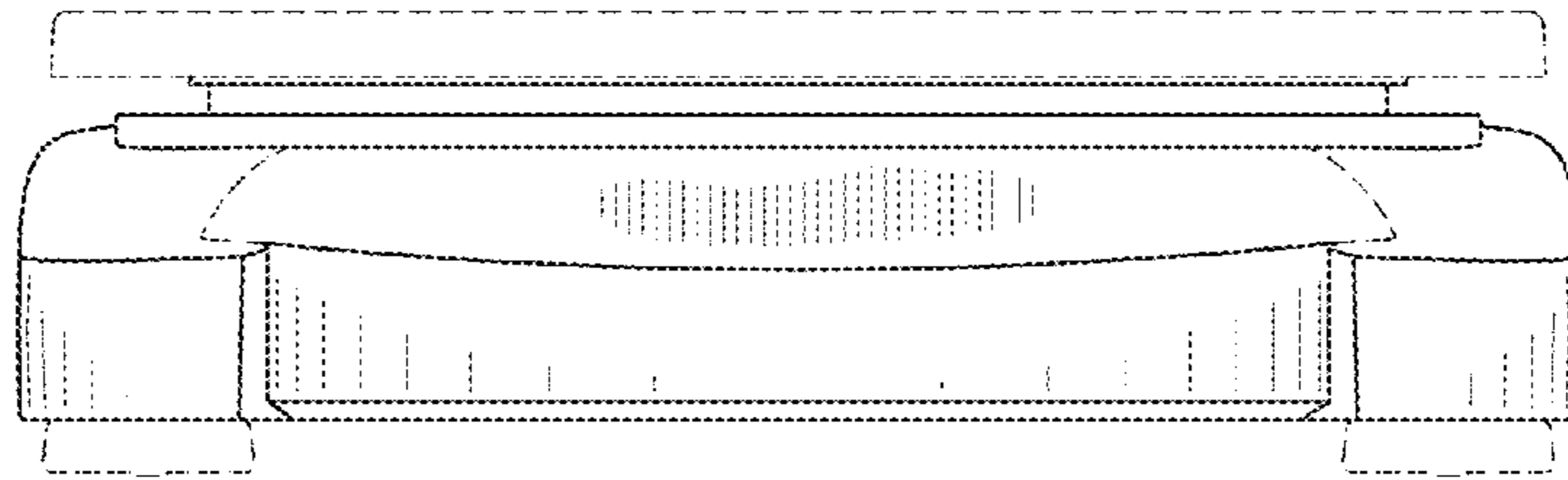

FIG-17

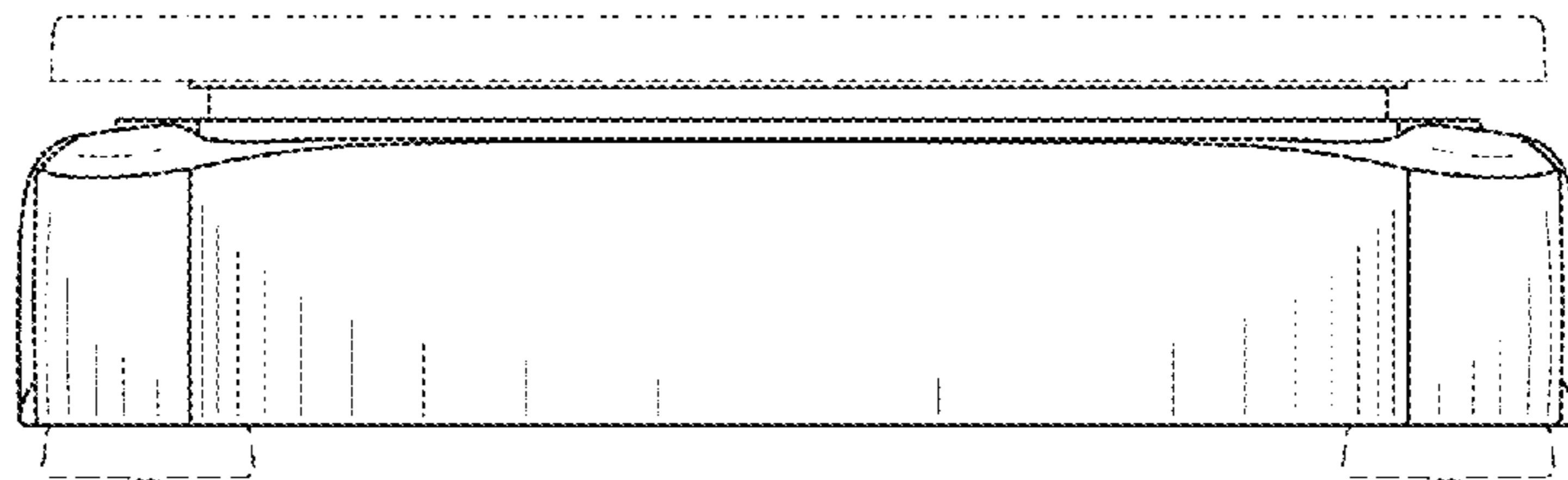

FIG-18

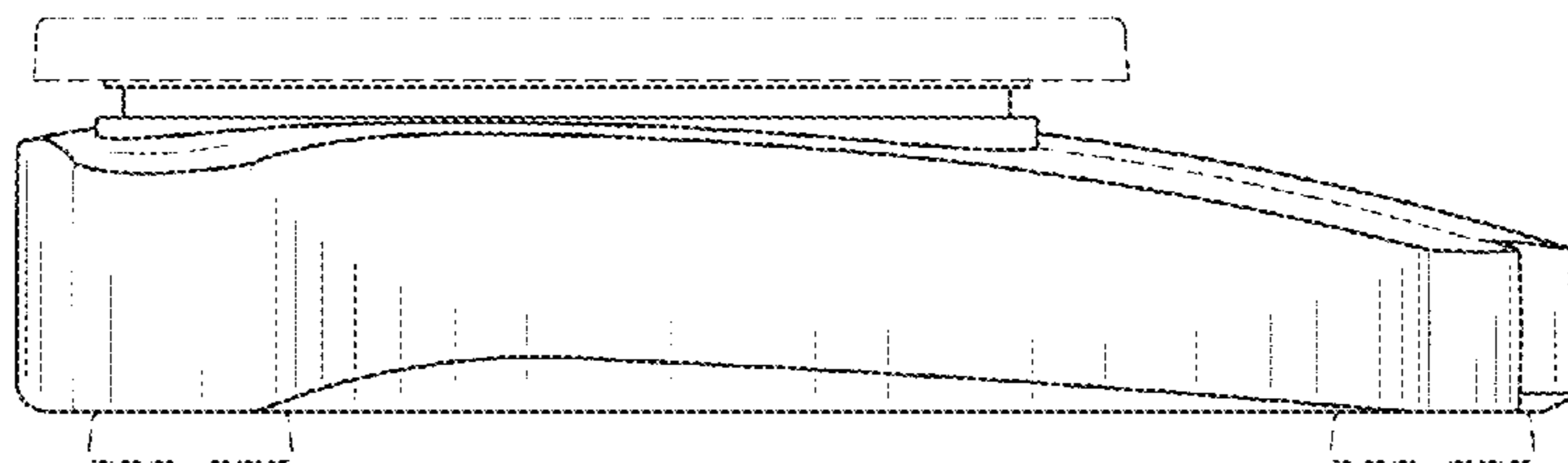

FIG-19

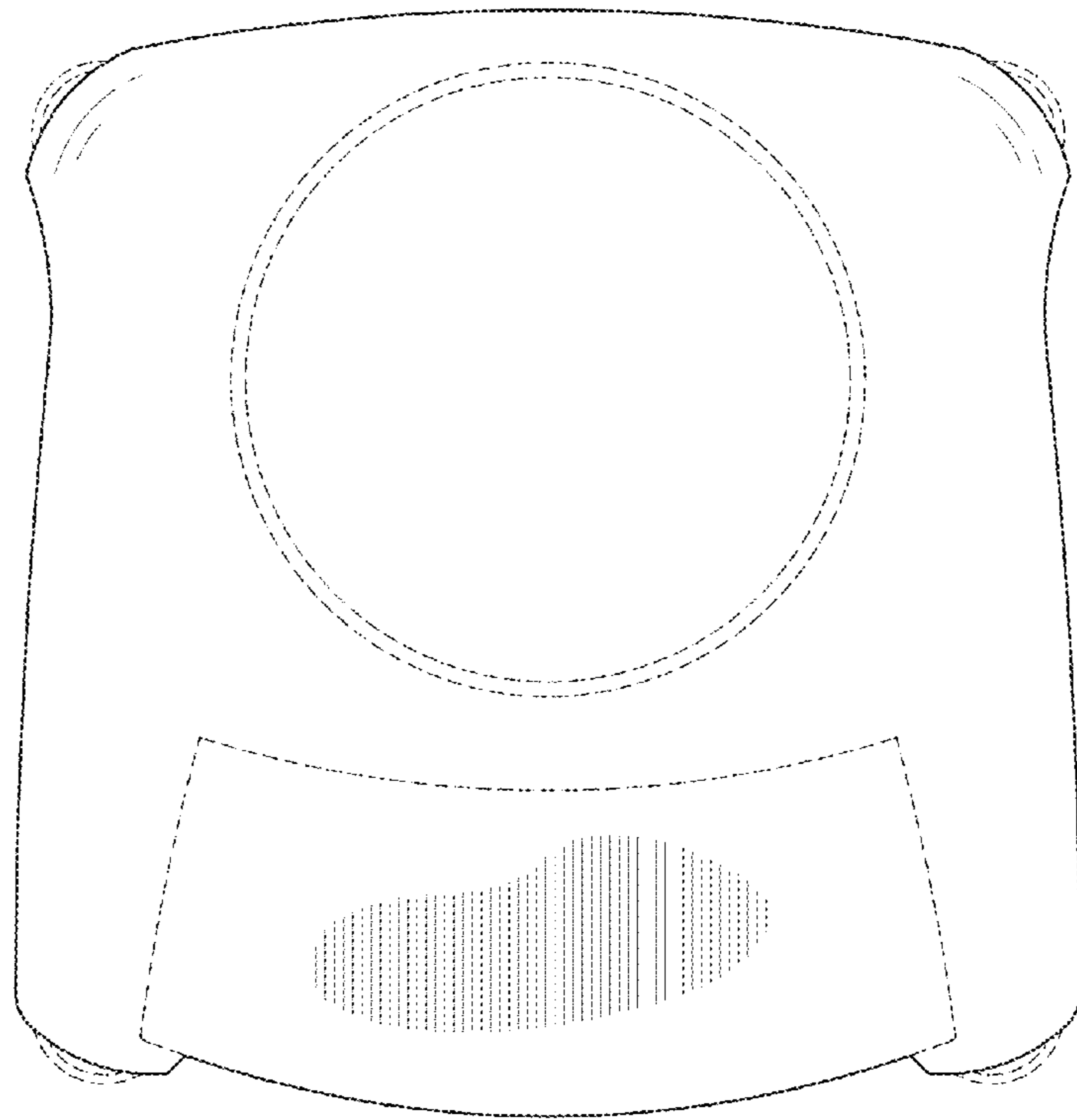

FIG-20



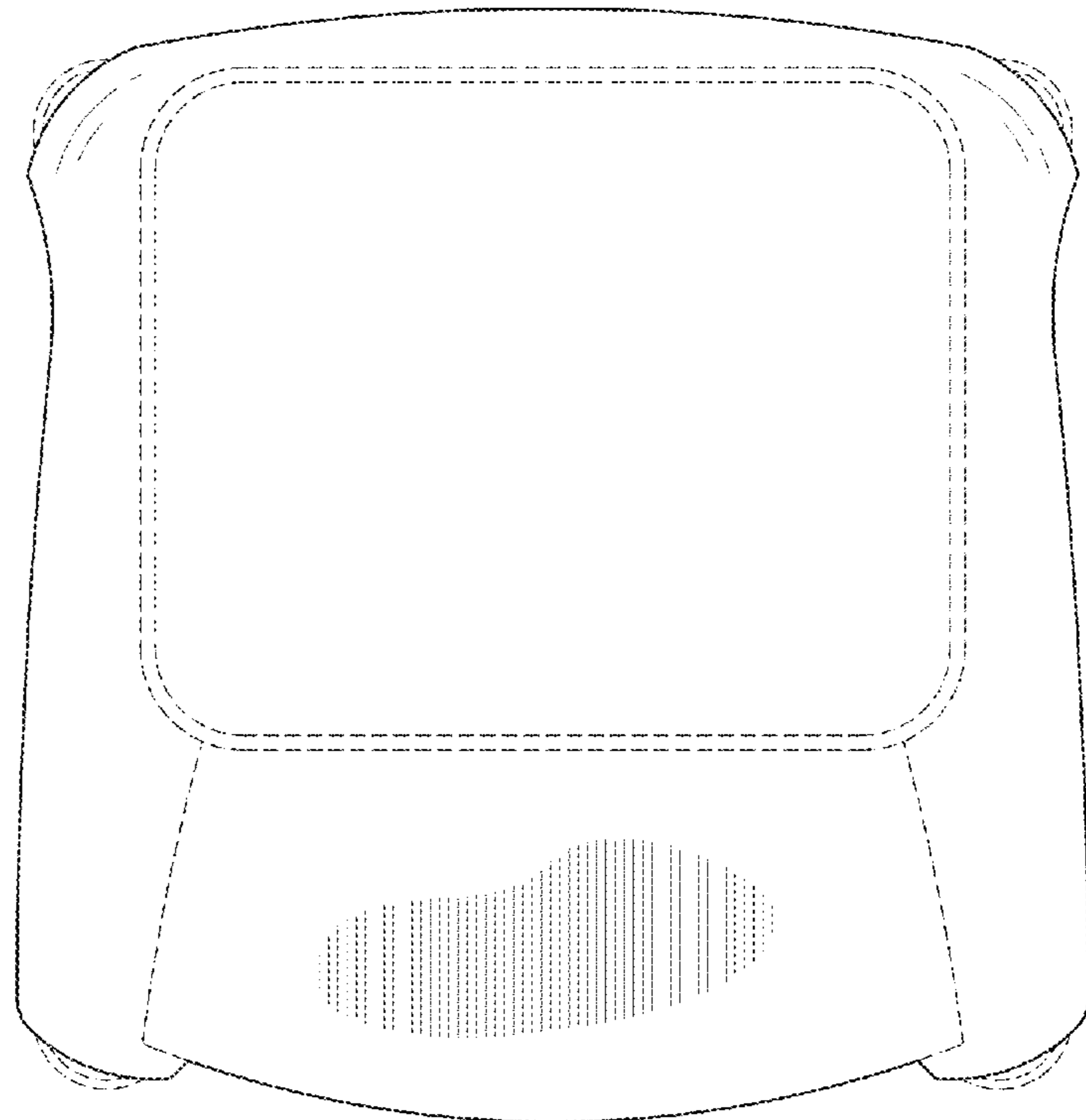

FIG-21