



US00D670137S

(12) **United States Design Patent**
Gilbert

(10) **Patent No.:** **US D670,137 S**

(45) **Date of Patent:** **** Nov. 6, 2012**

(54) **INSULATED BOTTLE**

(75) Inventor: **Tyler Sean Gilbert**, Bellevue, WA (US)

(73) Assignee: **Pacific Market International, LLC**,
Seattle, WA (US)

(**) Term: **14 Years**

(21) Appl. No.: **29/413,001**

(22) Filed: **Feb. 9, 2012**

Related U.S. Application Data

(62) Division of application No. 29/396,383, filed on Jun. 29, 2011, now Pat. No. Des. 656,364, which is a division of application No. 29/378,148, filed on Oct. 29, 2010, now Pat. No. Des. 643,246, which is a division of application No. 29/345,052, filed on Oct. 8, 2009, now Pat. No. Des. 628,018.

(51) **LOC (9) Cl.** **07-01**

(52) **U.S. Cl.** **D7/608**

(58) **Field of Classification Search** D7/603-608,
D7/509, 511; D9/531, 537, 549, 552, 555,
D9/559; 215/12.1, 12.2, 13.1; 16/110.1;
220/752, 753, 755, 756

See application file for complete search history.

(56) **References Cited**

U.S. PATENT DOCUMENTS

1,044,757	A	11/1913	Decker et al.
D108,417	S	2/1938	Ambrose
D179,880	S	3/1957	Bramming
D182,708	S	5/1958	Bramming
2,981,562	A	6/1961	Long
D206,914	S	2/1967	Phillips
D222,521	S	10/1971	Johnson
D268,727	S	4/1983	Nestrock
D274,209	S	6/1984	Kikuchi
D295,355	S	4/1988	Leung
D306,953	S	4/1990	Kase et al.
D308,477	S	6/1990	van den Ordel
D309,237	S	7/1990	Kobayashi et al.

D309,568	S	7/1990	Beton
D314,888	S	2/1991	Mano et al.
D321,628	S	11/1991	Kobayashi et al.
D329,385	S	9/1992	Alves Machado Guedes
D354,915	S	1/1995	Schneider et al.
D360,113	S	7/1995	Takahashi
D378,652	S	4/1997	Yamanaka et al.
D379,742	S	6/1997	Enomota et al.
D379,743	S	6/1997	Enomota et al.
D398,236	S	9/1998	Huang
D411,716	S	6/1999	Besser et al.
D416,448	S	11/1999	Webb et al.
D422,455	S	4/2000	Kato
D425,374	S	5/2000	Besser et al.
D425,422	S	5/2000	David
D428,774	S	8/2000	Moran, Jr.
D429,118	S	8/2000	Hurlbut

(Continued)

OTHER PUBLICATIONS

U.S. Appl. No. 29/305,912, filed Mar. 31, 2008, Gilbert.

(Continued)

Primary Examiner — Terry Wallace

(74) *Attorney, Agent, or Firm* — Davis Wright Tremaine
LLP; George C. Rondeau, Jr.

(57) **CLAIM**

The ornamental design for an insulated bottle, as shown and described.

DESCRIPTION

FIG. 1 is a top, rear perspective view of an insulated bottle showing my new design.

FIG. 2 is a rear elevation view thereof.

FIG. 3 is a front elevation view thereof.

FIG. 4 is a left side view thereof.

FIG. 5 is a right side view thereof.

FIG. 6 is a top plan view thereof; and,

FIG. 7 is a bottom plan view thereof.

The broken lines are for illustrative purposes only and form no part of the claimed design.

1 Claim, 6 Drawing Sheets

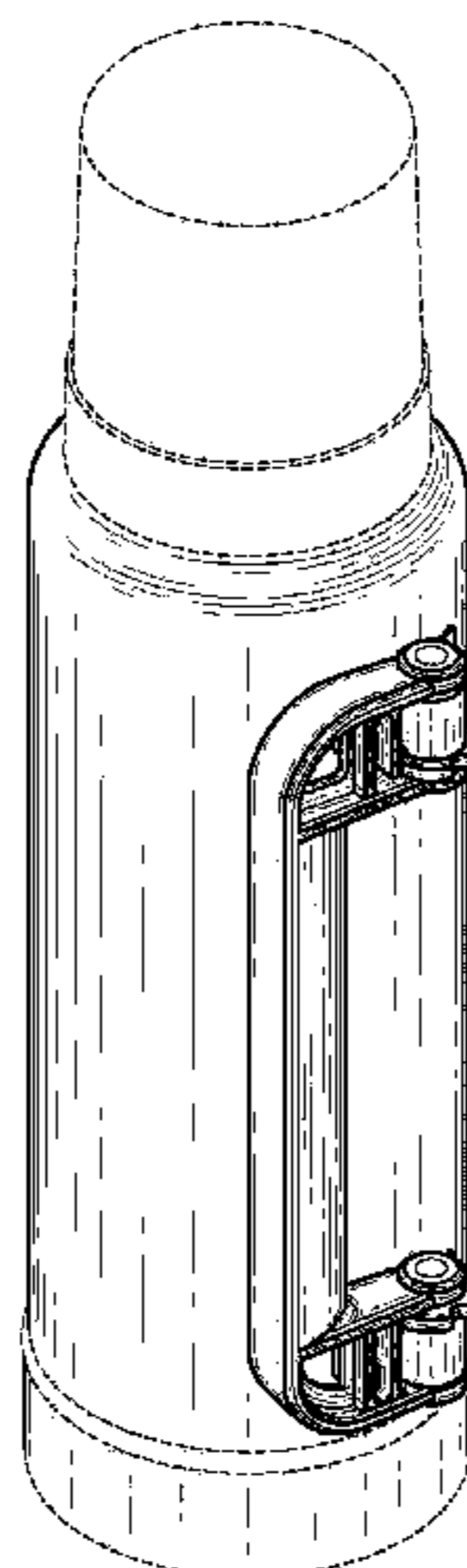

U.S. PATENT DOCUMENTS

D429,119	S	8/2000	Hurlbut	
D430,769	S	9/2000	Hurlbut	
6,119,888	A *	9/2000	Goto et al.	220/592.27
D431,969	S	10/2000	Hurlbut	
D432,367	S	10/2000	Segura	
D434,611	S	12/2000	Yu	
D437,528	S	2/2001	Kitamura et al.	
D467,130	S	12/2002	Janky	
D488,675	S	4/2004	Moore	
6,764,622	B2 *	7/2004	Moran	264/46.5
D528,431	S	9/2006	Brandt et al.	
D530,219	S	10/2006	Brandt et al.	
D533,032	S	12/2006	Liu et al.	
D553,914	S *	10/2007	Wahl	D7/608
D572,981	S *	7/2008	Carreno	D7/608
D587,533	S *	3/2009	Carreno	D7/608
D592,909	S	5/2009	Alviar et al.	
D615,823	S *	5/2010	Gilbert	D7/608
D623,481	S *	9/2010	Moran	D7/608

OTHER PUBLICATIONS

U.S. Appl. No. 29/344,046, filed Sep. 22, 2009, Gilbert.
 Aladdin International Corporation® “Thermal Retention Products Price List,” Feb. 1, 1986.
 Aladdin® Stanley® “Half Gallon Unbreakable Steel Vacuum Bottle 1.9 Liters” Brochure.
 Aladdin® “Stanley® Quart Unbreakable Steel Vacuum Bottle 950 mL” Brochure.
 Aladdin® “Stanley® Wide Mouth Unbreakable Steel Vacuum Bottle 24 oz. (710mL)” Brochure.
 Aladdin® “Stanley® Quart with two 12-oz. Stanley Foam-Insulated Travel Mugs, Unbreakable Steel Vacuum Bottle (950mL)” Brochure.

Aladdin® “Rugged American™ Quart Steel Thermos” Brochure.
 Aladdin® “Envoy™ Unbreakable Steel Vacuum Bottle, Pint (470mL)” Brochure.
 Aladdin® “Envoy 950™ Unbreakable Steel Vacuum Bottle, Quart (950mL)” Brochure.
 Aladdin® “Executive™ 0.7 Liter, 0.5 Liter, 1 Liter, The All Steel Bottles . . . That Really Mean Business” Brochure.
 Aladdin® “Glass Vacuum Bottles, Items 6016 and 6032” Brochure.
 Aladdin® “The Omega” Brochure, Aladdin Industries Nashville, TN, 1993.
 Aladdin® “Stanley® Insulated Lunch Cooler 7 Quart Capacity” Brochure.
 Aladdin® “Stanley® Combo” Brochure.
 Aladdin® “Black Stanley® Quart with Two Foam-Insulated 12-oz. Mugs Unbreakable Steel Vacuum Bottle 950 mL” Brochure.
 Aladdin® “The Stanley Fourth Quarter Advertising Campaign” Brochure.
 Aladdin® Stanley® 10 N 10 Rugged American Item #4232, Quart, Half Gallon and 24 Ounce Widemouth Stanley® Item #4032, 4032BL, 4064, 4024, Stanley® Cooler Item #4100, Brochure.
 Aladdin® “Heavy Duty Thermo Bottles 10 N 10, Item #2134 and Item 2123” Brochure.
 Aladdin® “Stanley® Gift Sets Item #4032SBL” Brochure.
 Pacific Market, Inc. “Joe Vacuum Bottle” worksheet, Dec. 1998.
 Contemporary Classics “1996 Centennial Olympic Collection” Brochure.
 Stanley classic Bottle shown on photo. Sold more than one year prior to Mar. 31, 2008.
 Stanley Outdoor Bottle shown on photo. Sold more than one year prior to Mar. 31, 2008.

* cited by examiner

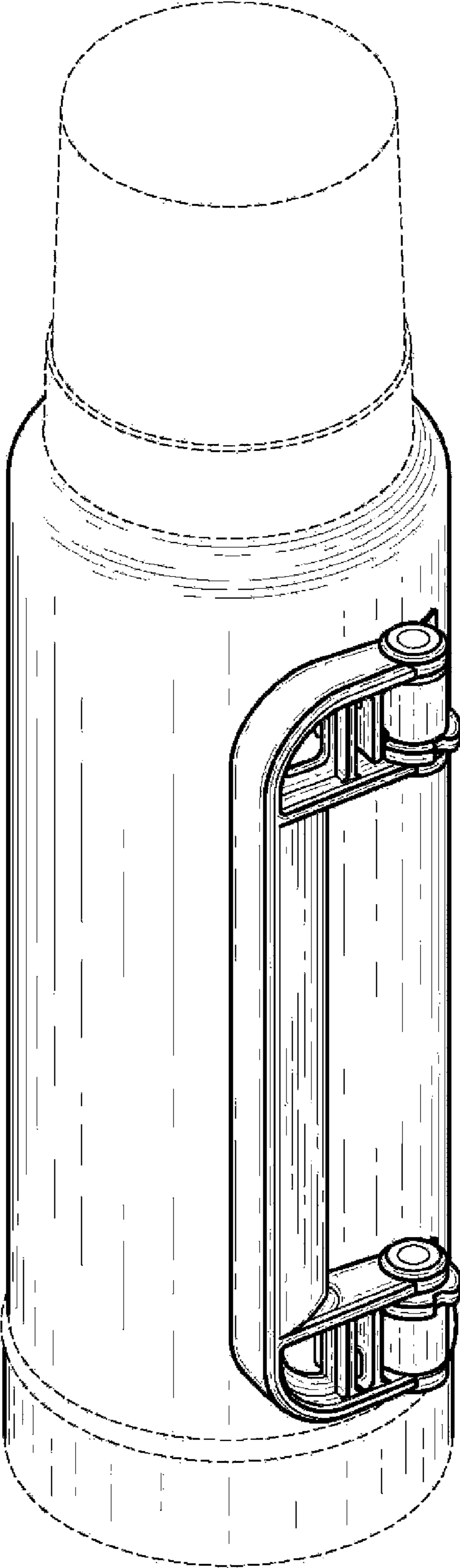

Fig. 1

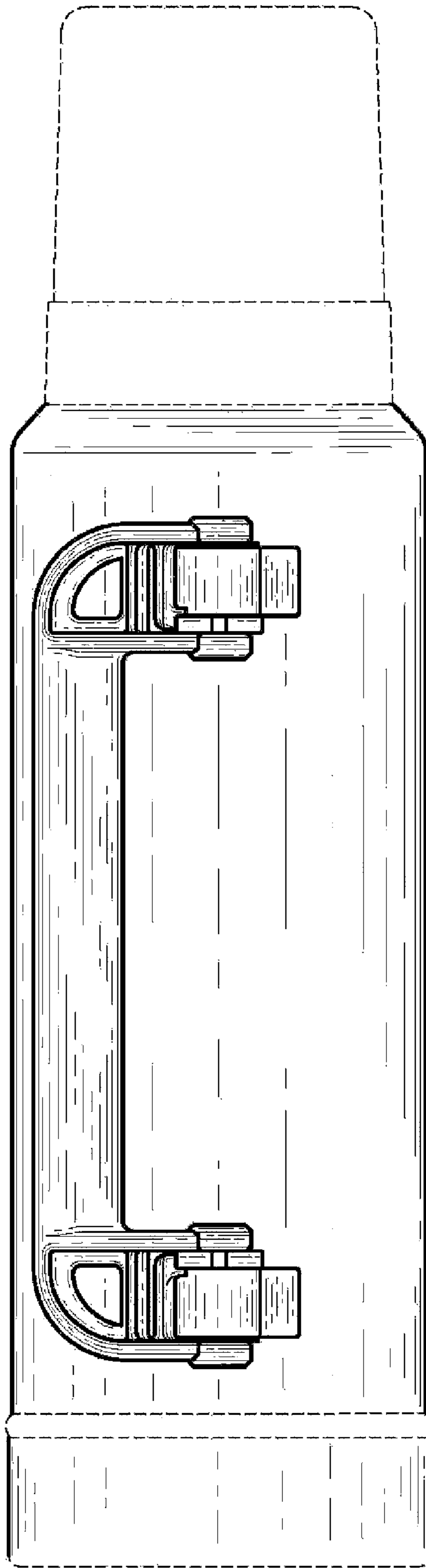

Fig. 2

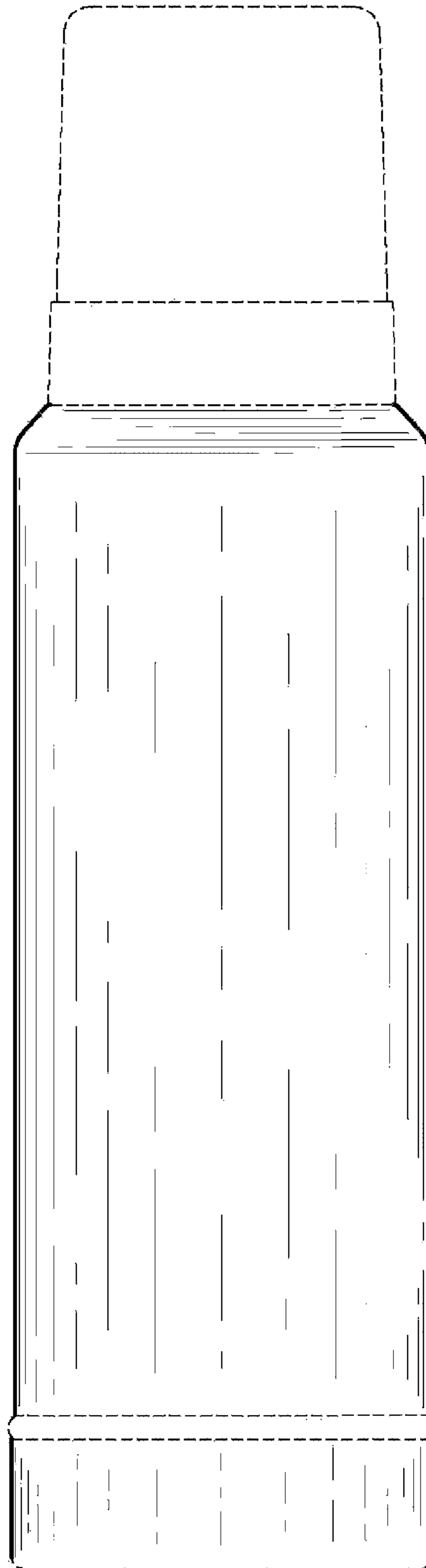

Fig. 3

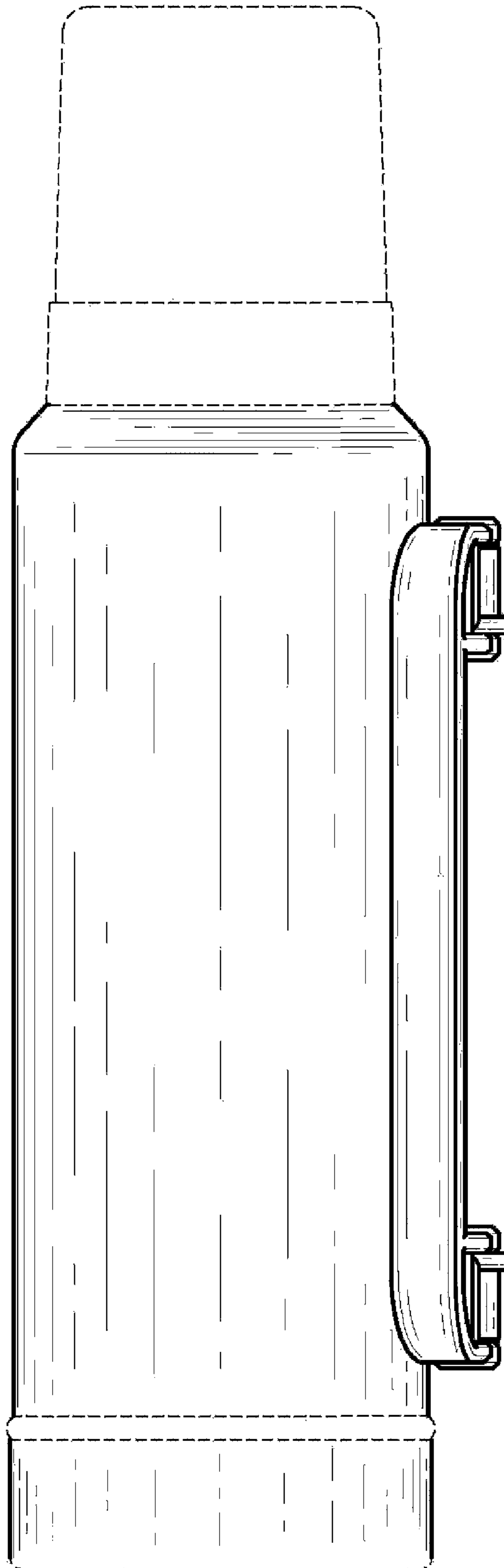

Fig. 4

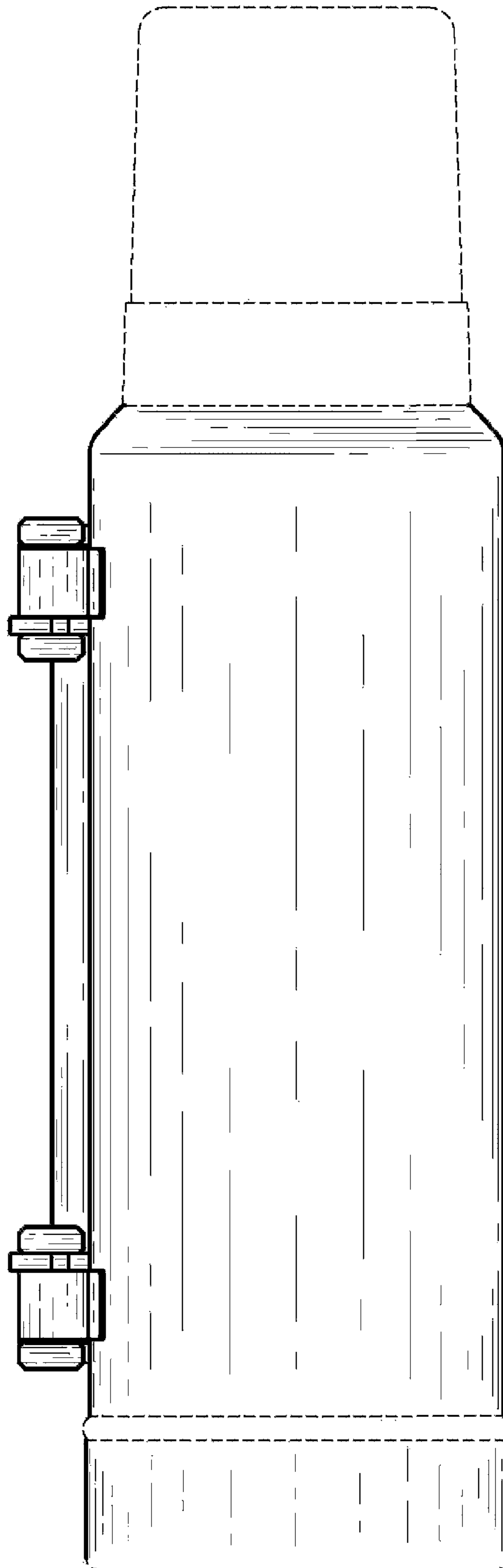

Fig. 5

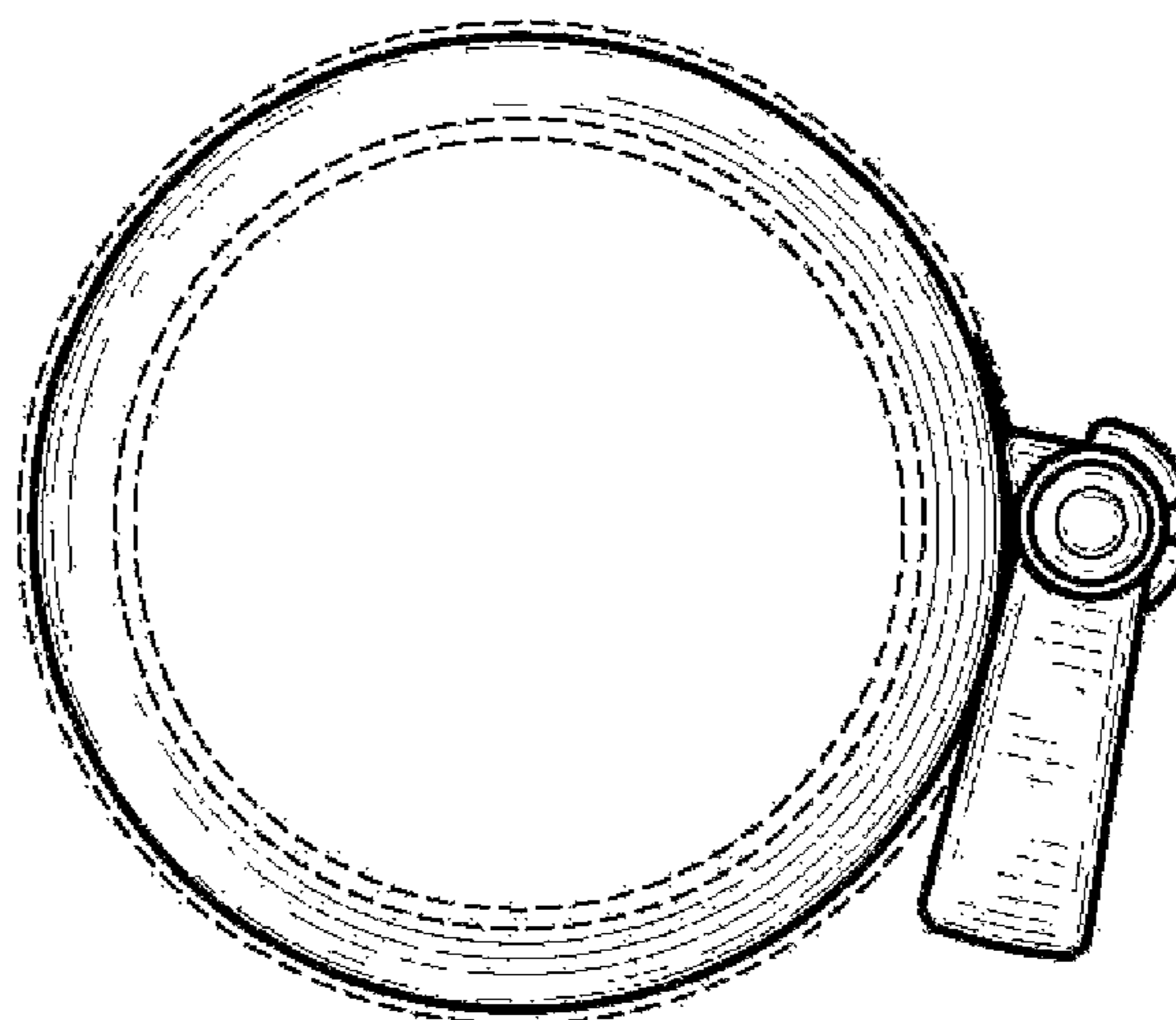

Fig. 6

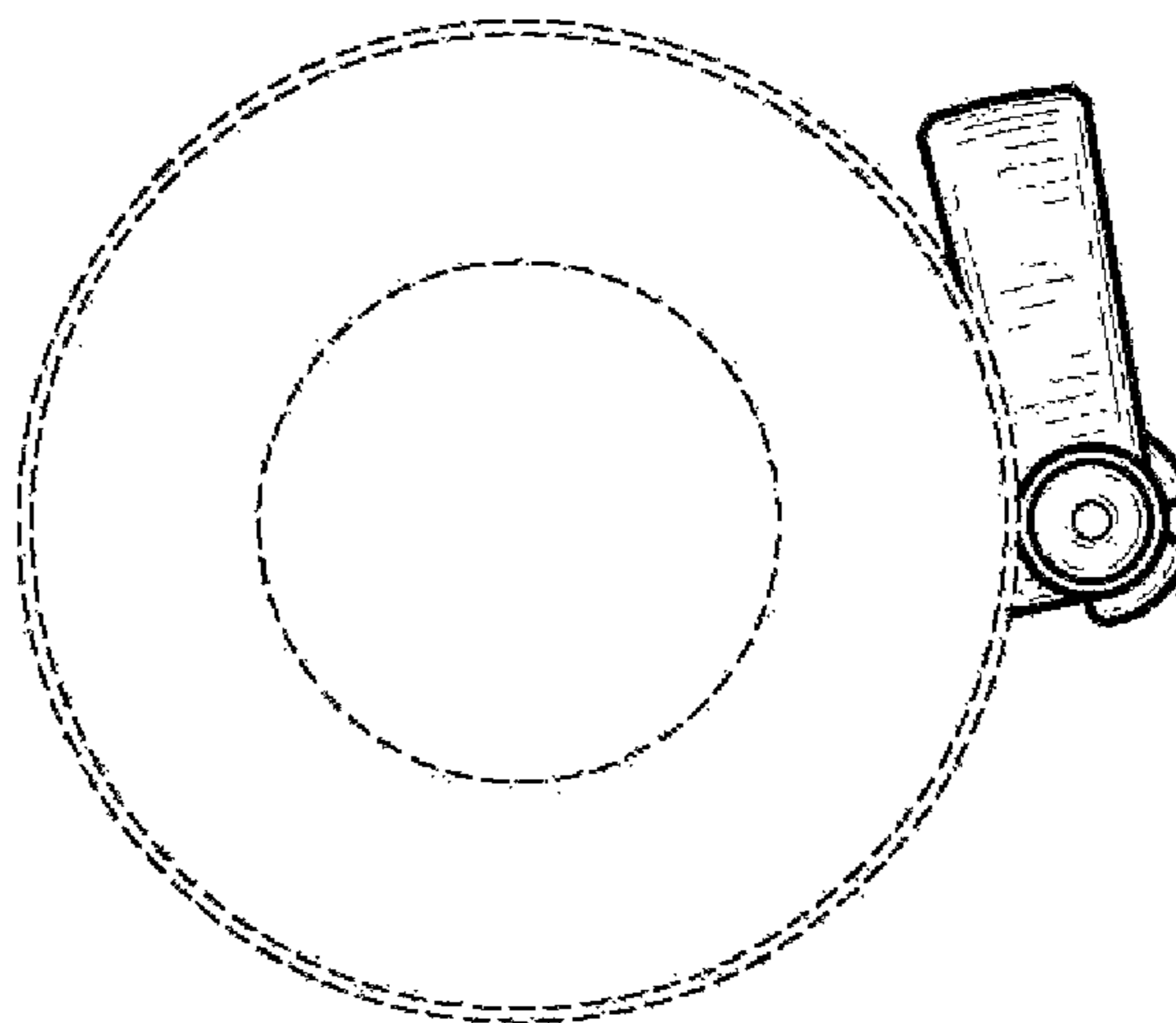

Fig. 7