



US00D670128S

(12) **United States Design Patent**  
**Price**

(10) **Patent No.:** **US D670,128 S**  
(45) **Date of Patent:** **\*\* Nov. 6, 2012**

- (54) **BORDER FOR MATTRESSES**
- (75) Inventor: **Elvin C. Price**, Dacula, GA (US)
- (73) Assignee: **Atlanta Attachment Company**,  
Lawrenceville, GA (US)
- (\*\*) Term: **14 Years**
- (21) Appl. No.: **29/419,269**
- (22) Filed: **Apr. 26, 2012**
- (51) **LOC (9) Cl.** ..... **06-09**
- (52) **U.S. Cl.** ..... **D6/605**
- (58) **Field of Classification Search** ..... D6/595,  
D6/596, 601, 604, 605; 5/690, 703, 704,  
5/716, 717, 739, 740, 657.5, 675, 680, 688,  
5/700, 706, 737, 499  
See application file for complete search history.

(56) **References Cited**

U.S. PATENT DOCUMENTS

1,355,729	A *	10/1920	Bennett	5/739
1,413,577	A *	4/1922	Eldredge	5/739
1,762,106	A *	6/1930	Pittoni	5/739
1,892,203	A *	12/1932	Burton et al.	5/717
2,200,011	A *	5/1940	Riley	5/716
2,229,385	A *	1/1941	Munson et al.	112/475.01
2,611,910	A *	9/1952	Bell	267/91
2,975,437	A *	3/1961	Freeman	5/716
4,554,693	A	11/1985	Calloway	
6,640,362	B1	11/2003	Kimball	
D551,011	S	9/2007	Van Patten	
D551,012	S	9/2007	Van Patten	
D552,397	S	10/2007	Van Patten	
D622,088	S	8/2010	Morrison	
D622,531	S	8/2010	Morrison et al.	
D633,322	S	3/2011	Morrison	
D640,082	S	6/2011	Morrison	
D642,413	S	8/2011	Rinehart	

- D651,443 S 1/2012 Wightman
- D659,459 S 5/2012 Jung et al.
- D662,751 S 7/2012 Morrison et al.

\* cited by examiner

*Primary Examiner* — Janice Seeger

(74) *Attorney, Agent, or Firm* — Womble Carlyle Sandridge & Rice LLP

(57) **CLAIM**

The ornamental design for a border for mattresses, as shown and described.

**DESCRIPTION**

FIG. 1 is a perspective view of a border for mattresses showing my new design.

FIG. 2 is a right side end view of the border for mattresses of FIG. 1.

FIG. 3 is a left side end view of the border for mattresses of FIG. 1.

FIG. 4 is a front view of the border for mattresses of FIG. 1.

FIG. 5 is a rear view of the border for mattresses of FIG. 1.

FIG. 6 is a top plan view of the border for a mattress of FIG. 1;

FIG. 7 is a bottom plan view of the border for a mattress of FIG. 1;

FIG. 8 is an enlarged side view of the border for a mattress of FIG. 1, showing the mattress in greater detail;

FIG. 9 is a perspective view of the border for a mattress, showing a second embodiment of my new design;

FIG. 10 is a right end view of the border for a mattress of FIG. 9;

FIG. 11 is a left end view of the border for a mattress of FIG. 9;

FIG. 12 is a front view of the border for a mattress of FIG. 9; and,

FIG. 13 is a rear view of a border for a mattress of FIG. 9.

**1 Claim, 9 Drawing Sheets**

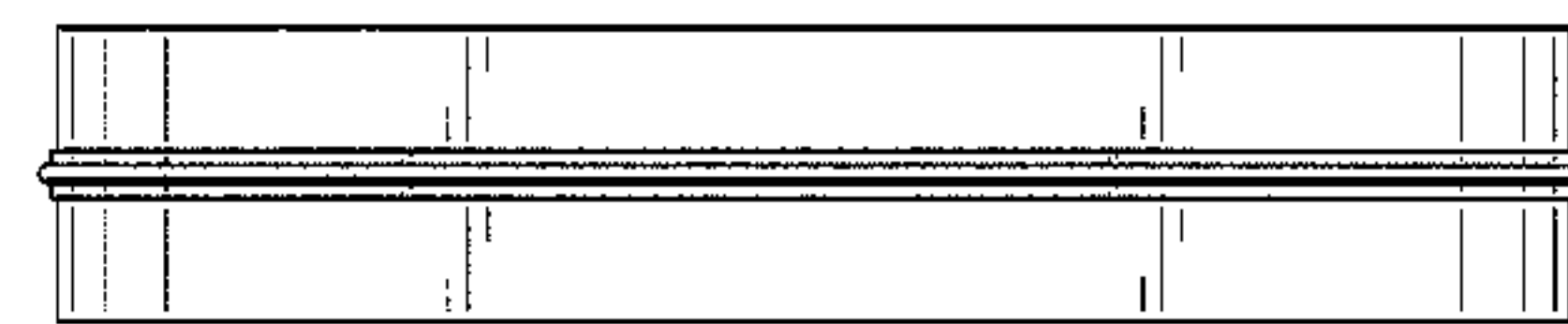
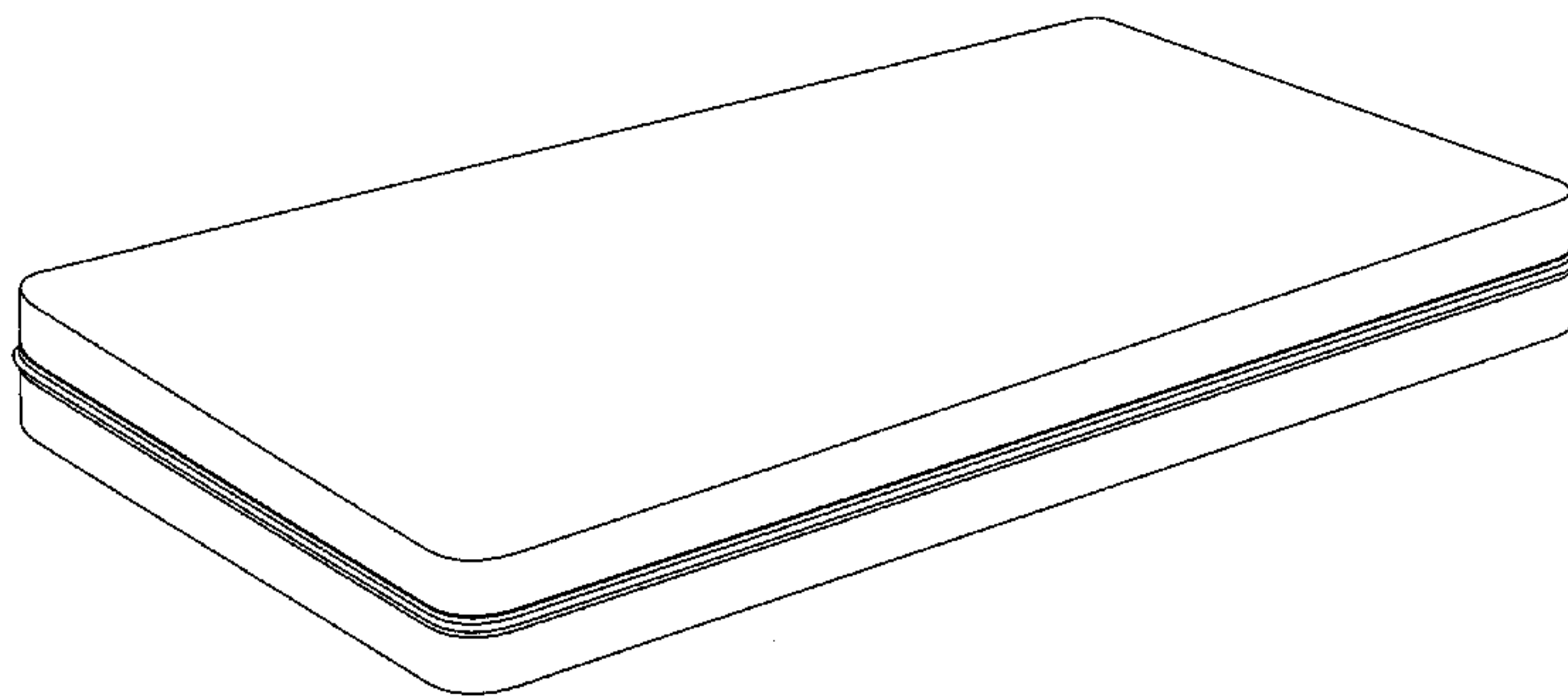

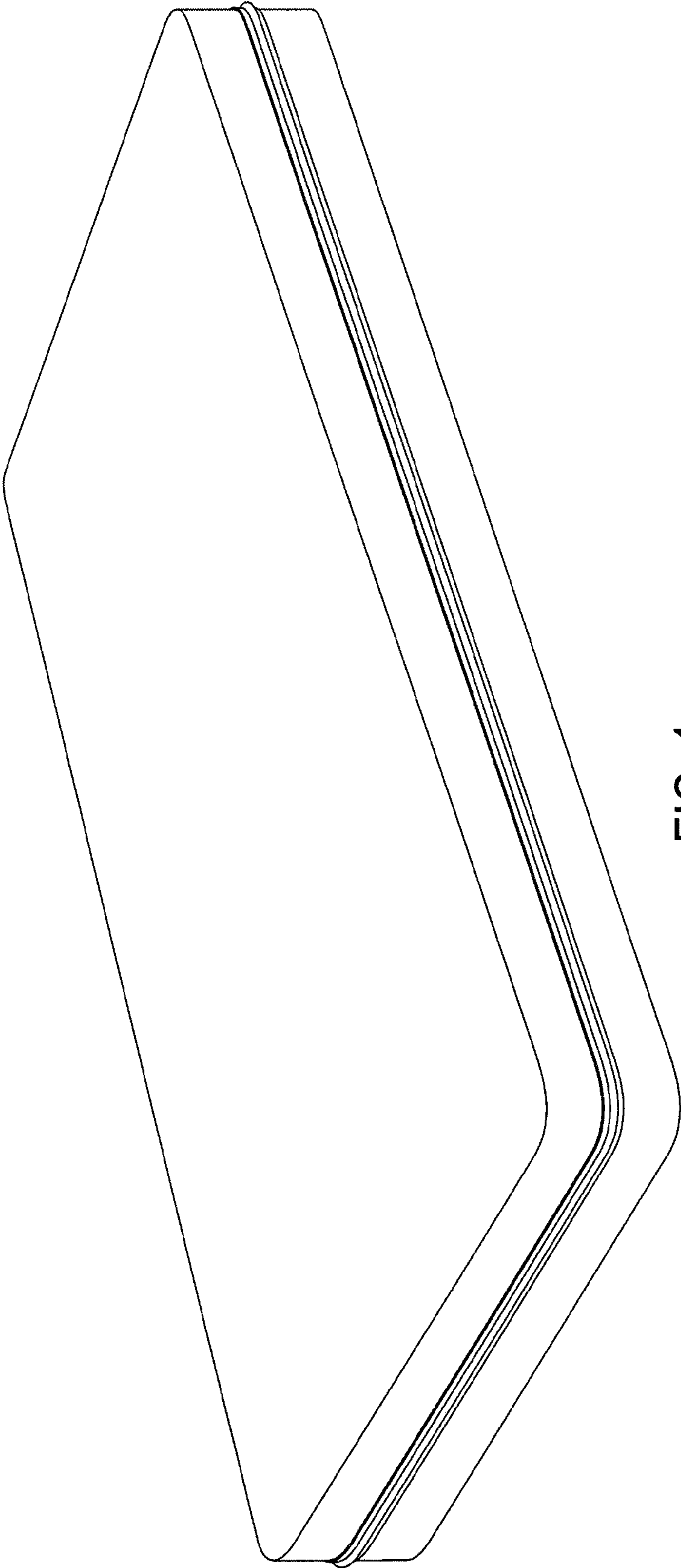

FIG. 1

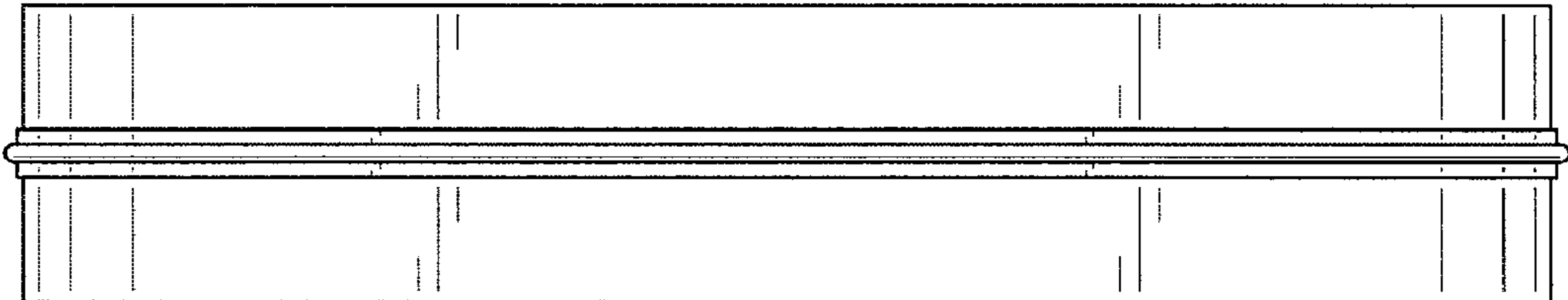

FIG. 2

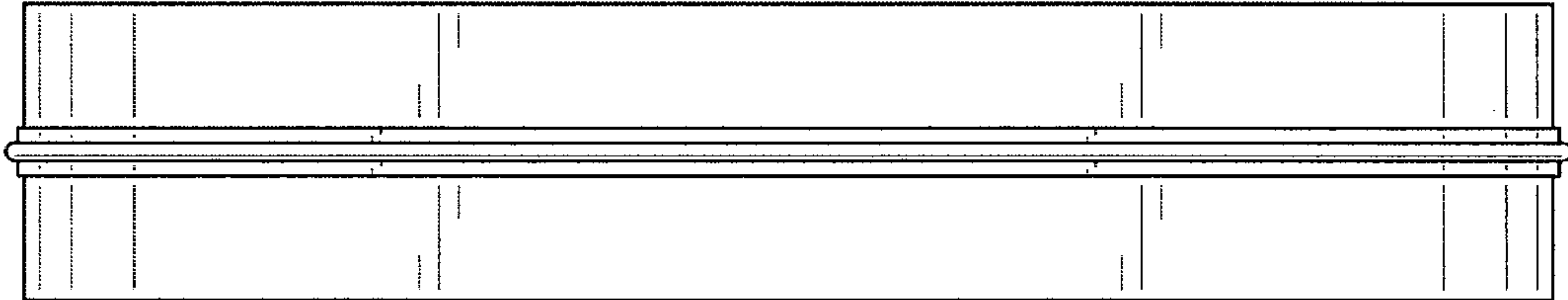

FIG. 3

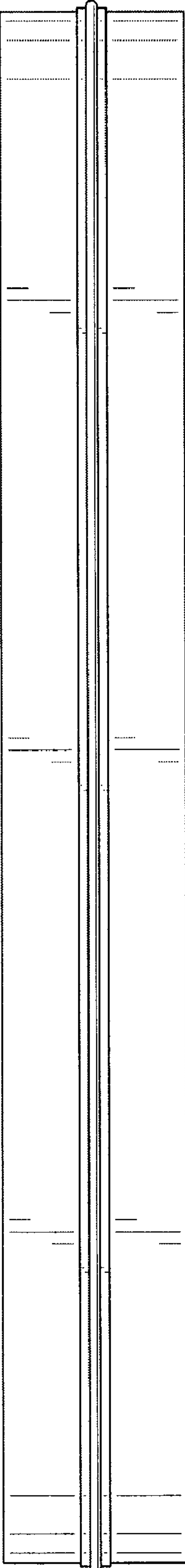

FIG. 4

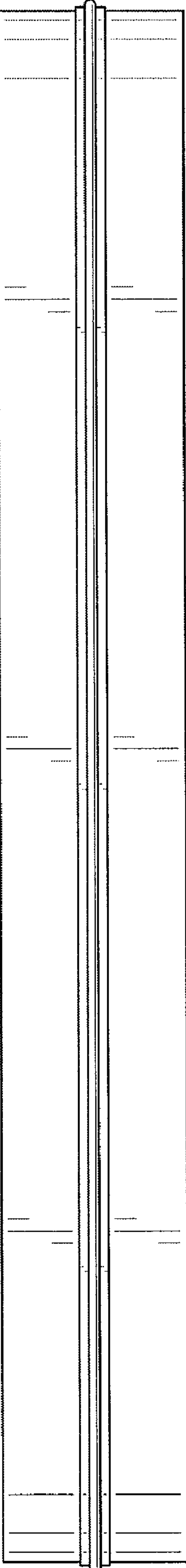

FIG. 5

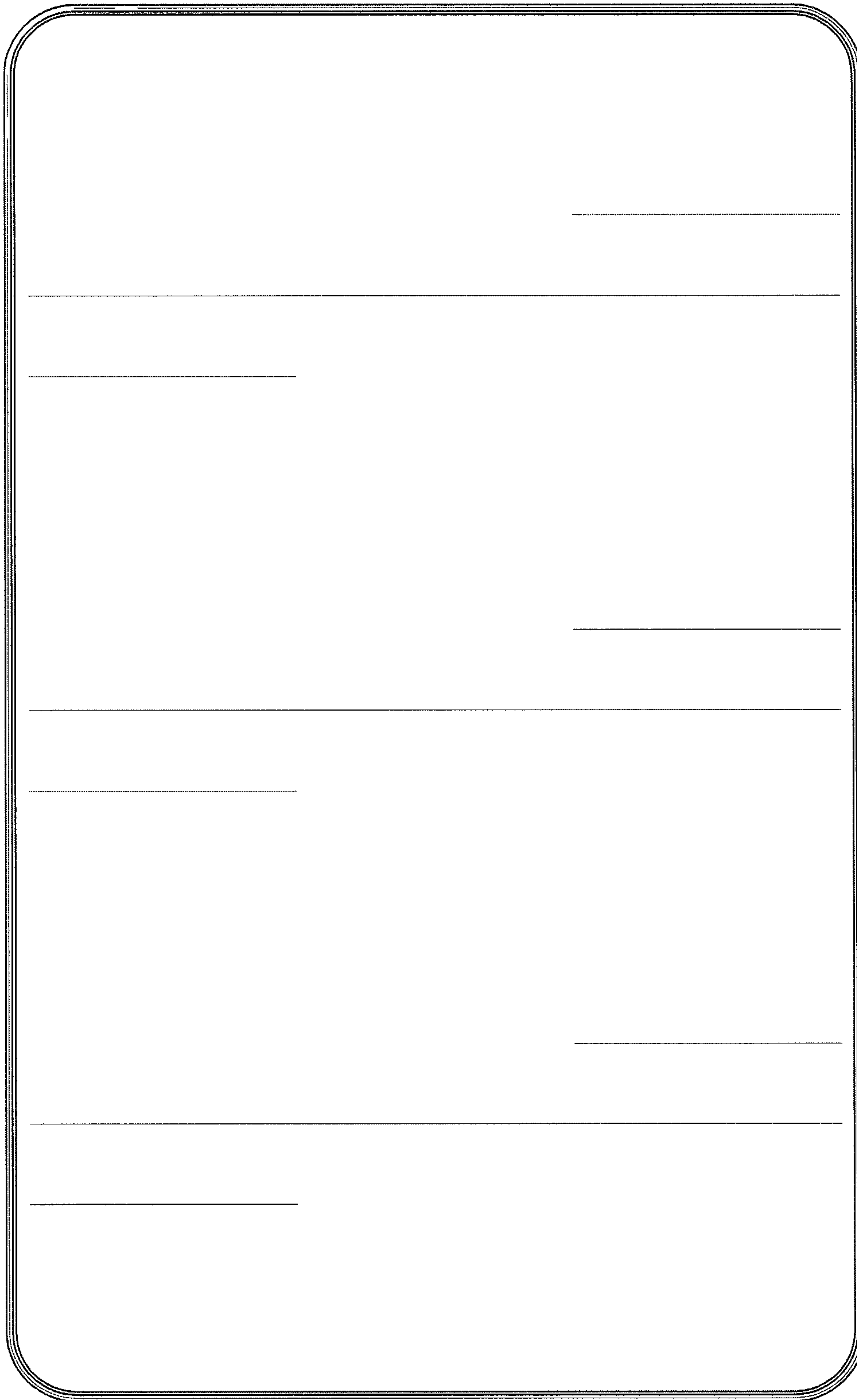

FIG. 6

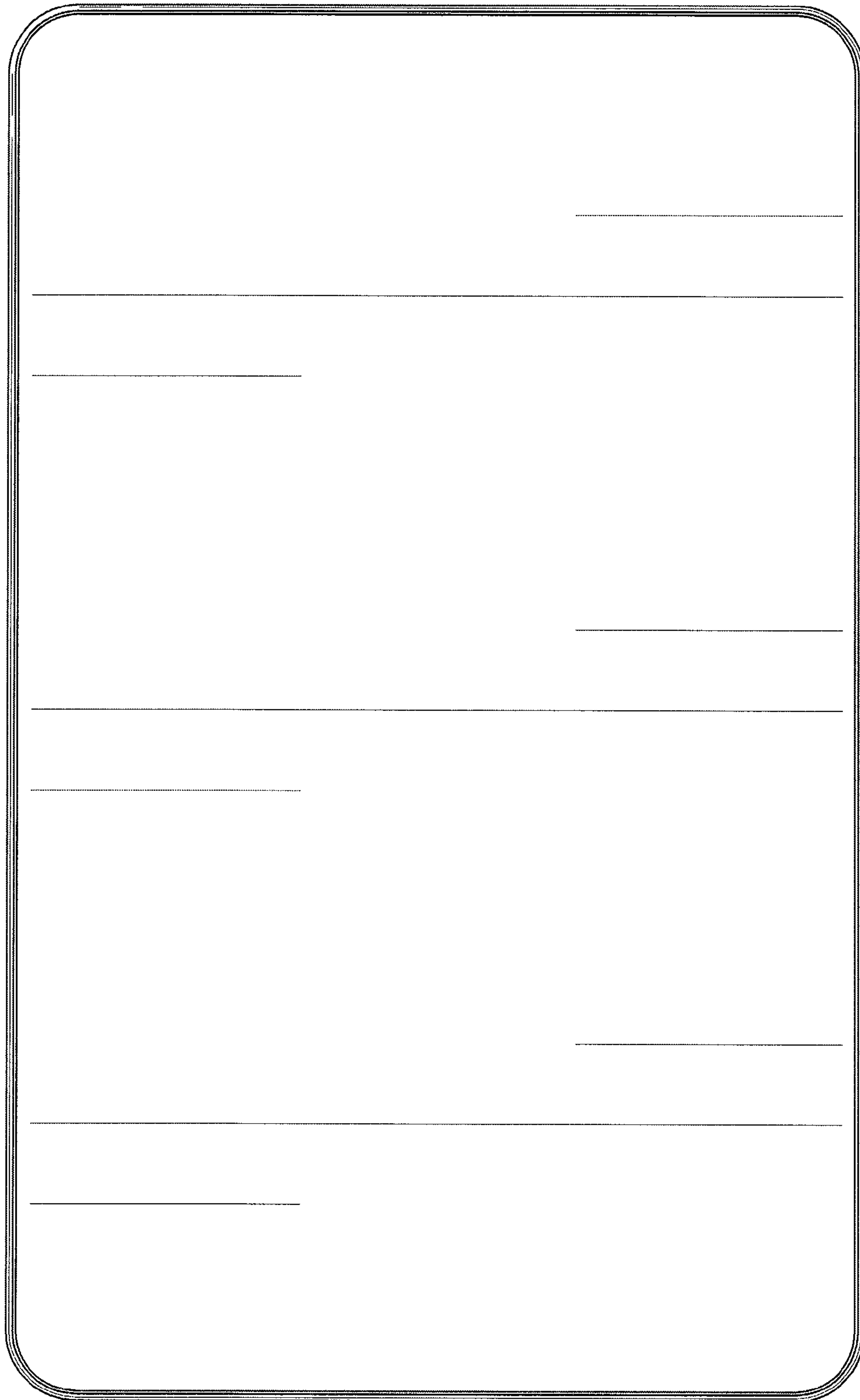

FIG. 7

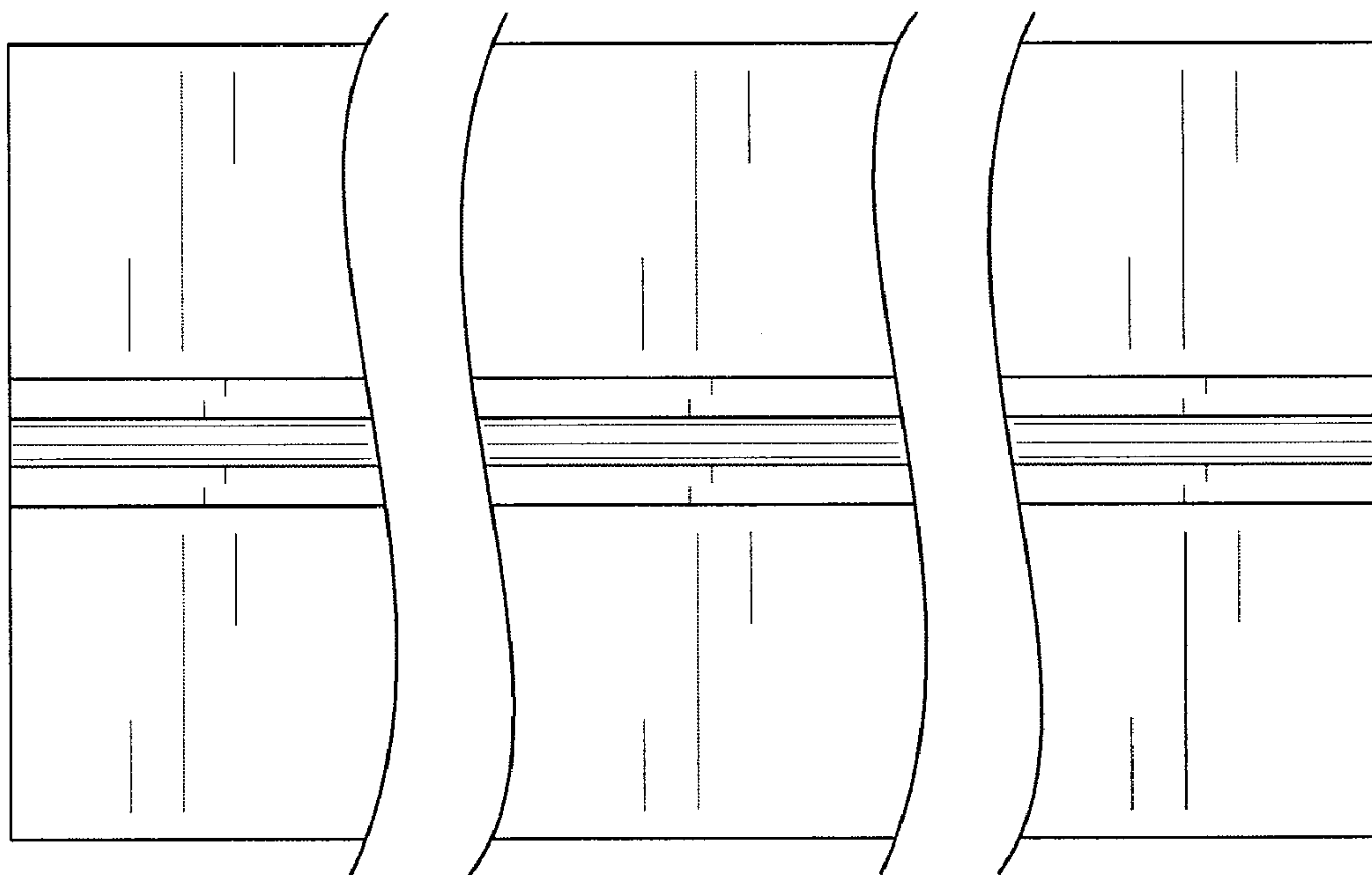

FIG. 8



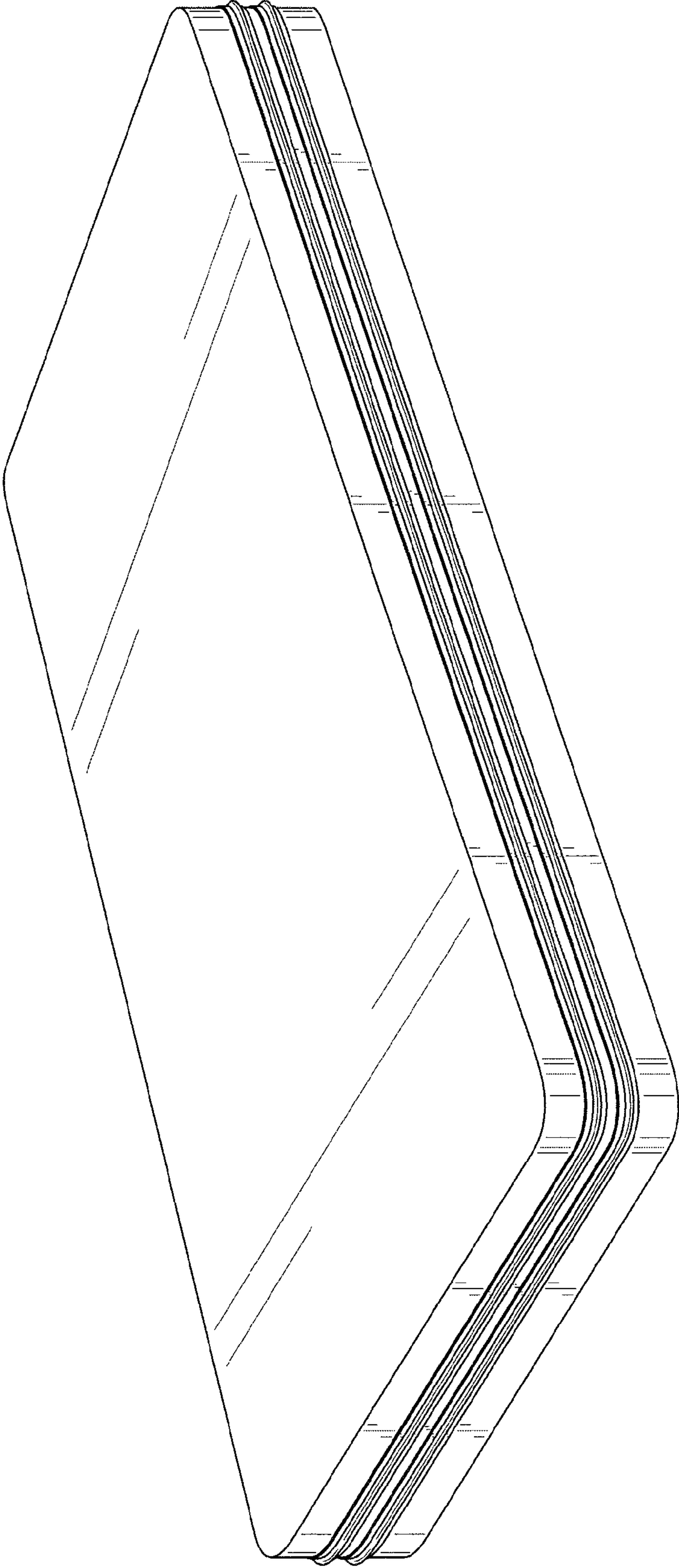

FIG. 9



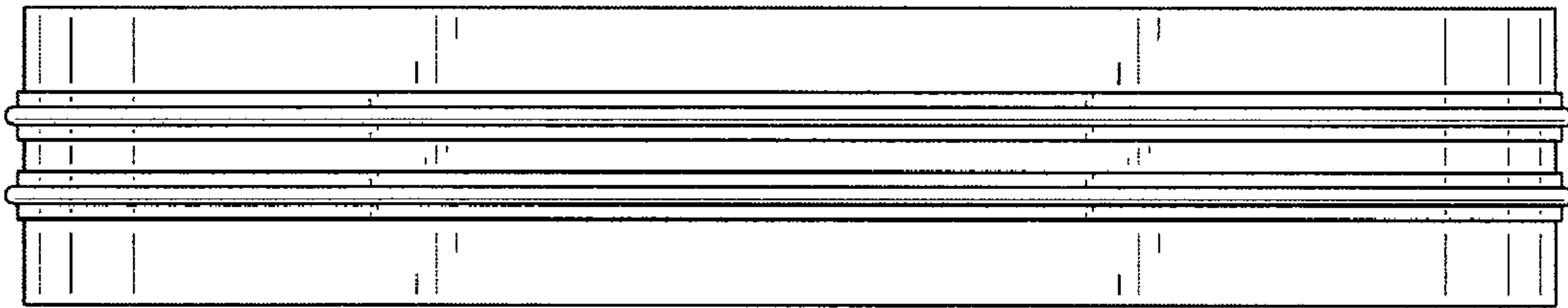

FIG. 10

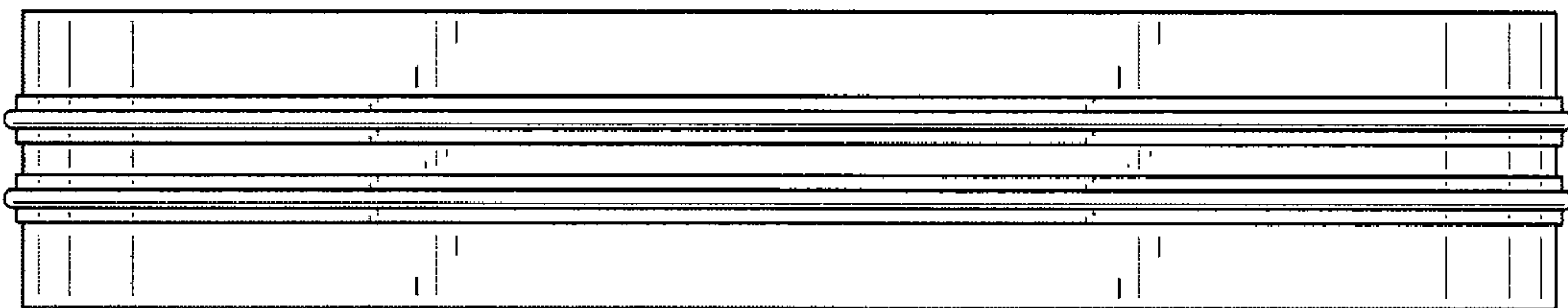

FIG. 11

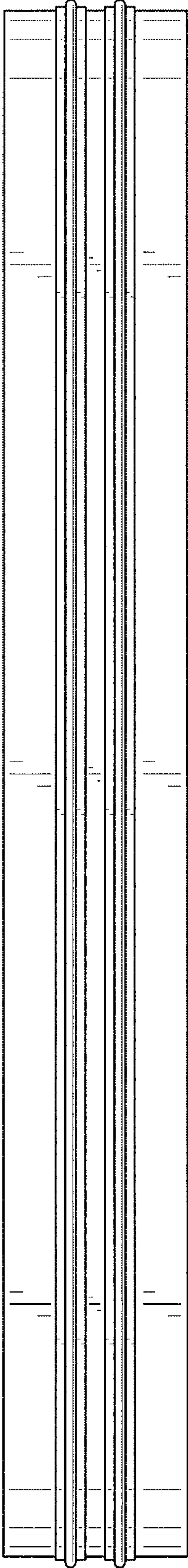

FIG. 12

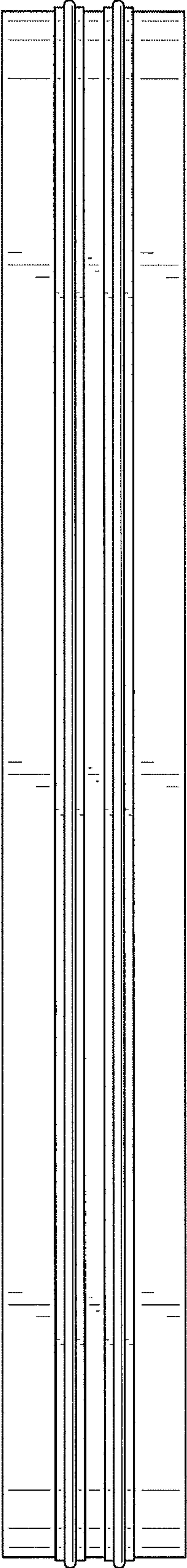

FIG. 13