



US00D670118S

(12) **United States Design Patent**
Davis

(10) **Patent No.:** **US D670,118 S**

(45) **Date of Patent:** **** Nov. 6, 2012**

(54) **ELECTRONIC KEY RECHARGING CABINET**

Primary Examiner — Brian N Vinson

(75) Inventor: **Paul R. Davis**, Corvallis, OR (US)

(74) *Attorney, Agent, or Firm* — J. Douglas Wells

(73) Assignee: **Videx, Inc.**, Corvallis, OR (US)

(**) Term: **14 Years**

(57) **CLAIM**

(21) Appl. No.: **29/426,590**

The ornamental design for an electronic key recharging cabinet, as shown and described.

(22) Filed: **Jul. 6, 2012**

Related U.S. Application Data

DESCRIPTION

(62) Division of application No. 29/388,488, filed on Mar. 29, 2011, now Pat. No. Des. 663,146.

(51) **LOC (9) Cl.** **06-04**

(52) **U.S. Cl.** **D6/559**

(58) **Field of Classification Search** D6/553,
D6/559, 560, 561, 329, 396, 442, 448, 436,
D6/437, 438, 439, 444, 445, 446, 468; 312/209,
312/234, 224, 225, 242, 245; 206/320, 823;
D8/330-331, 346; D13/107-109; D99/28;
320/107-115; 20/63, 69, 78, 80, 158, 271,
20/431, 434, 443

See application file for complete search history.

FIG. 1 is a perspective view of a first embodiment of a key cabinet, showing my new design;

FIG. 2 is a front elevation view of the key cabinet shown in FIG. 1;

FIG. 3 is a rear elevation view of the key cabinet shown in FIG. 1;

FIG. 4 is a top plan view of the key cabinet shown in FIG. 1;

FIG. 5 is a bottom plan view of the key cabinet shown in FIG. 1;

FIG. 6 is a left side view of the key cabinet shown in FIG. 1;

FIG. 7 is a right side view of the key cabinet shown in FIG. 1;

and,
FIG. 8 is a perspective view of a second embodiment of a key cabinet, showing my new design, wherein the shaded areas represent a contrasted color of a key cabinet, the contrasted color not representing a specific color or color combination, wherein the front elevation view and rear elevation, plan, and side views not shown are substantially disclosed and similar to those shown for the embodiment in FIG. 1.

The broken-line disclosure in the views is understood to represent portions of the article in which the claimed design is embodied, but which form no part of the claimed design.

(56) **References Cited**

U.S. PATENT DOCUMENTS

D266,199	S	*	9/1982	Schattner et al.	D99/28
D297,195	S	*	8/1988	Warwicker	D6/559
D484,725	S	*	1/2004	Howard	D6/559
D495,234	S	*	8/2004	Fisher et al.	D8/330
D500,224	S	*	12/2004	Drehs	D6/559
D582,254	S	*	12/2008	Turpault et al.	D8/346
D635,377	S	*	4/2011	Rodgers et al.	D6/468
D638,020	S	*	5/2011	Johnson et al.	D13/107
D642,556	S	*	8/2011	Lee	D13/108

* cited by examiner

1 Claim, 8 Drawing Sheets

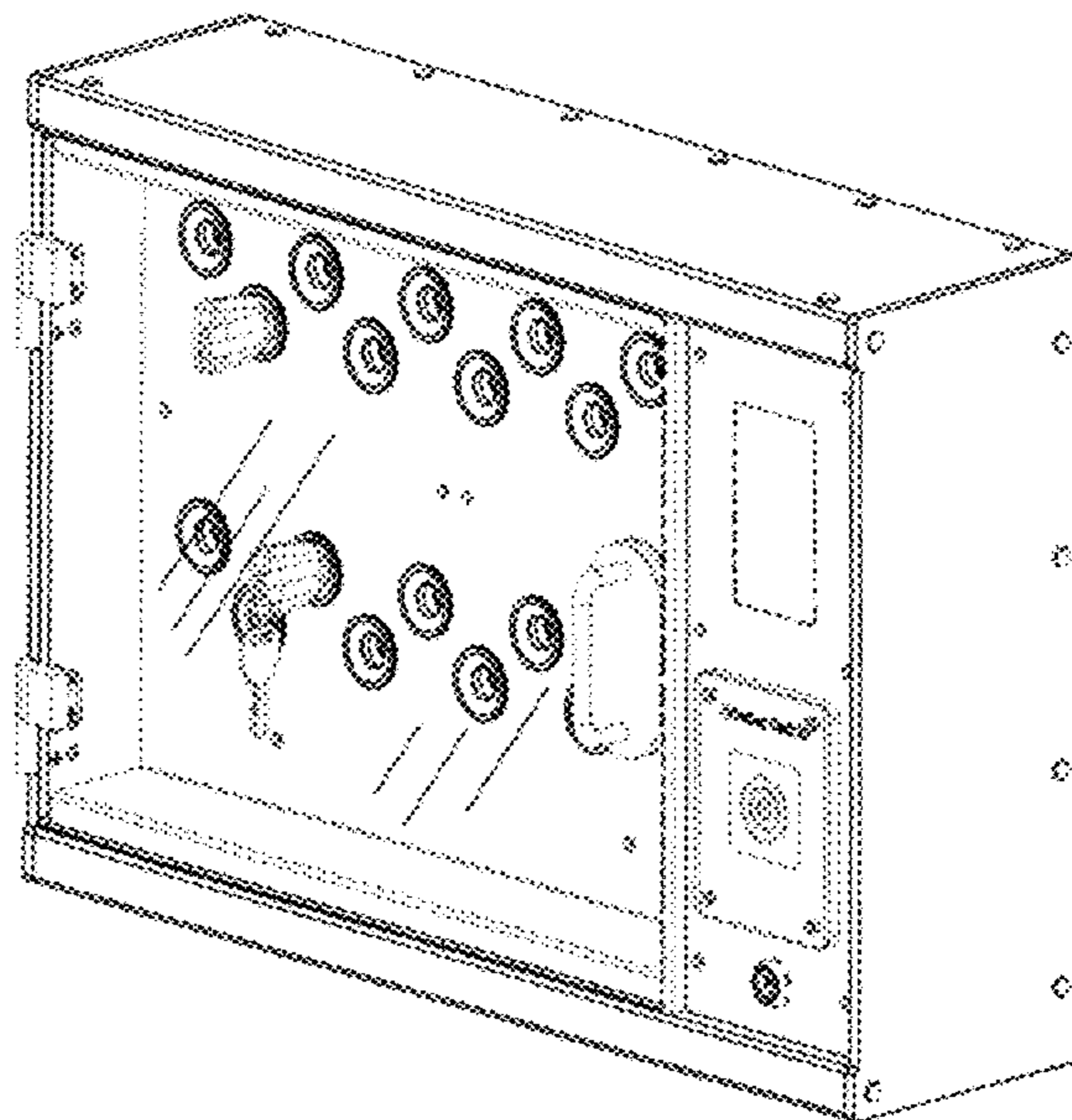

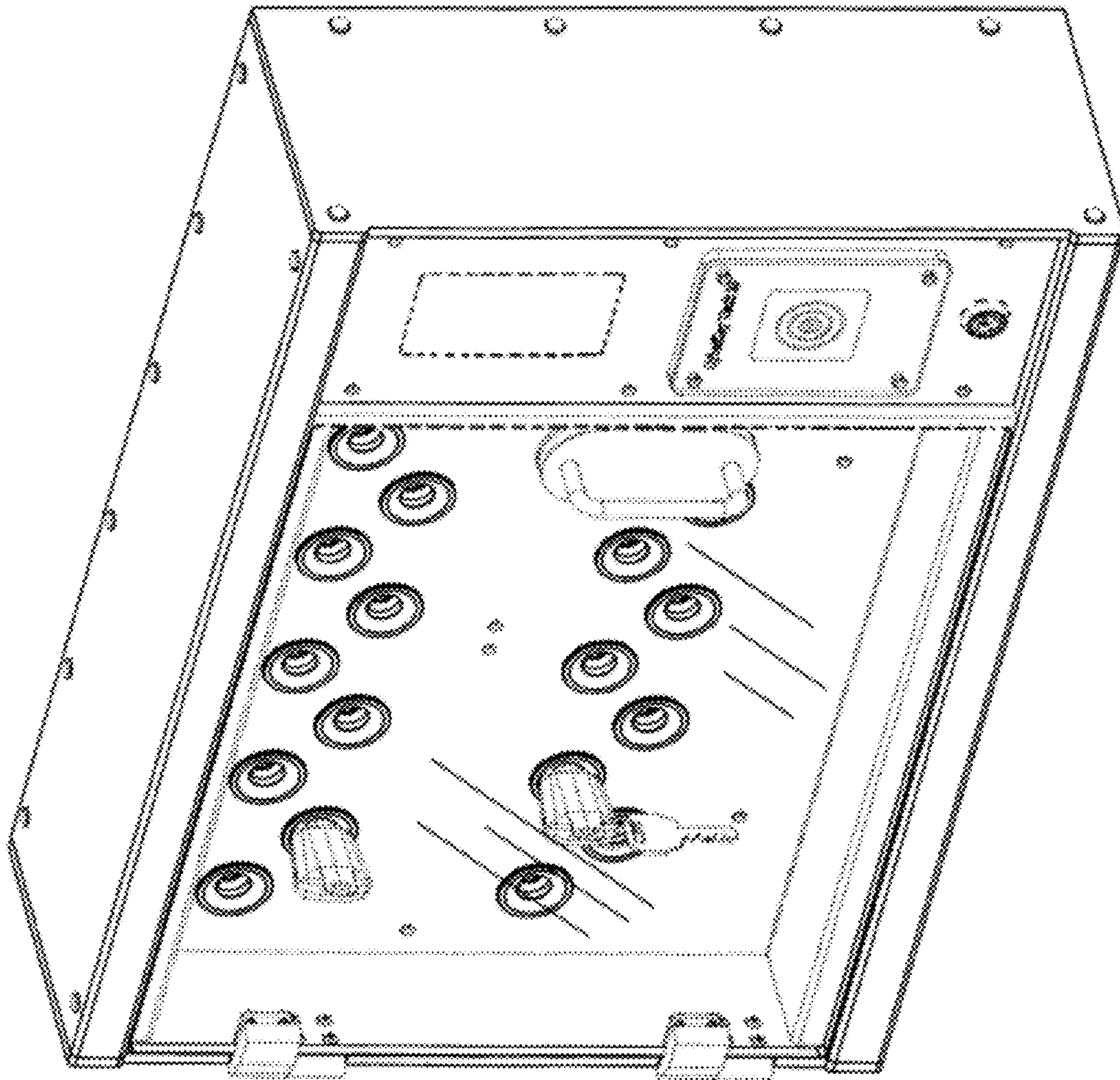

FIG. 1

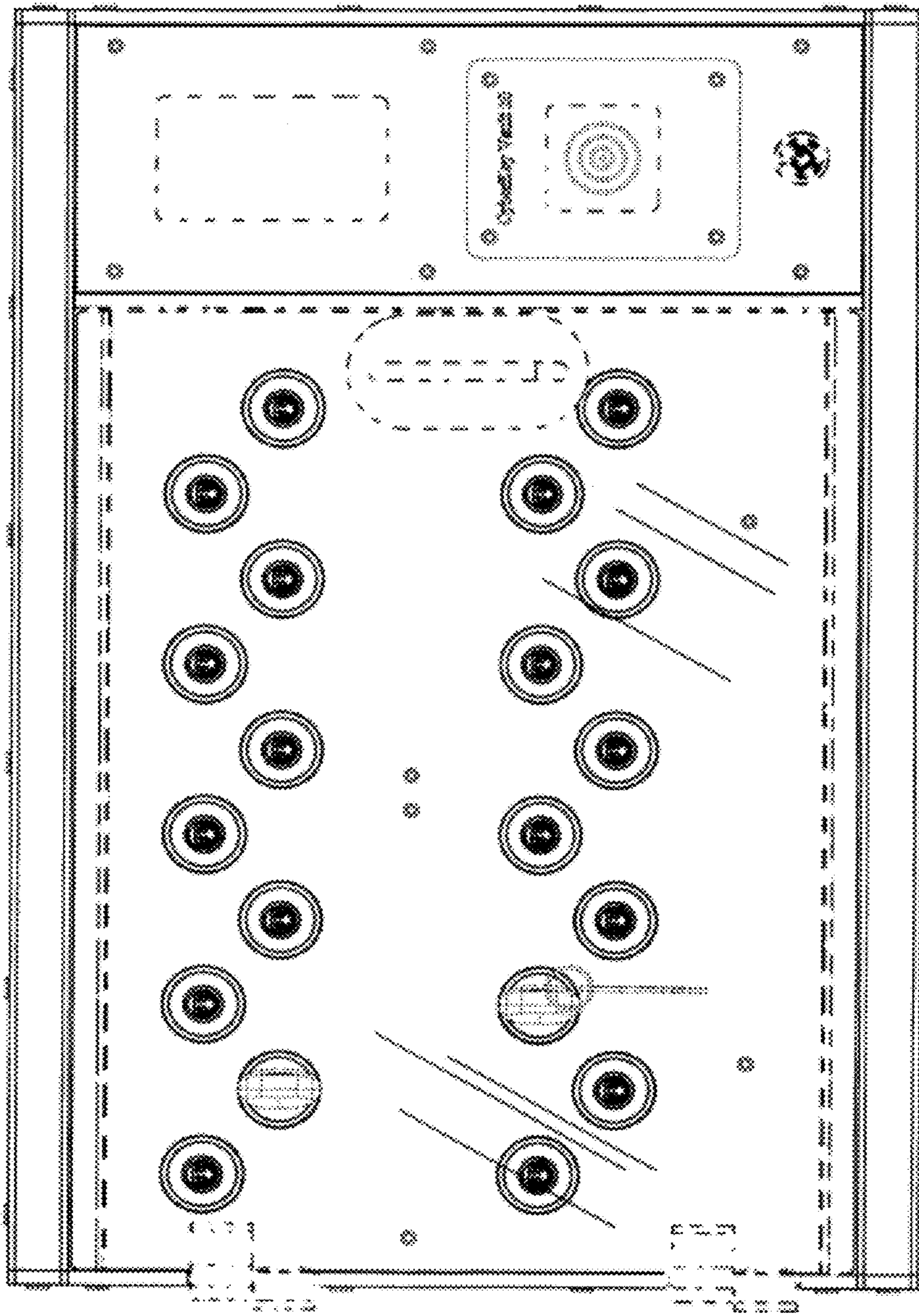

Fig. 2

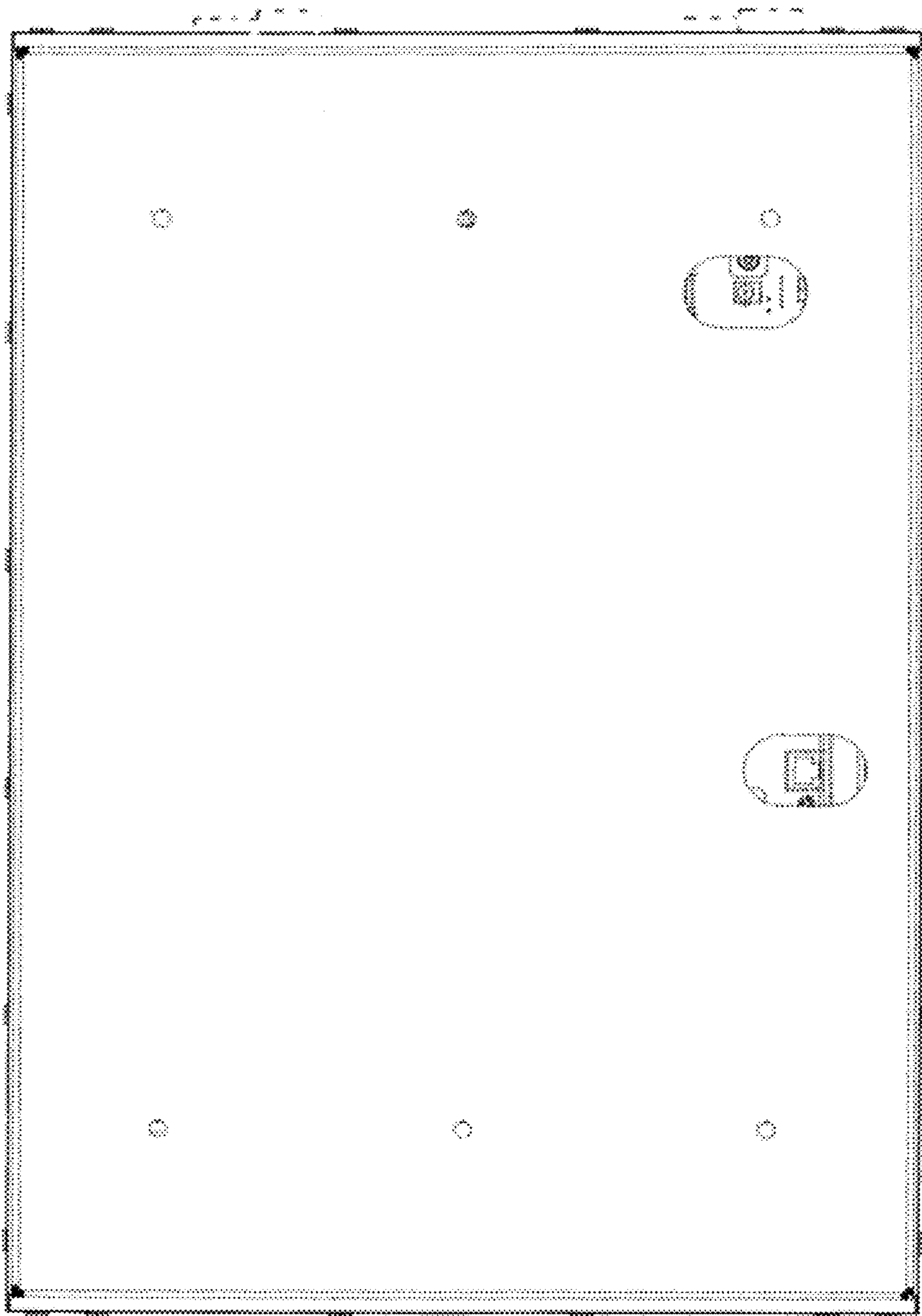

Fig. 3

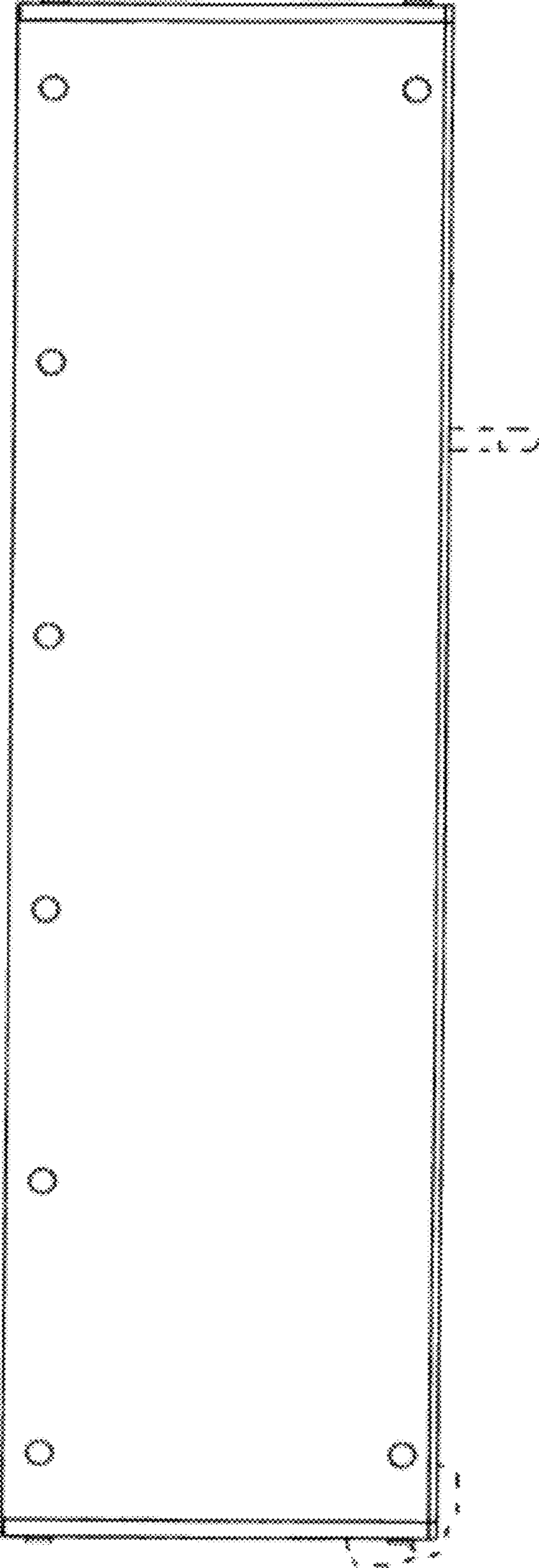

FIG. 4

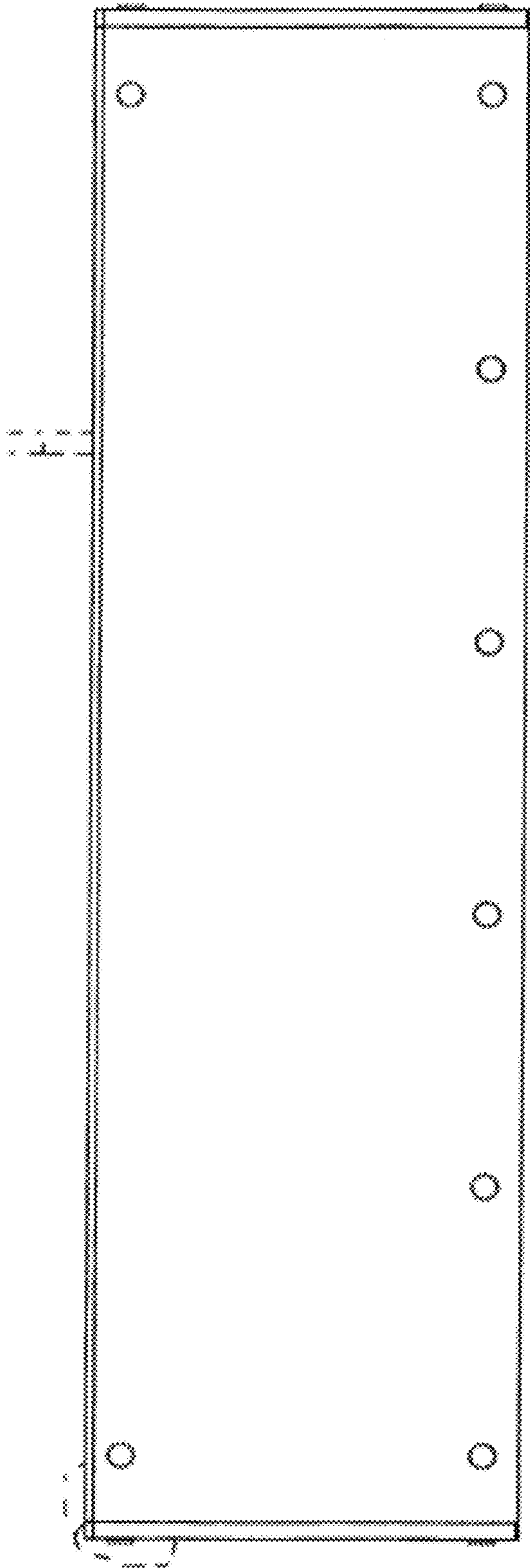

Fig. 5

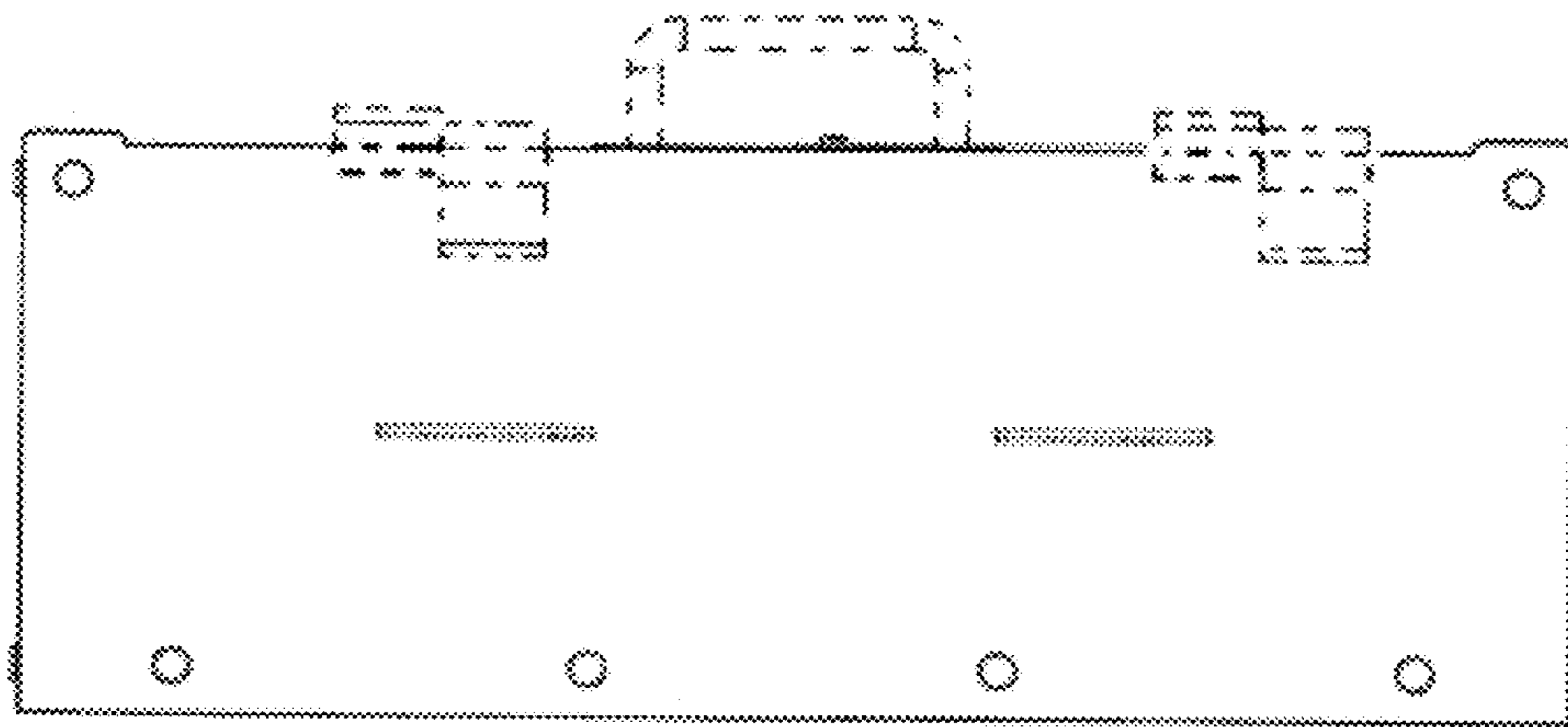

FIG. 6

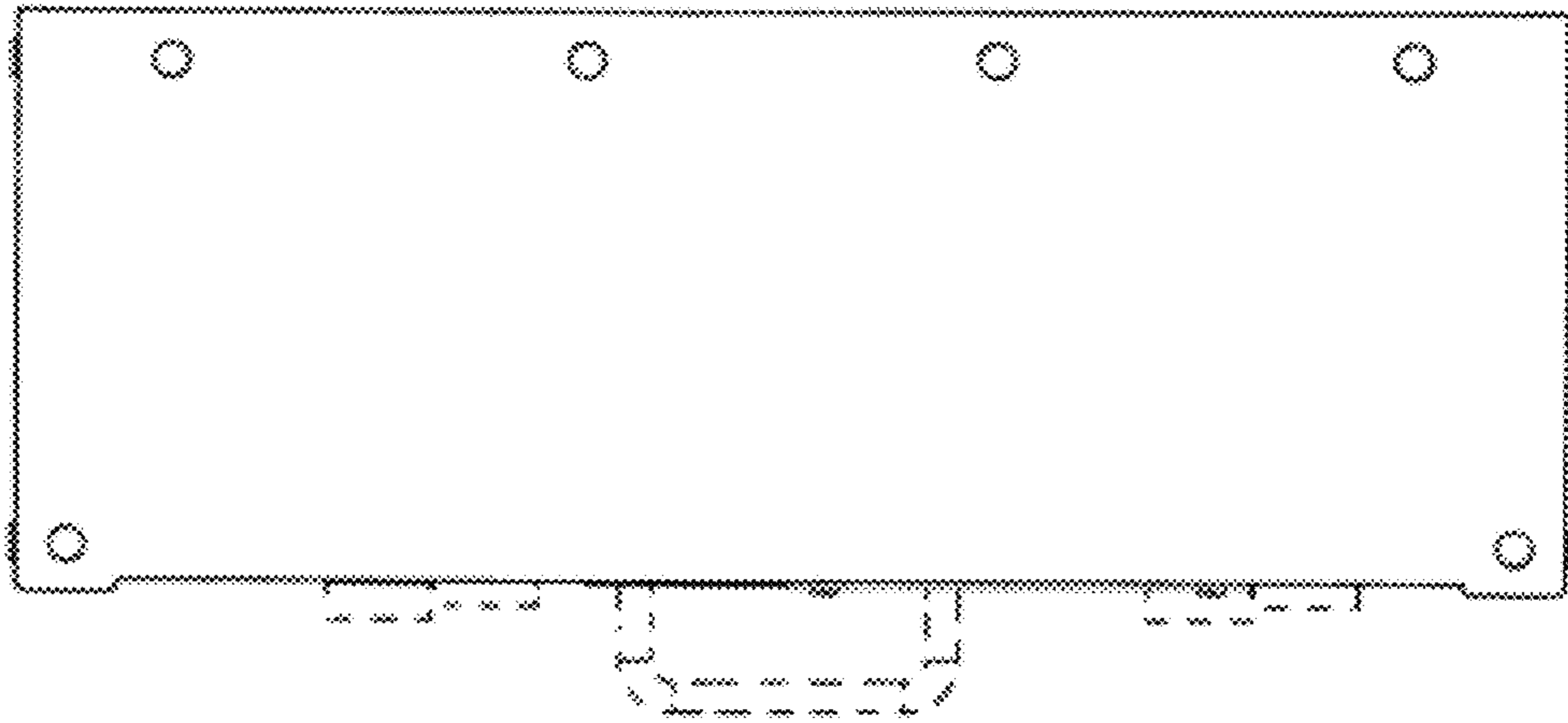

FIG. 7

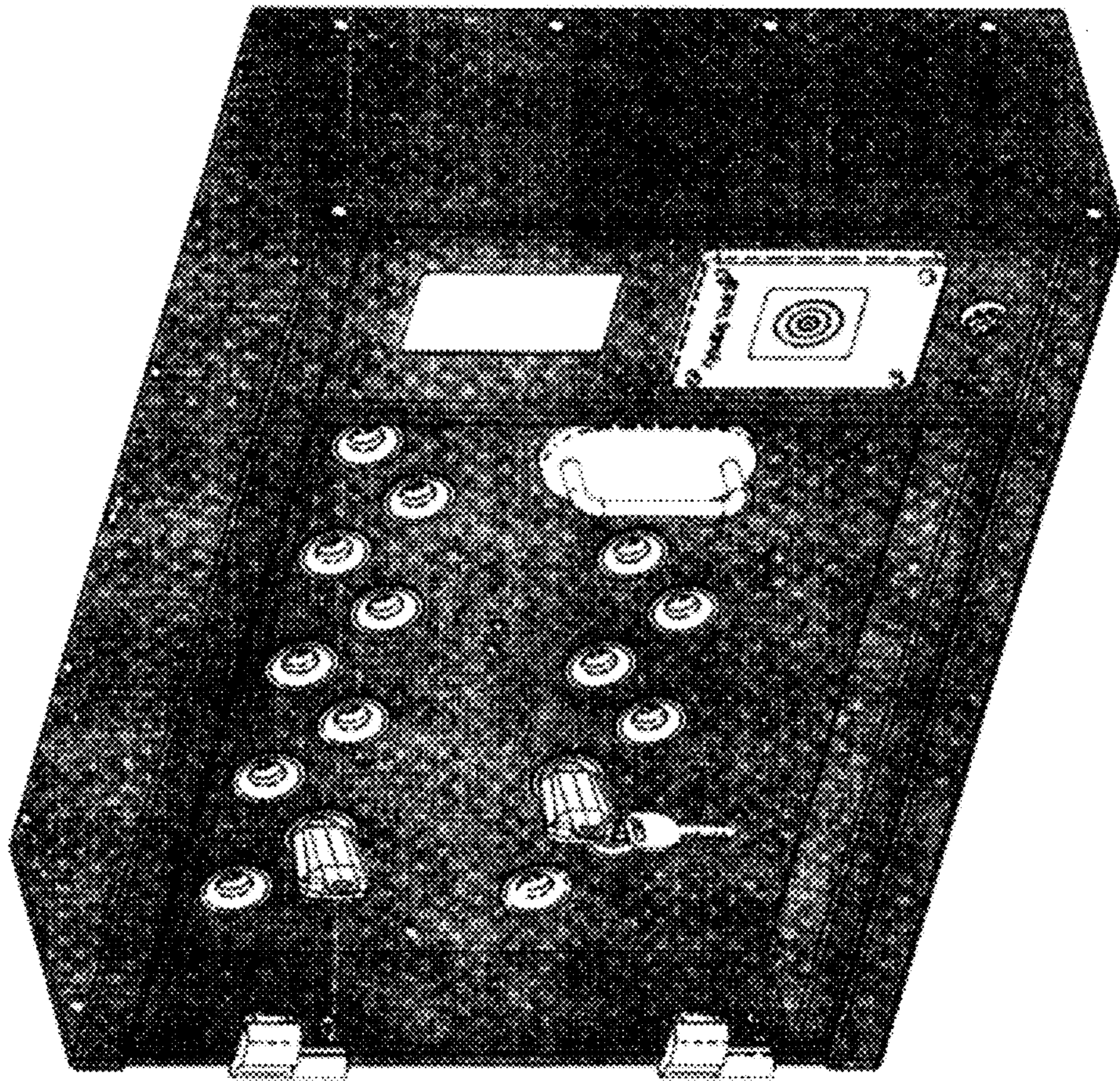

Fig. 8