

US00D669958S

(12) **United States Design Patent**
Essig et al.

(10) **Patent No.:** **US D669,958 S**
(45) **Date of Patent:** **** Oct. 30, 2012**

(54) **LASER DEVICE**

(75) Inventors: **Drew Essig**, Wilsonville, OR (US);
Frederick Karl, Wilsonville, OR (US)

(73) Assignee: **Crimson Trace, Inc.**, Wilsonville, OR
(US)

(**) Term: **14 Years**

(21) Appl. No.: **29/391,573**

(22) Filed: **May 10, 2011**

(51) **LOC (9) Cl.** **22-01**

(52) **U.S. Cl.** **D22/108**

(58) **Field of Classification Search** D22/108–110,
D22/199; 89/111–133; 359/399, 409–411,
359/823, 744; 42/104, 105, 111–113, 116,
42/120, 124–126, 127–129, 141–148, 133–140;
33/227, 229; D16/130–136; D26/38–39
See application file for complete search history.

(56) **References Cited**

U.S. PATENT DOCUMENTS

4,856,218	A *	8/1989	Reynolds, Jr.	42/146
5,107,612	A *	4/1992	Bechtel	42/115
5,430,967	A *	7/1995	Woodman et al.	42/114
5,435,091	A	7/1995	Toole et al.	
5,485,695	A *	1/1996	Glock	42/117
5,581,898	A *	12/1996	Thummel	42/117
5,706,600	A *	1/1998	Toole et al.	42/115
5,784,823	A *	7/1998	Chen	42/115
6,393,752	B1 *	5/2002	Oliver et al.	42/114
6,571,503	B2 *	6/2003	Thorpe	42/114

7,260,910	B2	8/2007	Danielson	
7,472,830	B2	1/2009	Danielson	
D603,478	S *	11/2009	Hughes	D22/110
D612,756	S *	3/2010	D'Amelio et al.	D10/70
D616,957	S	6/2010	Rievley et al.	
7,743,547	B2	6/2010	Houde-Walter	
7,805,876	B1	10/2010	Danielson et al.	
D636,049	S *	4/2011	Hughes et al.	D22/109
D636,837	S *	4/2011	Hughes et al.	D22/109
8,028,461	B2	10/2011	NuDyke	
2011/0047850	A1	3/2011	Rievley et al.	

* cited by examiner

Primary Examiner — Michael A Pratt

(74) *Attorney, Agent, or Firm* — Schwabe, Williamson & Wyatt, P.C.

(57) **CLAIM**

We claim an ornamental design for a laser device, as shown and described.

DESCRIPTION

FIG. 1 is a perspective view of a laser device, showing my new design;

FIG. 2 is a front view thereof;

FIG. 3 is a rear view thereof;

FIG. 4 is a right side view thereof;

FIG. 5 is a left side view thereof;

FIG. 6 is a top view thereof;

FIG. 7 is a bottom view thereof; and,

FIG. 8 is a side perspective view thereof.

The dashed lines are included for illustrating interior and/or environmental structures and form no part of the claimed design.

1 Claim, 7 Drawing Sheets

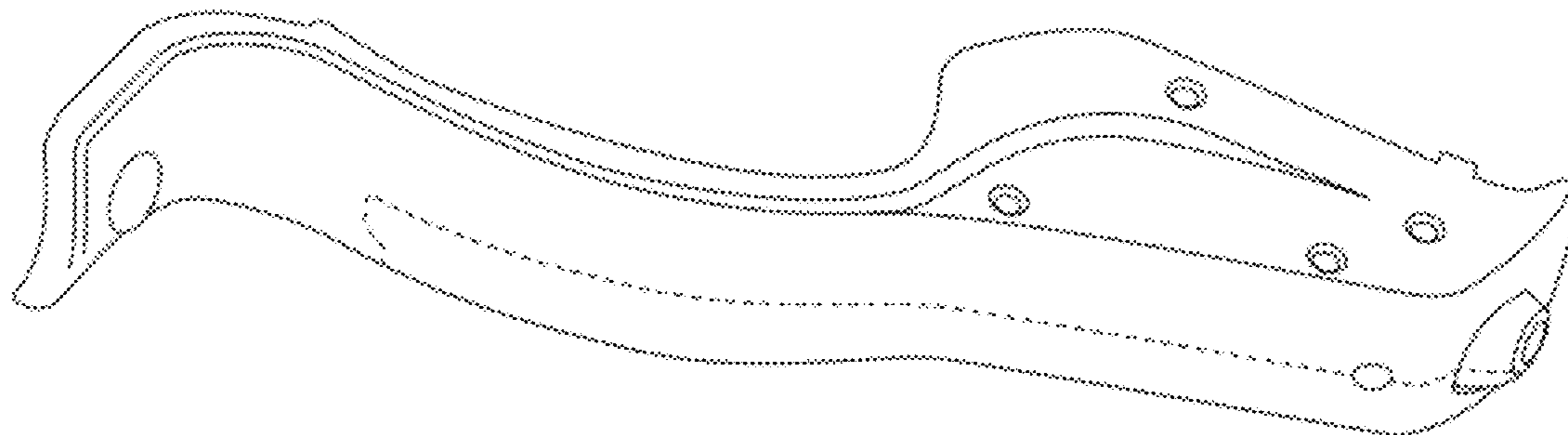

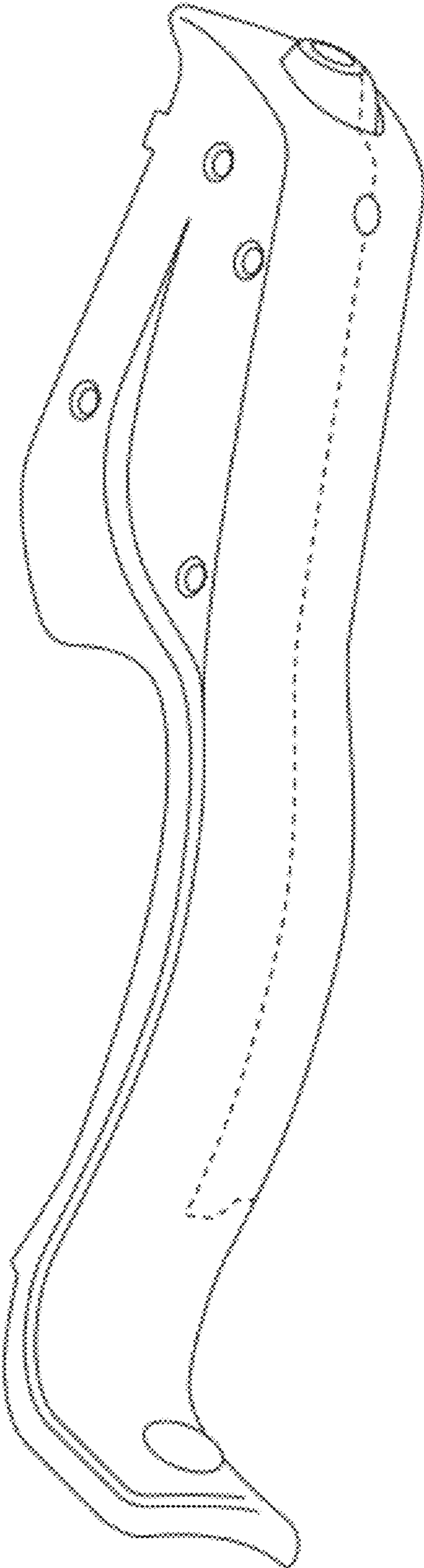

FIG. 1

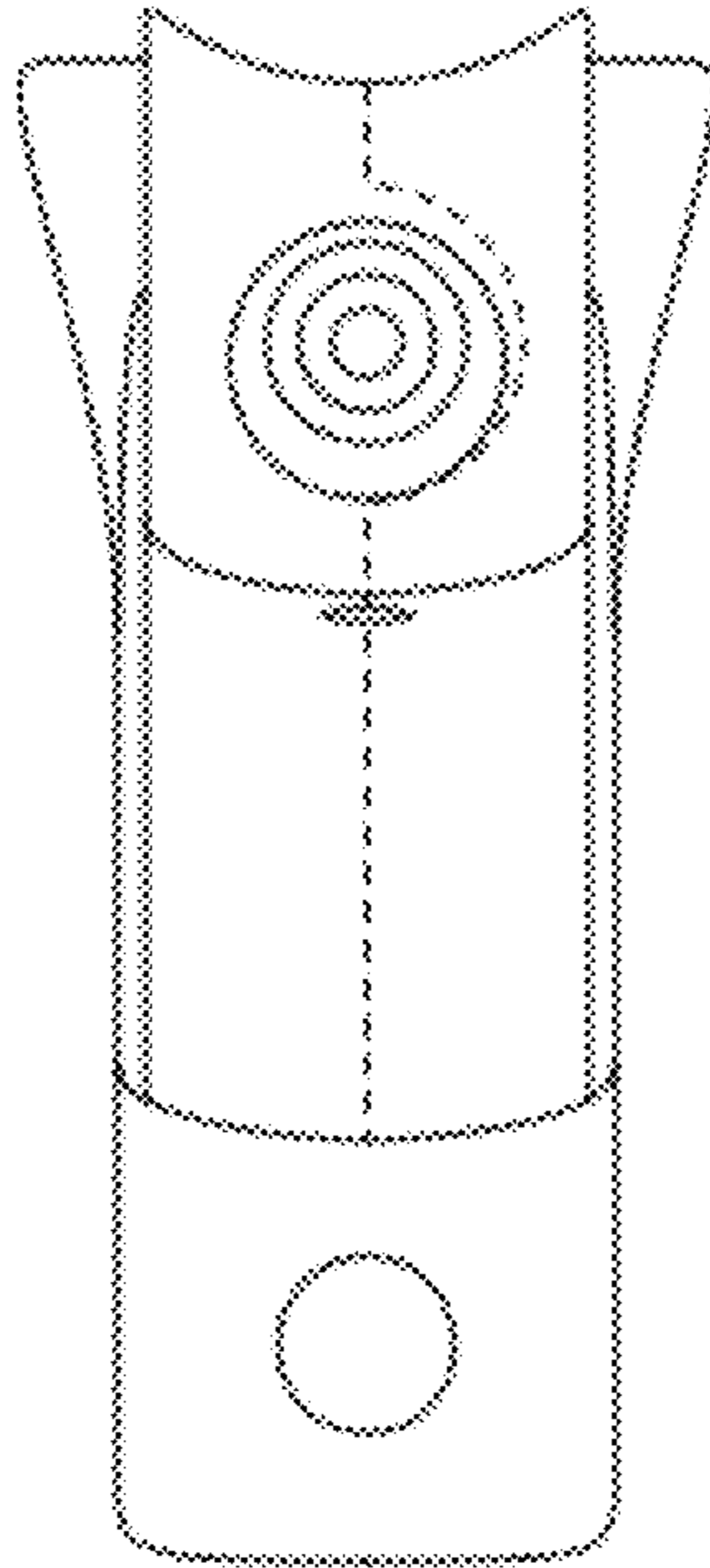

FIG. 2

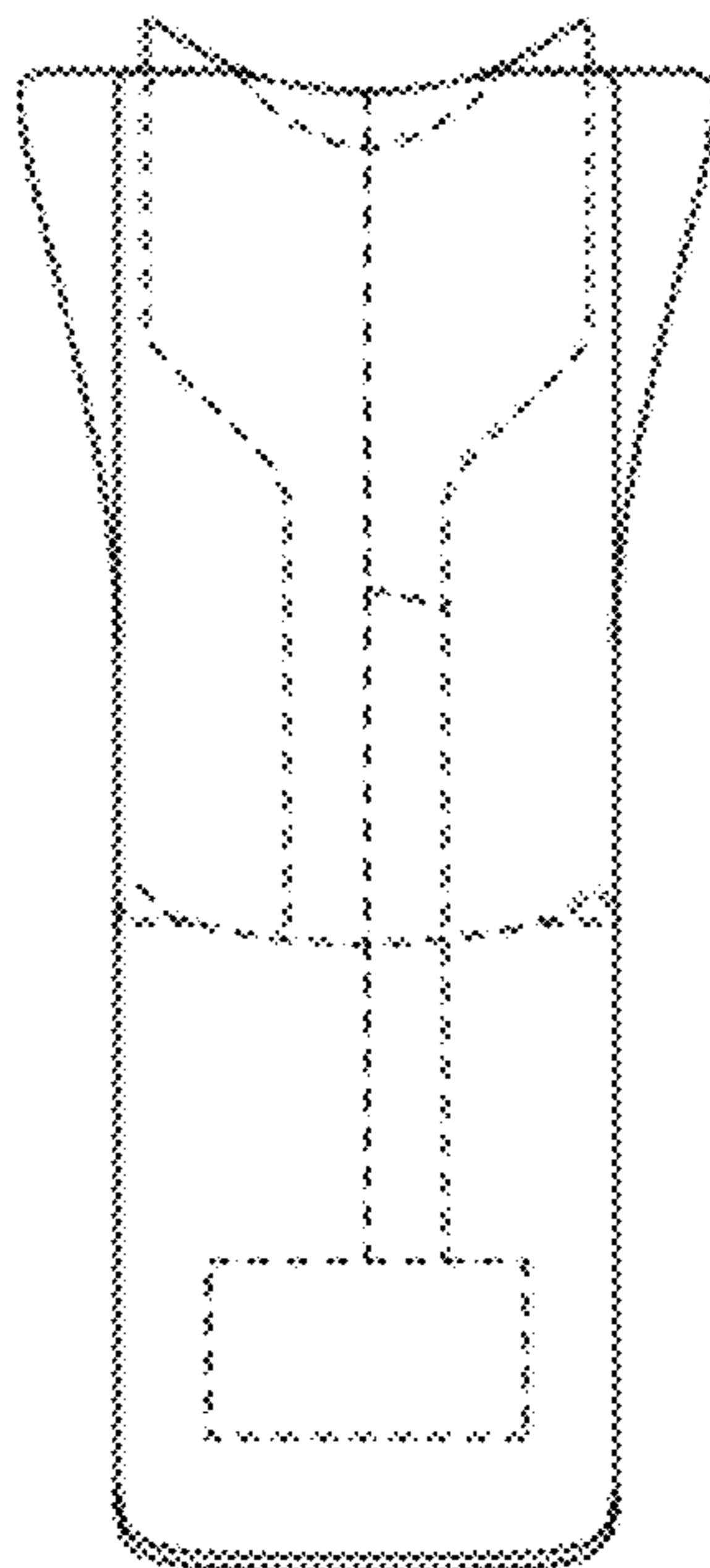

FIG. 3

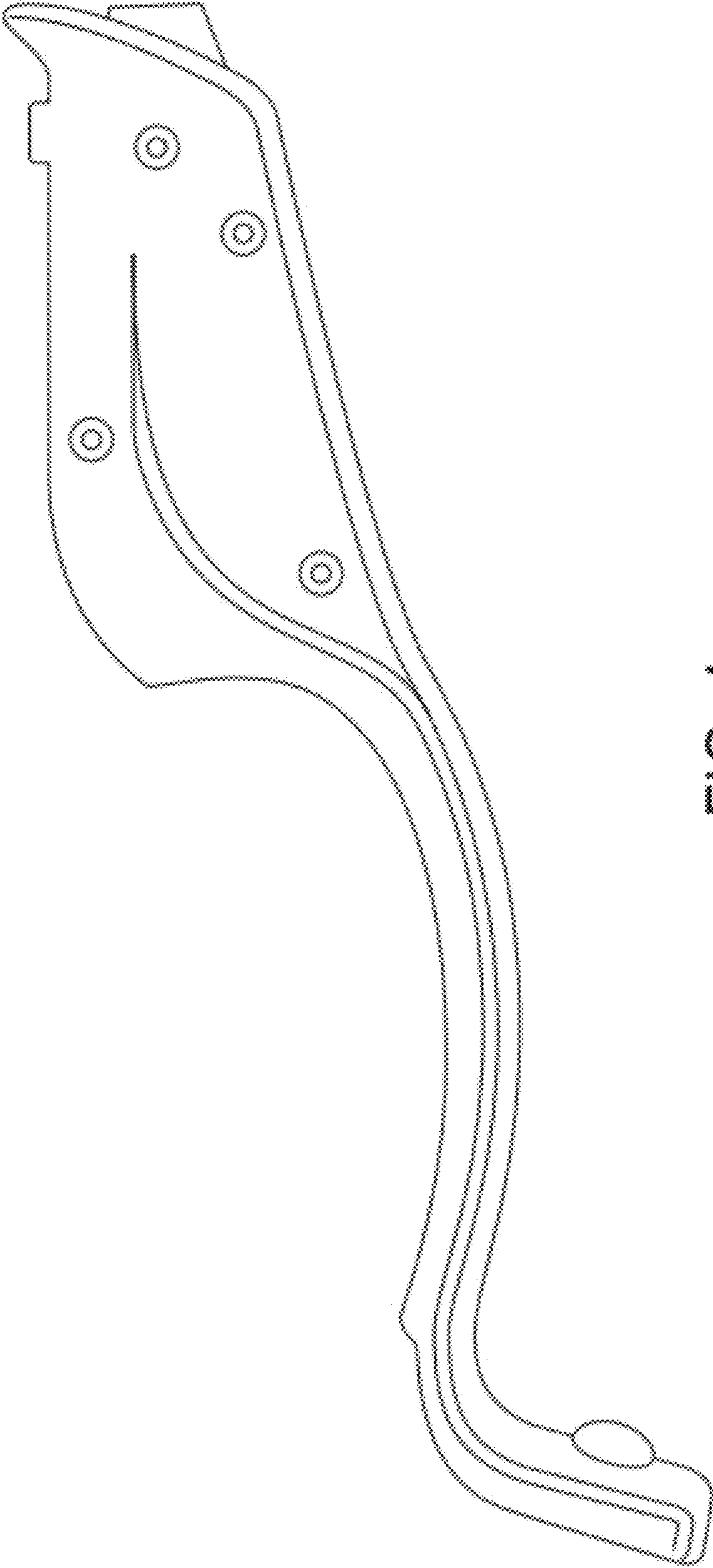

FIG. 4

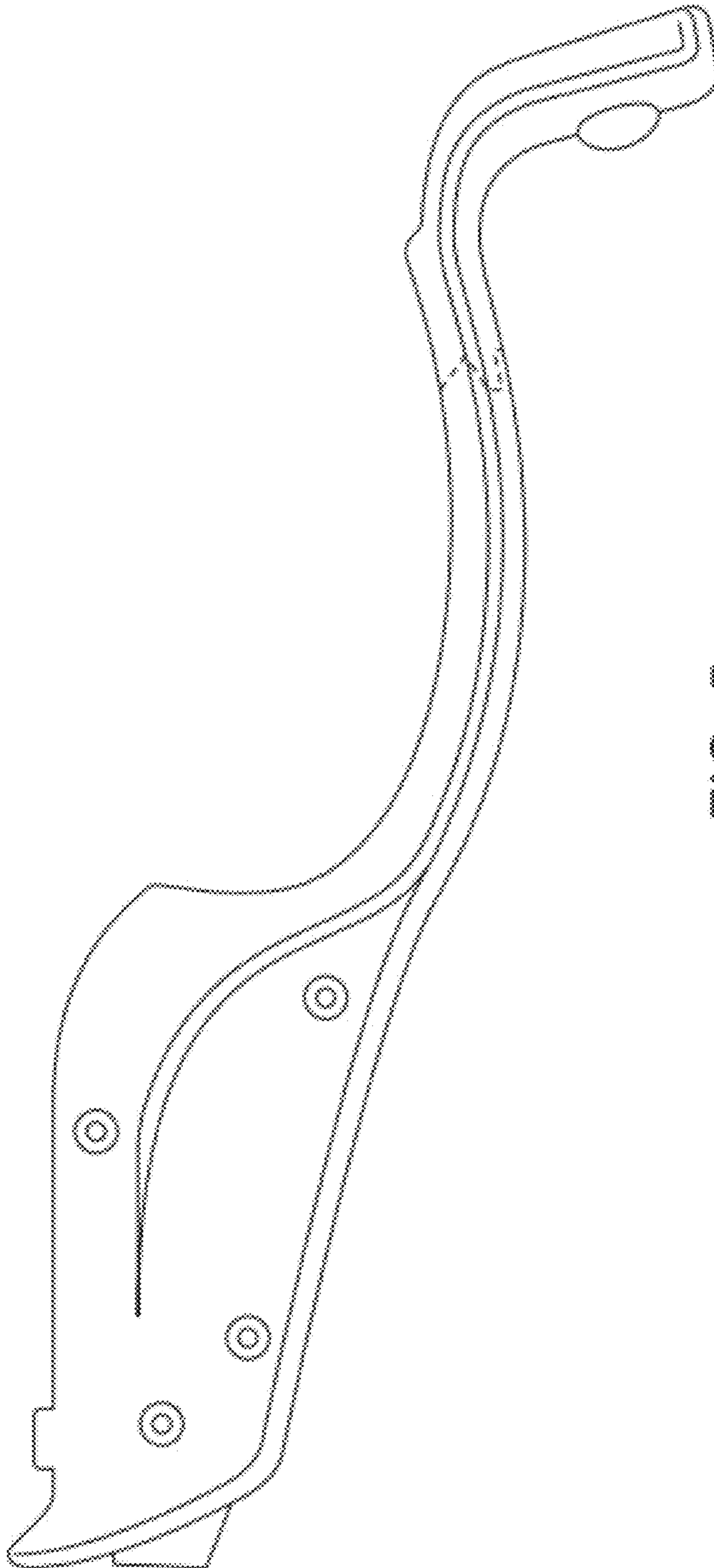

FIG. 5

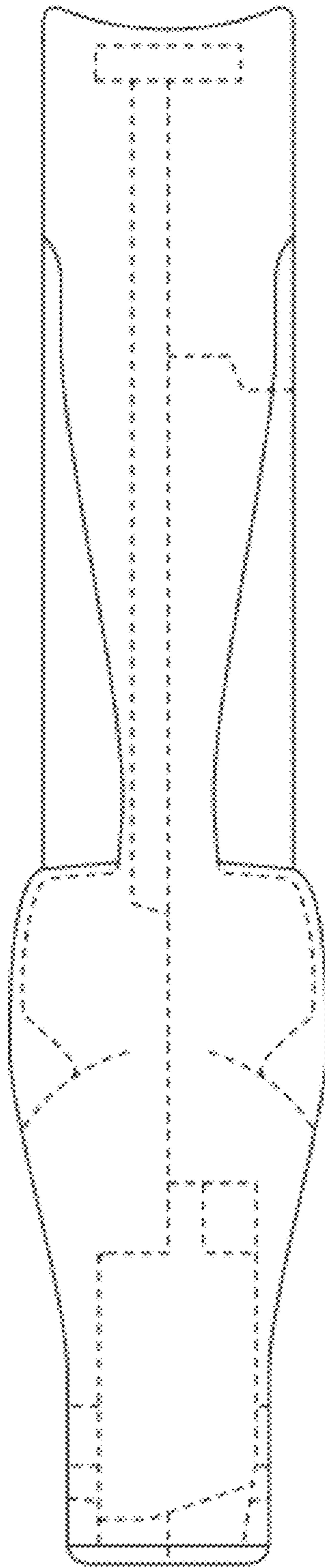

FIG. 6

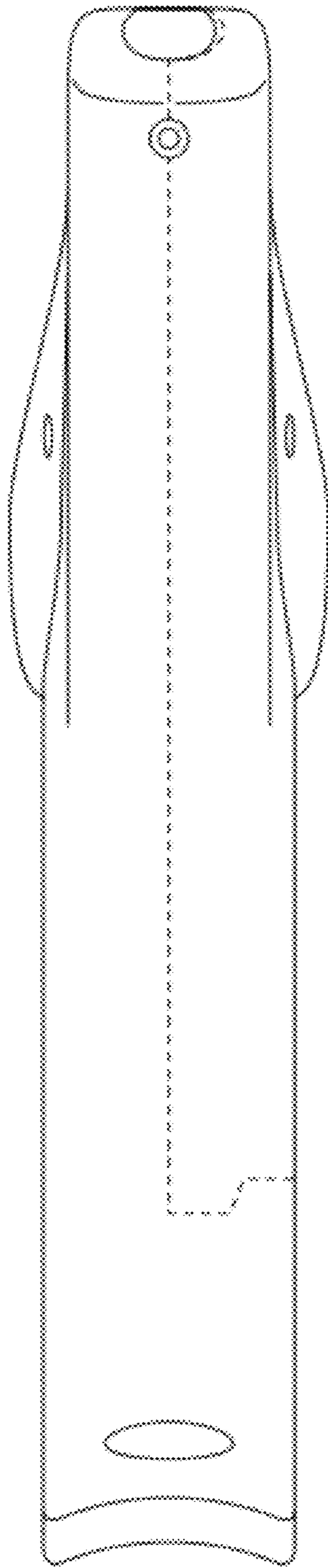

FIG. 7

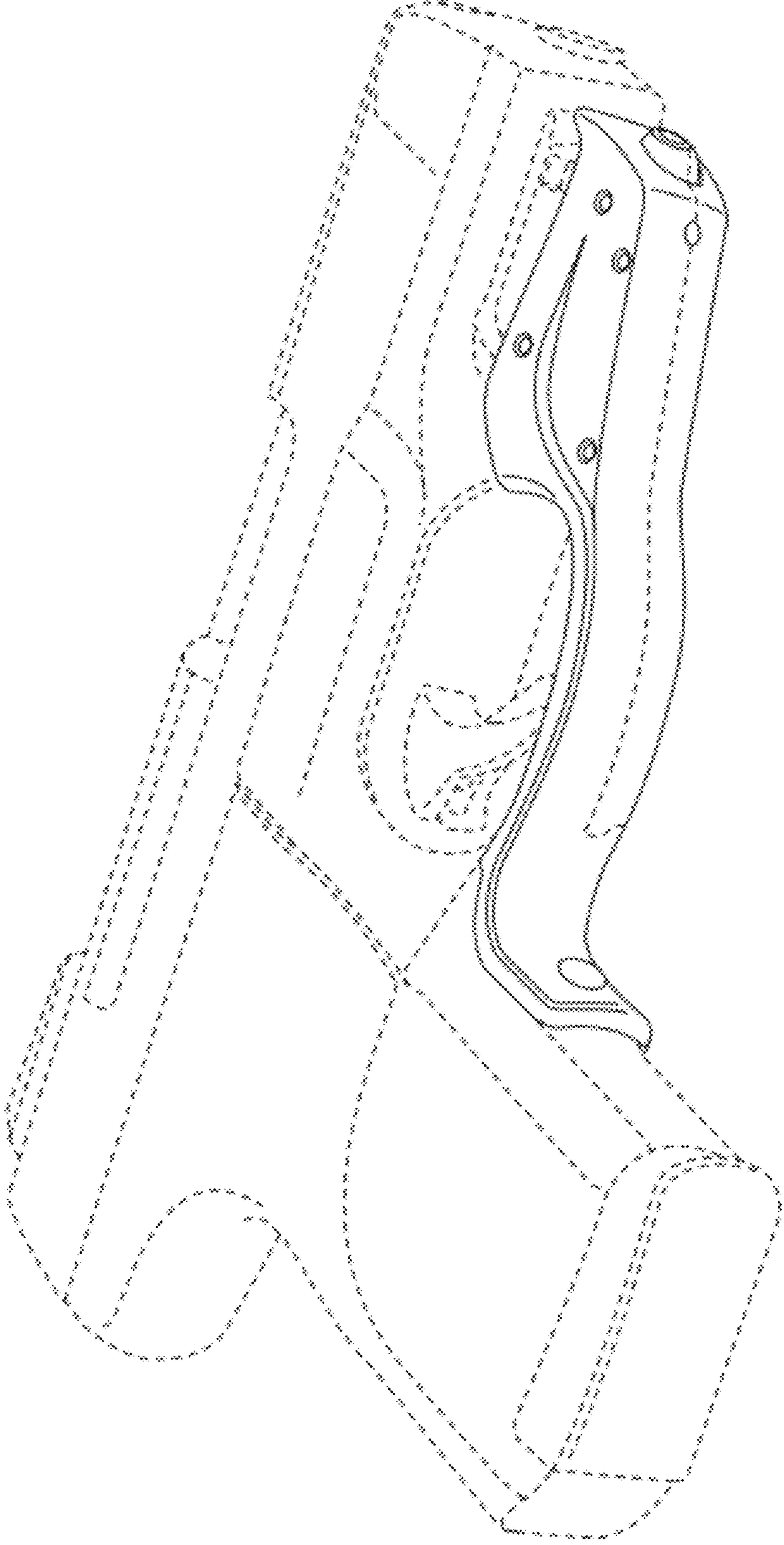

FIG. 8