



US00D669952S

(12) **United States Design Patent**
Zwart

(10) **Patent No.:** **US D669,952 S**

(45) **Date of Patent:** **** Oct. 30, 2012**

(54) **GOLF DIVOT REPAIR TOOL**

(76) Inventor: **Michel Zwart**, Haarlem (NL)

(**) Term: **14 Years**

(21) Appl. No.: **29/408,849**

(22) Filed: **Dec. 16, 2011**

(51) **LOC (9) Cl.** **21-02**

(52) **U.S. Cl.** **D21/793**

(58) **Field of Classification Search** D21/789,
D21/793; 473/286, 408; 30/161, 155; 7/118;
D8/105-106

See application file for complete search history.

(56) **References Cited**

U.S. PATENT DOCUMENTS

5,405,133	A *	4/1995	Upton	473/408
6,162,137	A *	12/2000	Jones et al.	473/408
D471,944	S *	3/2003	Freitas et al.	D21/793
6,800,042	B2 *	10/2004	Braithwaite	473/408
D500,828	S *	1/2005	Pace	D21/793

6,837,807	B1 *	1/2005	Kerr	473/408
D570,946	S *	6/2008	Oas	D21/793
D651,272	S *	12/2011	Corcoran et al.	D21/793

* cited by examiner

Primary Examiner — Mitchell Siegel

(74) *Attorney, Agent, or Firm* — Daniel Law Offices, P.A.;
Jason T. Daniel, Esq.

(57) **CLAIM**

The ornamental design for a golf divot repair tool, as shown.

DESCRIPTION

FIG. 1 is a perspective view thereof in a closed position,
FIG. 2 is a front side elevational view thereof,
FIG. 3 is a back side elevational view thereof,
FIG. 4 is a top side elevational view thereof,
FIG. 5 is a bottom side elevational view thereof,
FIG. 6 is a left side elevational view thereof,
FIG. 7 is a right side elevational view thereof; and,
FIG. 8 is a perspective view thereof in an open position.

1 Claim, 4 Drawing Sheets

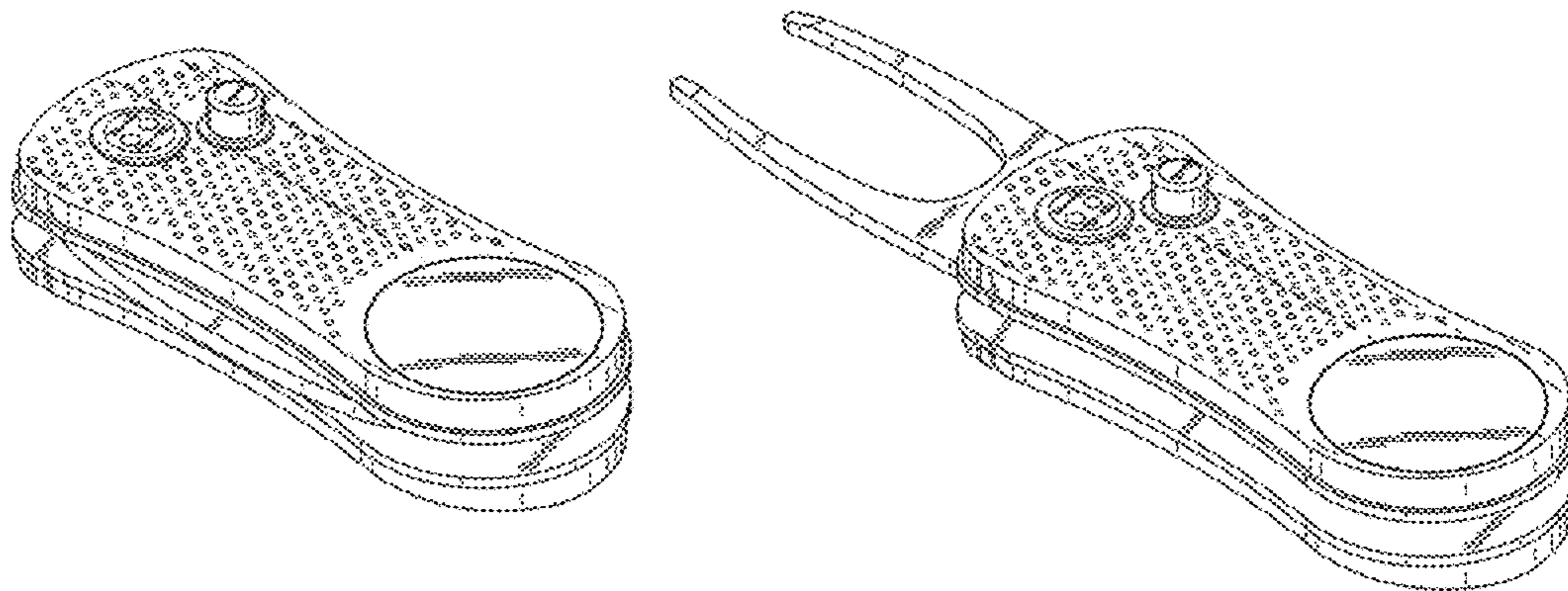

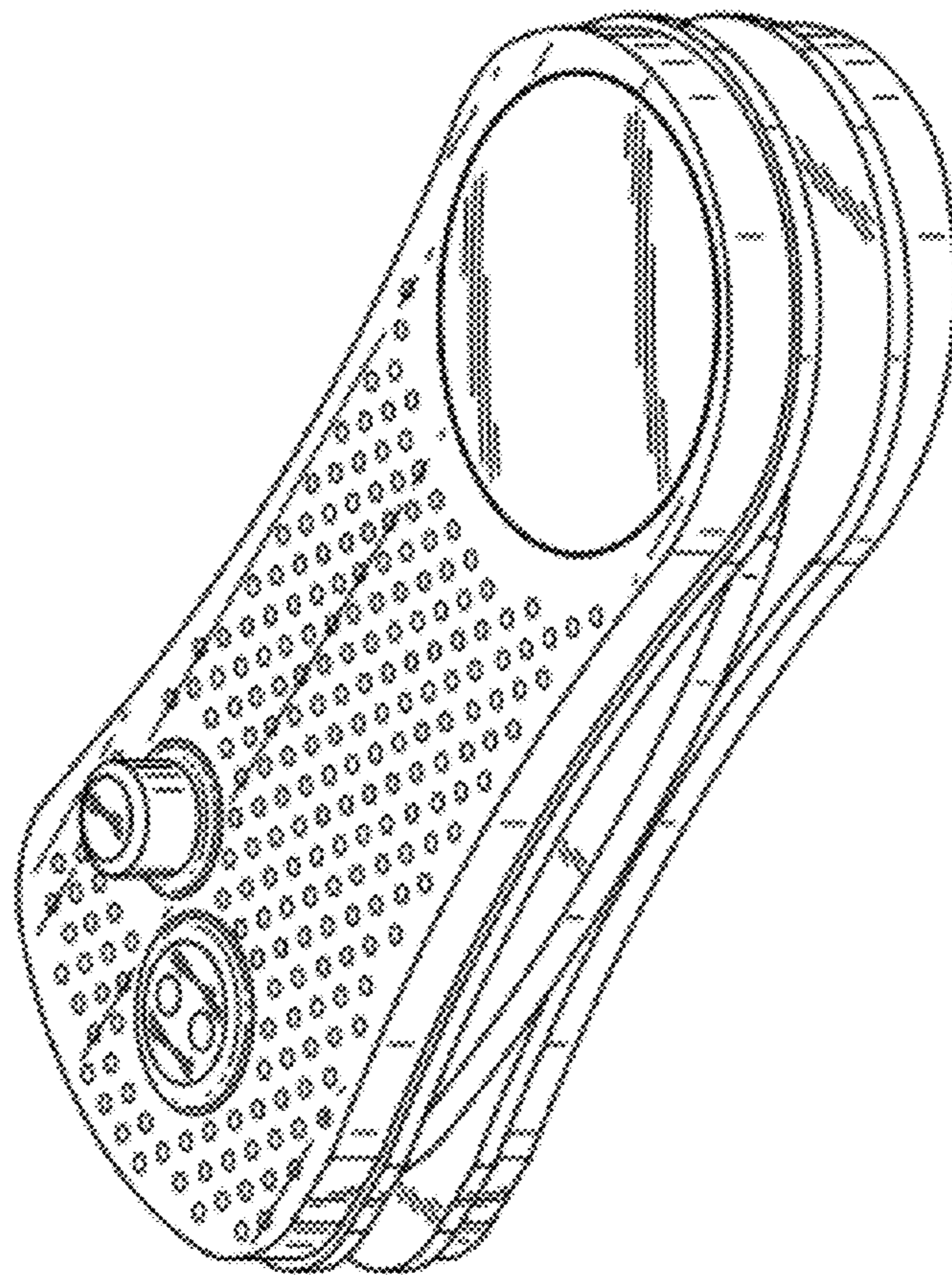

FIG. 1

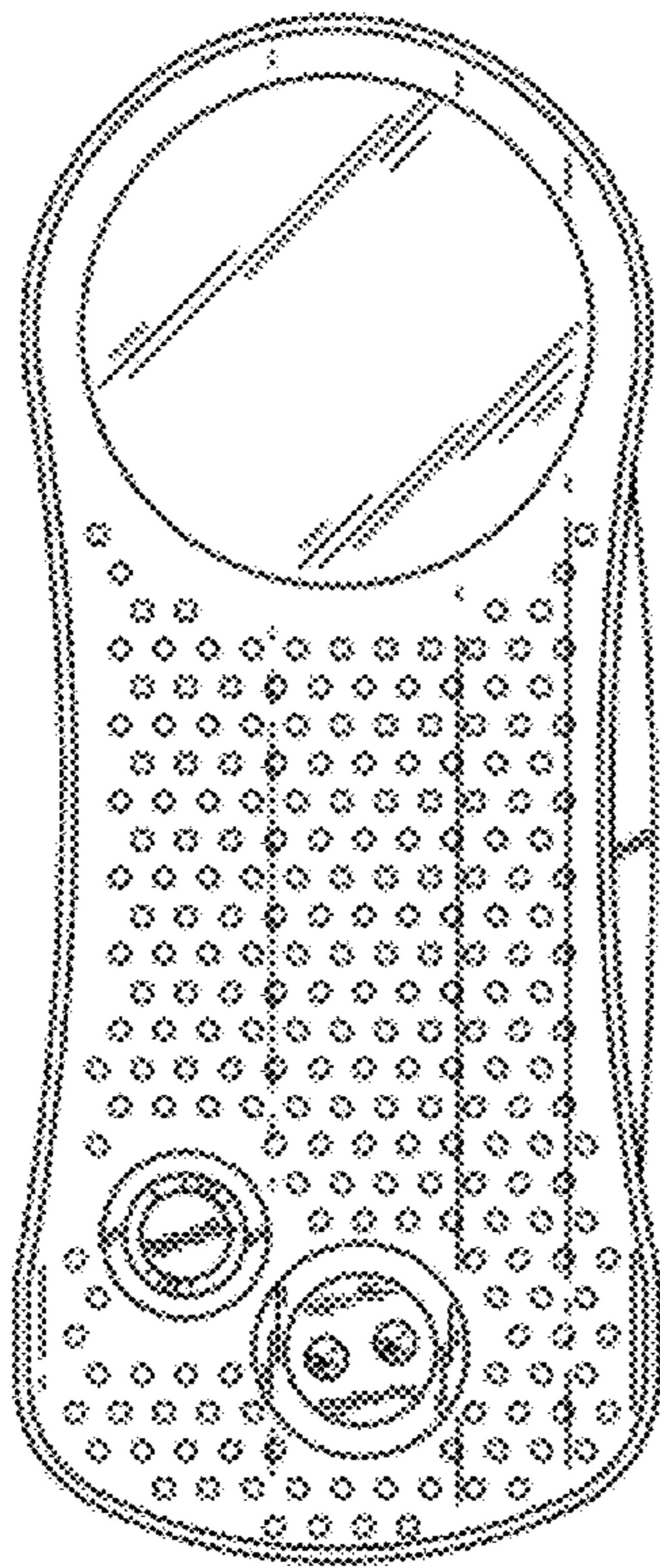

FIG. 2

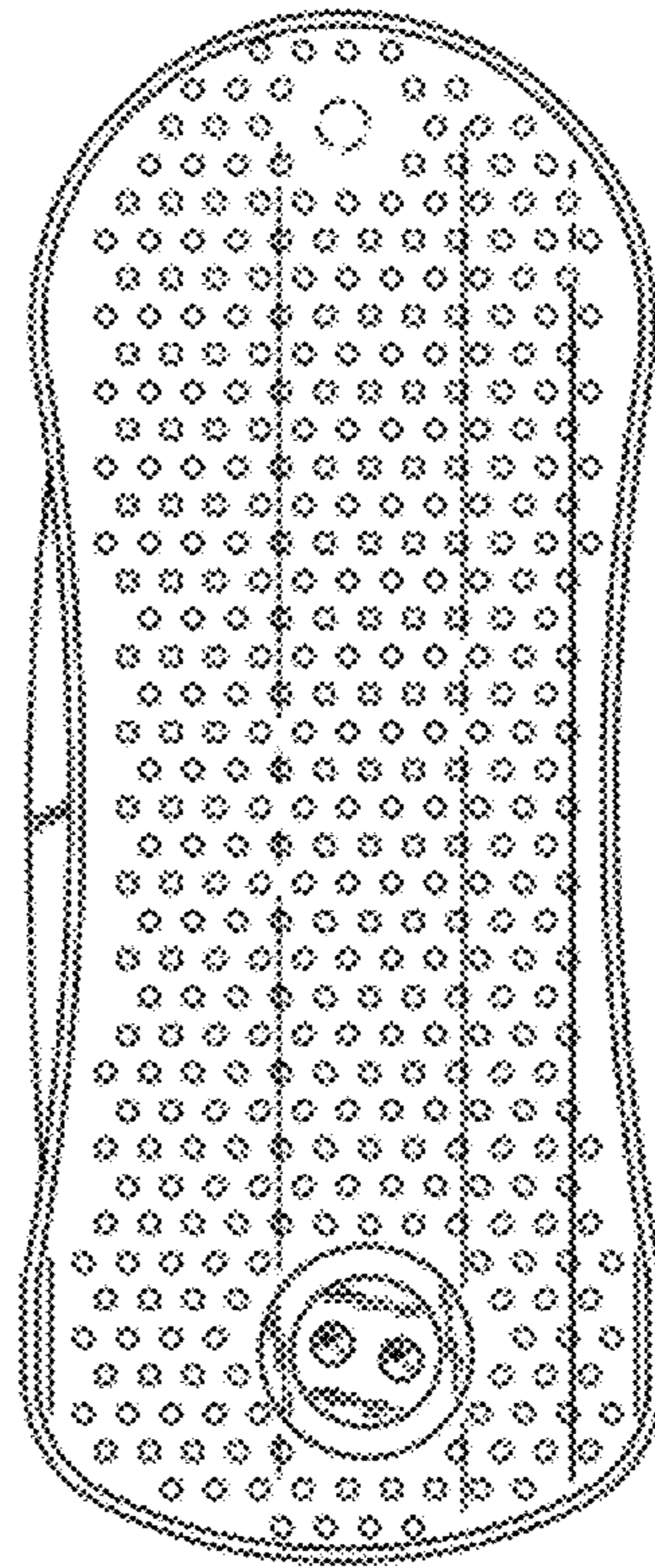

FIG. 3

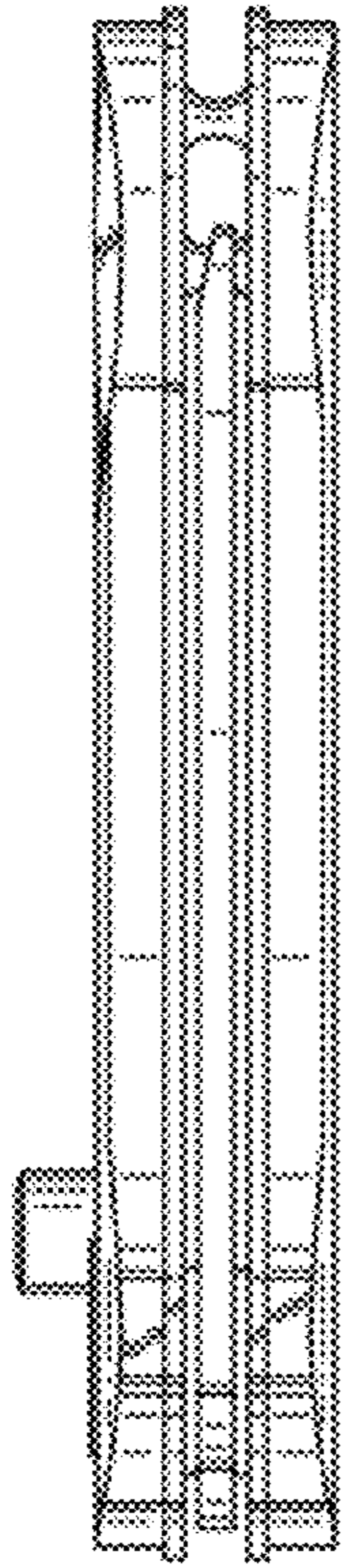

FIG. 4

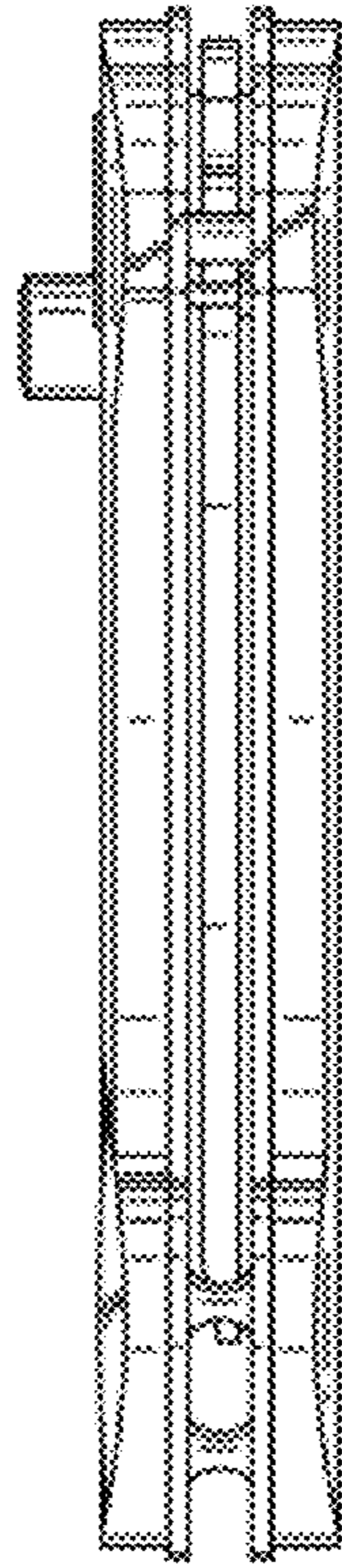

FIG. 5

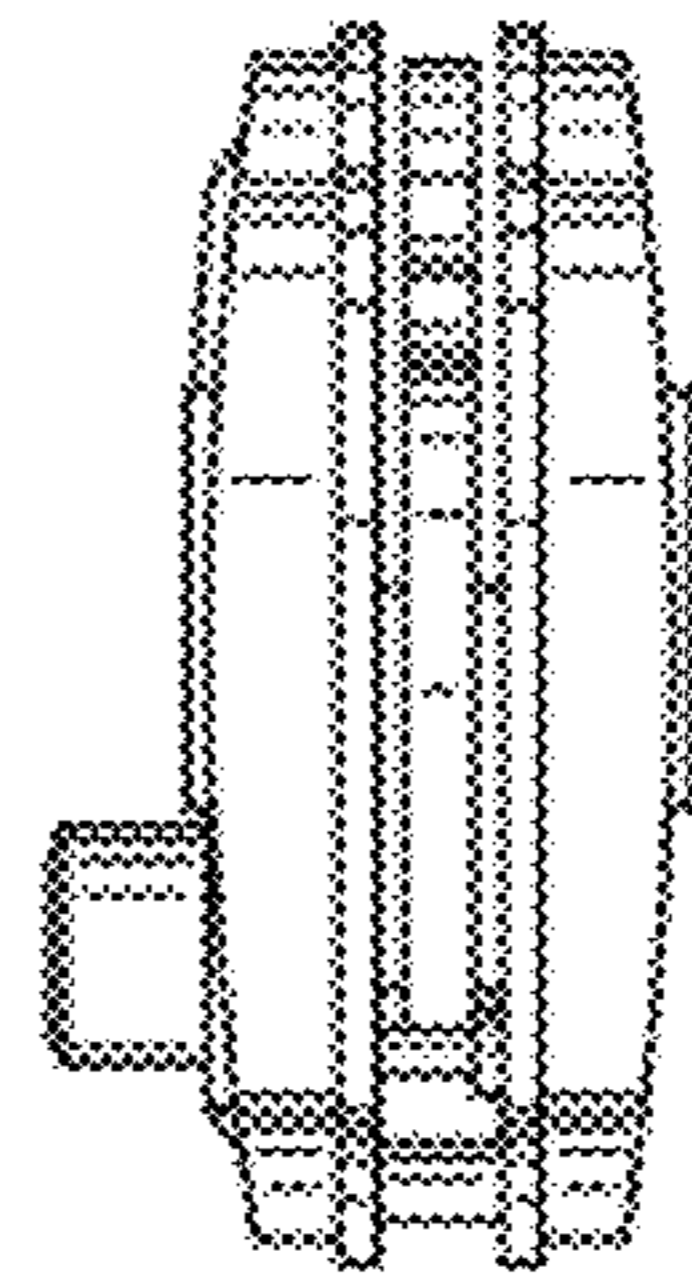

FIG. 6

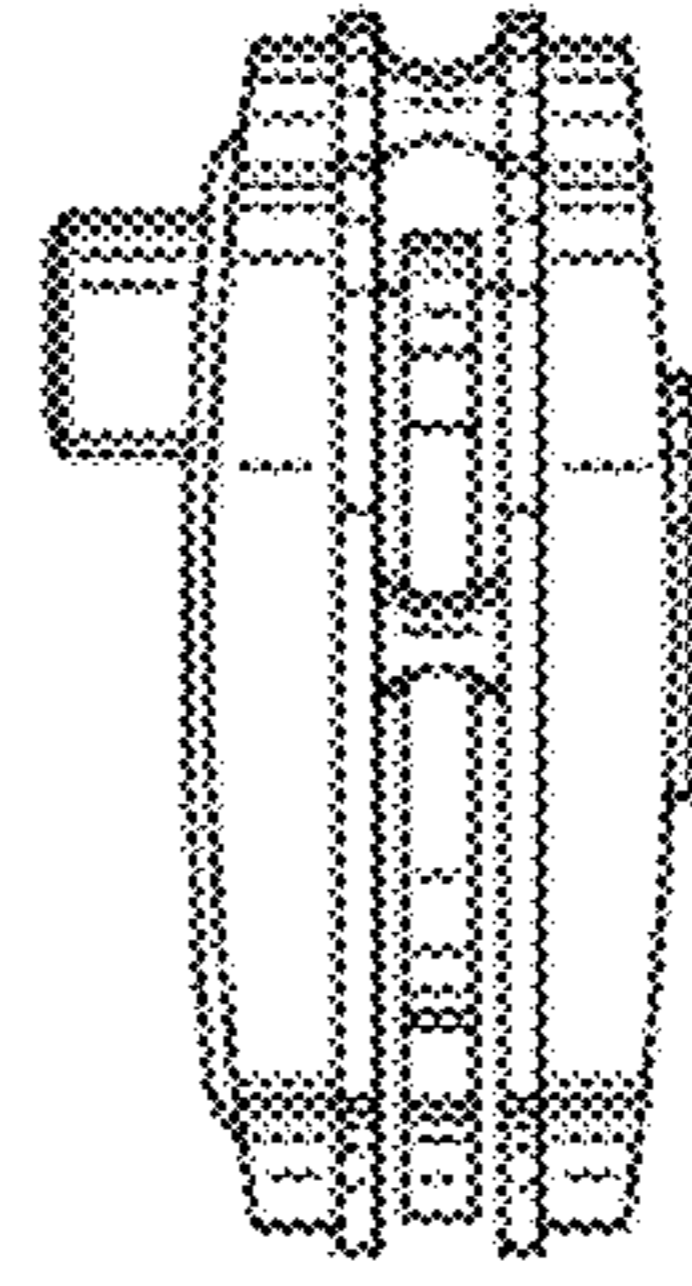

FIG. 7

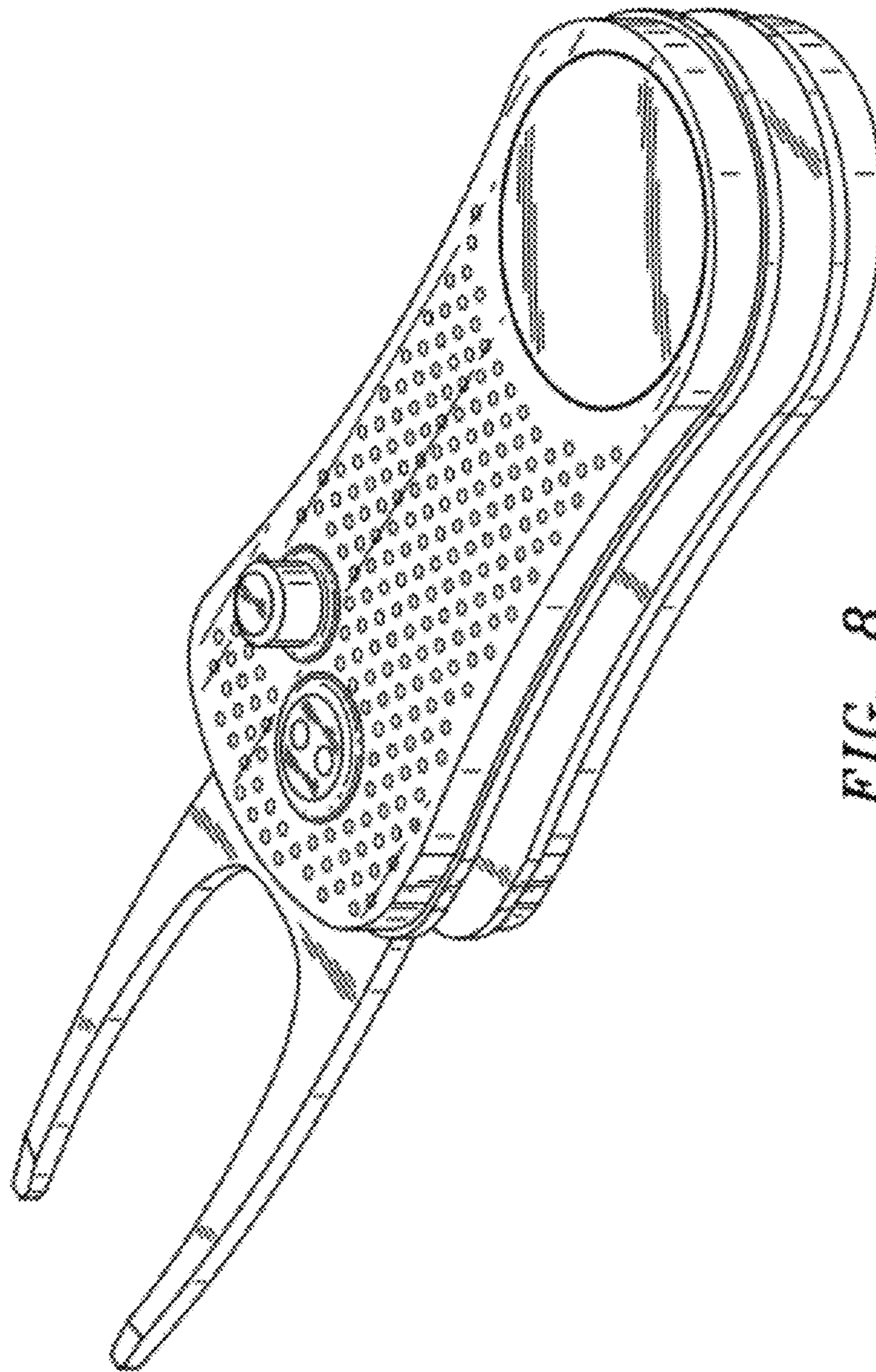

FIG. 8