



US00D66921S

(12) **United States Design Patent**
Kinser

(10) **Patent No.:** **US D669,921 S**

(45) **Date of Patent:** **** Oct. 30, 2012**

(54) **LOCKABLE FOOD STORAGE CONTAINER
INSERT FOR A REFRIGERATOR**

(76) Inventor: **Vance Kinser**, Knoxville, TN (US)

(**) Term: **14 Years**

(21) Appl. No.: **29/417,807**

(22) Filed: **Apr. 9, 2012**

Related U.S. Application Data

(63) Continuation of application No. 12/456,492, filed on Jun. 17, 2009.

(51) **LOC (9) Cl.** **15-07**

(52) **U.S. Cl.** **D15/89**

(58) **Field of Classification Search** D15/79-89,
D15/91; D6/445, 446; 312/400-409, 114,
312/116, 117, 119, 138.1, 139.2, 236; 62/441,
62/377, 326, 246-254, 457.1-457.9
See application file for complete search history.

(56) **References Cited**

U.S. PATENT DOCUMENTS

1,377,824	A *	5/1921	Forbes	62/326
D138,391	S *	8/1944	Baird	D15/86
2,942,438	A *	6/1960	Schmeling	62/377
D189,324	S *	11/1960	Garth	D15/86
D239,750	S *	5/1976	Sgombick	D6/446
4,384,191	A	5/1983	Guibert	
D284,196	S *	6/1986	Wolff	D15/89
4,606,112	A	8/1986	Jenkins et al.	
D333,567	S *	3/1993	Dziewa	D6/436
D341,144	S *	11/1993	Rice	D15/86
5,299,863	A *	4/1994	Albright, Jr.	312/404
D379,631	S *	6/1997	Odom	D15/86
6,085,542	A	7/2000	Johnson et al.	

6,782,710	B2 *	8/2004	Eveland et al.	62/441
D511,179	S	11/2005	Tunzi	
D515,813	S *	2/2006	Roberson	D3/319

* cited by examiner

Primary Examiner — Mitchell Siegel

(74) *Attorney, Agent, or Firm* — Montgomery Patent & Design, LLC; Robert C. Montgomery; Joseph Yaksich

(57) **CLAIM**

The ornamental design for a lockable food storage container insert for a refrigerator, as shown and described.

DESCRIPTION

FIG. 1 is a perspective front view of a lockable food storage container insert for a refrigerator, showing my new design; FIG. 2 is a front view thereof; FIG. 3 is a left view thereof; FIG. 4 is a left side view thereof with a right side view being a mirror image; FIG. 5 is a top view thereof; FIG. 6 is a bottom view thereof; FIG. 7 is a front perspective view of the lockable food storage container insert for a refrigerator depicted with two (2) of four (4) front doors in an open position; FIG. 8 is an environmental front perspective view of two (2) lockable food storage container inserts for a refrigerator depicted in a stacked orientation; and, FIG. 9 is an environmental front perspective view of four (4) lockable food storage container inserts for a refrigerator depicted in a stacked orientation within a refrigerator. The broken line showing of additional lockable food storage container inserts for a refrigerator shown in FIGS. 8 and 9 and of a refrigerator in FIG. 9 are for the purpose of illustrating environment and forms no part of the claimed design.

1 Claim, 9 Drawing Sheets

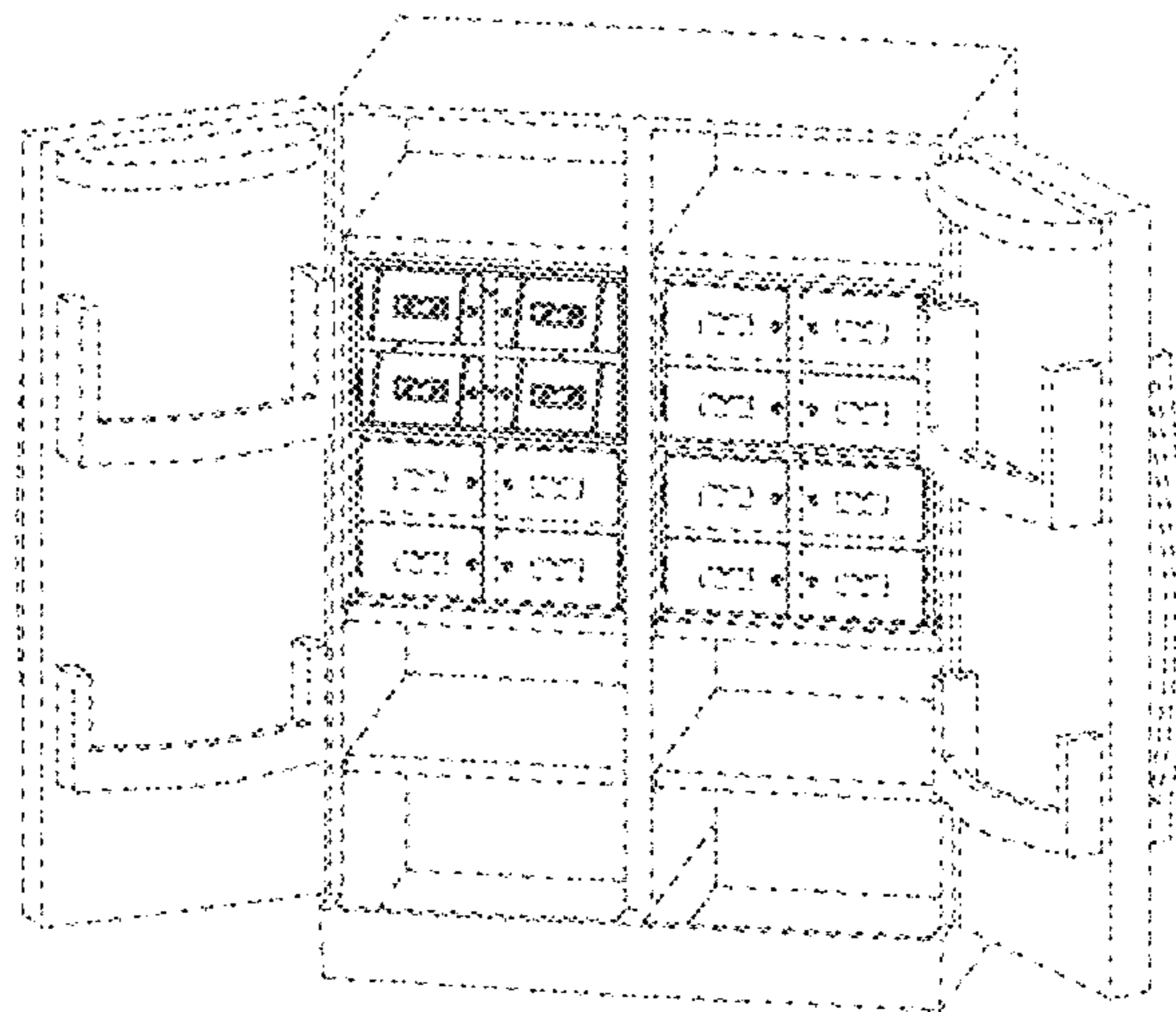
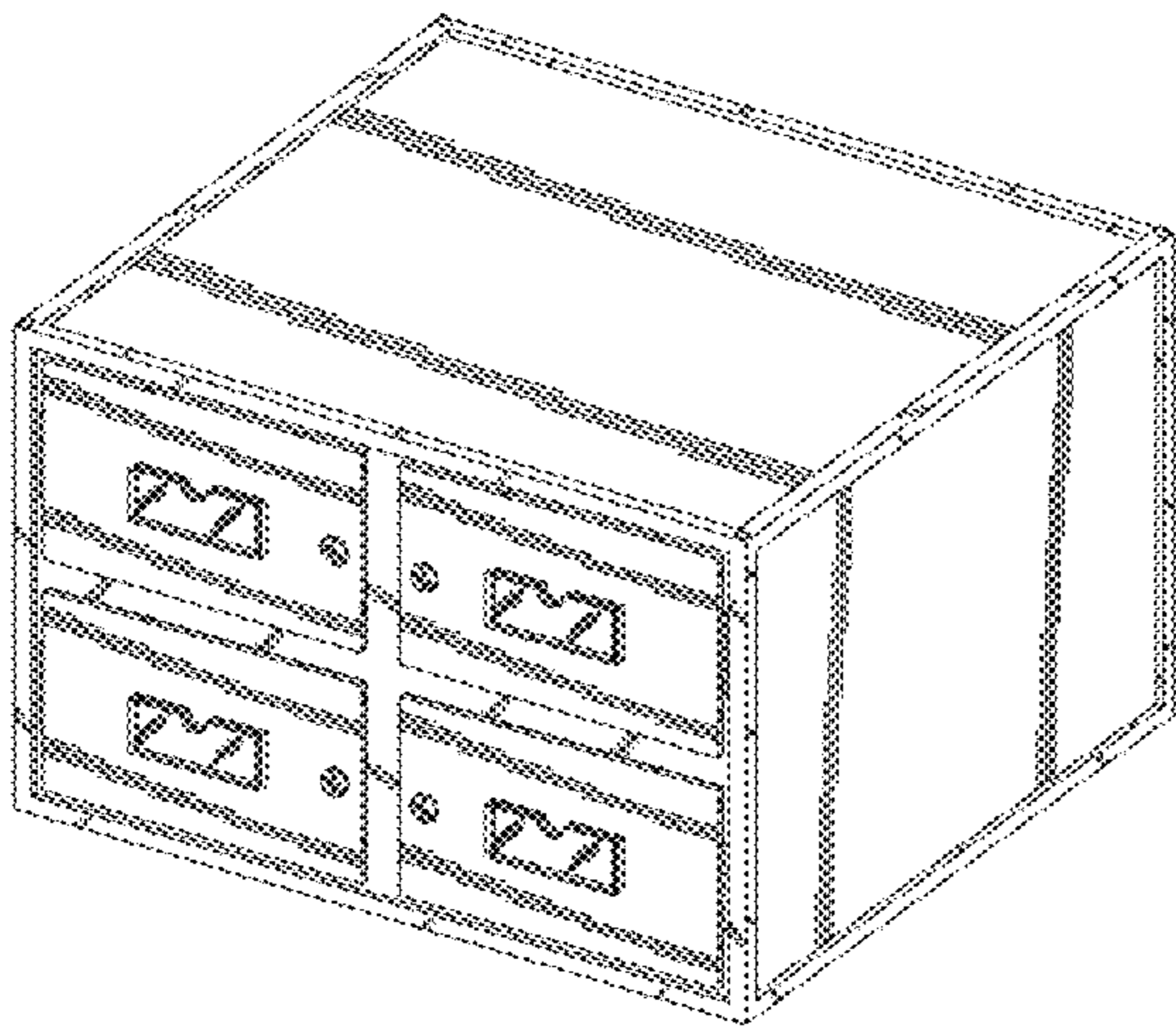

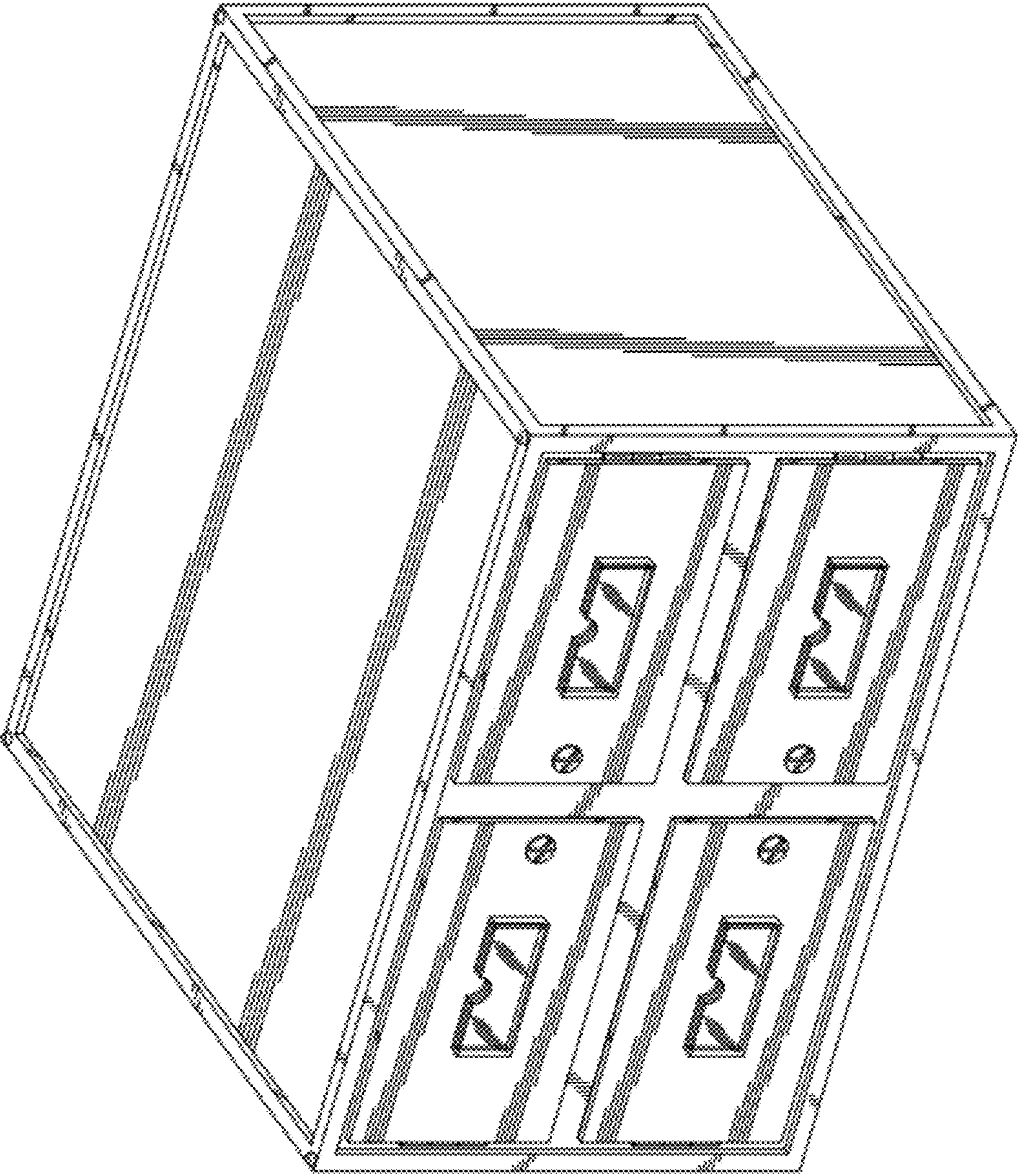

Fig. 1

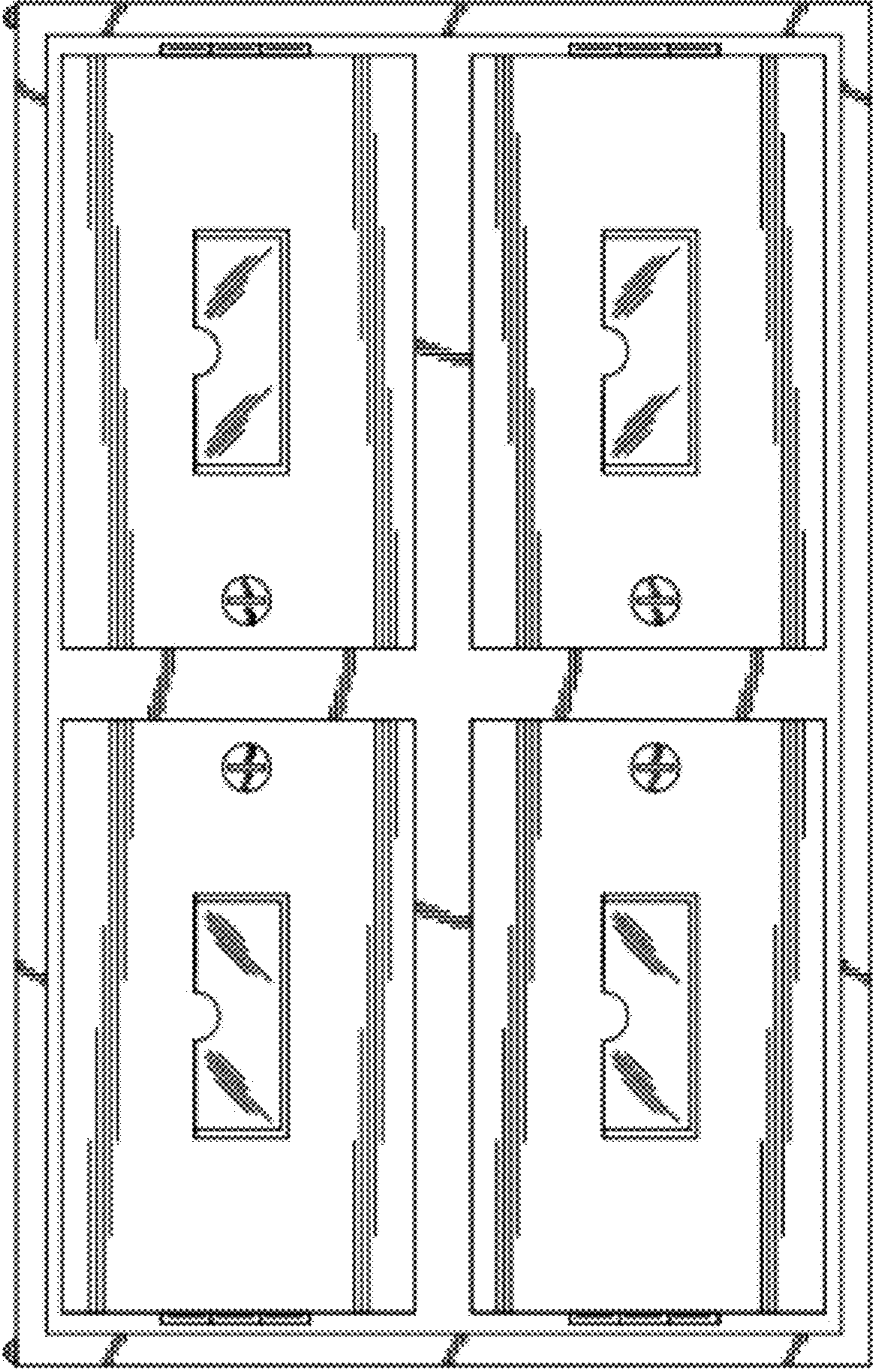

Fig. 2

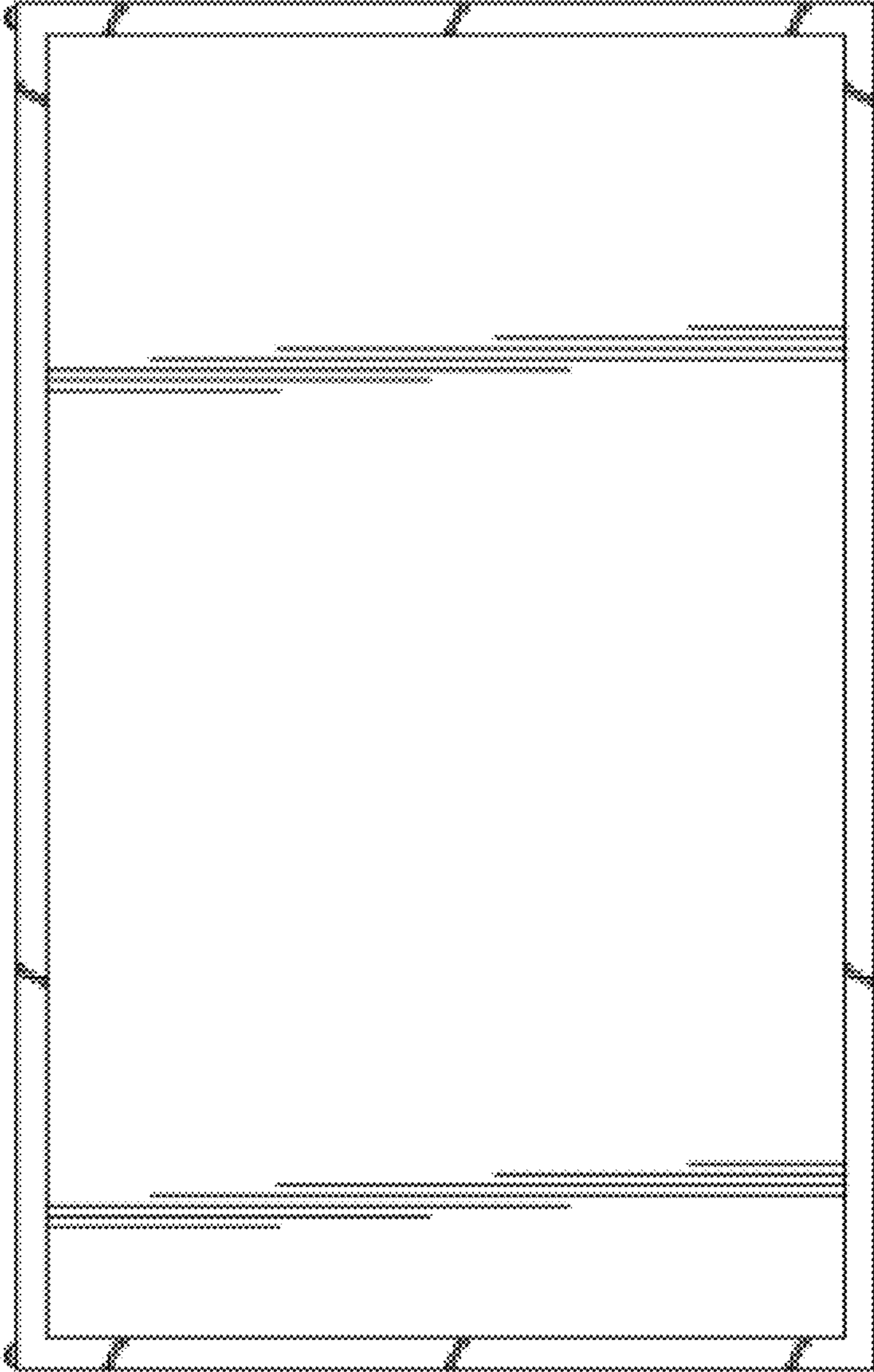

Fig. 3

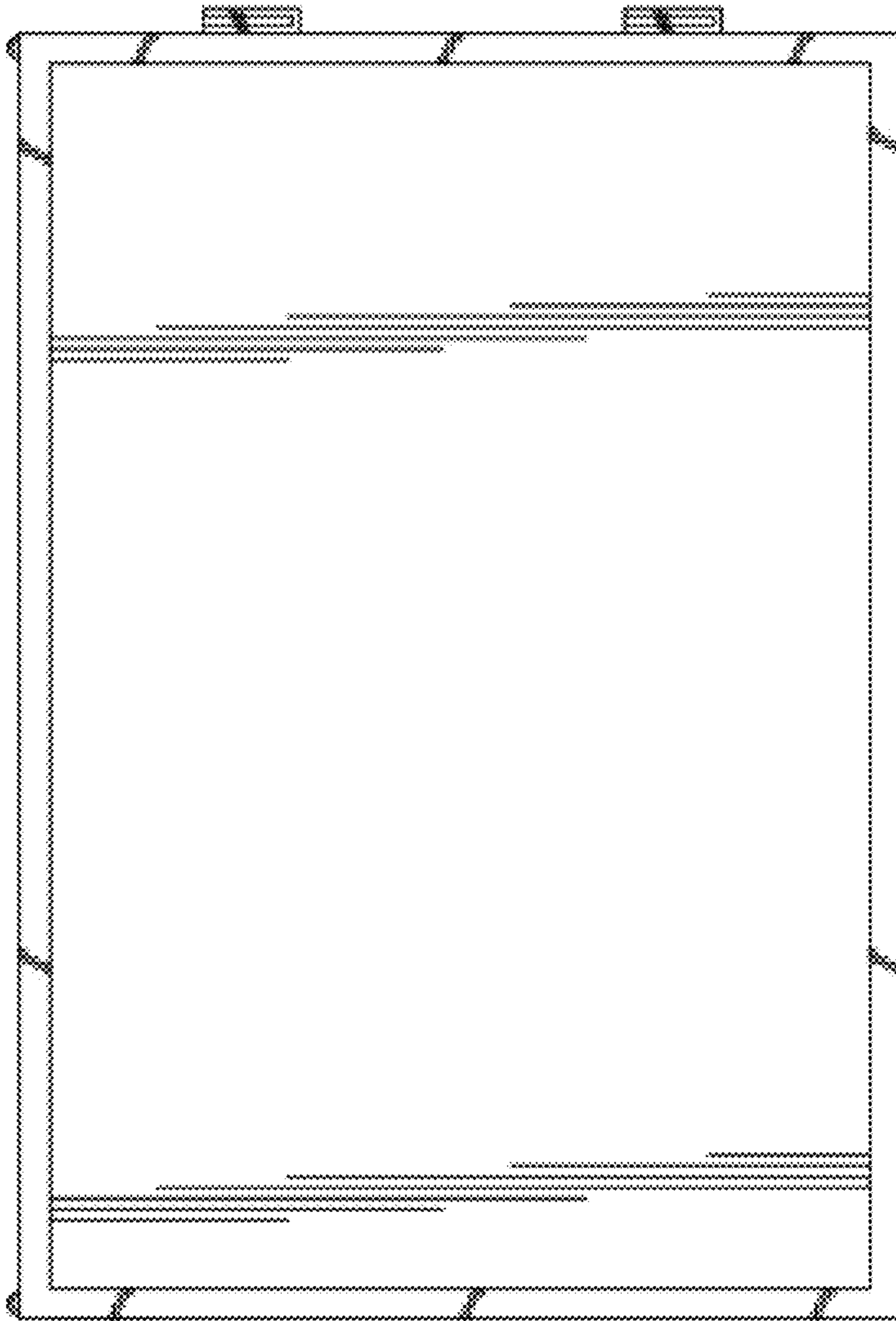

Fig. 4

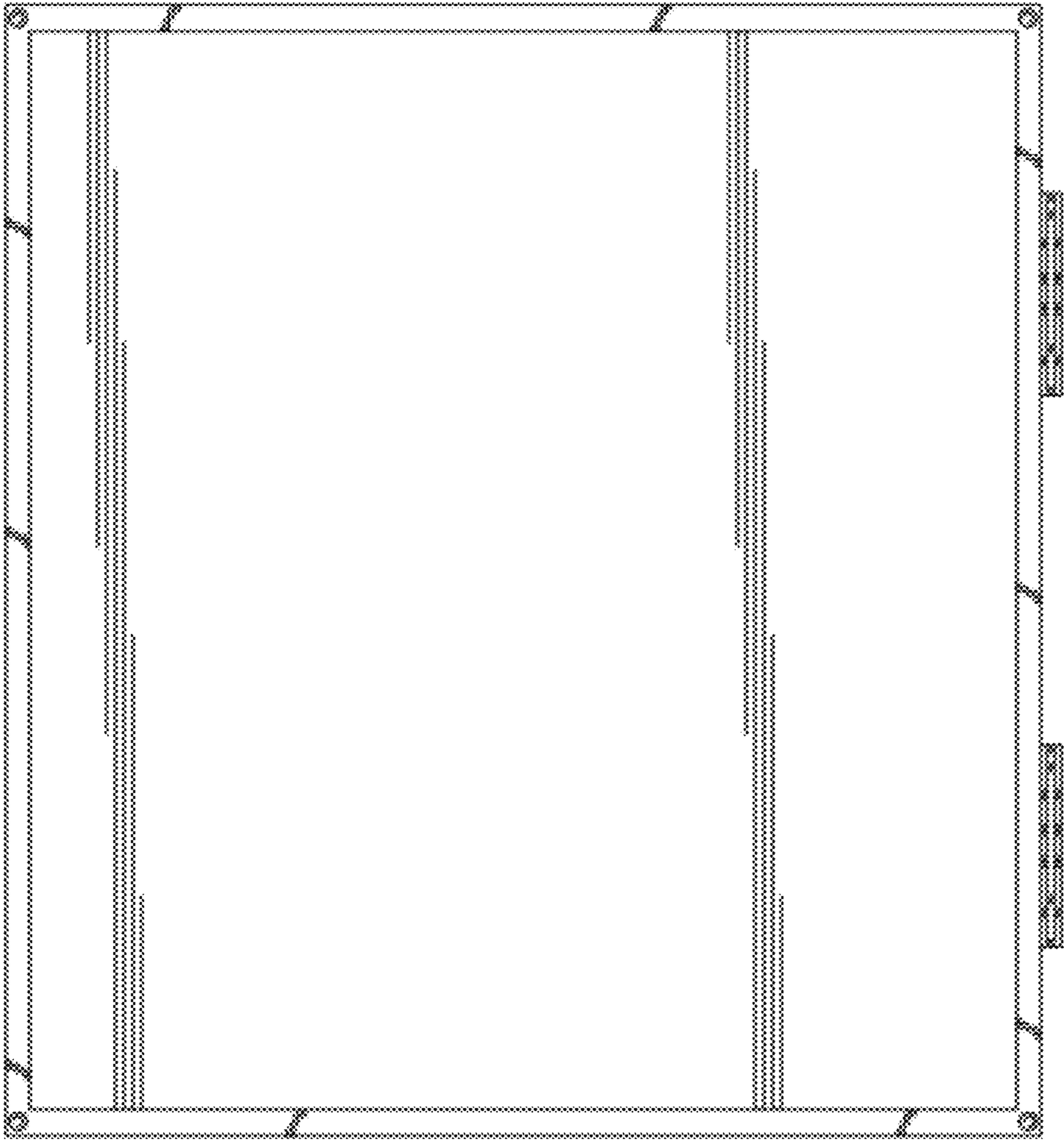

Fig. 5

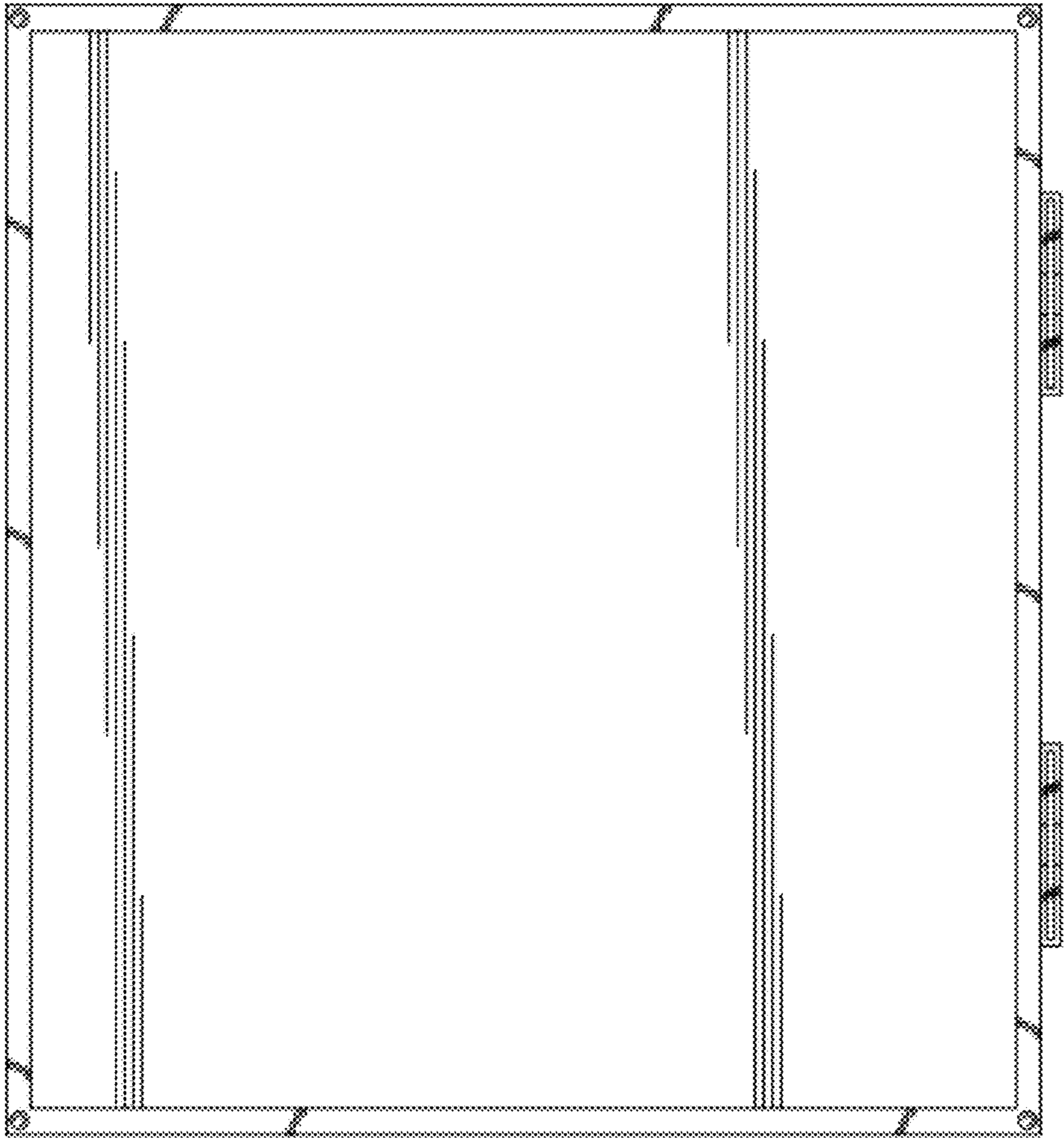

Fig. 6

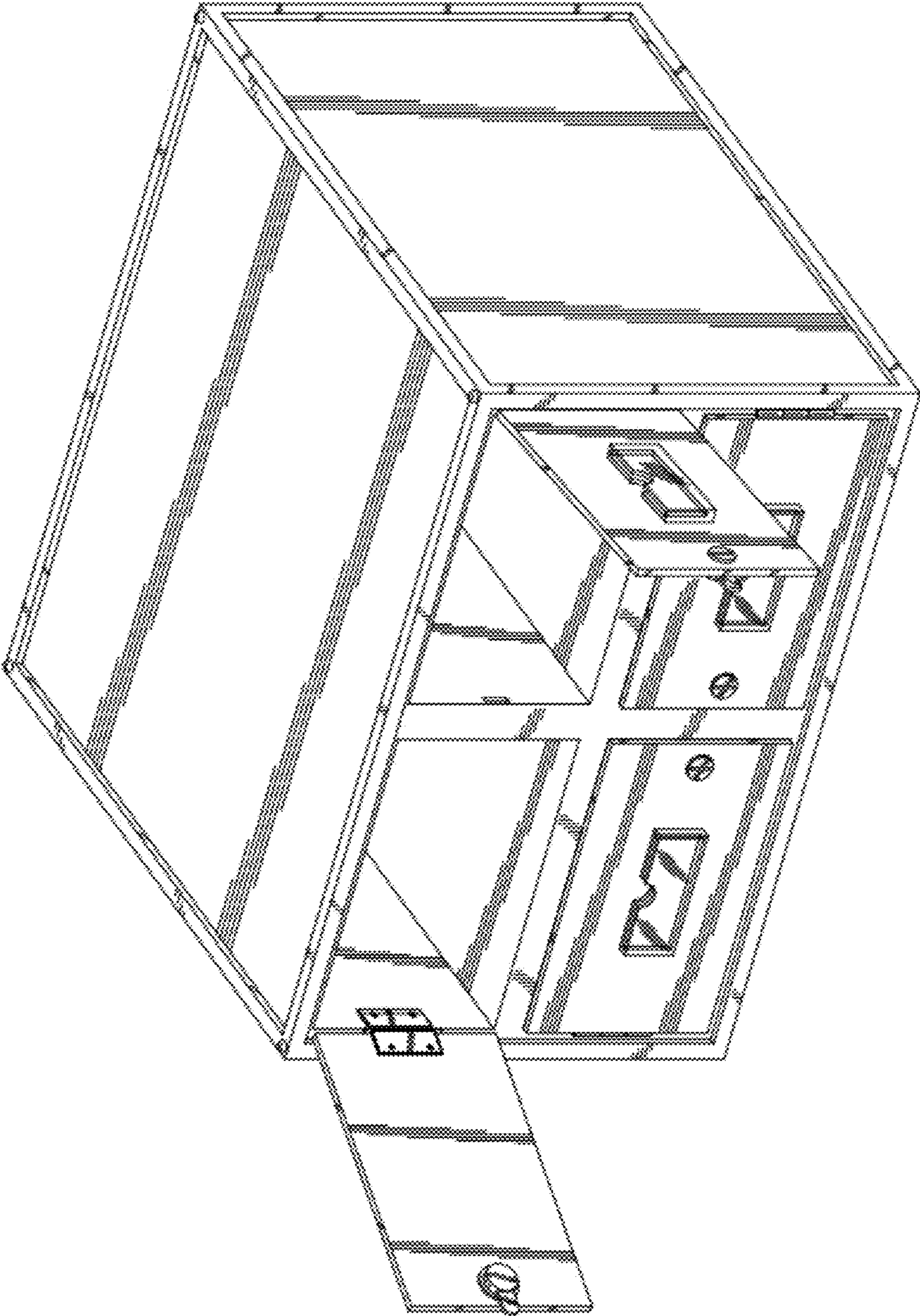

Fig. 7

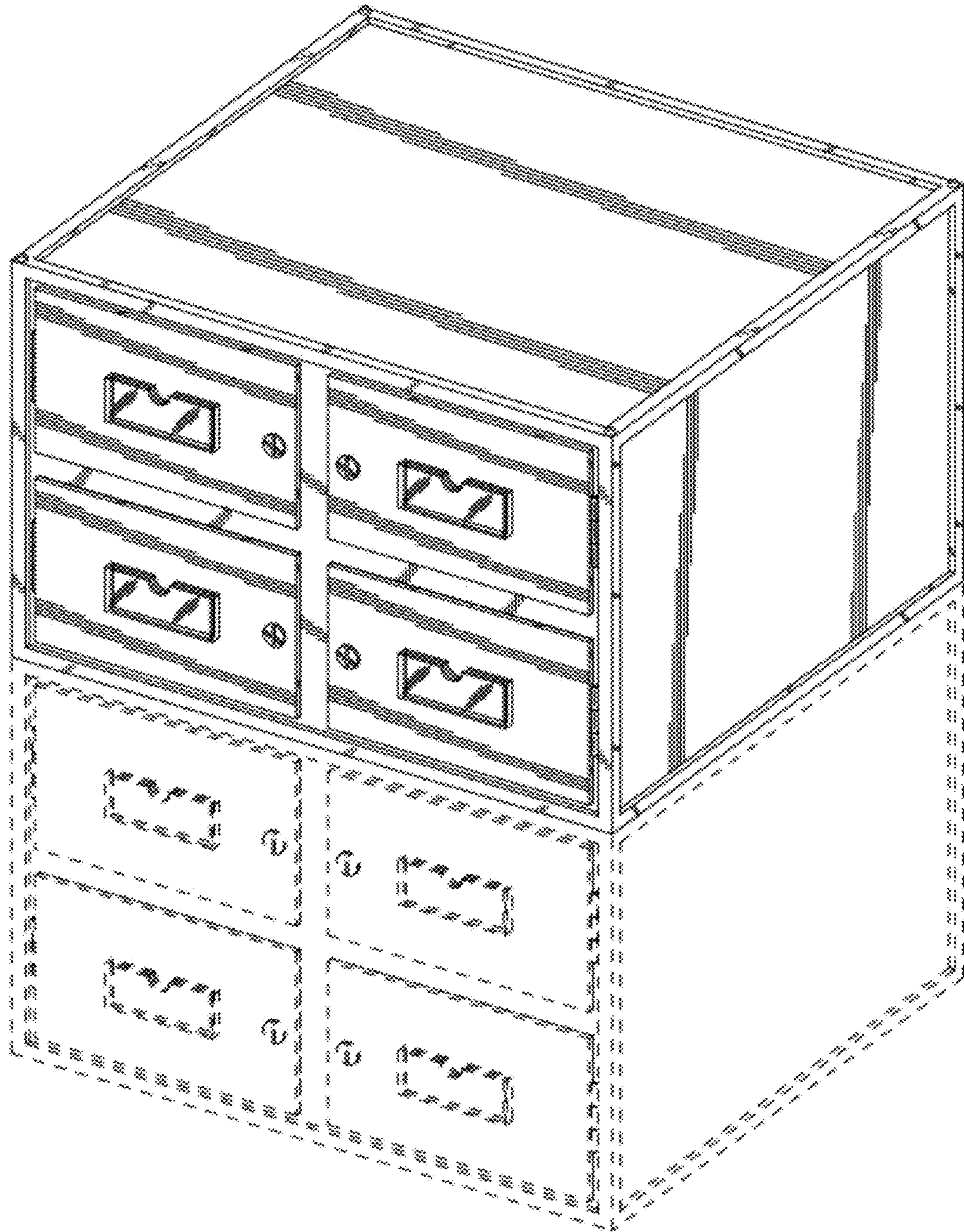

Fig. 8

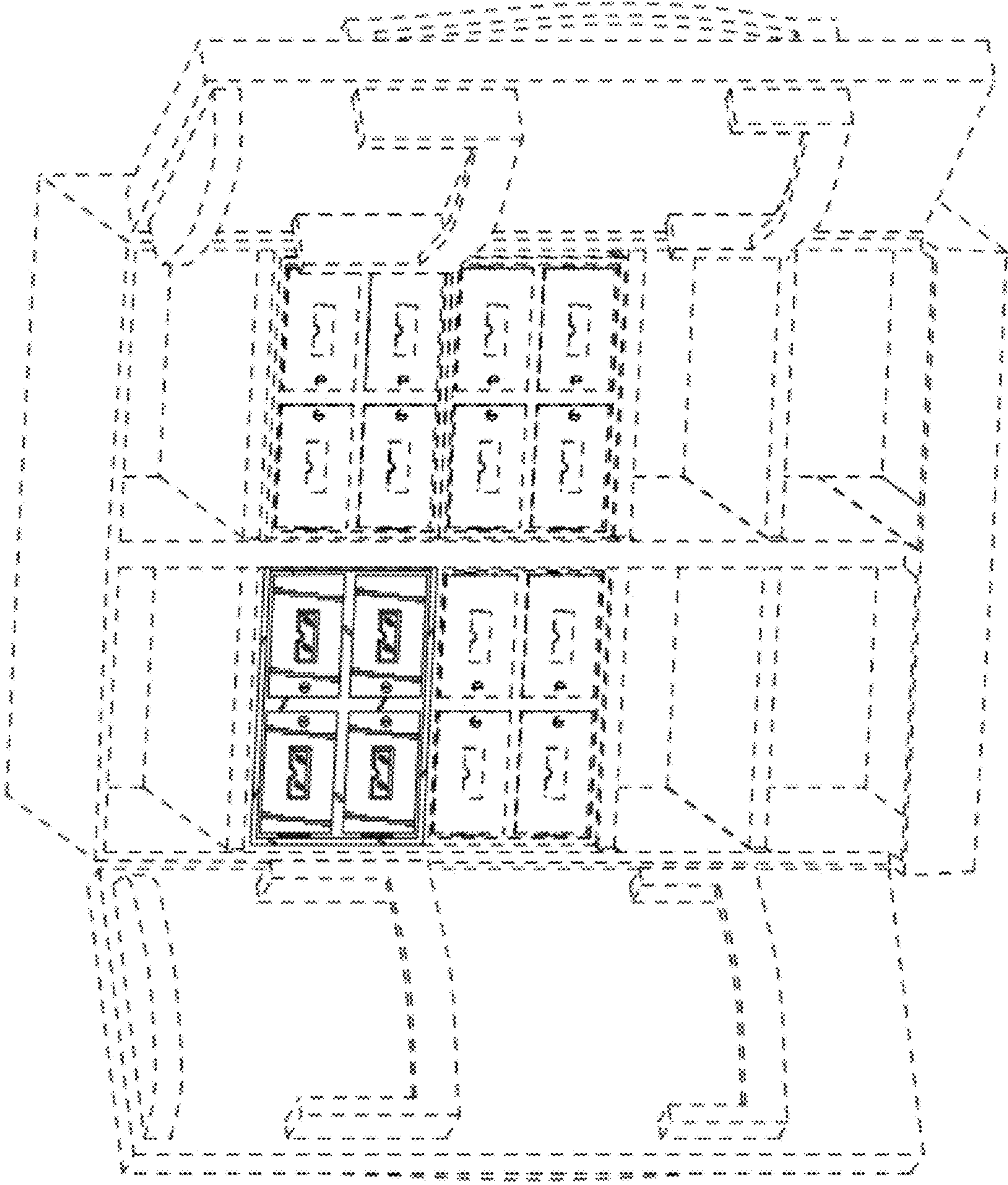

Fig. 9