



US00D669919S

(12) **United States Design Patent**
Attwood et al.

(10) **Patent No.:** **US D669,919 S**

(45) **Date of Patent:** **** Oct. 30, 2012**

(54) **EXCAVATION BUCKET**

(75) Inventors: **Reece Attwood**, Mayfield West (AU);
Glenn Baxter, Duncraig (AU); **Jason Lunn**, Lambton (AU)

(73) Assignee: **Bradken Resources Pty Limited**,
Mayfield West (AU)

(**) Term: **14 Years**

(21) Appl. No.: **29/416,728**

(22) Filed: **Mar. 26, 2012**

(30) **Foreign Application Priority Data**

Sep. 27, 2011 (AU) 14342/2011

(51) **LOC (9) Cl.** **15-03**

(52) **U.S. Cl.** **D15/32**

(58) **Field of Classification Search** D15/10,
D15/22-26, 28, 29, 32; D21/537; 414/722,
414/723, 686; 172/272-275; 403/324, 326,
403/315, 322.1; 37/403, 405, 408, 409, 411,
37/468, 444, 446, 443, 435, 379
See application file for complete search history.

(56) **References Cited**

U.S. PATENT DOCUMENTS

D274,622 S * 7/1984 Neander D15/32
D299,723 S * 2/1989 Frawley D15/32
D308,528 S * 6/1990 Harr D15/32
5,416,990 A * 5/1995 Otwell 37/445

5,456,028 A * 10/1995 Larson 37/404
5,472,249 A * 12/1995 Fiedler 294/2
5,544,435 A * 8/1996 Somero 37/405
5,553,408 A * 9/1996 Townsend 37/406
5,813,822 A * 9/1998 Pisco 414/723
6,070,345 A * 6/2000 Akaki et al. 37/407
D469,786 S * 2/2003 Miller et al. D15/24
6,659,708 B2 * 12/2003 Heiple 414/723
D491,198 S * 6/2004 Rowlands D15/28
D501,662 S * 2/2005 Rowlands D15/28
D551,684 S * 9/2007 McClallen et al. D15/32
D616,469 S * 5/2010 Ballinger et al. D15/32
2010/0037493 A1 * 2/2010 Kim et al. 37/444
2011/0094130 A1 * 4/2011 Hilton 37/444
2011/0099860 A1 * 5/2011 Sirr 37/403
2011/0126434 A1 * 6/2011 Horton 37/444

* cited by examiner

Primary Examiner — Mark Goodwin

(74) *Attorney, Agent, or Firm* — Morrison & Foerster LLP

(57) **CLAIM**

We claim the design for an excavation bucket, as shown and described.

DESCRIPTION

FIG. 1 is an isometric view of an excavation bucket showing our new design;

FIG. 2 is a front view thereof;

FIG. 3 is a back view thereof;

FIG. 4 is a top view thereof;

FIG. 5 is a bottom view thereof;

FIG. 6 is a right side view thereof; and,

FIG. 7 is a left side view thereof.

1 Claim, 4 Drawing Sheets

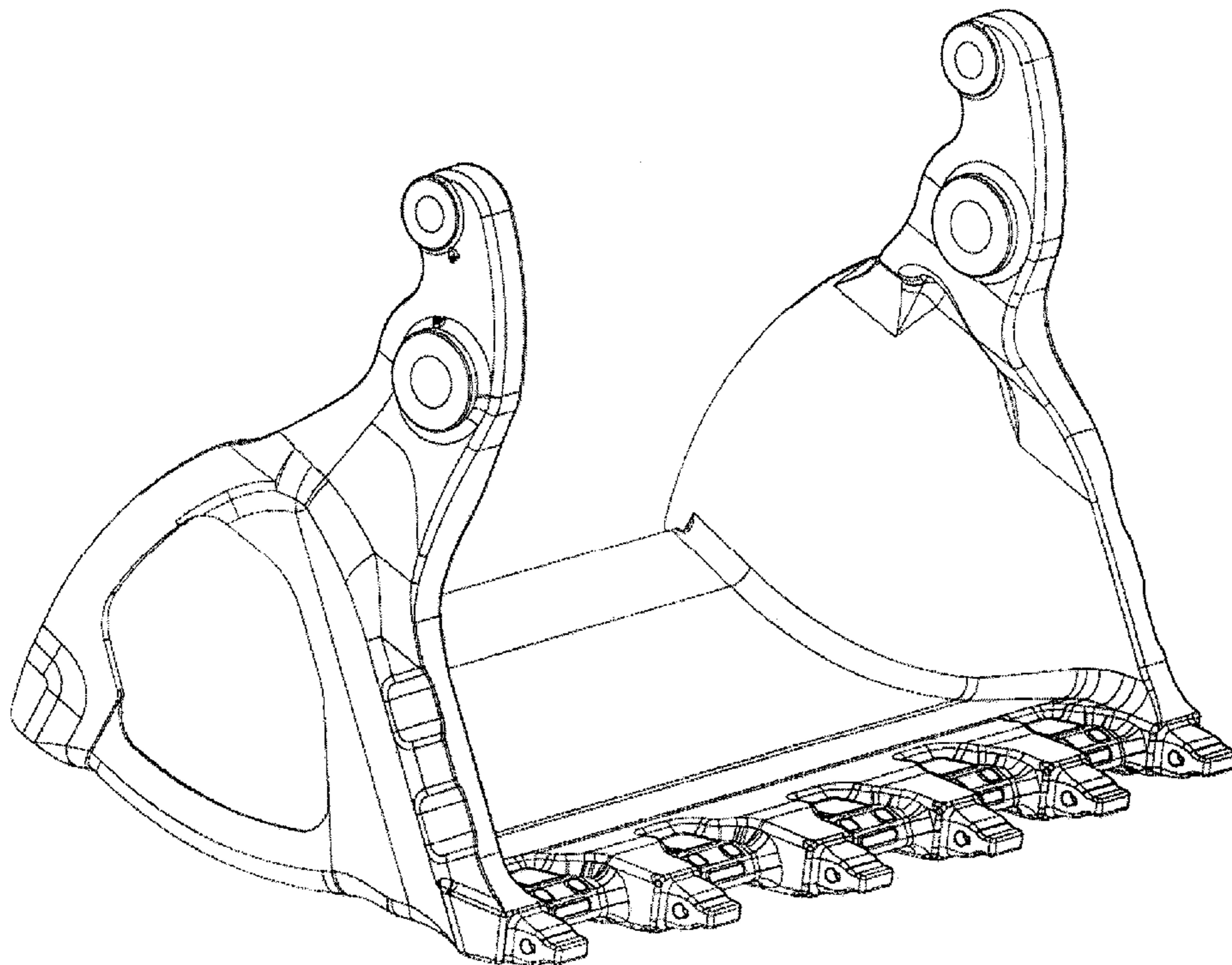

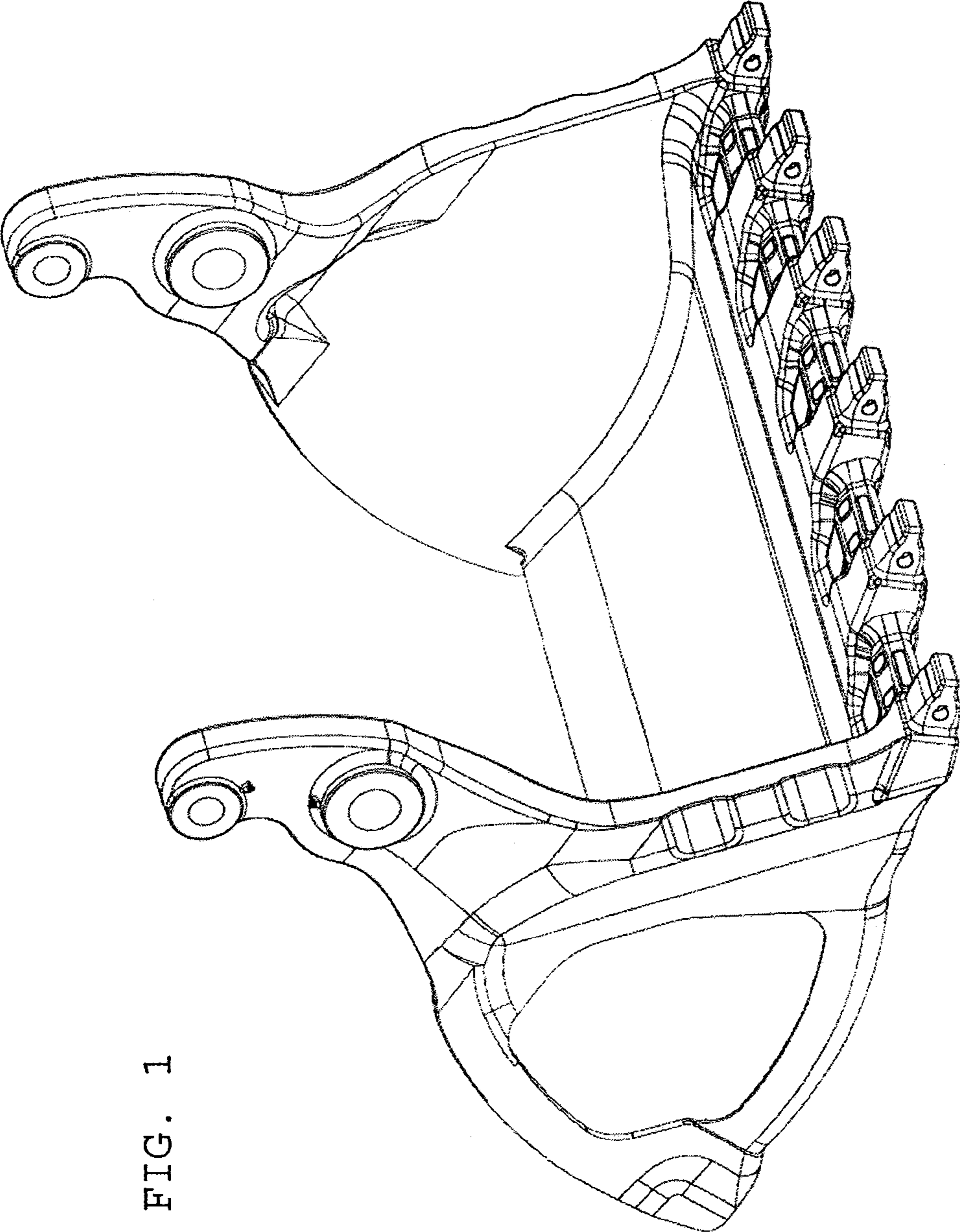

FIG. 1

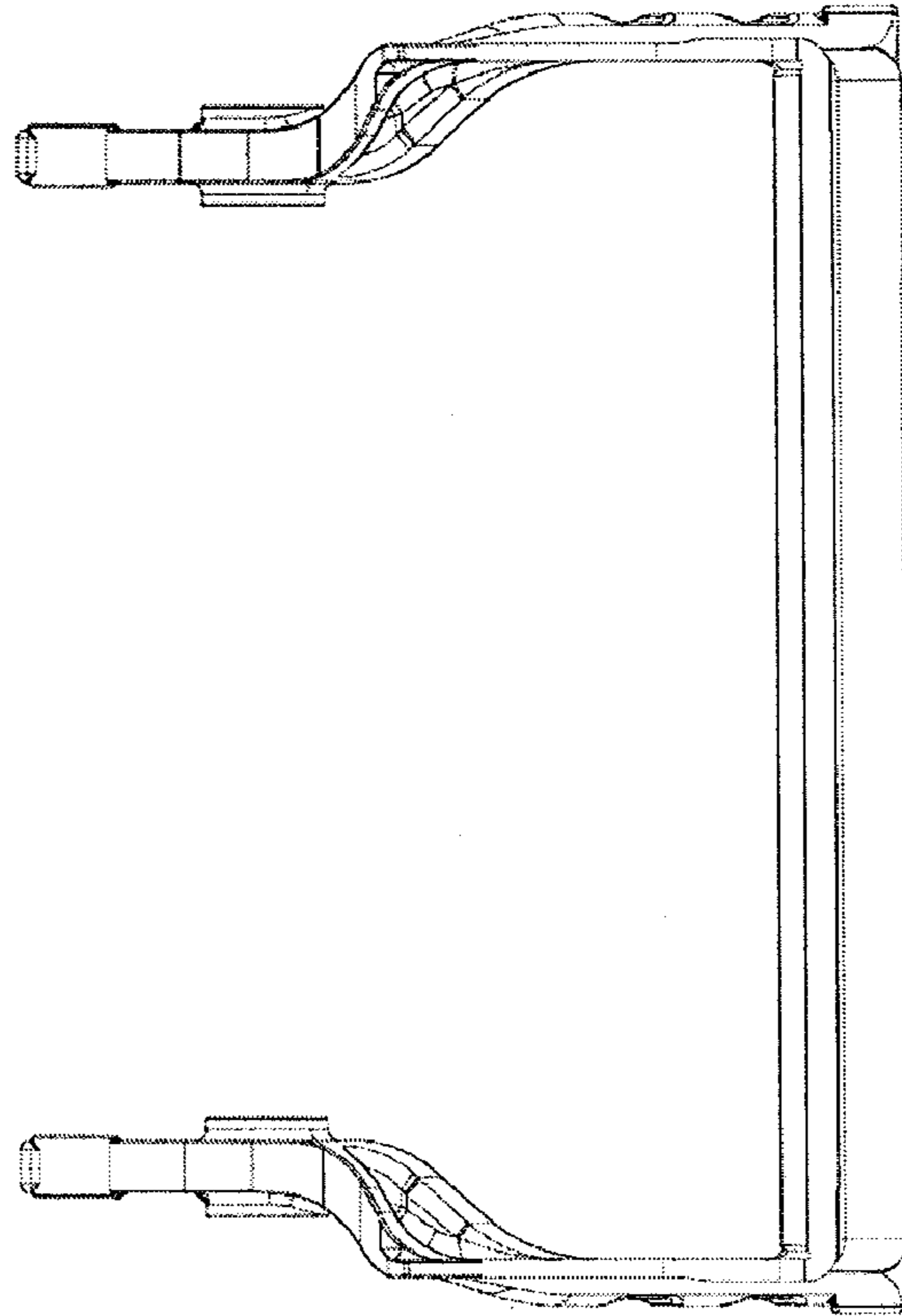

FIG. 2

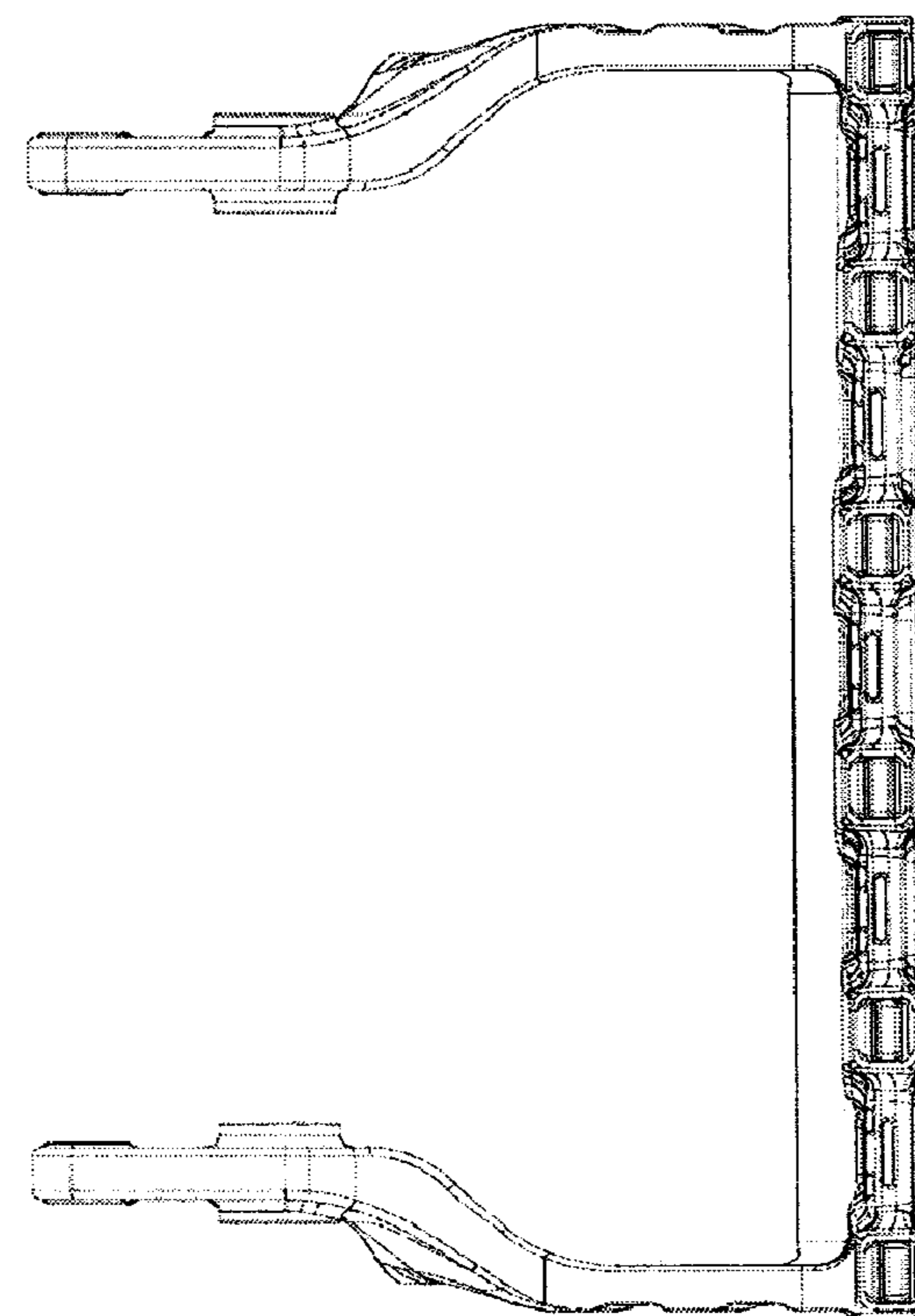

FIG. 3

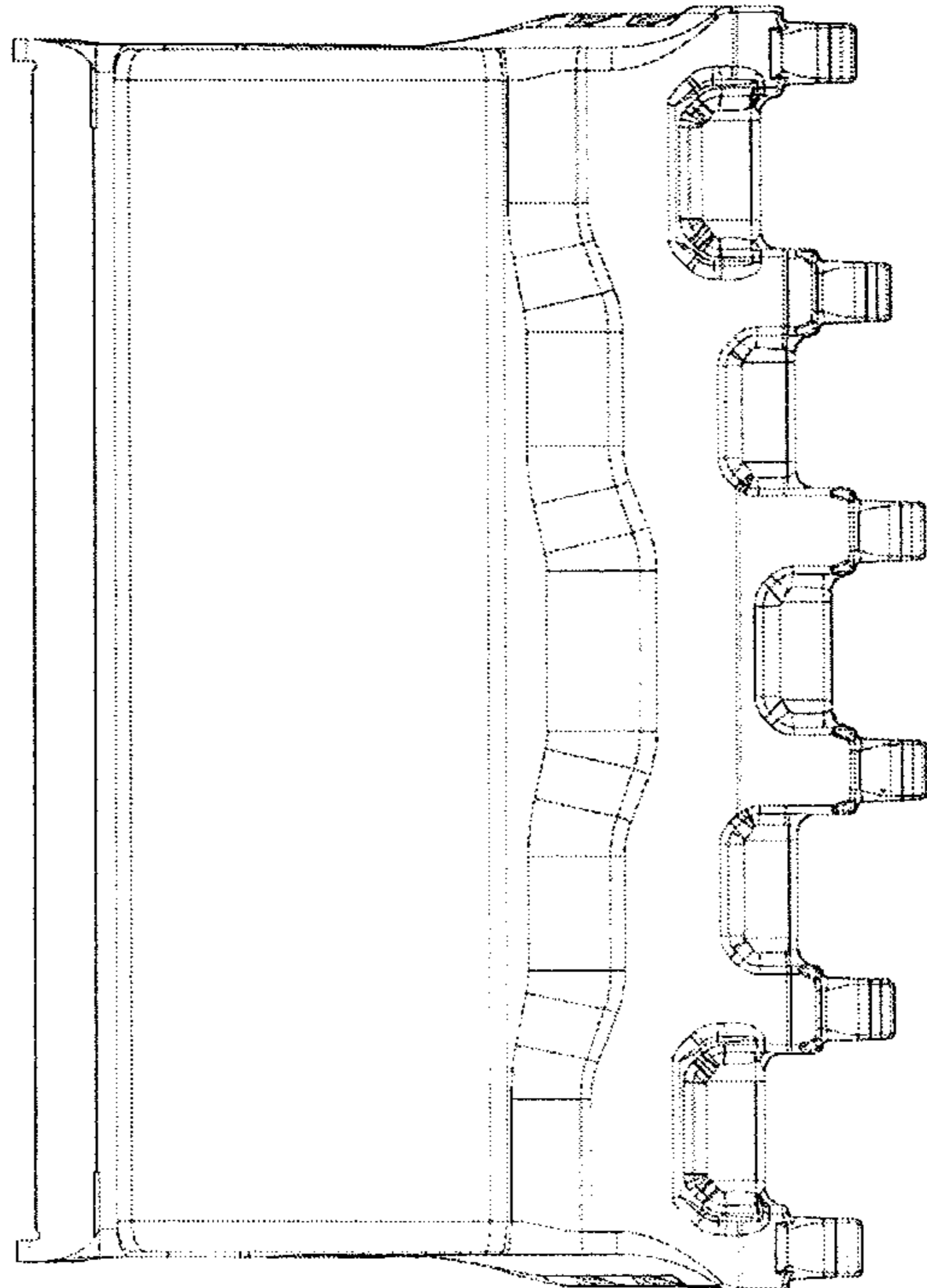

FIG. 4

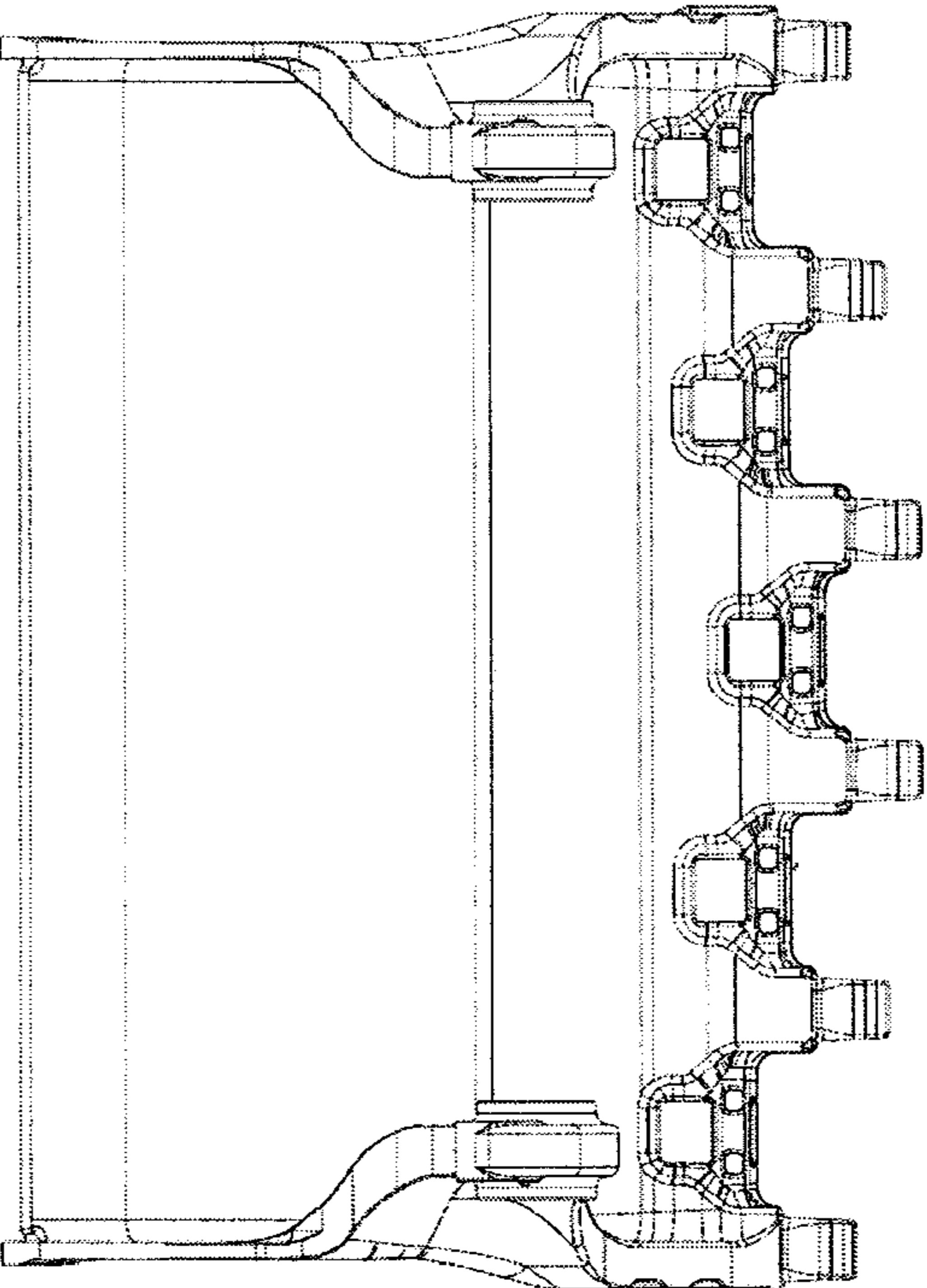

FIG. 5

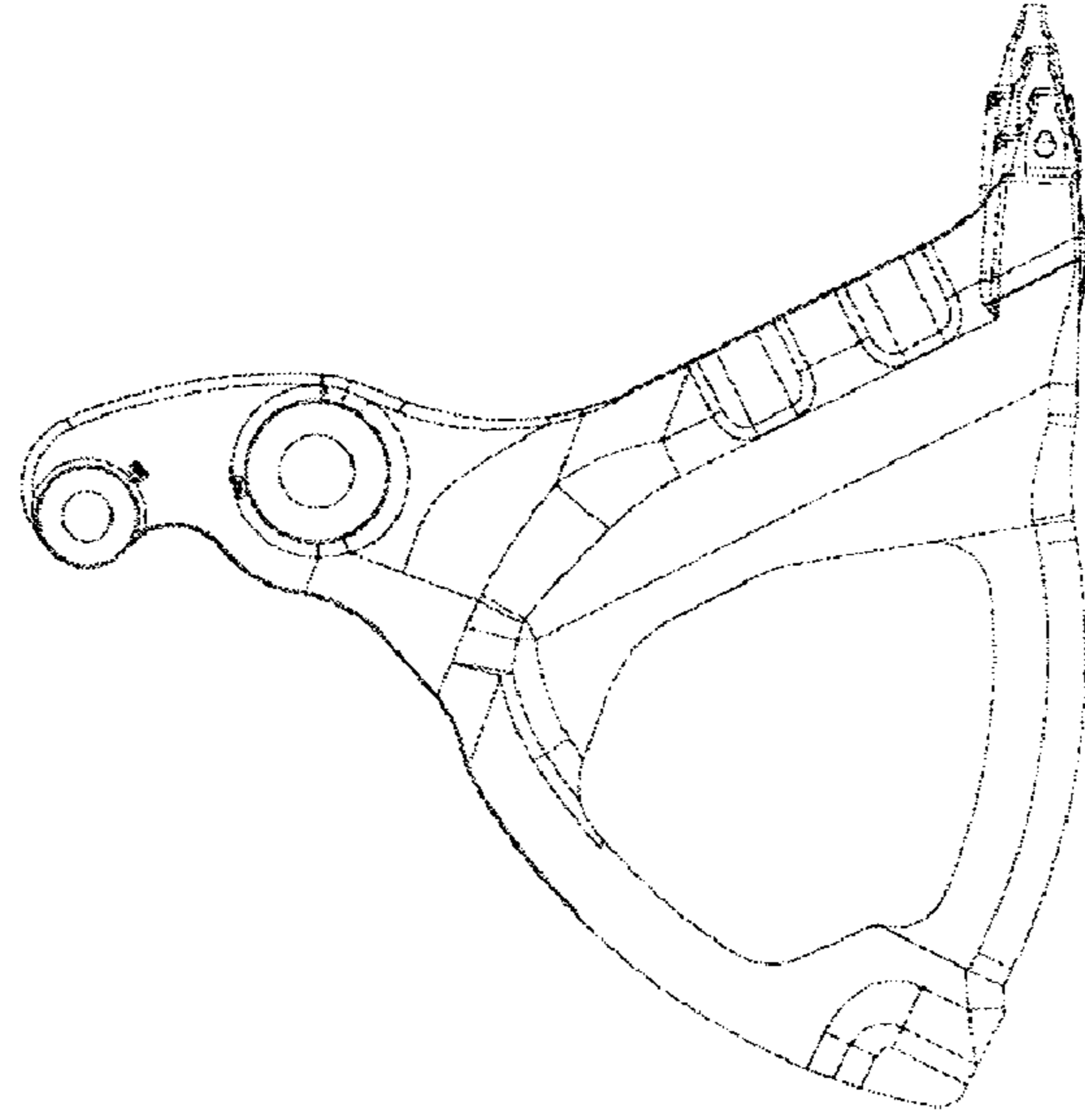

FIG. 6

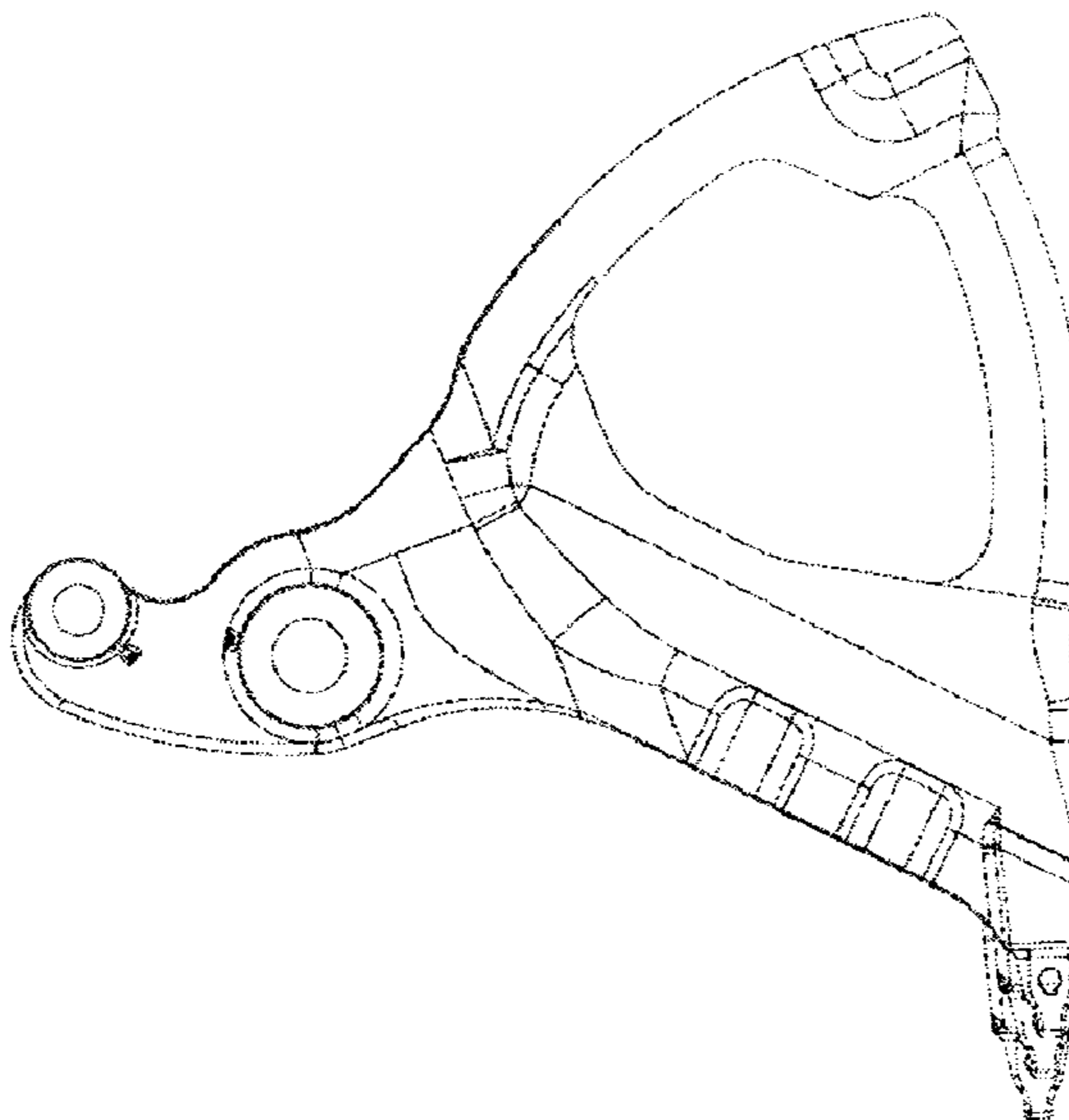

FIG. 7