



US00D669896S

(12) **United States Design Patent**
Nakata

(10) **Patent No.:** **US D669,896 S**

(45) **Date of Patent:** **** Oct. 30, 2012**

(54) **STYLUS PEN WITH BALLPOINT PEN**

(75) Inventor: **Takaaki Nakata**, Kuki (JP)

(73) Assignee: **Wacom Co., Ltd.**, Kazo-shi (JP)

(**) Term: **14 Years**

(21) Appl. No.: **29/426,909**

(22) Filed: **Jul. 11, 2012**

(30) **Foreign Application Priority Data**

Mar. 6, 2012 (JP) 2012-005006

(51) **LOC (9) Cl.** **14-02**

(52) **U.S. Cl.** **D14/411**

(58) **Field of Classification Search** D8/61;
D14/411; D19/35, 36, 41-51, 54-58; 401/55,
401/99, 100, 104-107, 196, 197, 202, 208,
401/209, 213, 192, 195, 243; 708/107; 345/179,
345/173; 178/19.01; 700/94

See application file for complete search history.

(56) **References Cited**

U.S. PATENT DOCUMENTS

D279,115 S * 6/1985 Nishida D19/51

(Continued)

FOREIGN PATENT DOCUMENTS

EM 001180046-0015 12/2009

(Continued)

OTHER PUBLICATIONS

“Touch Pen Eingabestift Eingabe Stift Pouch Farbe: Schwarz / Matt-Silber für iPhone 3G, 3GS, 4, 4S, iPad 2, Samsung Galaxy 2 and alle anderen Touchscreen Touch Screen Geräte . . . Marke: Incutex” [translation: “Touch Pen Stylus Input Pen Pouch Color: Black / Matte Silver for iPhone 3G, 3GS, 4, 4S, iPad 2, Samsung Galaxy 2 and All Other Touchscreen Touch Screen Devices . . . Brand: Incutex”], product listing on Amazon.de, <<http://www.amazon.de/Touch-Eingabestift-Eingabe-Stift-Pouch/dp/B007KX4W00/ref=w1>> [retrieved Apr. 12, 2012], 3 pages.

Primary Examiner — Austin Murphy

(74) *Attorney, Agent, or Firm* — Christensen O’Connor Johnson Kindness PLLC

(57) **CLAIM**

I claim the ornamental design for the stylus pen with ballpoint pen, as shown and described.

DESCRIPTION

FIG. 1 is a right side view of the stylus pen with ballpoint pen, wherein the cap is shown covering the writing end of the pen and the stylus end is shown exposed. The left side view of the pen is a mirror image of the right side view;

FIG. 2 is a bottom plan view thereof;

FIG. 3 is a top plan view thereof;

FIG. 4 is a front elevation view thereof;

FIG. 5 is a rear elevation view thereof;

FIG. 6 is an enlarged bottom plan view thereof;

FIG. 7 is an enlarged top plan view thereof;

FIG. 8 is a front bottom right isometric view thereof;

FIG. 9 is a side elevation view of the pen shown in FIG. 1 with the cap removed for convenience, thus exposing the writing end of the pen;

FIG. 10 is a bottom plan view thereof;

FIG. 11 is a top plan view thereof;

FIG. 12 is an enlarged bottom plan view thereof;

FIG. 13 is an enlarged top plan view thereof;

FIG. 14 is a right side view of the cap of the pen shown in FIG. 1. The left side view of the cap is a mirror image of the right side view;

FIG. 15 is a bottom plan view of FIG. 14;

FIG. 16 is a front elevation view of FIG. 14;

FIG. 17 is a rear elevation view of FIG. 14;

FIG. 18 is an enlarged bottom plan view of FIG. 15; and,

FIG. 19 is a right side elevation view of the pen shown in FIG. 1. The cap is shown removed from the writing end and is shown covering the stylus end of the pen. The left side view of FIG. 19 is a mirror image of the right side view.

The broken lines shown in FIGS. 15 and 18 illustrate environmental subject matter and form no part of the claimed design.

1 Claim, 5 Drawing Sheets

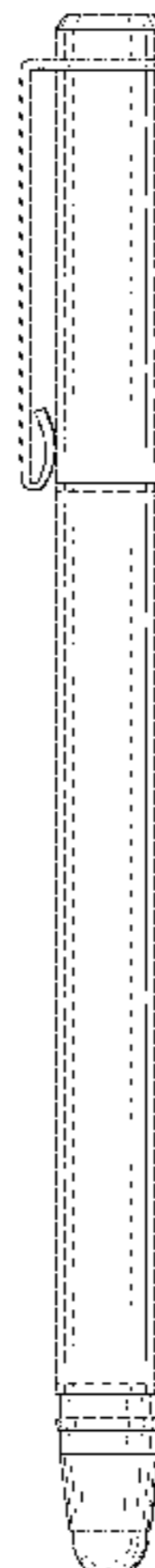

US D669,896 S

Page 2

U.S. PATENT DOCUMENTS

D316,726 S * 5/1991 Itoh D19/51
D321,207 S * 10/1991 Granoff D19/49
D333,133 S * 2/1993 Hirota D14/411
D357,676 S * 4/1995 Mundt et al. D14/411
D390,872 S * 2/1998 Sunaga D19/36
D395,672 S * 6/1998 Navarro D19/48
D395,673 S * 6/1998 Baubil D19/51
D458,635 S * 6/2002 Boyle et al. D19/36

D595,352 S * 6/2009 Ikeda D19/48
D644,227 S * 8/2011 Son D14/411
D655,292 S * 3/2012 Nakata D14/411
D659,141 S * 5/2012 Watson D14/411

FOREIGN PATENT DOCUMENTS

JP 664638 S 11/1985

* cited by examiner

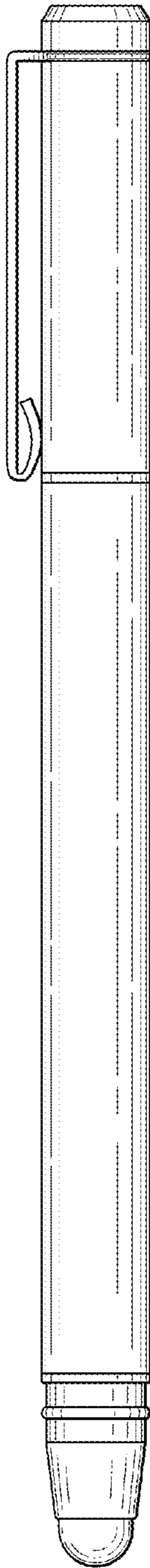

Fig. 1.

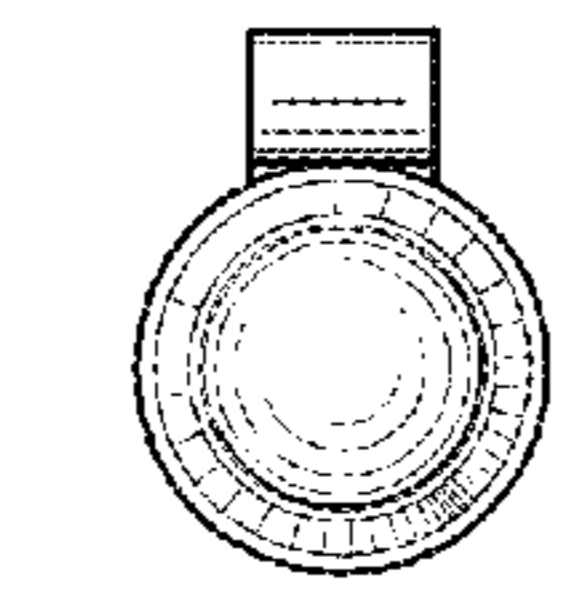

Fig. 2.

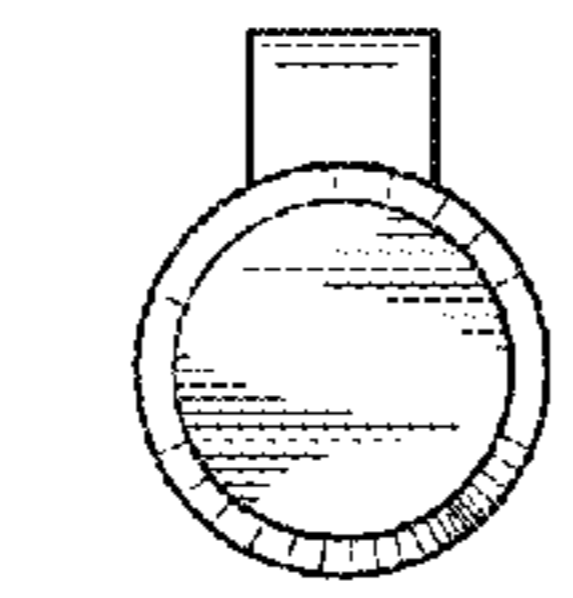

Fig. 3.

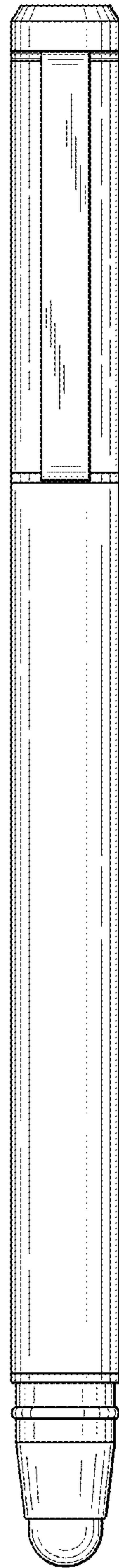
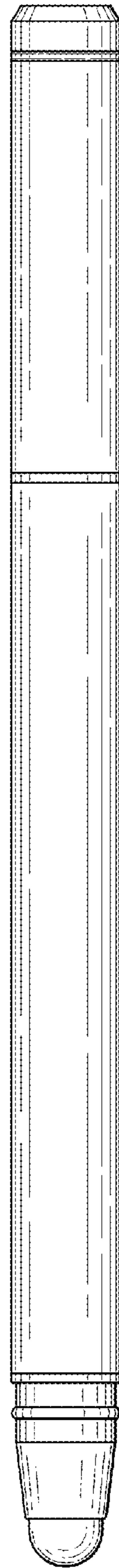

Fig. 4.

Fig. 5.



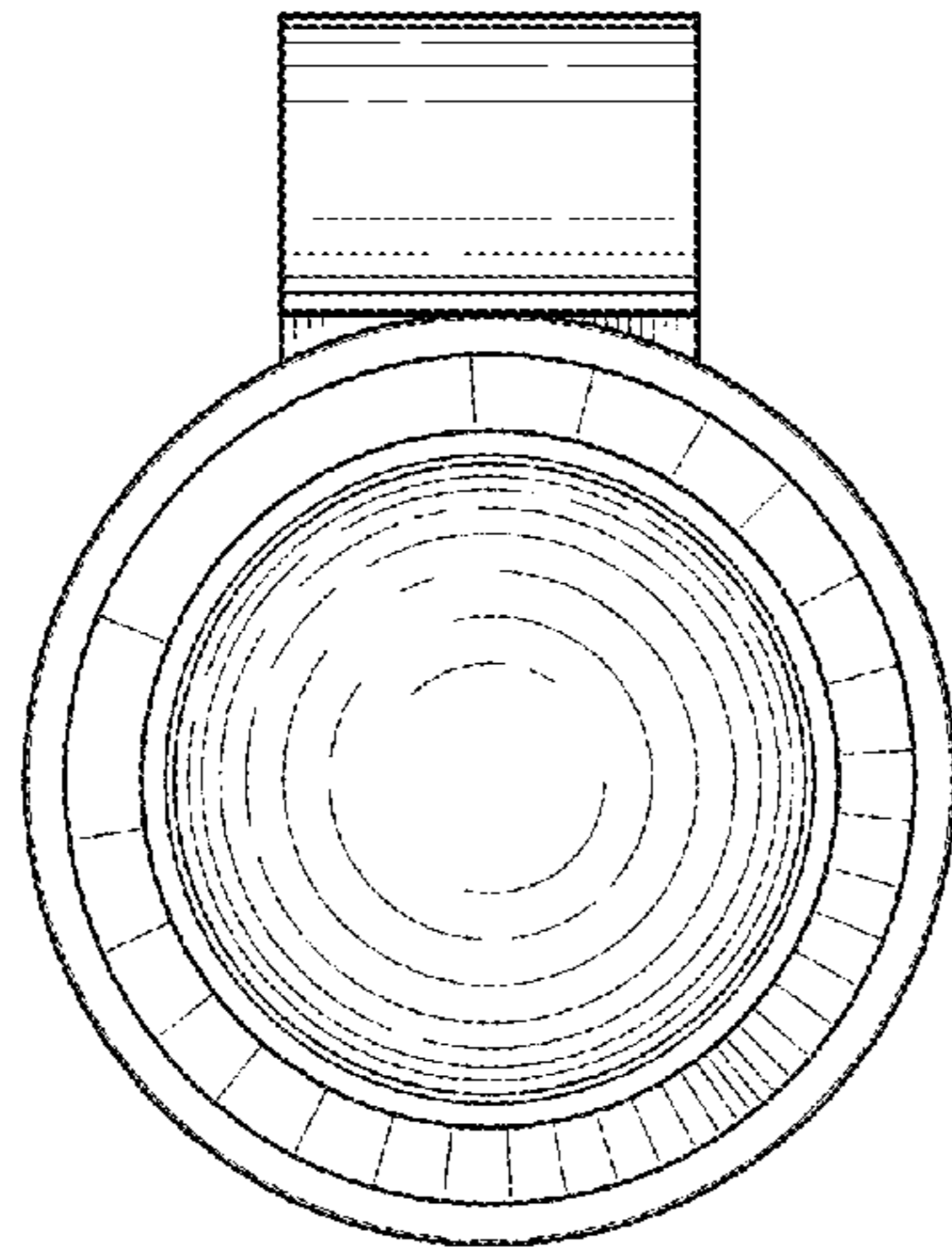

Fig. 6.

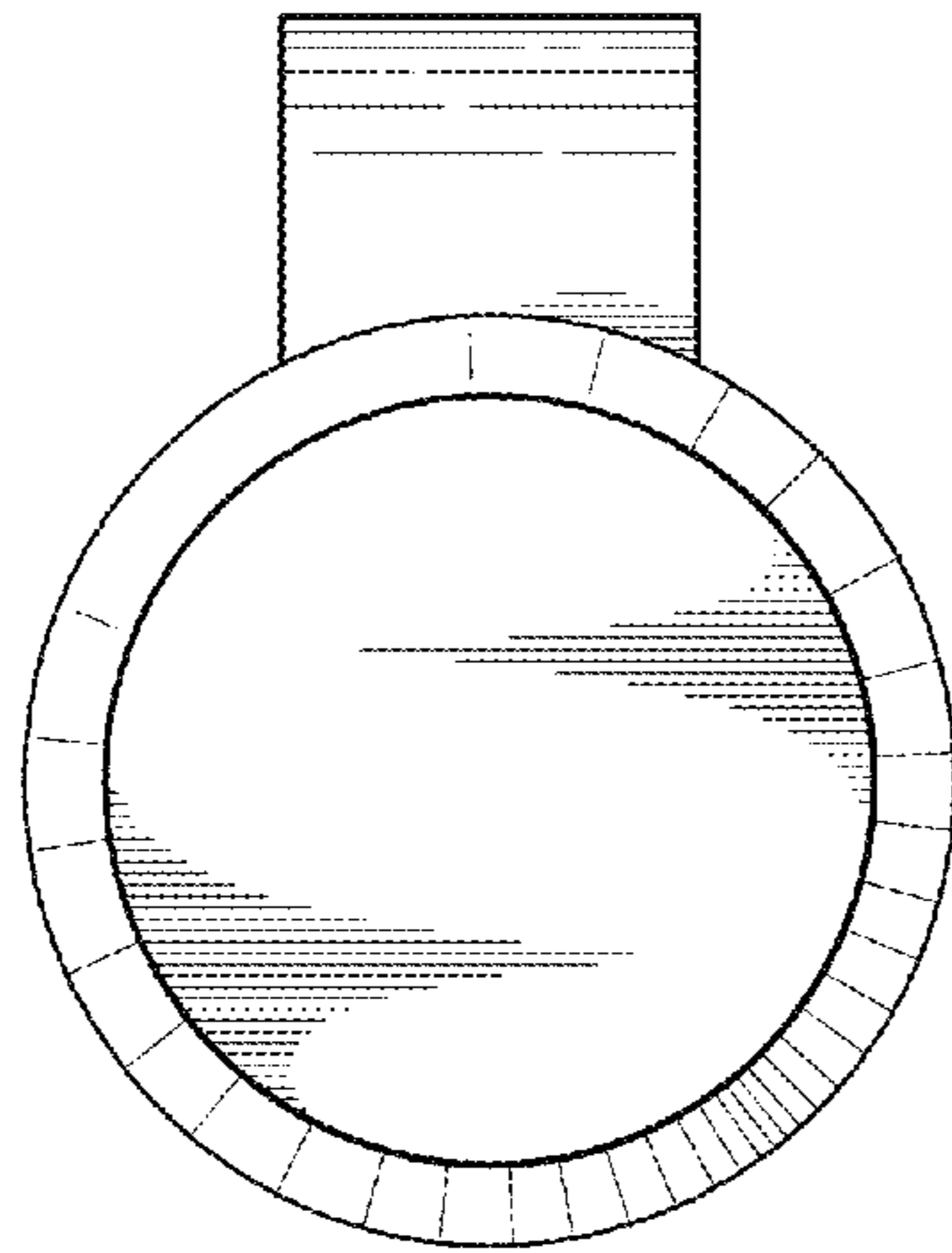

Fig. 7.

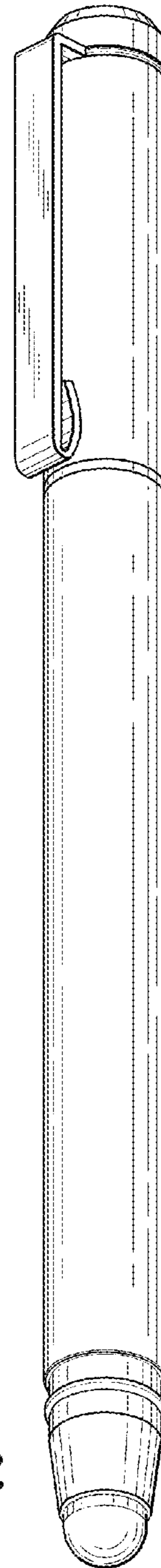

Fig. 8.

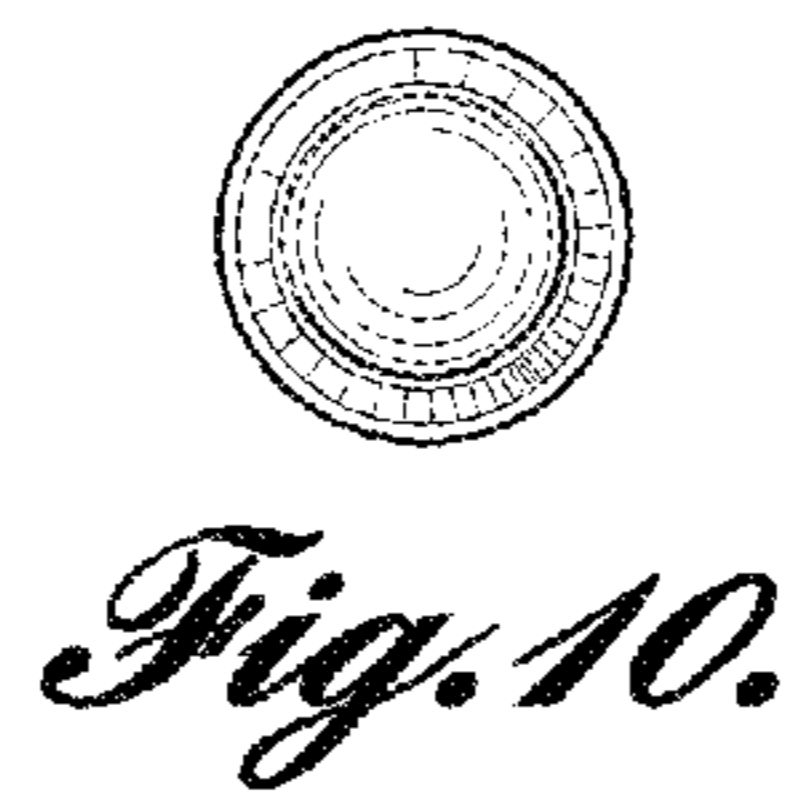
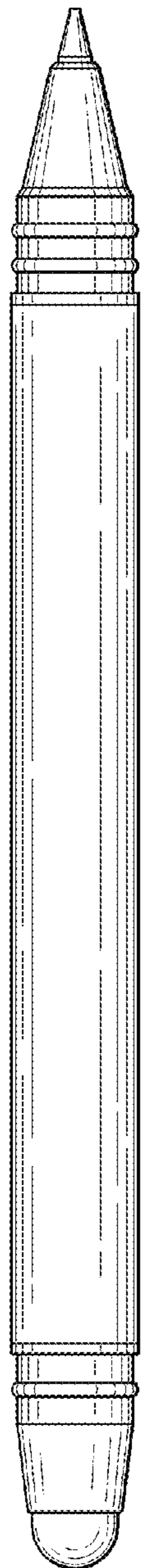

Fig. 10.

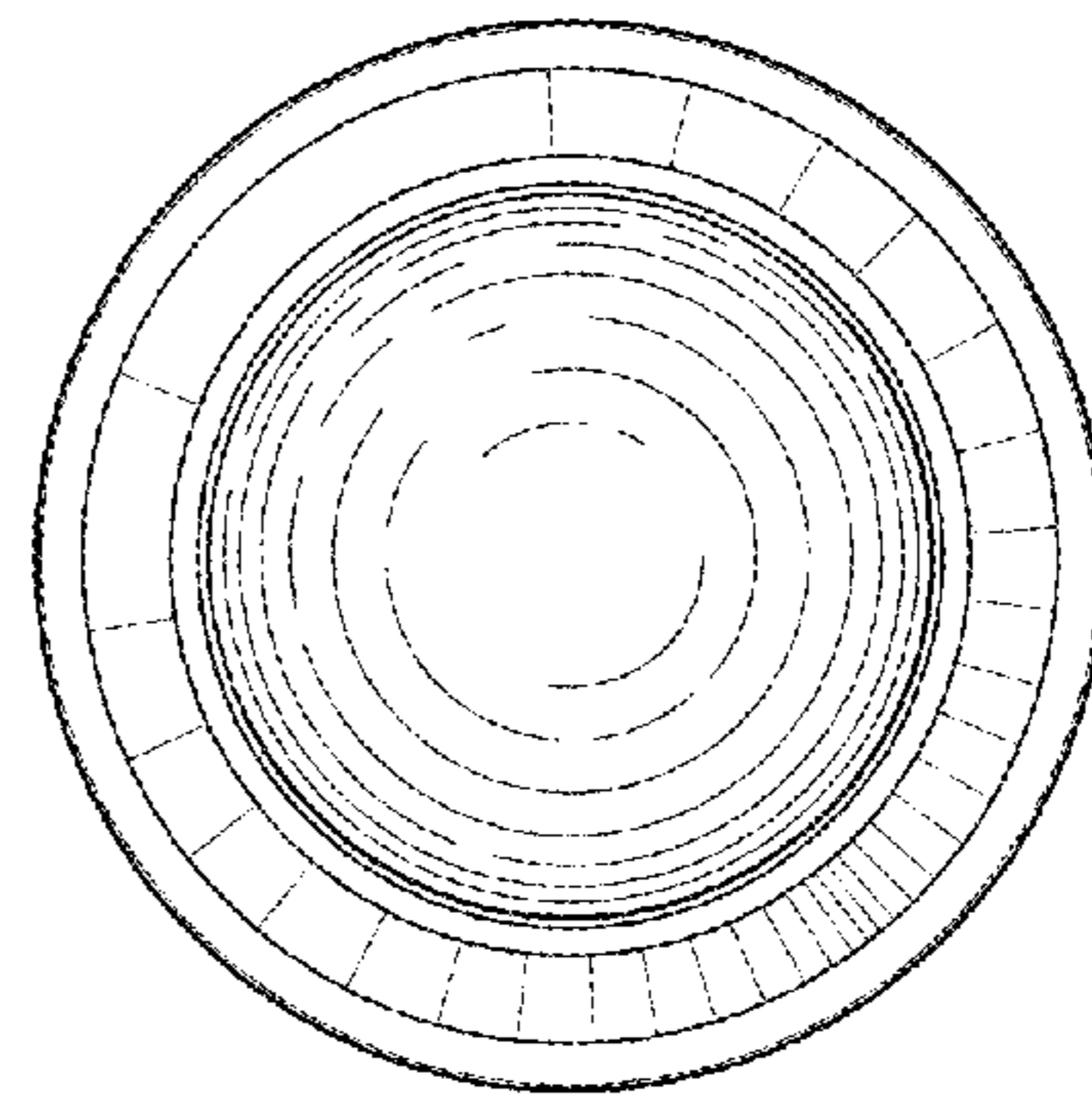

Fig. 12.

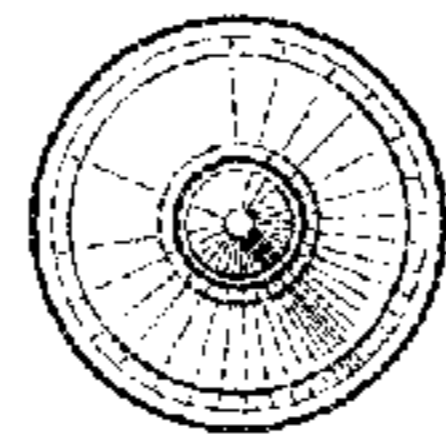

Fig. 11.

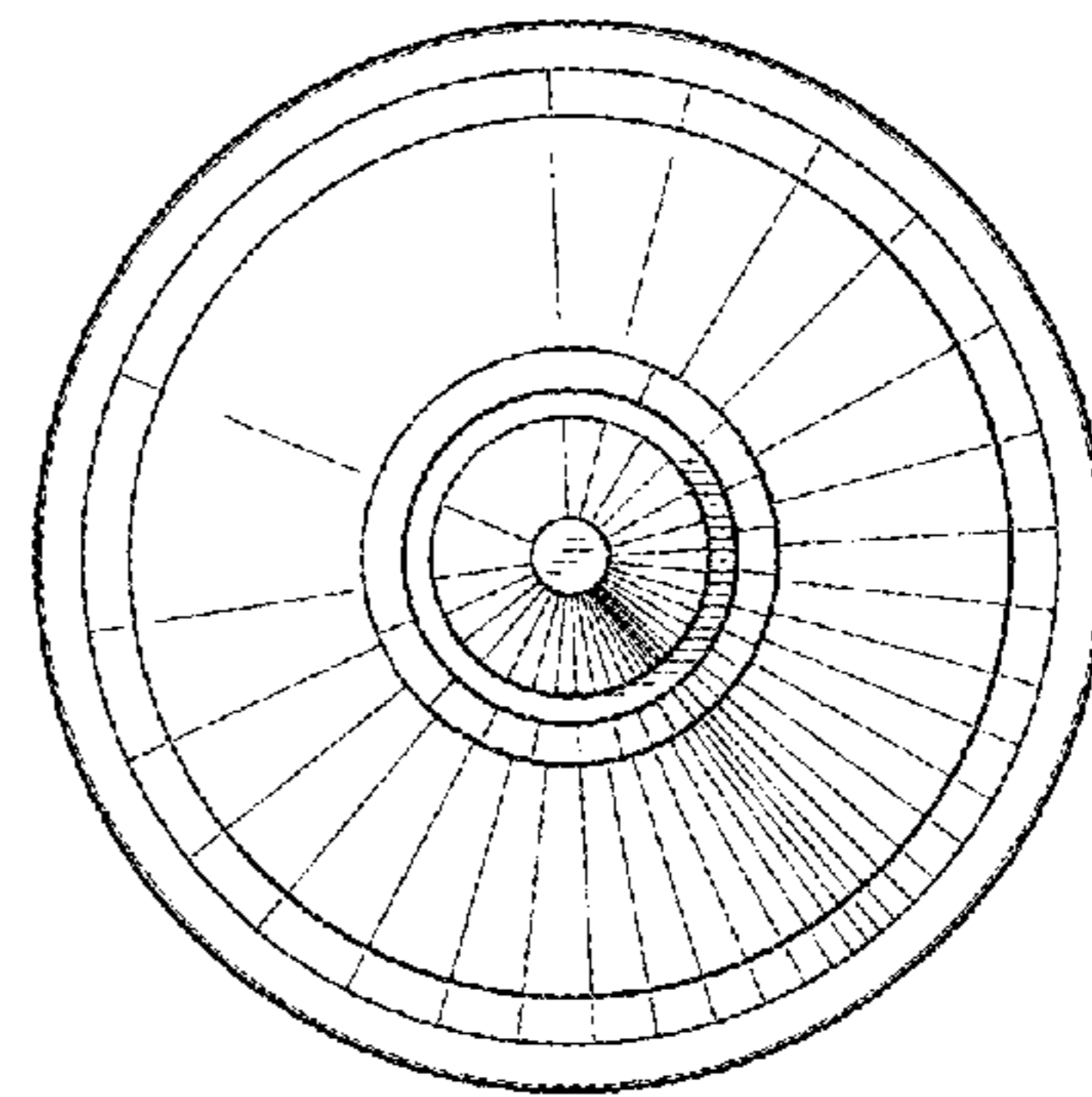

Fig. 13.

Fig. 9.

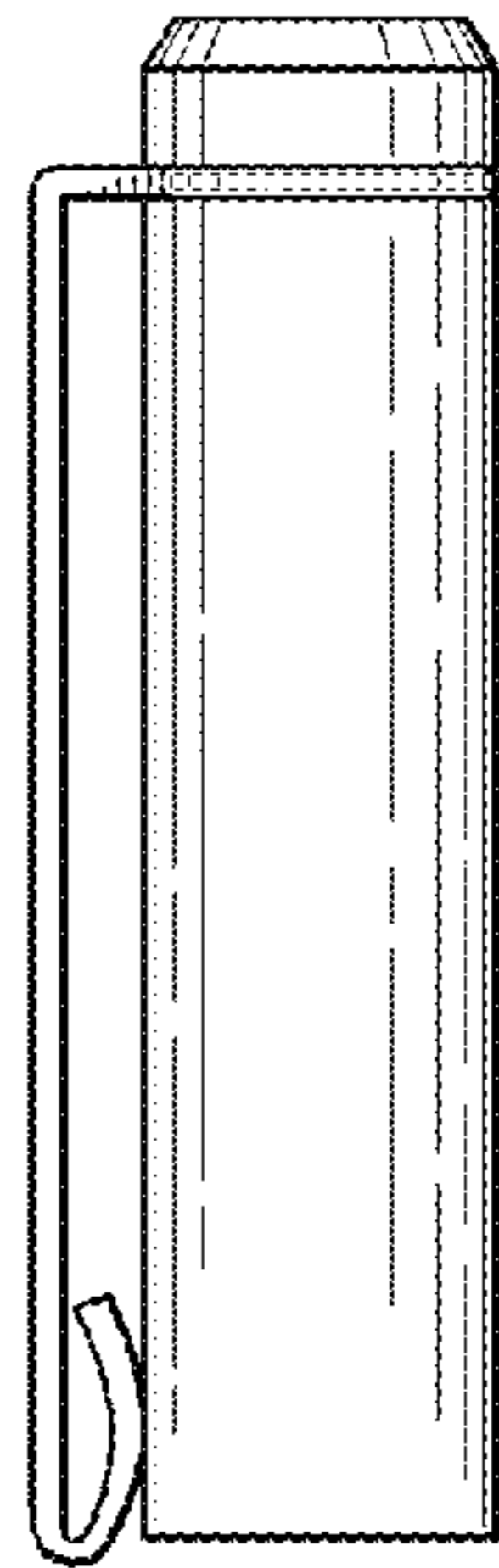

Fig. 14.

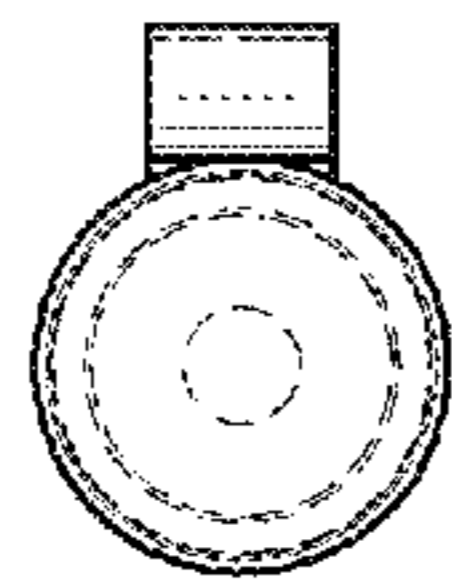

Fig. 15.

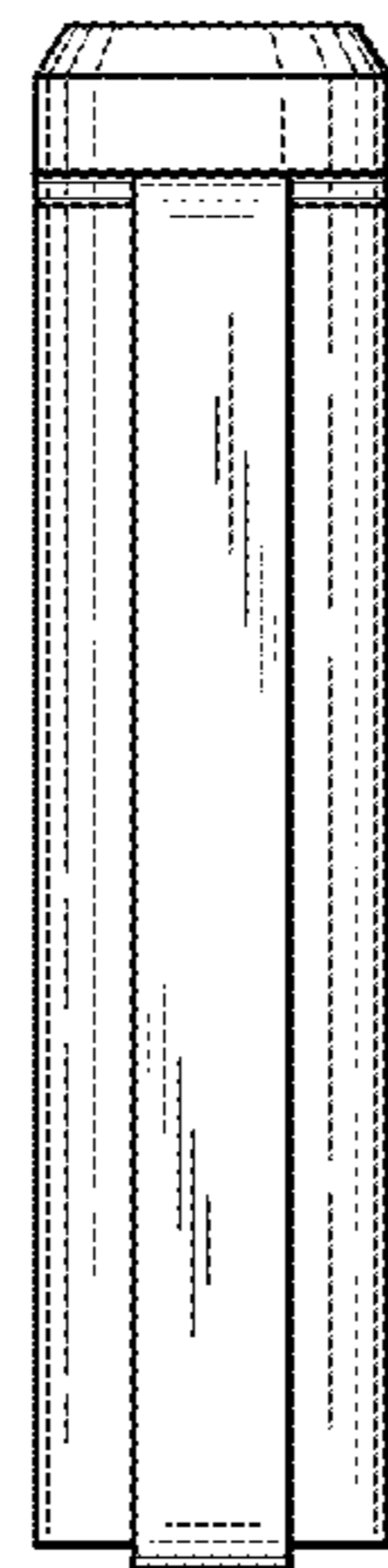

Fig. 16.

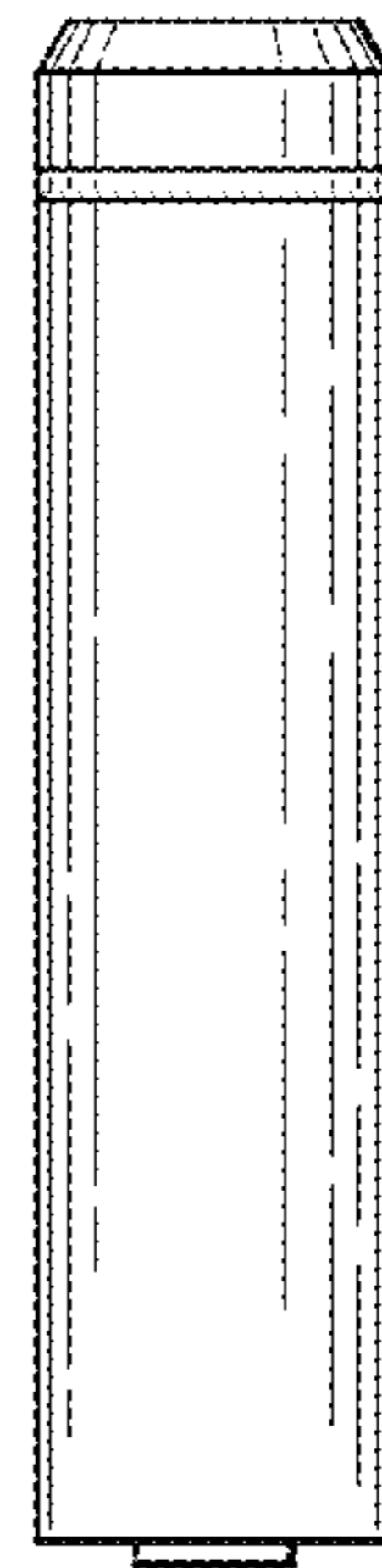

Fig. 17.

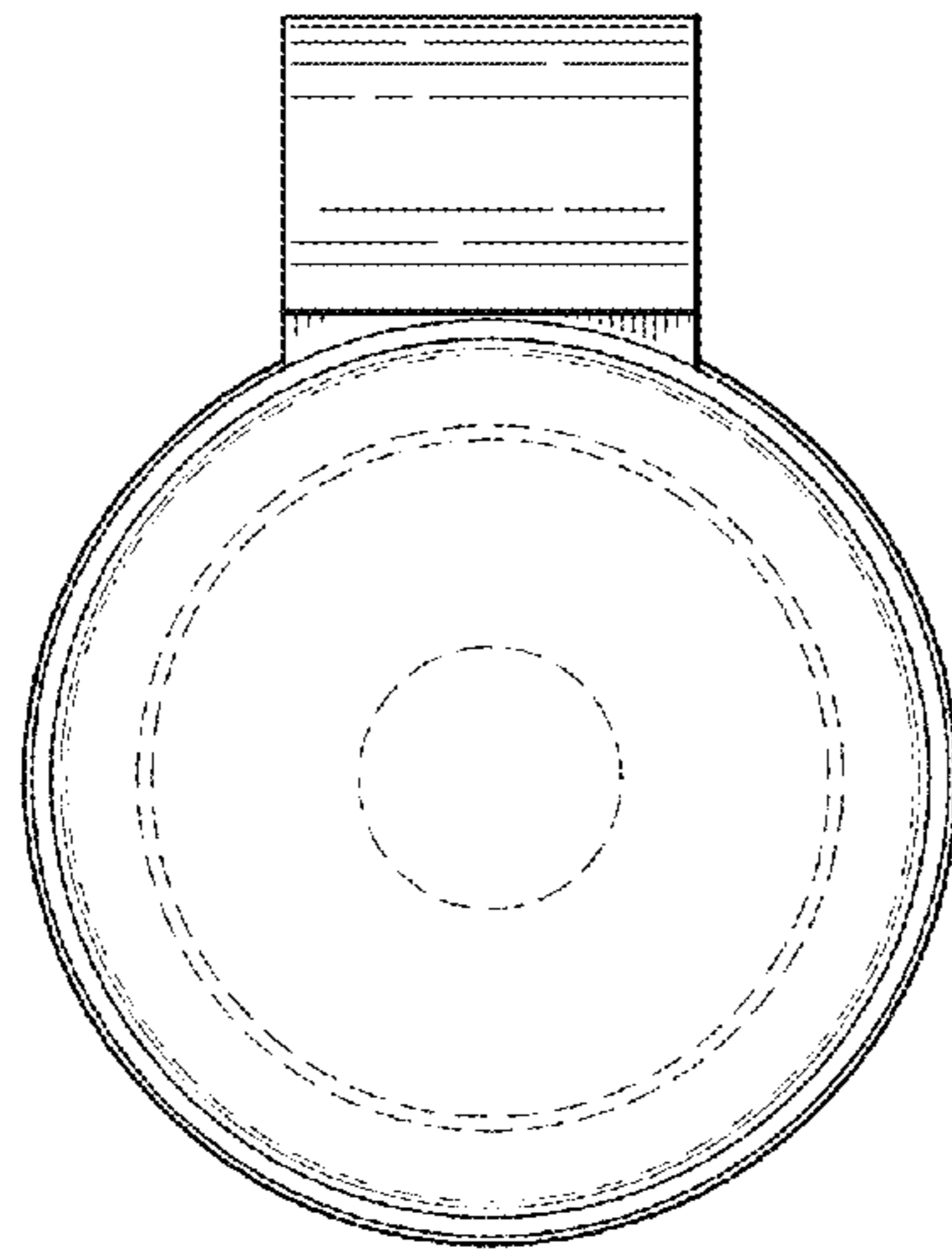

Fig. 18.

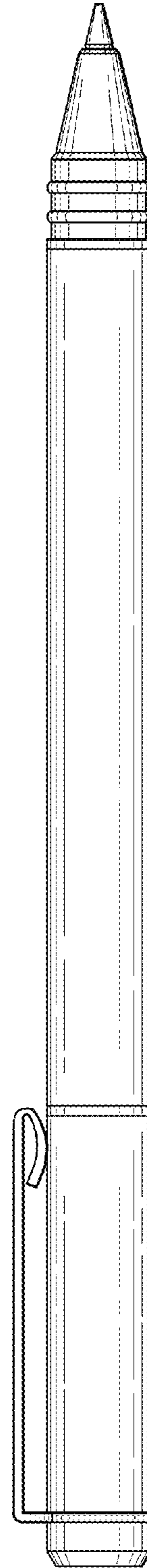

Fig. 19.

UNITED STATES PATENT AND TRADEMARK OFFICE
CERTIFICATE OF CORRECTION

PATENT NO. : D669,896 S
APPLICATION NO. : 29/426909
DATED : October 30, 2012
INVENTOR(S) : T. Nakata

Page 1 of 1

It is certified that error appears in the above-identified patent and that said Letters Patent is hereby corrected as shown below:

On the Title Page

<u>COLUMN</u>	<u>LINE</u>	<u>ERROR</u>
Item (57)	Description line 20 of text	“The the left side” should read --The left side--

Signed and Sealed this
Tenth Day of December, 2013

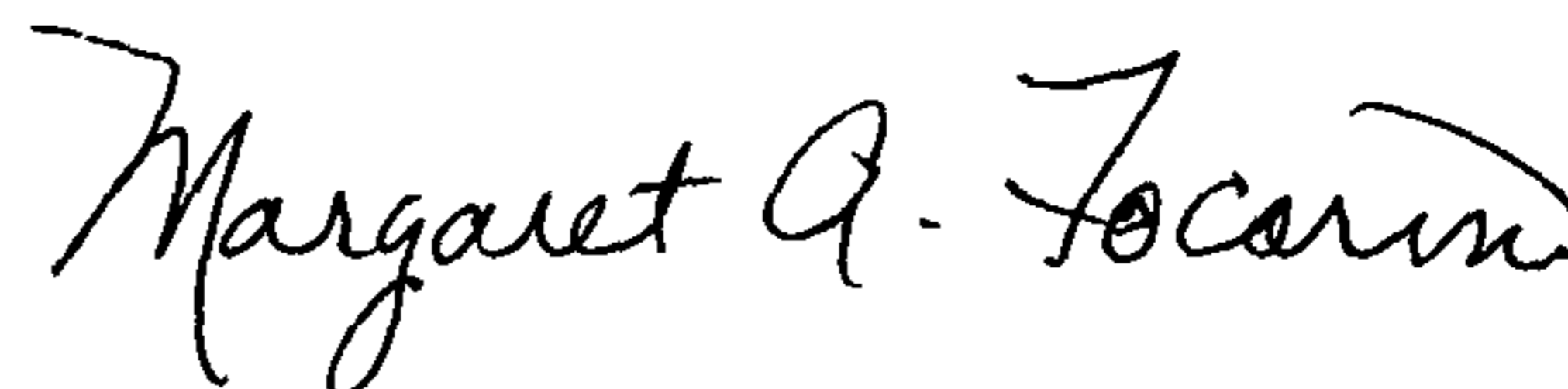

Margaret A. Focarino
Commissioner for Patents of the United States Patent and Trademark Office