

US00D669817S

(12) **United States Design Patent**  
**Dubow**

(10) **Patent No.:** **US D669,817 S**

(45) **Date of Patent:** **\*\* Oct. 30, 2012**

(54) **HOUSE CORK CAGE ORNAMENT**

D309,429 S \* 7/1990 Grimm ..... D3/271.1  
D617,611 S \* 6/2010 DuBow ..... D7/628

(75) Inventor: **Ardeen Dubow**, Santa Ana, CA (US)

\* cited by examiner

(73) Assignee: **Epic Products, Inc.**, Santa Ana, CA (US)

*Primary Examiner* — T. Chase Nelson  
*Assistant Examiner* — Michelle E Wilson

(\*\*) Term: **14 Years**

(74) *Attorney, Agent, or Firm* — Nath, Goldberg & Meyer;  
Jerald L. Meyer; Robert T. Burns

(21) Appl. No.: **29/412,491**

(57) **CLAIM**

The ornamental design for a house cork cage ornament, as shown and described.

(22) Filed: **Feb. 3, 2012**

(51) **LOC (9) Cl.** ..... **11-02**

(52) **U.S. Cl.** ..... **D11/157**

(58) **Field of Classification Search** ..... D11/130,  
D11/157, 164, 184; D7/560, 564, 563, 571,  
D7/628, 604, 606, 625, 601; D9/681, 600;  
D3/270, 271.1; 206/206

See application file for complete search history.

**DESCRIPTION**

FIG. 1 is a perspective view of a house cork cage ornament showing my new design;  
FIG. 2 is a front elevation view thereof;  
FIG. 3 is a back elevation view thereof;  
FIG. 4 is a left side elevation view thereof;  
FIG. 5 is a right side elevation view thereof;  
FIG. 6 is a top view thereof; and,  
FIG. 7 is a bottom view thereof.

The broken line showing of the text on the house cork cage label forms no part of the claimed design.

(56) **References Cited**

**U.S. PATENT DOCUMENTS**

D287,650 S \* 1/1987 Braeuner ..... D30/110  
D309,047 S \* 7/1990 Small ..... D30/114

**1 Claim, 4 Drawing Sheets**

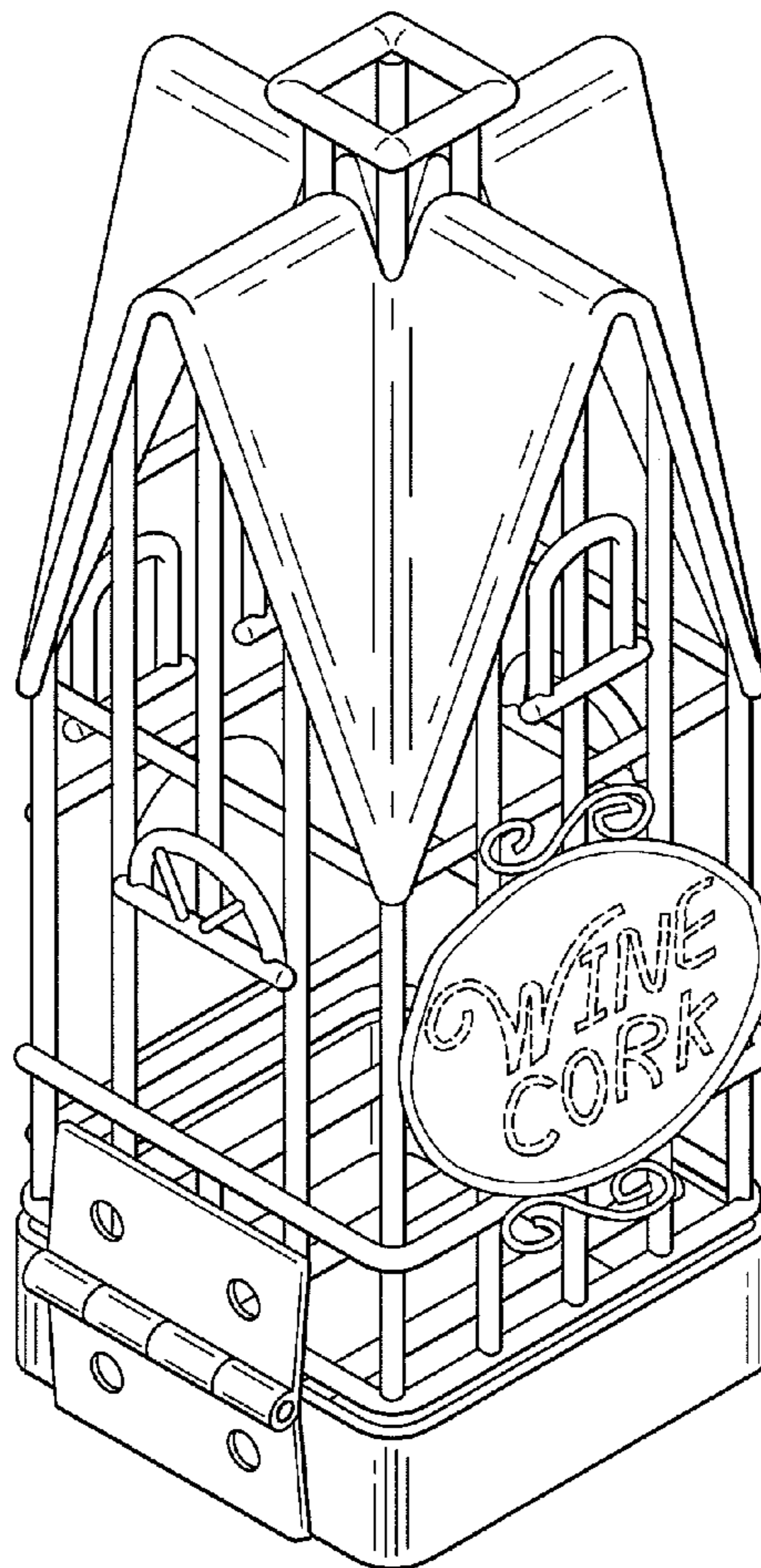

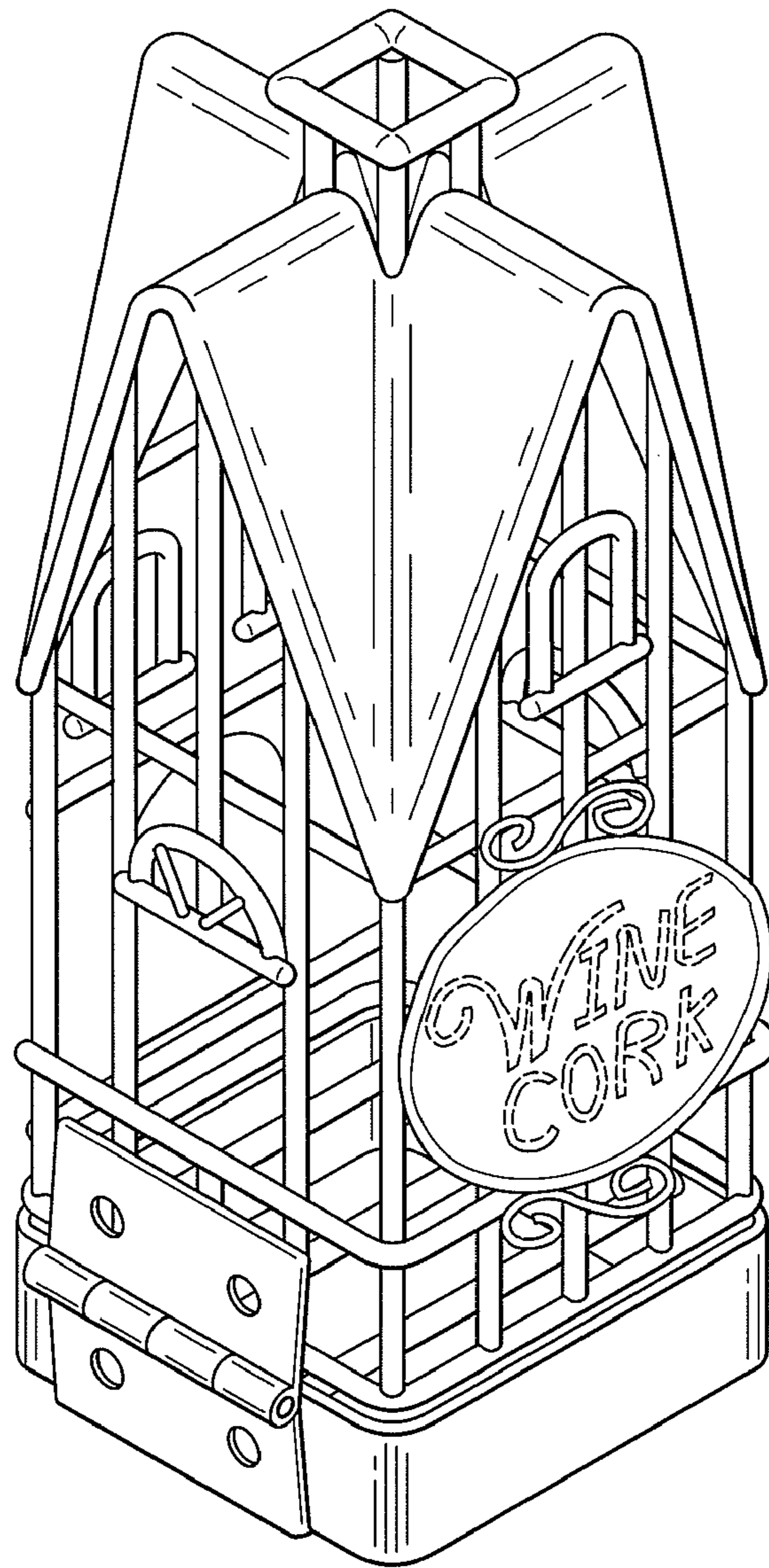

FIG. 1

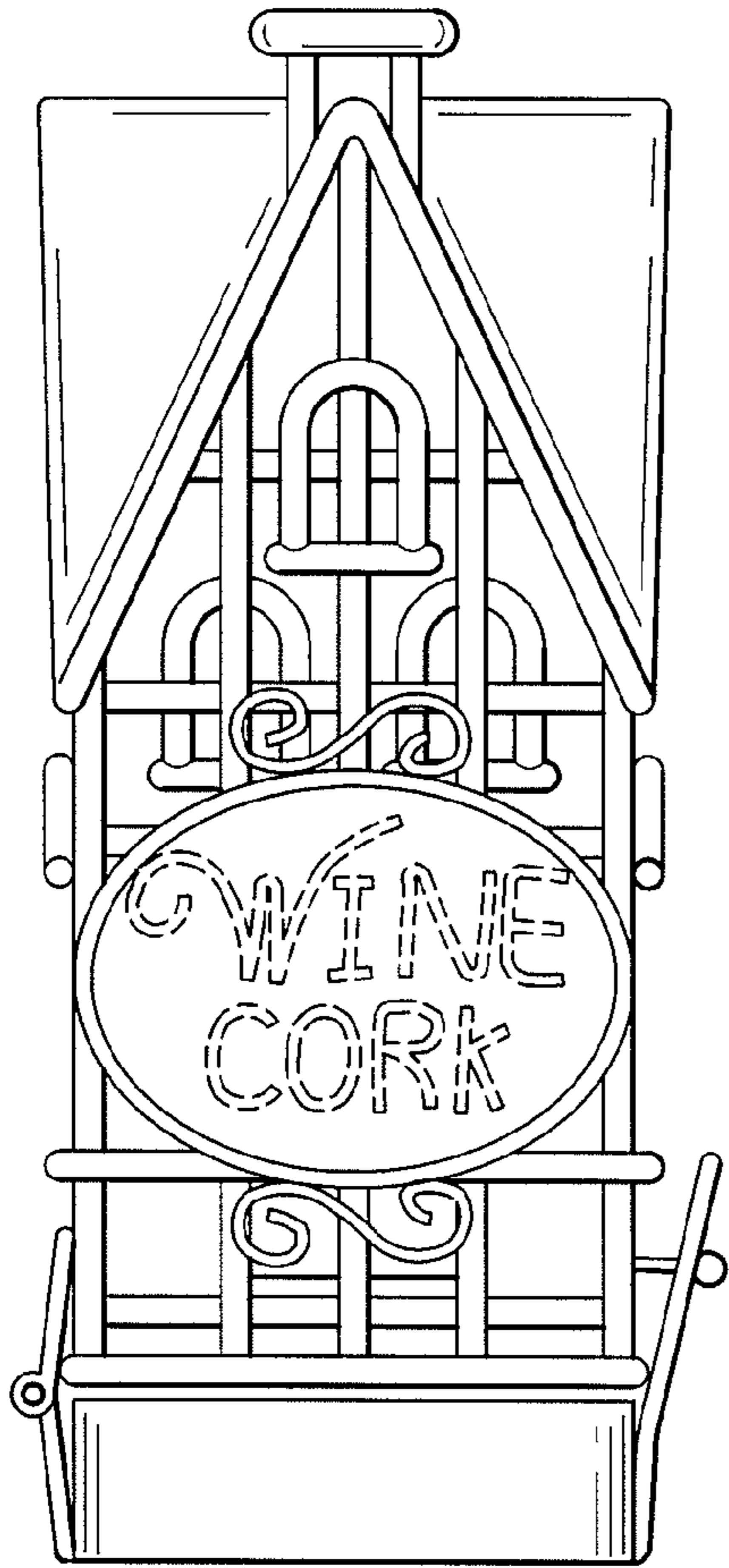

FIG. 2

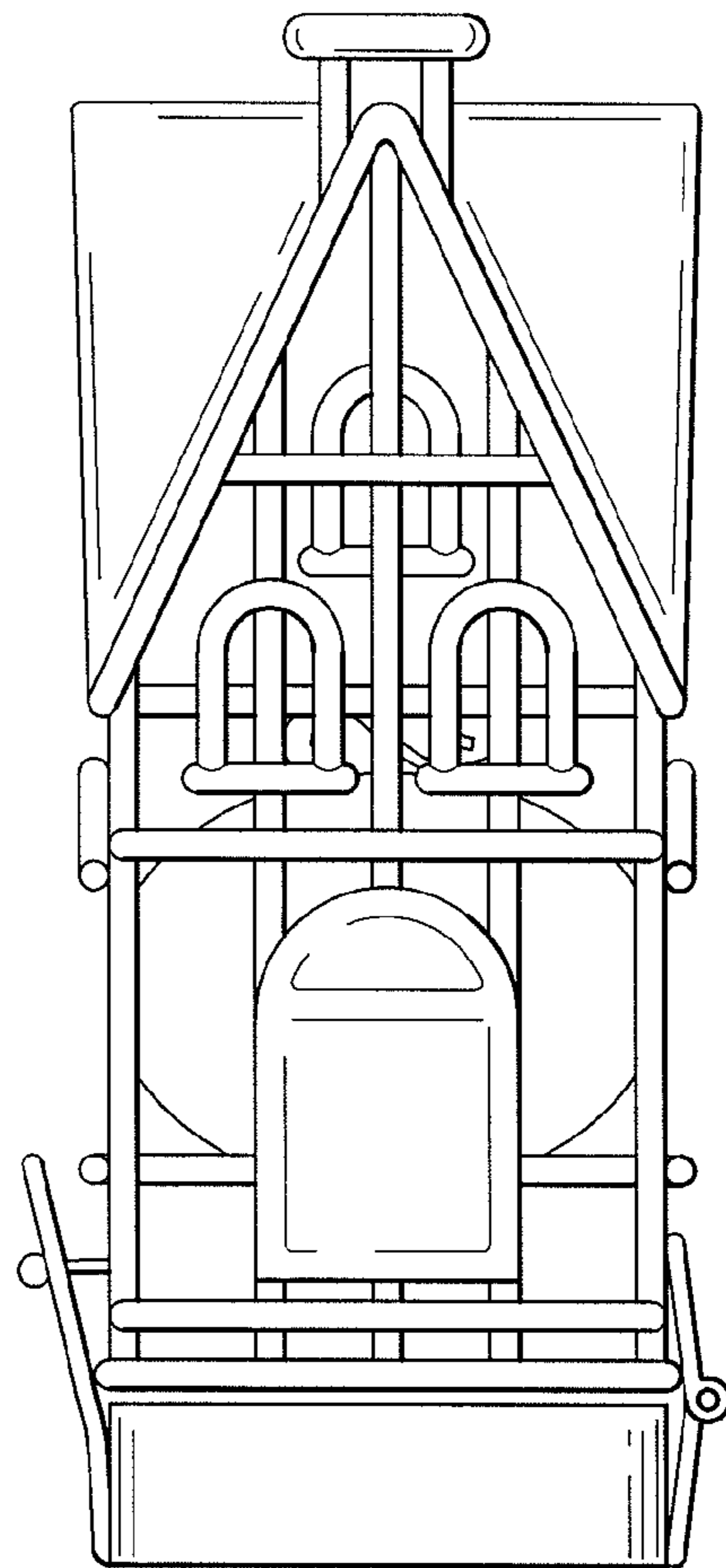

FIG. 3

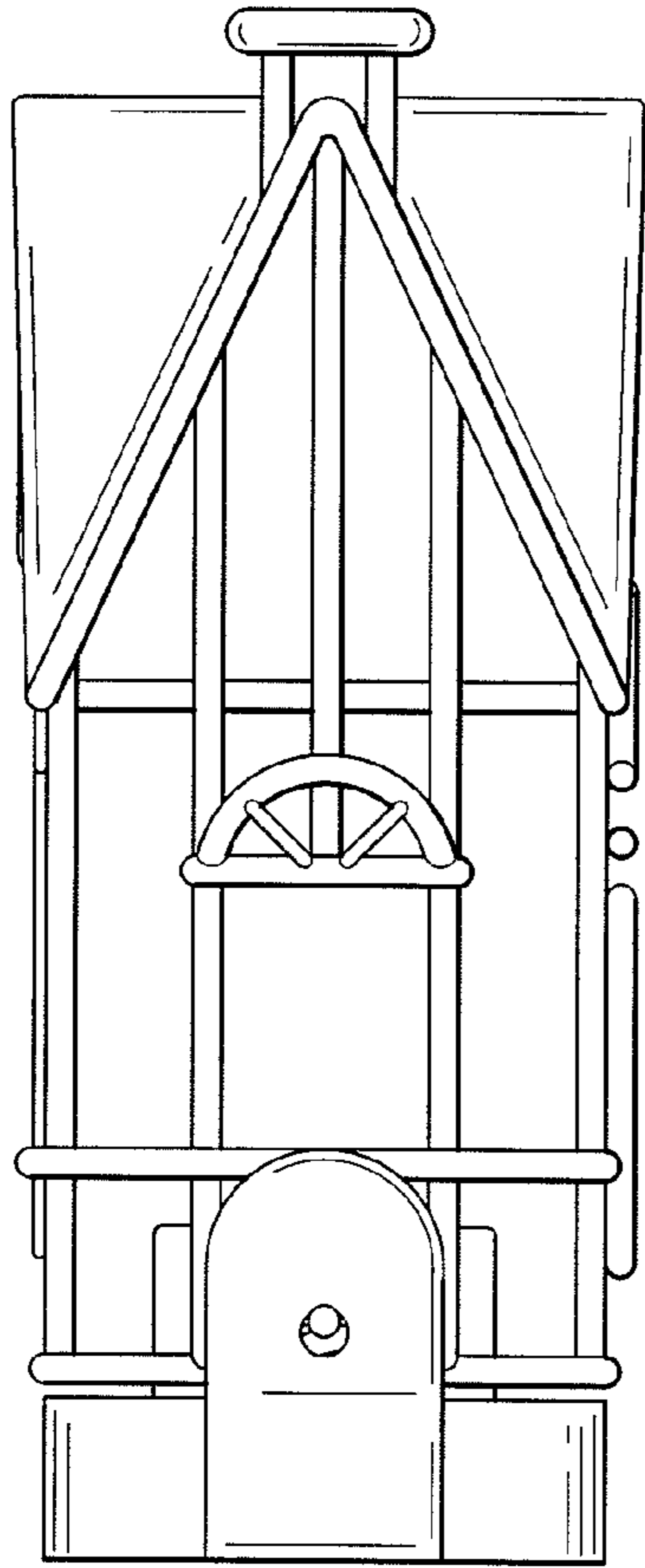

FIG. 4

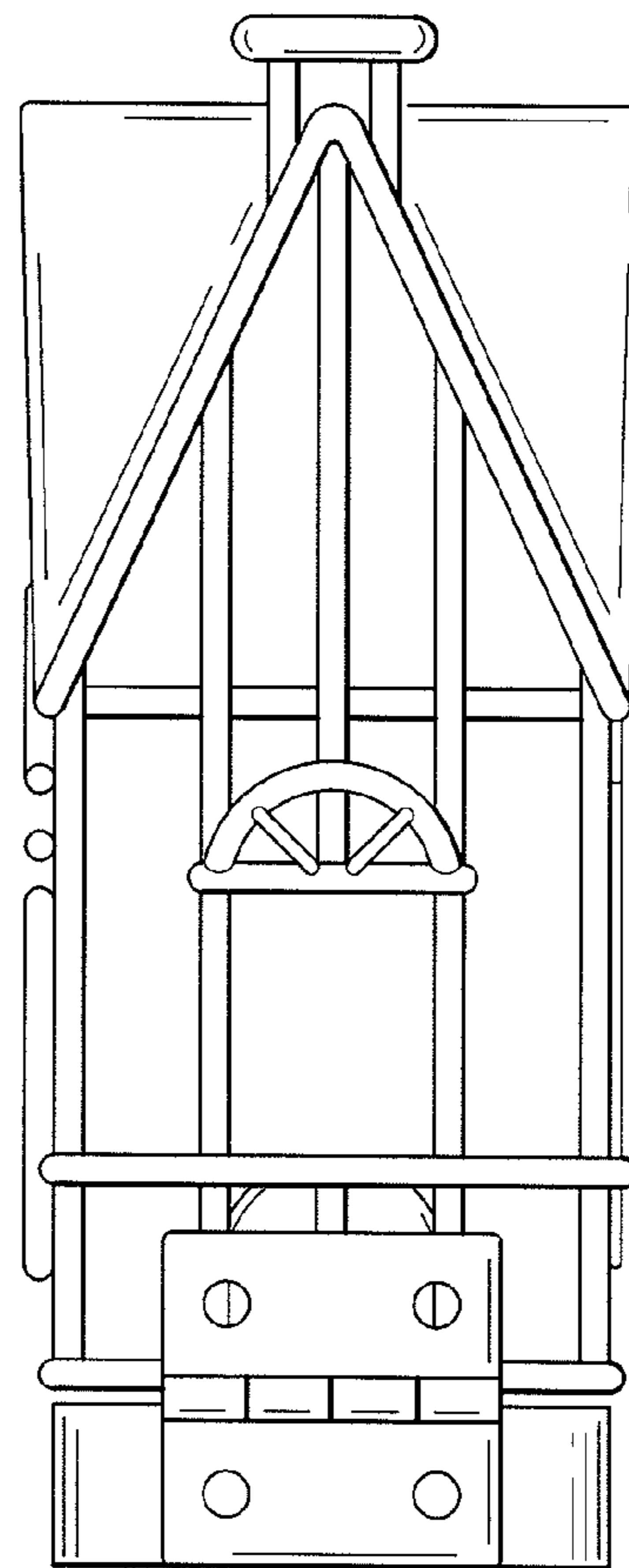

FIG. 5

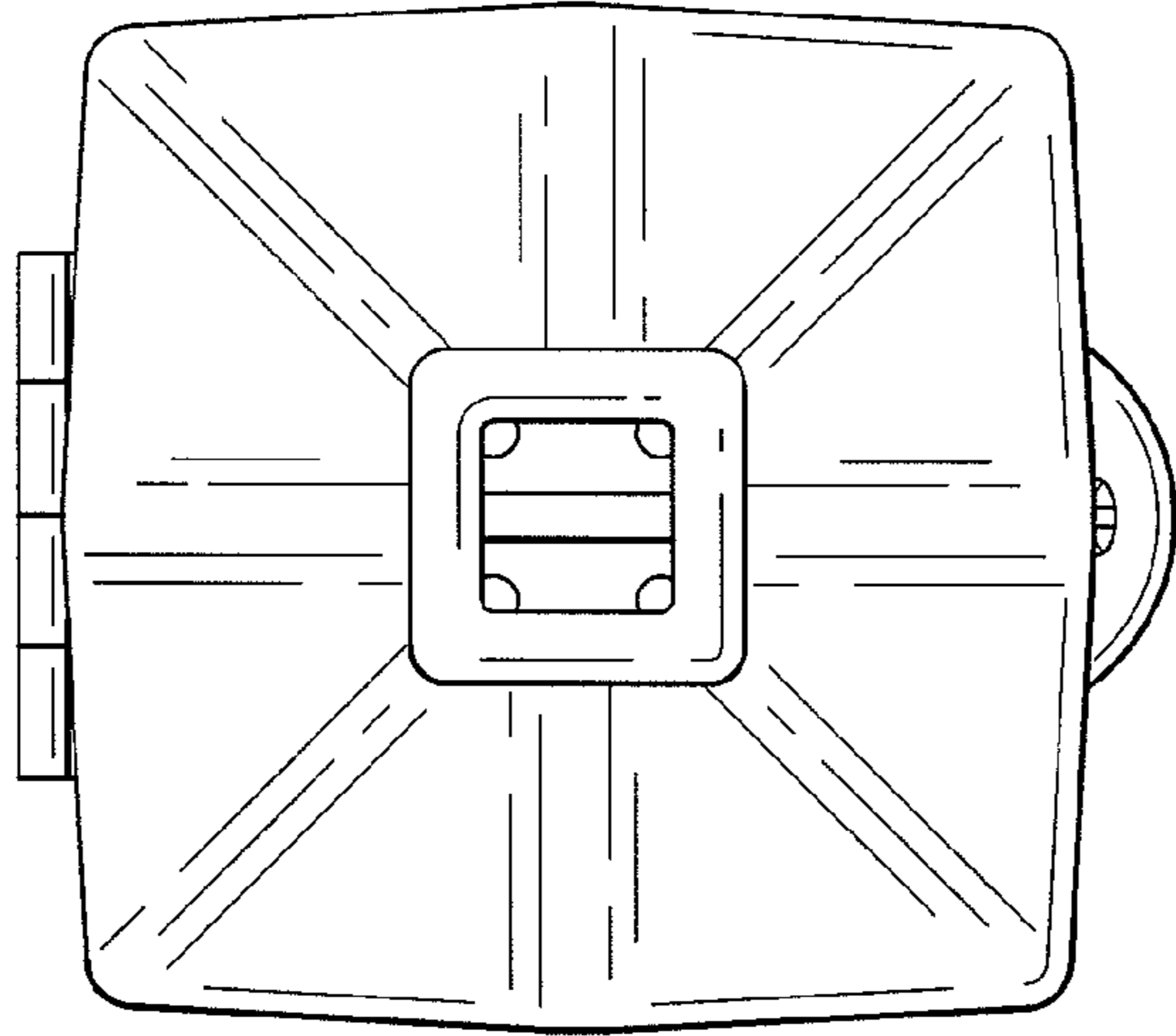

FIG. 6

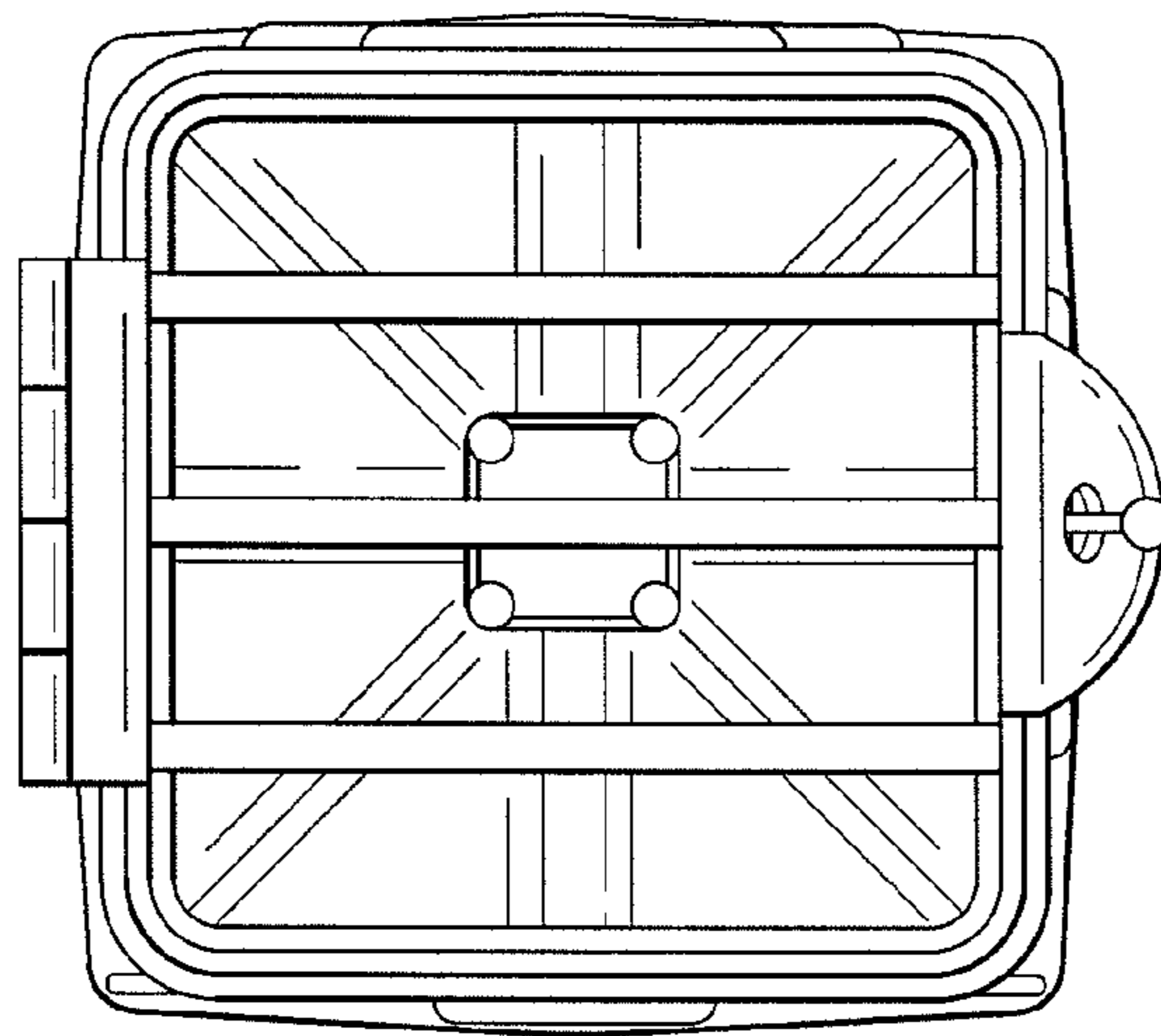

FIG. 7