

US00D669747S

(12) **United States Design Patent**
Scharf et al.

(10) **Patent No.:** **US D669,747 S**

(45) **Date of Patent:** **** Oct. 30, 2012**

(54) **HERB GRINDER**

(74) *Attorney, Agent, or Firm* — Fulwider Patton LLP

(75) Inventors: **Eitam Scharf**, Long Beach, CA (US);
Kimberly Dian Grant, Long Beach, CA
(US)

(57) **CLAIM**
The ornamental design for a herb grinder, as shown and described.

(73) Assignee: **The Violina Syndicate, LLC**, Los Alamitos, CA (US)

DESCRIPTION

(**) Term: **14 Years**

(21) Appl. No.: **29/407,899**

FIG. 1 is a perspective view of a herb grinder showing our new design;

(22) Filed: **Dec. 2, 2011**

(51) **LOC (9) Cl.** **07-04**

FIG. 2 is a front view thereof;

(52) **U.S. Cl.** **D7/678**

FIG. 3 is a rear view thereof;

(58) **Field of Classification Search** D7/678,
D7/672-677, 381-385, 412; 241/92-95,
241/100, 168, 169, 169.1, 273.1-273.4, 30,
241/33, 36, 37.5; 99/495, 510; 30/114, 278,
30/279.6, 287, 286, 280, 383, 389-391

FIG. 4 is a bottom view thereof; the top view being a mirror image;

See application file for complete search history.

FIG. 5 is a left side view thereof, the right side view being a mirror image;

(56) **References Cited**

U.S. PATENT DOCUMENTS

1,845,522	A *	2/1932	Rowley	241/168
D167,270	S *	7/1952	Marcus	D7/678
D347,979	S *	6/1994	Feer et al.	D7/678
5,711,491	A *	1/1998	Molo	241/95
6,082,645	A *	7/2000	Himmighofen et al.	241/168
D447,022	S *	8/2001	Wong	D7/678
D447,391	S *	9/2001	Bodum	D7/678
6,318,652	B1 *	11/2001	Liu	241/95
D480,613	S *	10/2003	Wong	D7/693
6,860,441	B2 *	3/2005	Richardson	241/95

* cited by examiner

FIG. 6 is an enlarged sectional view thereof, taken along the line 6-6 of FIG. 2;

FIG. 7 is a perspective view of a second embodiment of the design shown in FIG. 1;

FIG. 8 is a front view of the embodiment shown in FIG. 7;

FIG. 9 is a rear view of the embodiment shown in FIG. 7;

FIG. 10 is a bottom view of the embodiment shown in FIG. 7, the top view being a mirror image;

FIG. 11 is a left side view of the embodiment shown in FIG. 7, the right side view being a mirror image;

FIG. 12 is an enlarged sectional view of the embodiment shown in FIG. 7, taken along the line 12-12 of FIG. 8;

FIG. 13 is a perspective view of a third embodiment of the design shown in FIG. 1;

FIG. 14 is a front view of the embodiment shown in FIG. 13;

FIG. 15 is a rear view of the embodiment shown in FIG. 13;

FIG. 16 is a bottom view of the embodiment shown in FIG. 13, the top view being a mirror image;

FIG. 17 is a left side view of the embodiment shown in FIG. 13, the right side view being a mirror image; and,

FIG. 18 is an enlarged sectional view of the embodiment shown in FIG. 13, taken along the line 18-18 of FIG. 14.

Primary Examiner — Terry Wallace

1 Claim, 6 Drawing Sheets

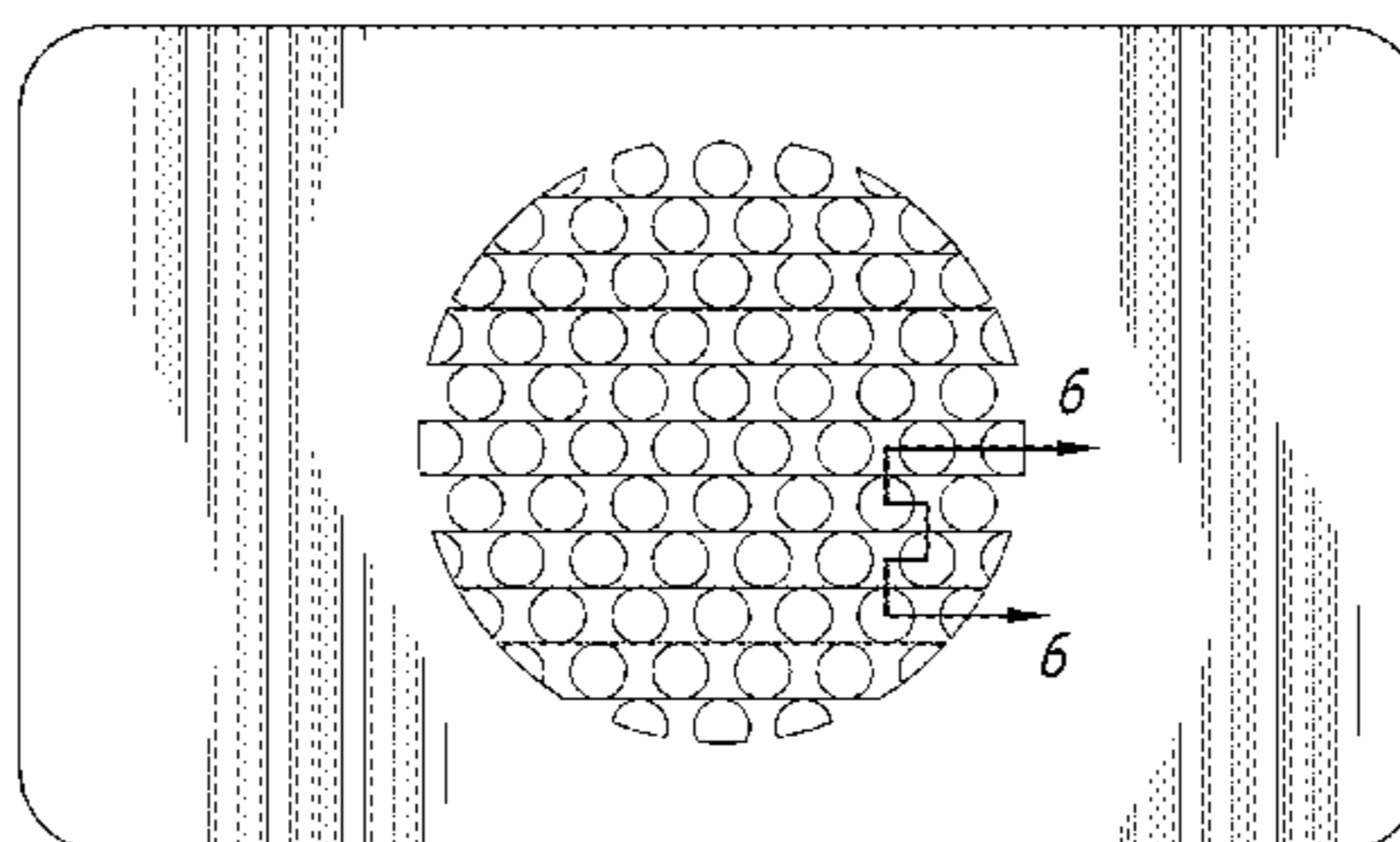
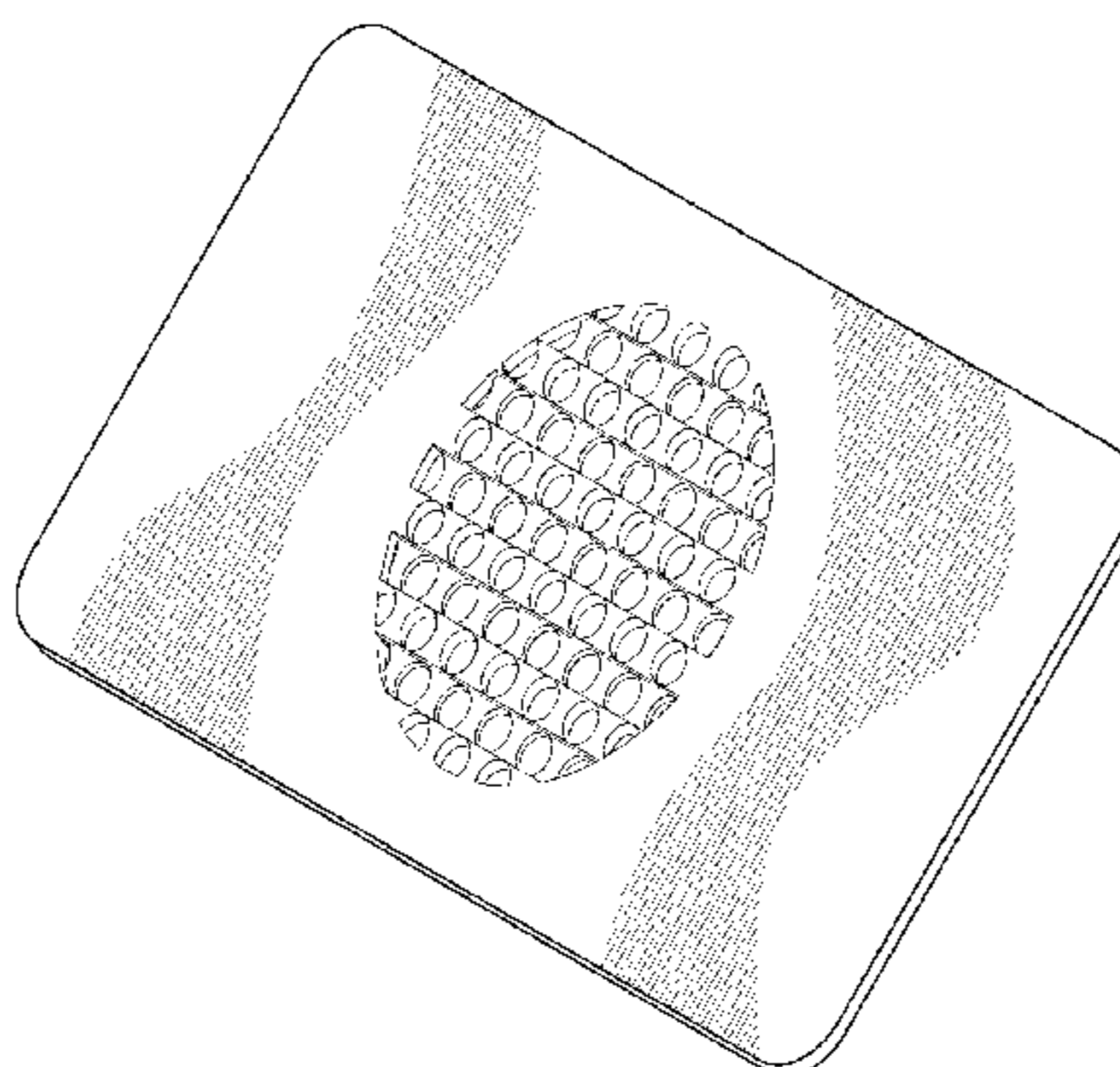

FIG. 1

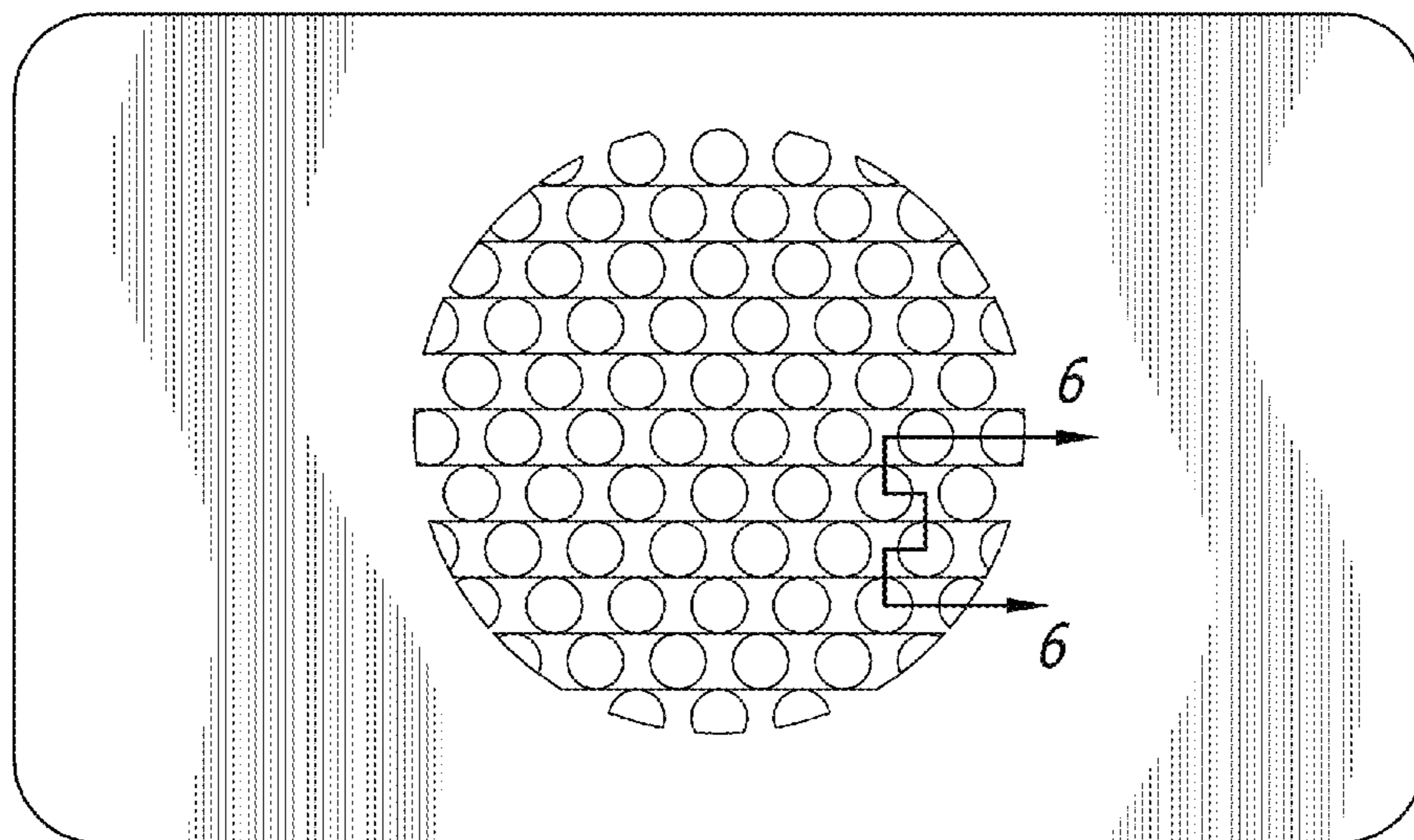
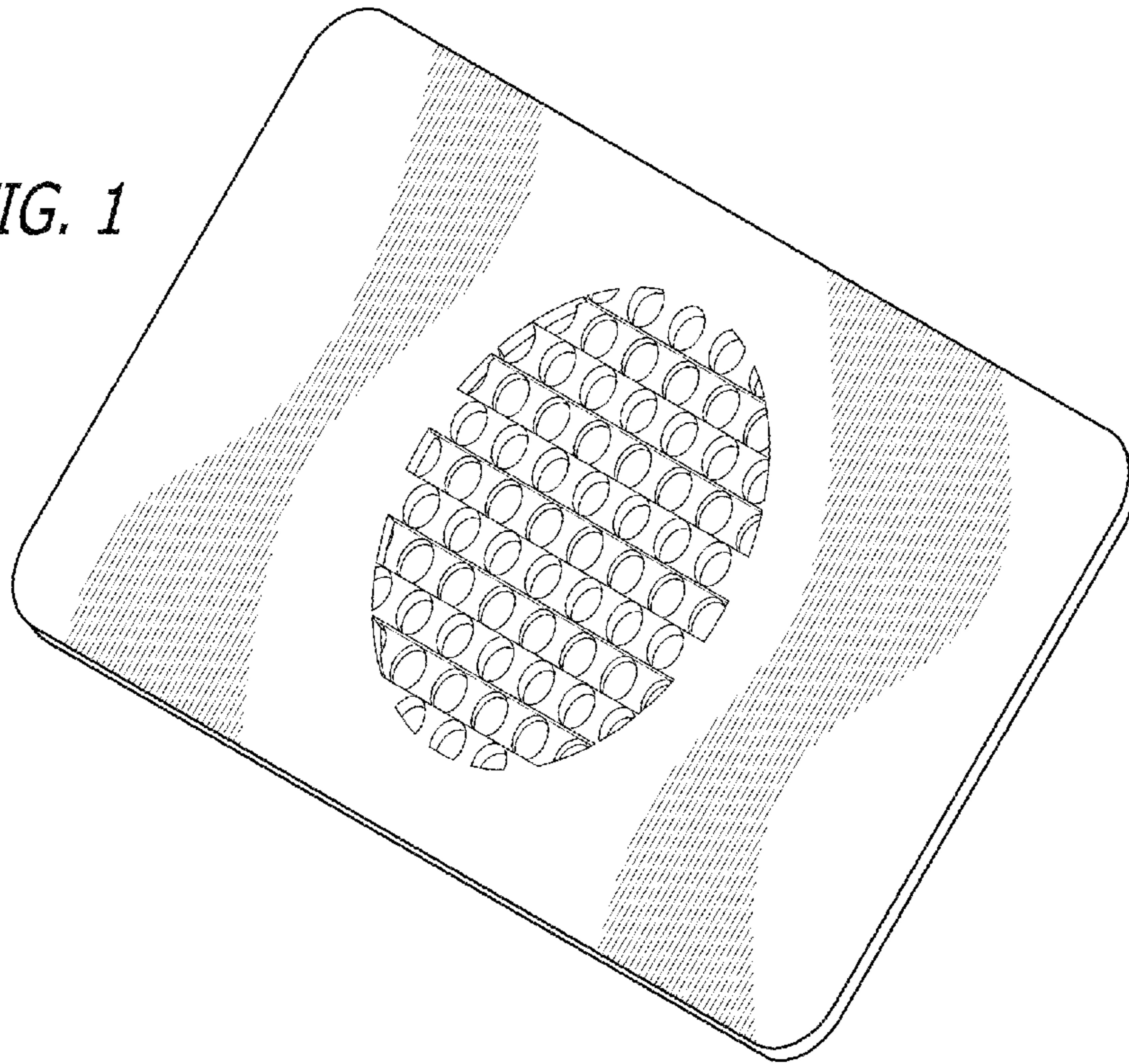

FIG. 2

FIG. 3

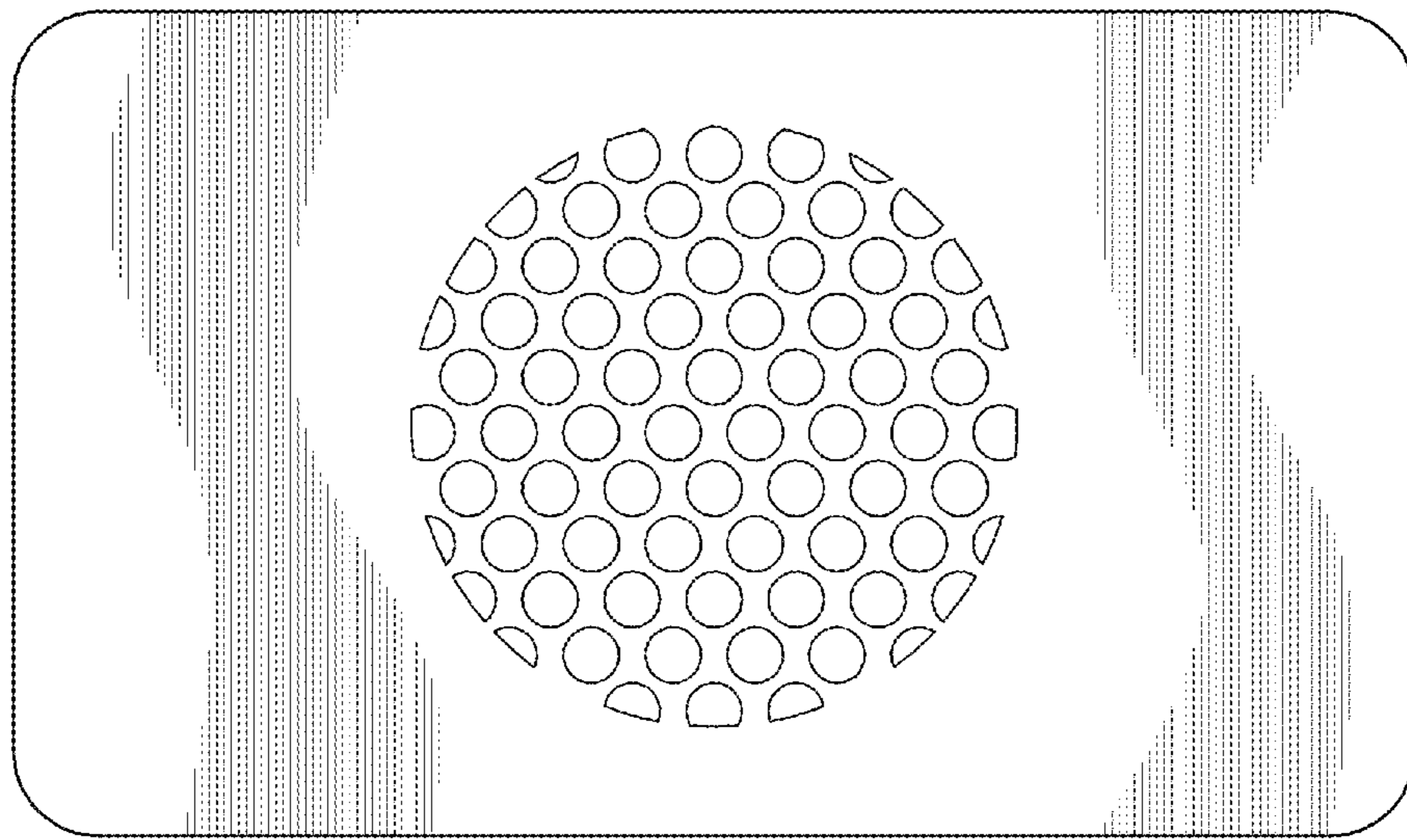

FIG. 4

FIG. 5

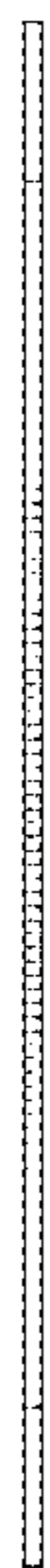
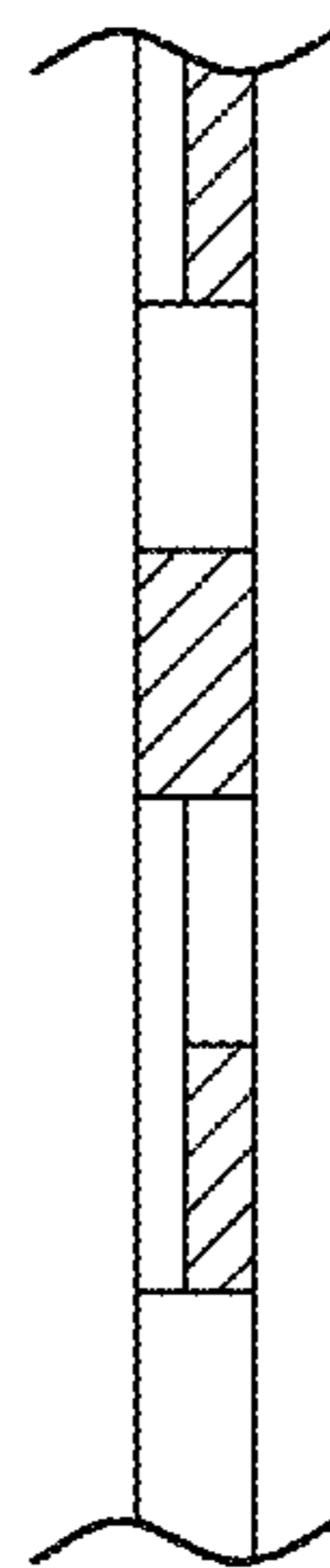

FIG. 6



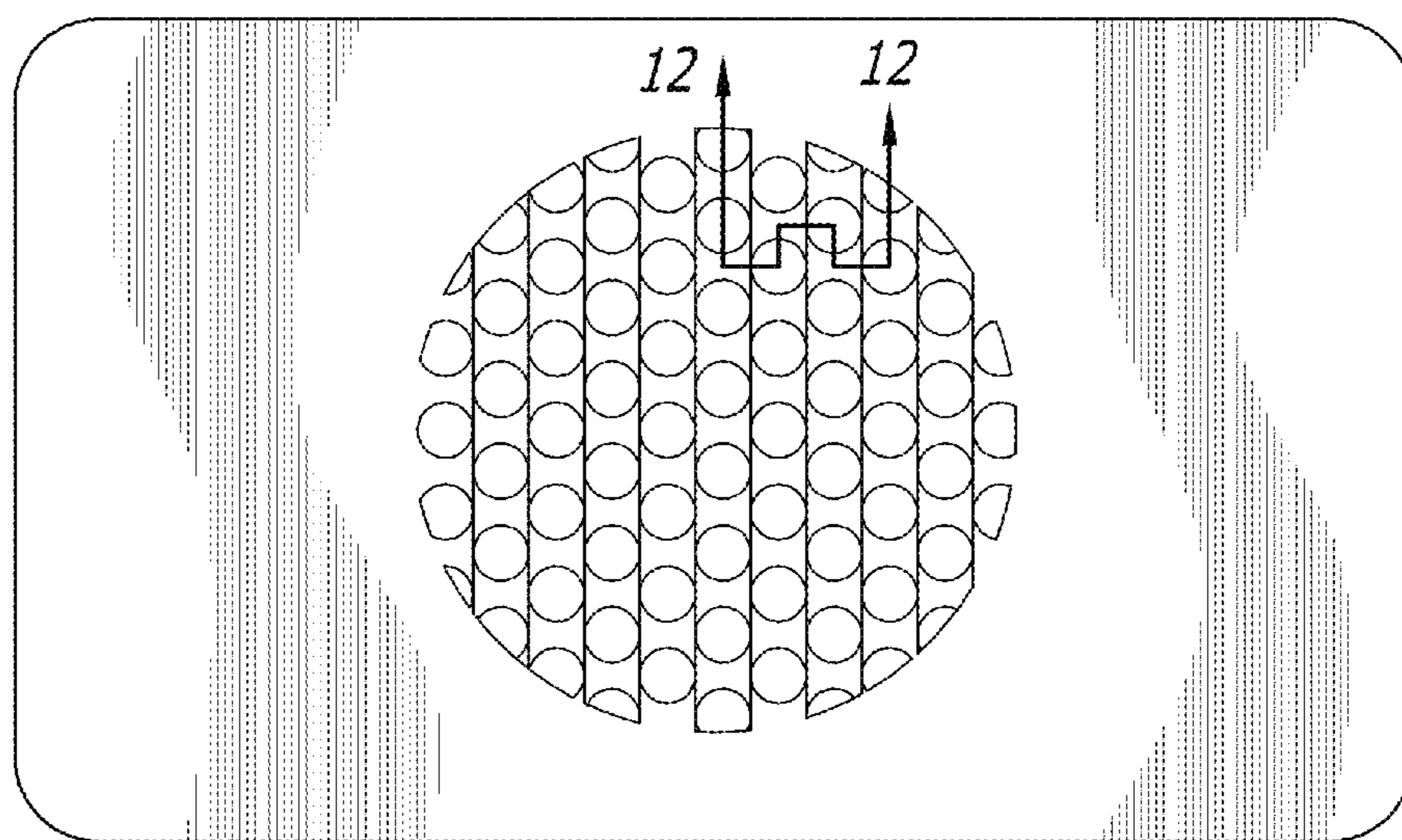
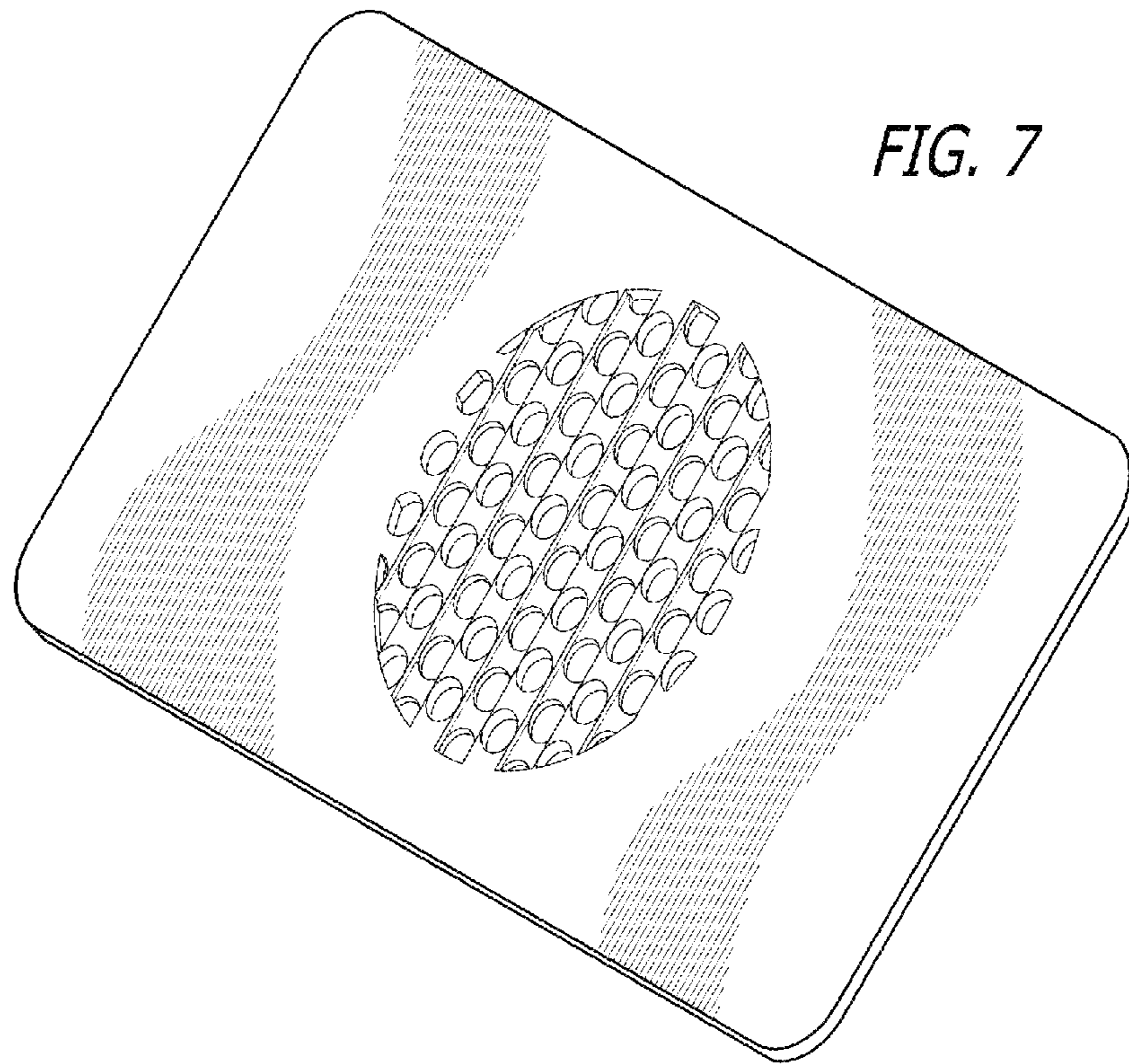

FIG. 8

FIG. 9

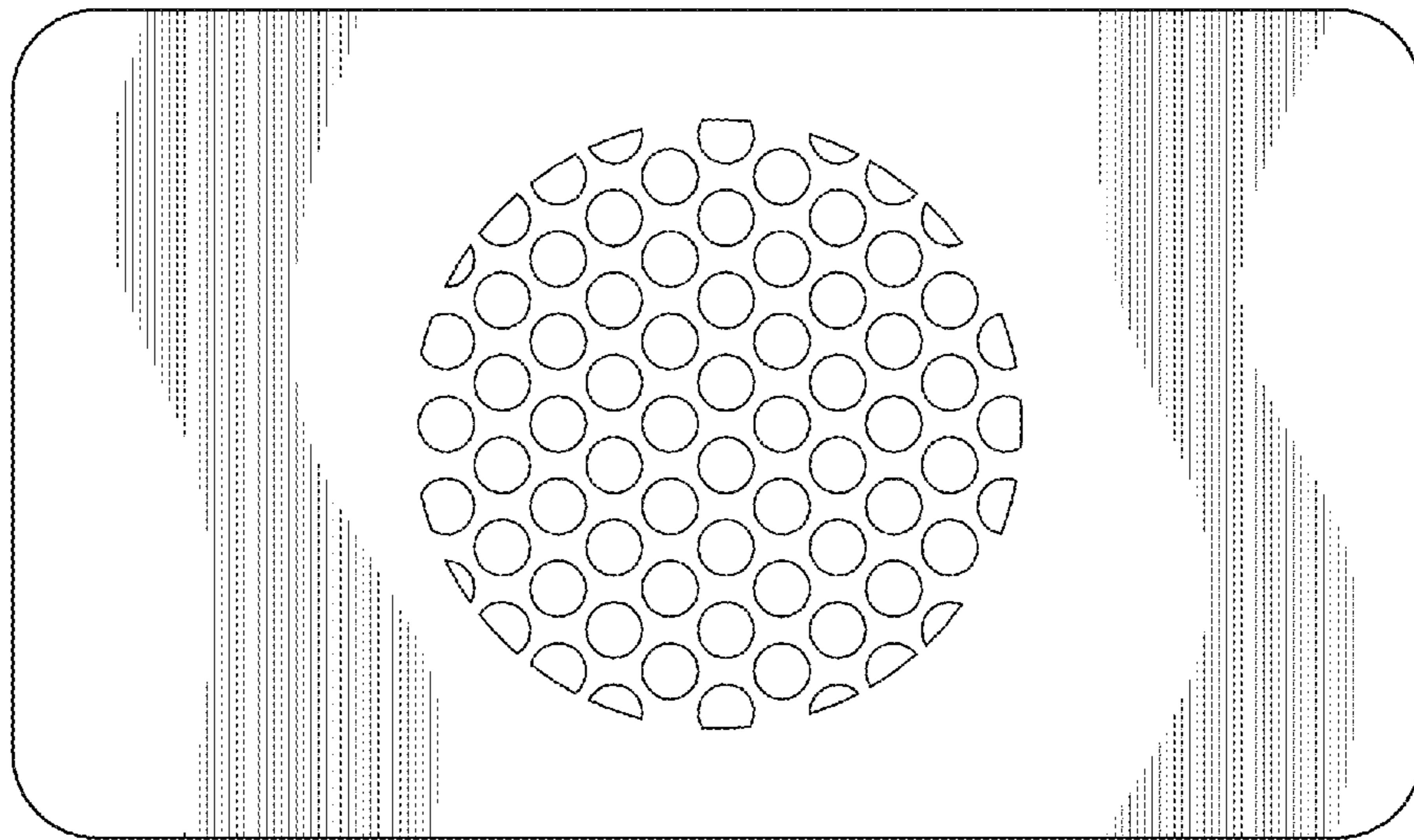

FIG. 10

FIG. 11

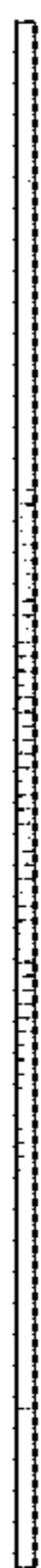
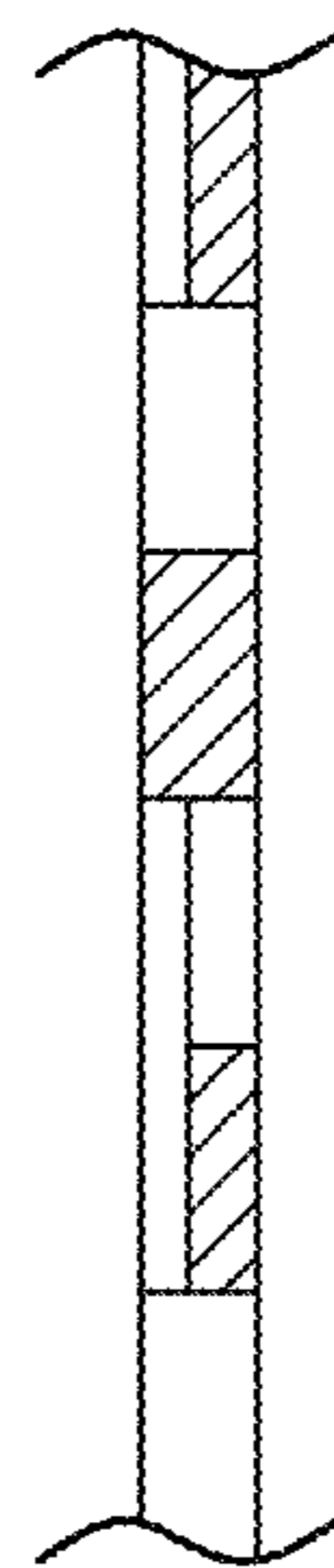

FIG. 12



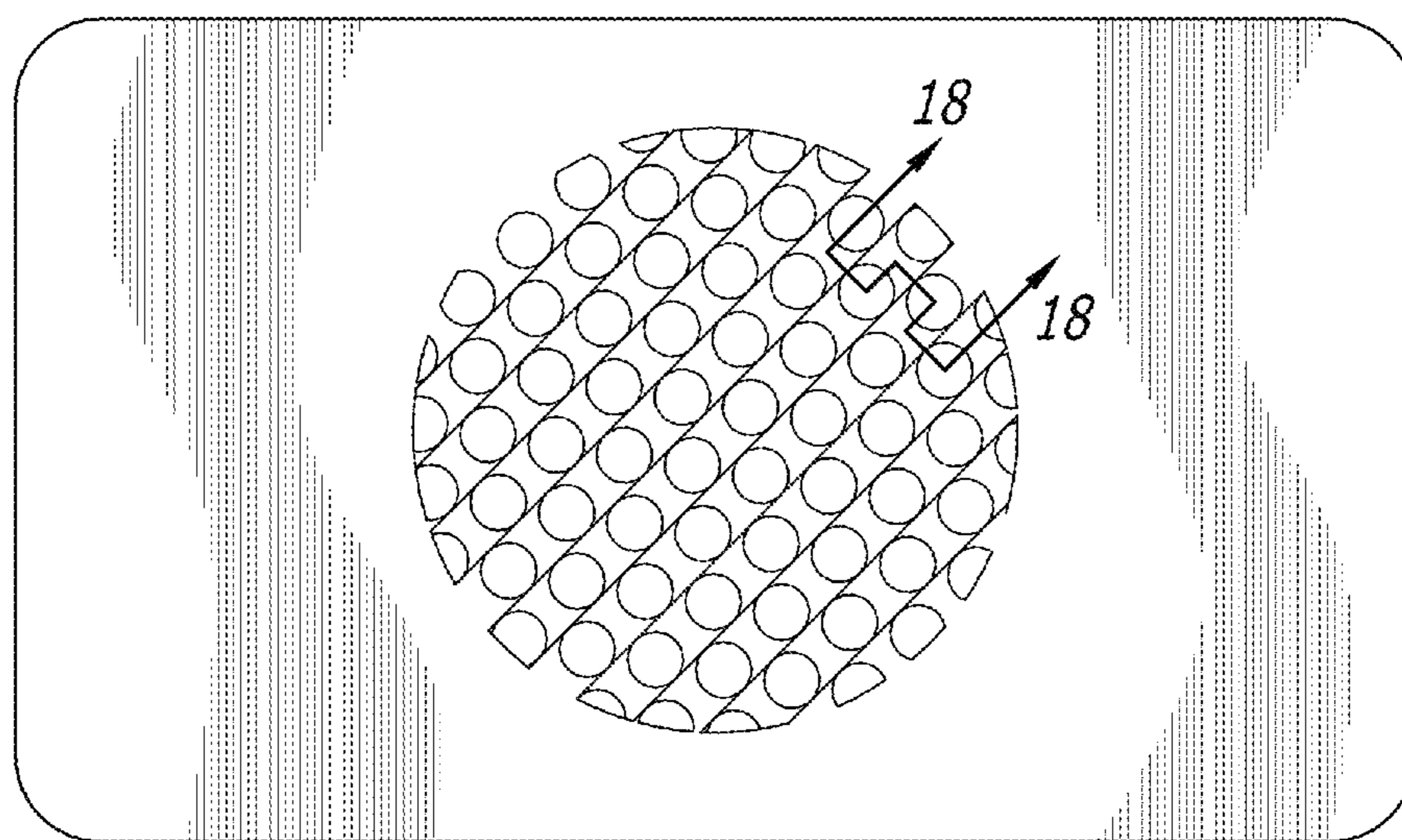
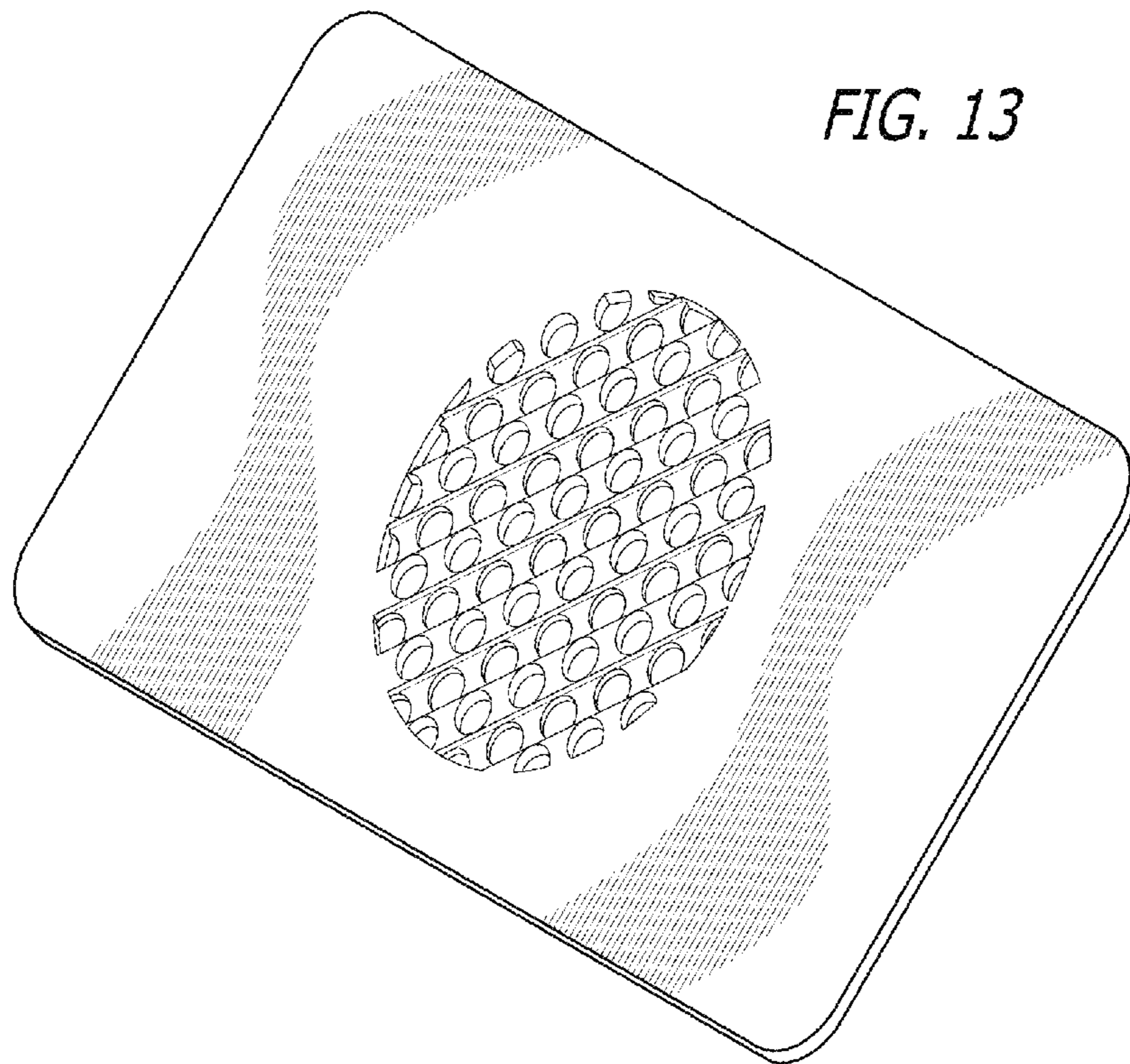

FIG. 15

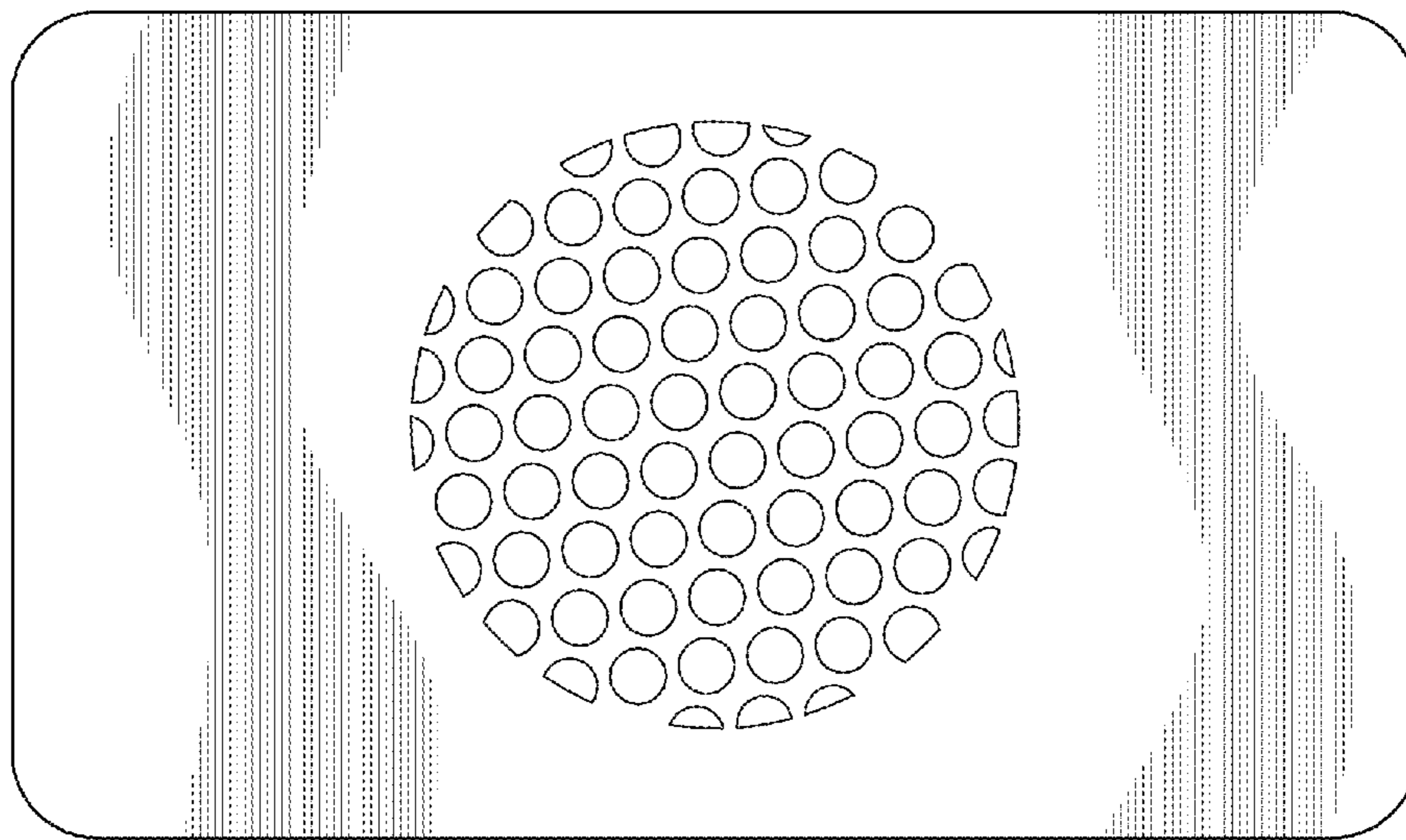

FIG. 16

FIG. 17

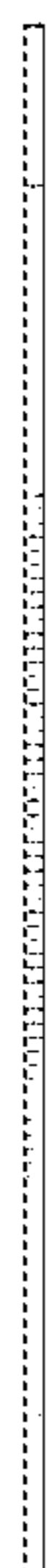

FIG. 18

