



US00D669742S

(12) **United States Design Patent**  
**Cohen**

(10) **Patent No.:** **US D669,742 S**  
(45) **Date of Patent:** **\*\* \*Oct. 30, 2012**

(54) **DIVIDED LUNCH BOX SET**

*Primary Examiner* — Terry Wallace

(76) Inventor: **Amos Cohen**, Even Yehuda (IL)

(\*) Notice: This patent is subject to a terminal disclaimer.

(57) **CLAIM**  
The ornamental design for a divided lunch box set, as shown and described.

(\*\*) Term: **14 Years**

(21) Appl. No.: **29/401,937**

(22) Filed: **Sep. 18, 2011**

(51) **LOC (9) Cl.** ..... **07-07**

(52) **U.S. Cl.** ..... **D7/629**

(58) **Field of Classification Search** ..... D7/601,  
D7/602, 629, 538–542, 612–615; D9/424–432,  
D9/761; 220/780–806, 675, 574–575, 236,  
220/326, 4.23–4.25, 256.1; 206/815, 471,  
206/469, 459.5, 556, 216, 217, 541, 542  
See application file for complete search history.

**DESCRIPTION**

FIG. 1 is an isometric view of the divided lunch box set, presented in the assembled state;  
FIG. 2 is an isometric view of the divided lunch box set, presented in the exploded state;  
FIG. 3 is an isometric view of the container of the divided lunch box set;  
FIG. 4 is a top view of the container of the divided lunch box set;  
FIG. 5 is a side view of the container of the divided lunch box set;  
FIG. 6 is a front view of the container of the divided lunch box set;  
FIG. 7 is a bottom view of the container of the divided lunch box set;  
FIG. 8 is an isometric view of the cover of the divided lunch box set;  
FIG. 9 is a top view of the cover of the divided lunch box set;  
FIG. 10 is a side view of the cover of the divided lunch box set;  
FIG. 11 is a front view of the cover of the divided lunch box set; and,  
FIG. 12 is a bottom view of the cover of the divided lunch box set.  
The utensils are shown in broken lines for illustrative purposes only and form no part of the claimed design.

(56) **References Cited**

**U.S. PATENT DOCUMENTS**

1,458,679	A *	6/1923	Bishop	.....	126/261
1,514,379	A *	11/1924	Fleischer	.....	206/229
2,584,379	A *	2/1952	Chmielewski	.....	206/551
3,679,093	A *	7/1972	Chang	.....	220/574
4,930,637	A *	6/1990	DeRoseau	.....	206/541
D311,302	S *	10/1990	Pozzi	.....	D7/629
5,042,712	A *	8/1991	DeRoseau	.....	229/401
5,251,758	A *	10/1993	Kolacek	.....	206/542
6,112,899	A *	9/2000	Zeringue	.....	206/541
6,412,653	B1 *	7/2002	Waterhouse	.....	220/556
D472,774	S *	4/2003	Pelstring et al.	.....	D7/629
D489,579	S *	5/2004	Wright	.....	D7/629
6,840,395	B2 *	1/2005	Agarwal et al.	.....	220/556
D530,160	S *	10/2006	Maltese et al.	.....	D7/629
D646,587	S *	10/2011	Daniels	.....	D9/761

\* cited by examiner

**1 Claim, 12 Drawing Sheets**

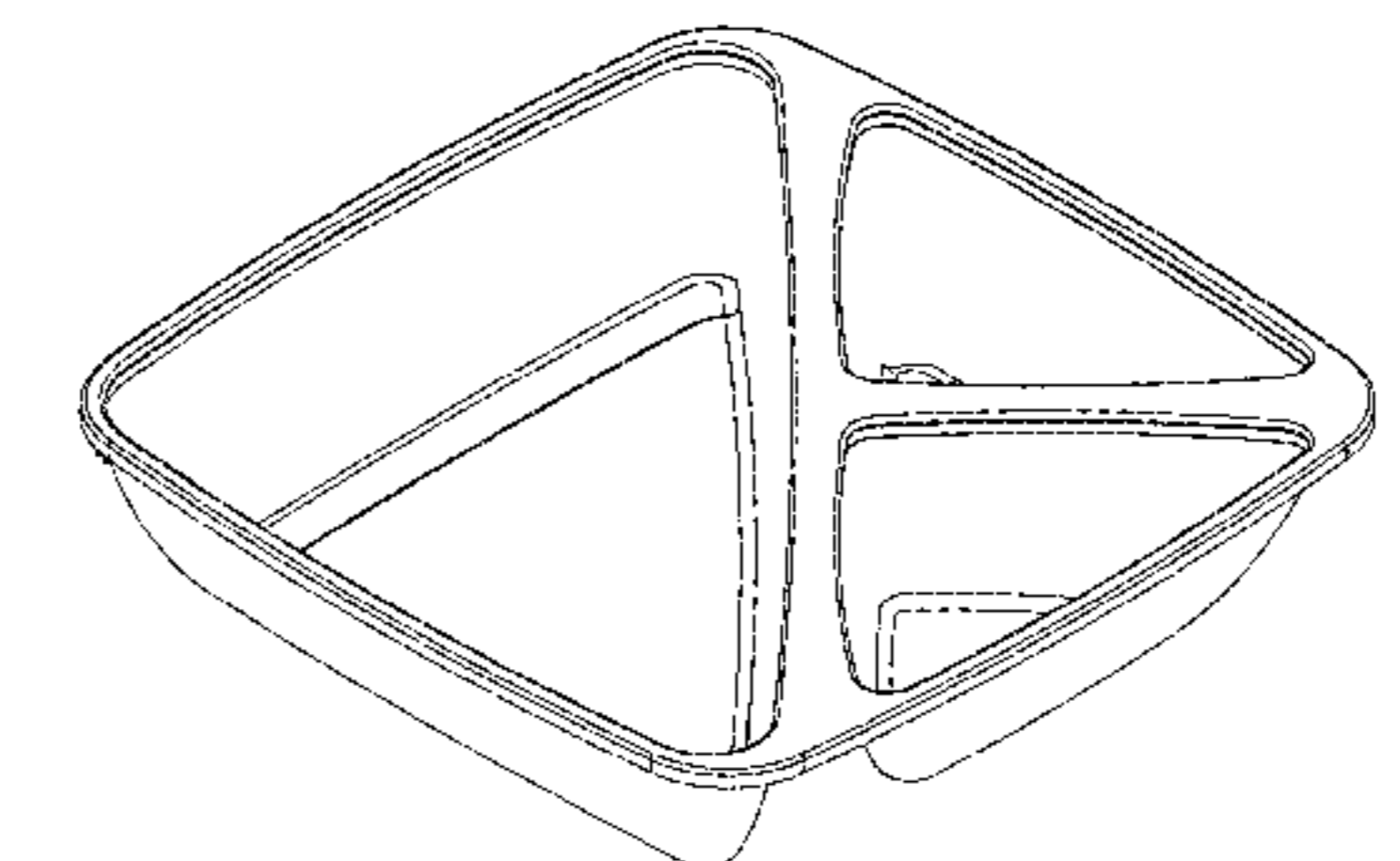
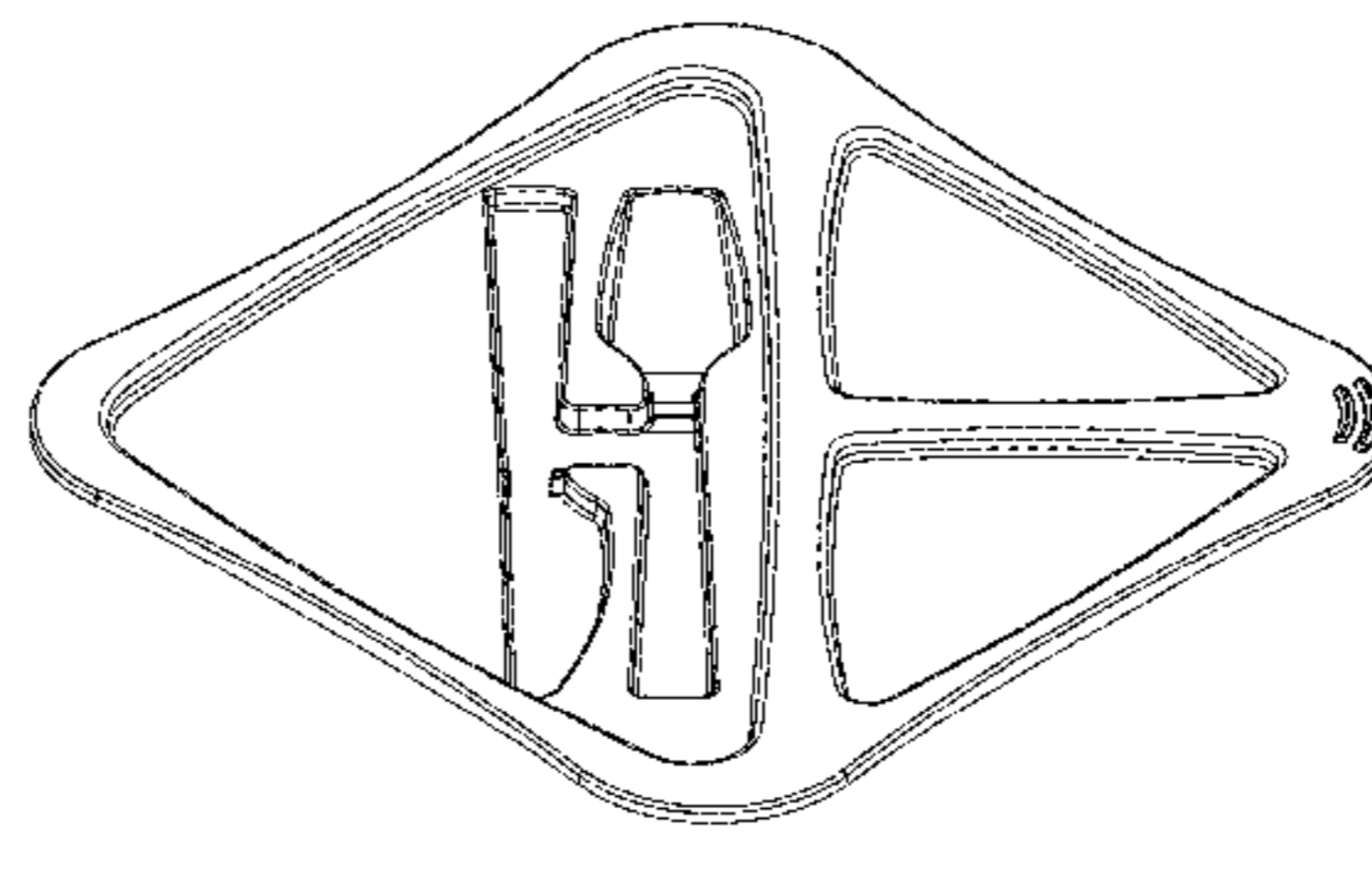
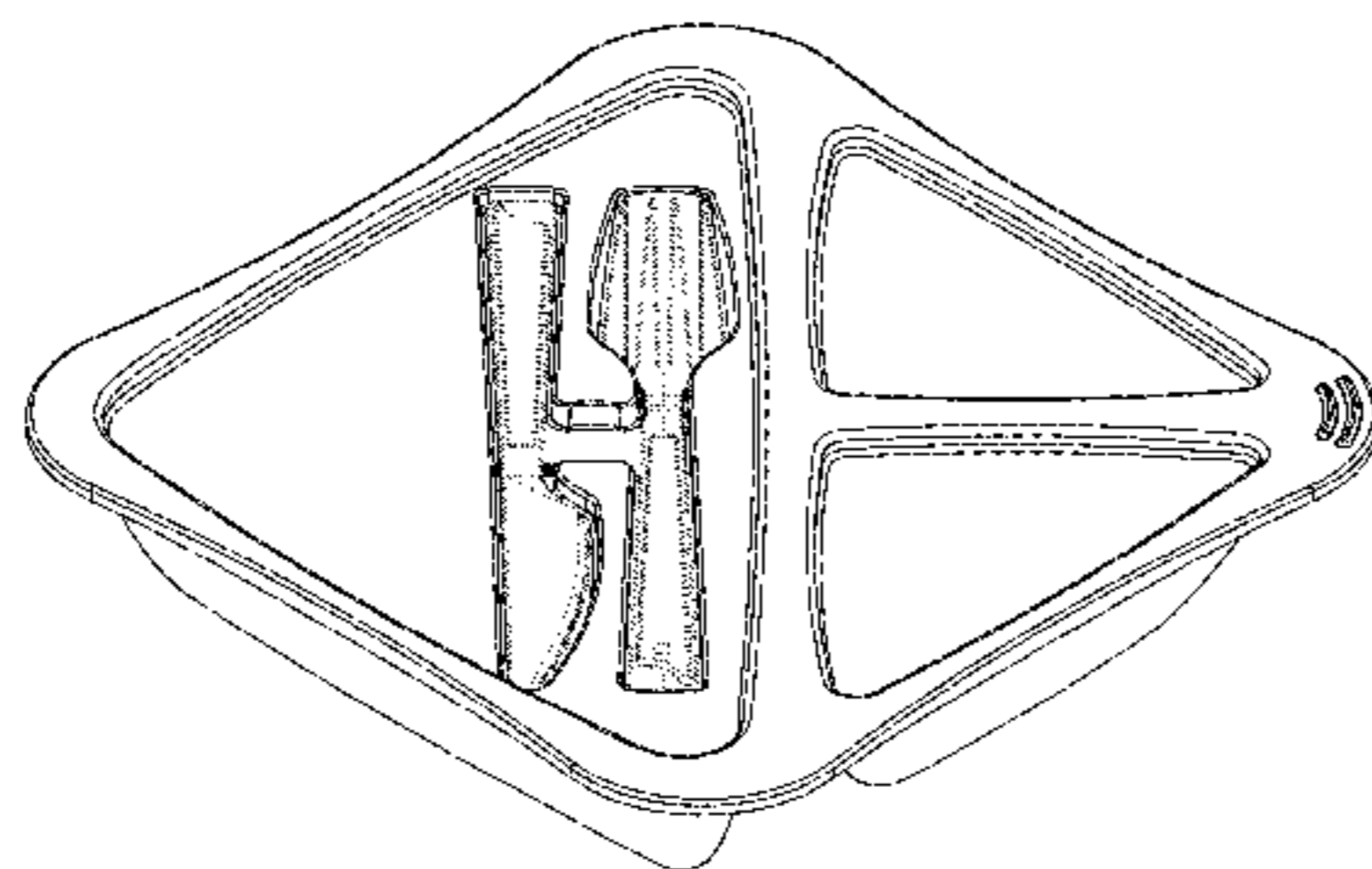

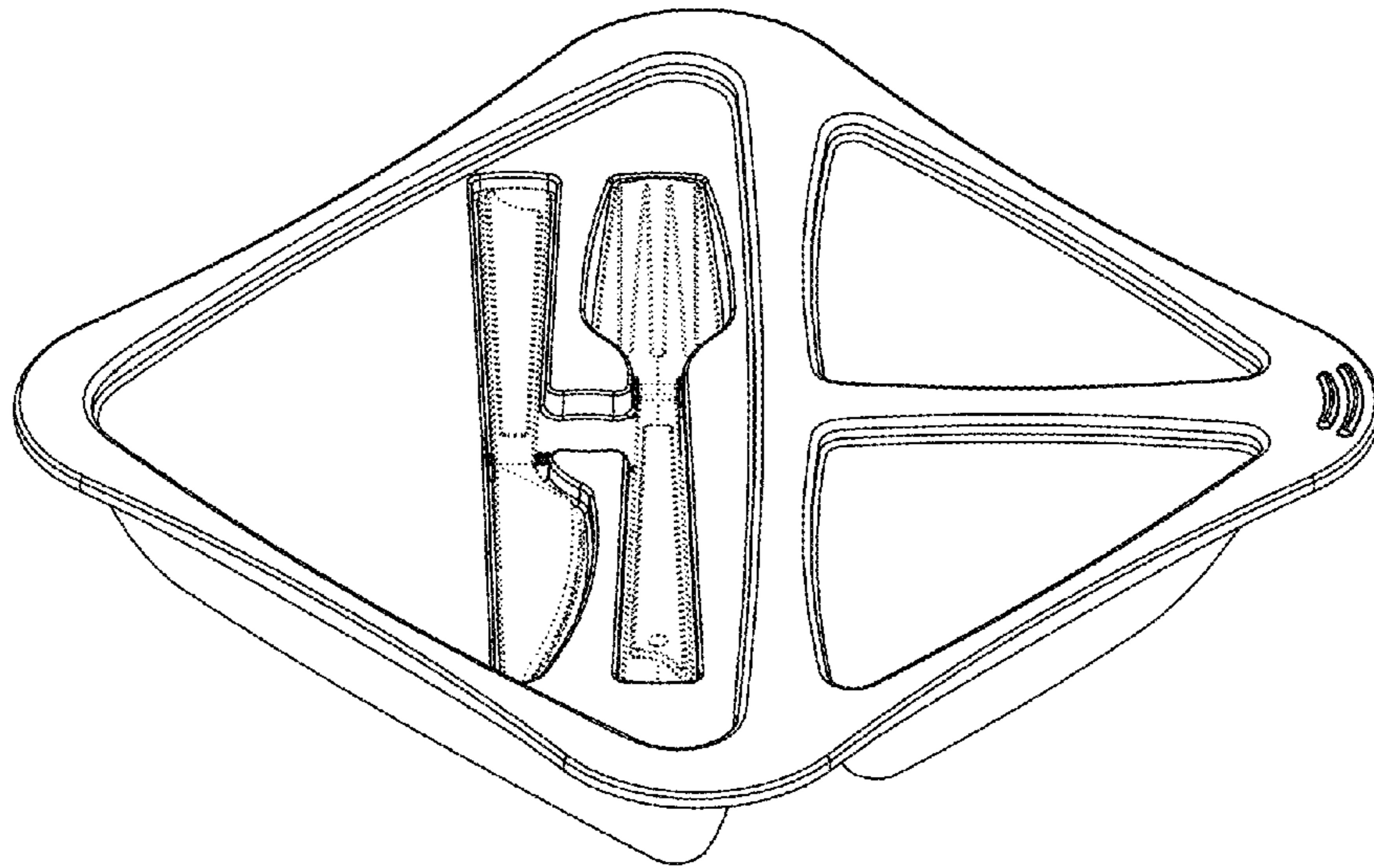

Fig. 1

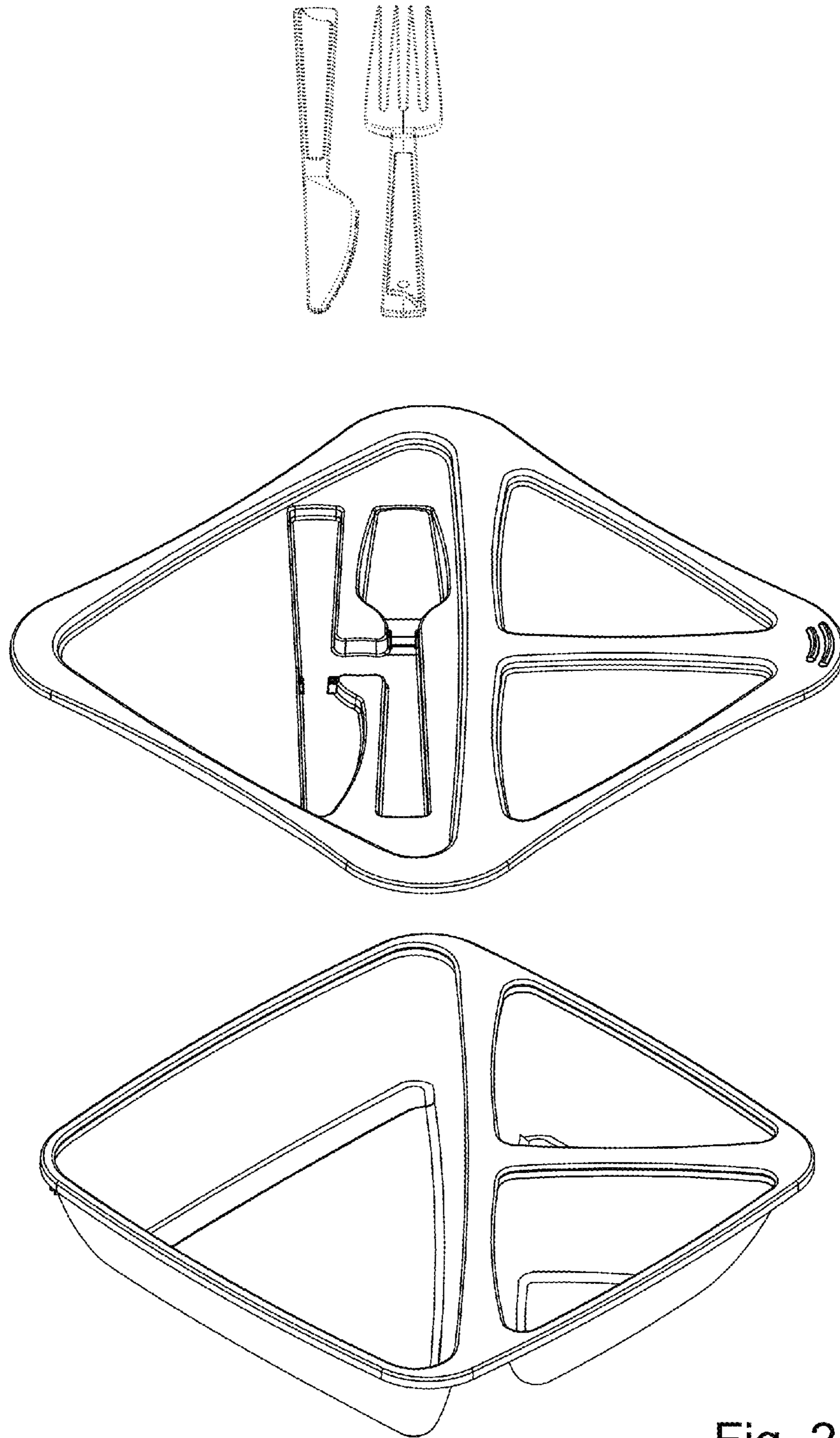

Fig. 2

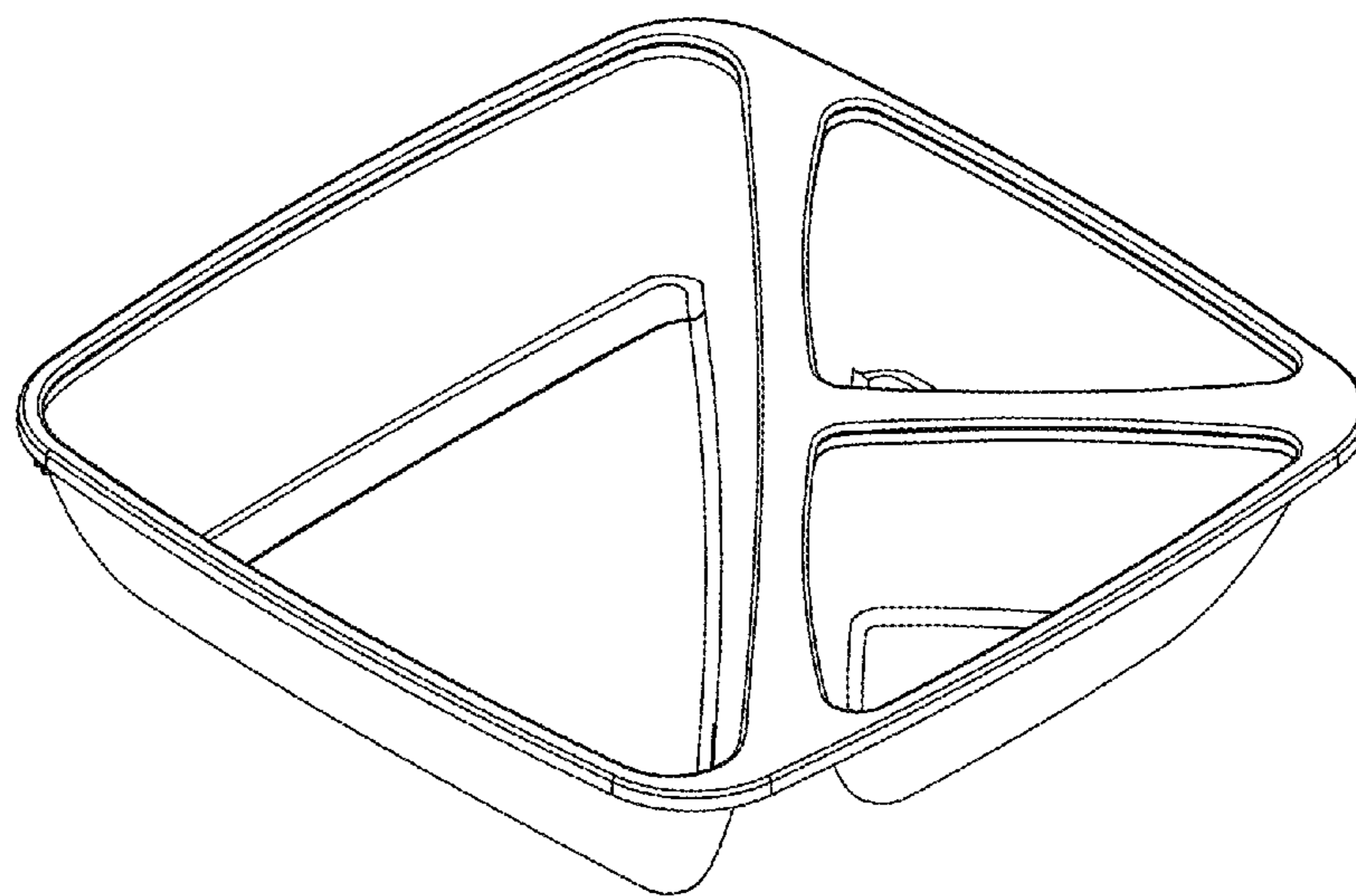

Fig. 3

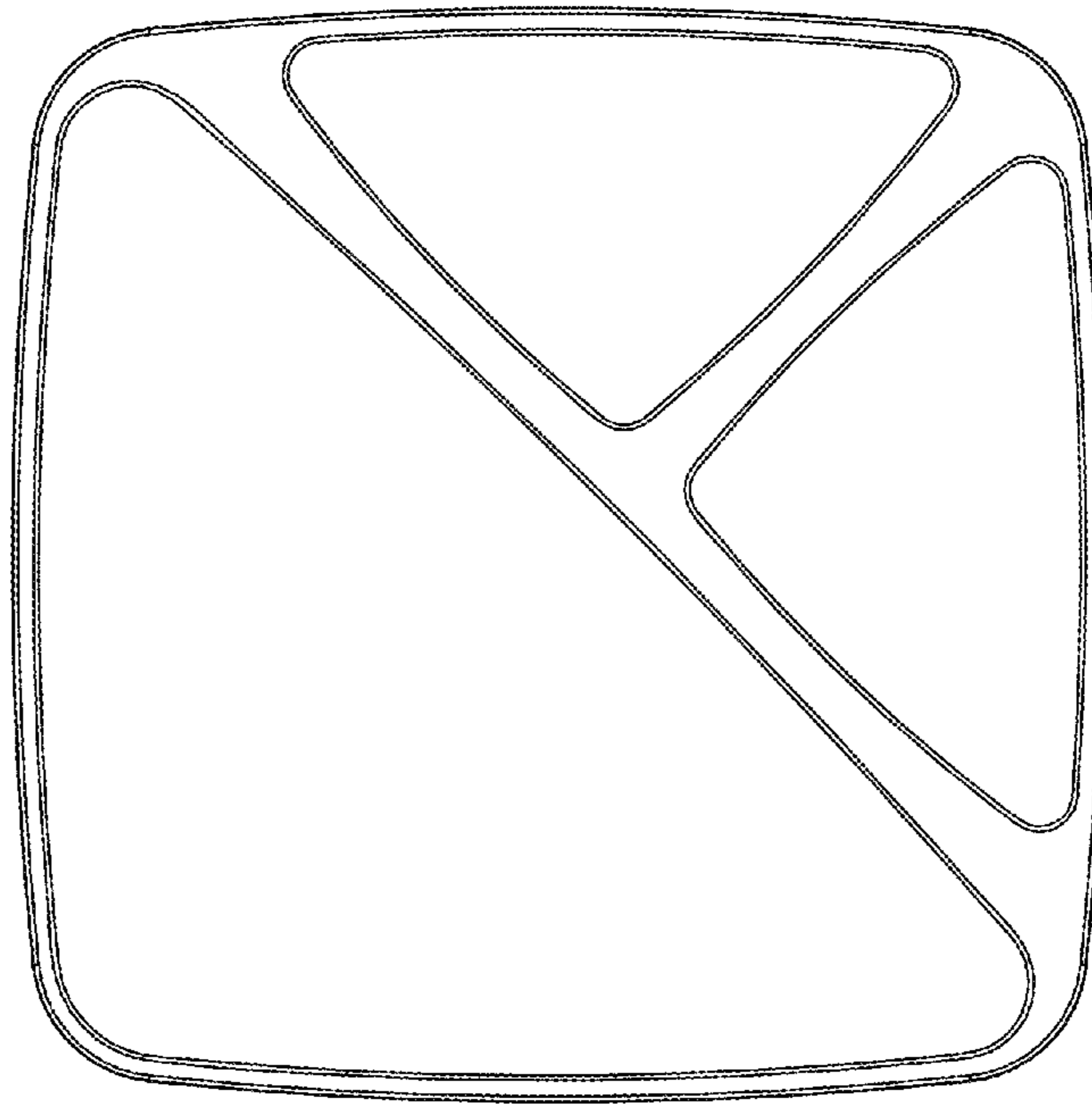

Fig. 4



Fig. 5

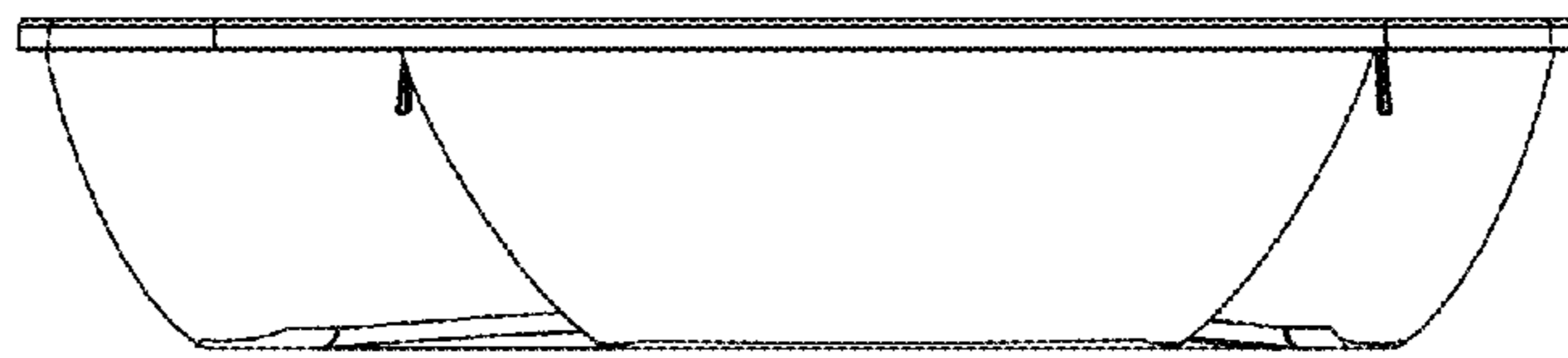

Fig. 6

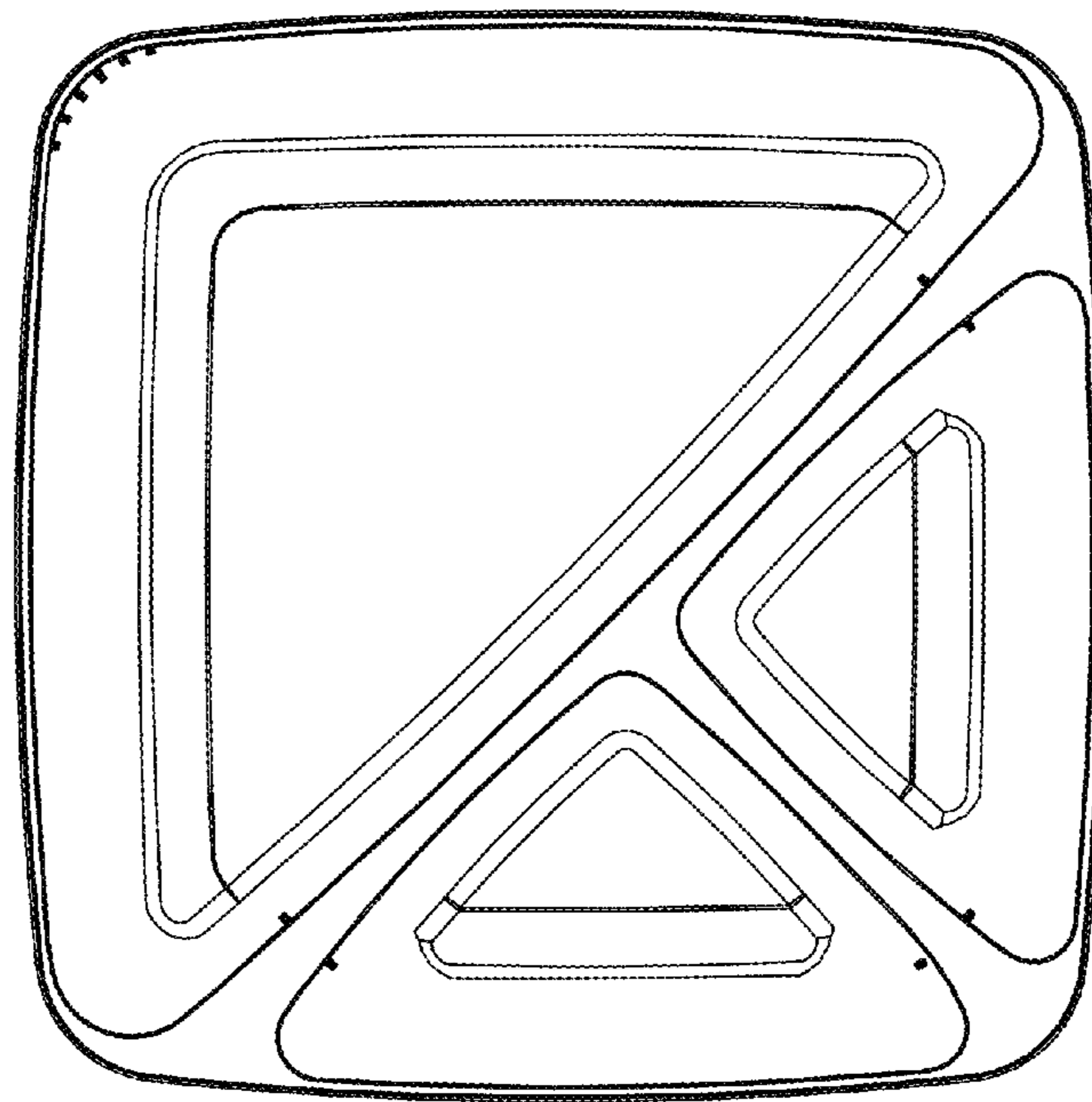

Fig. 7



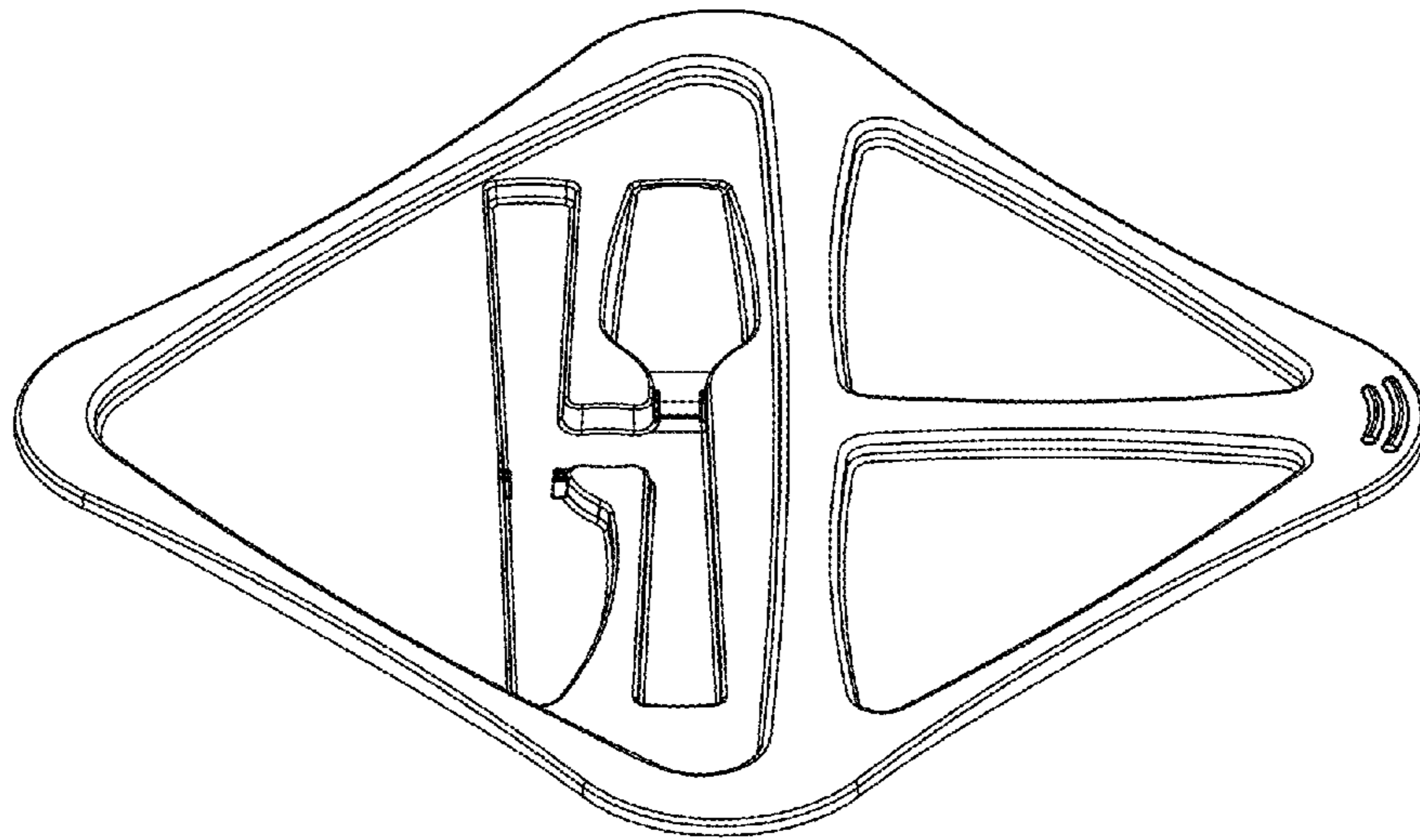

Fig. 8

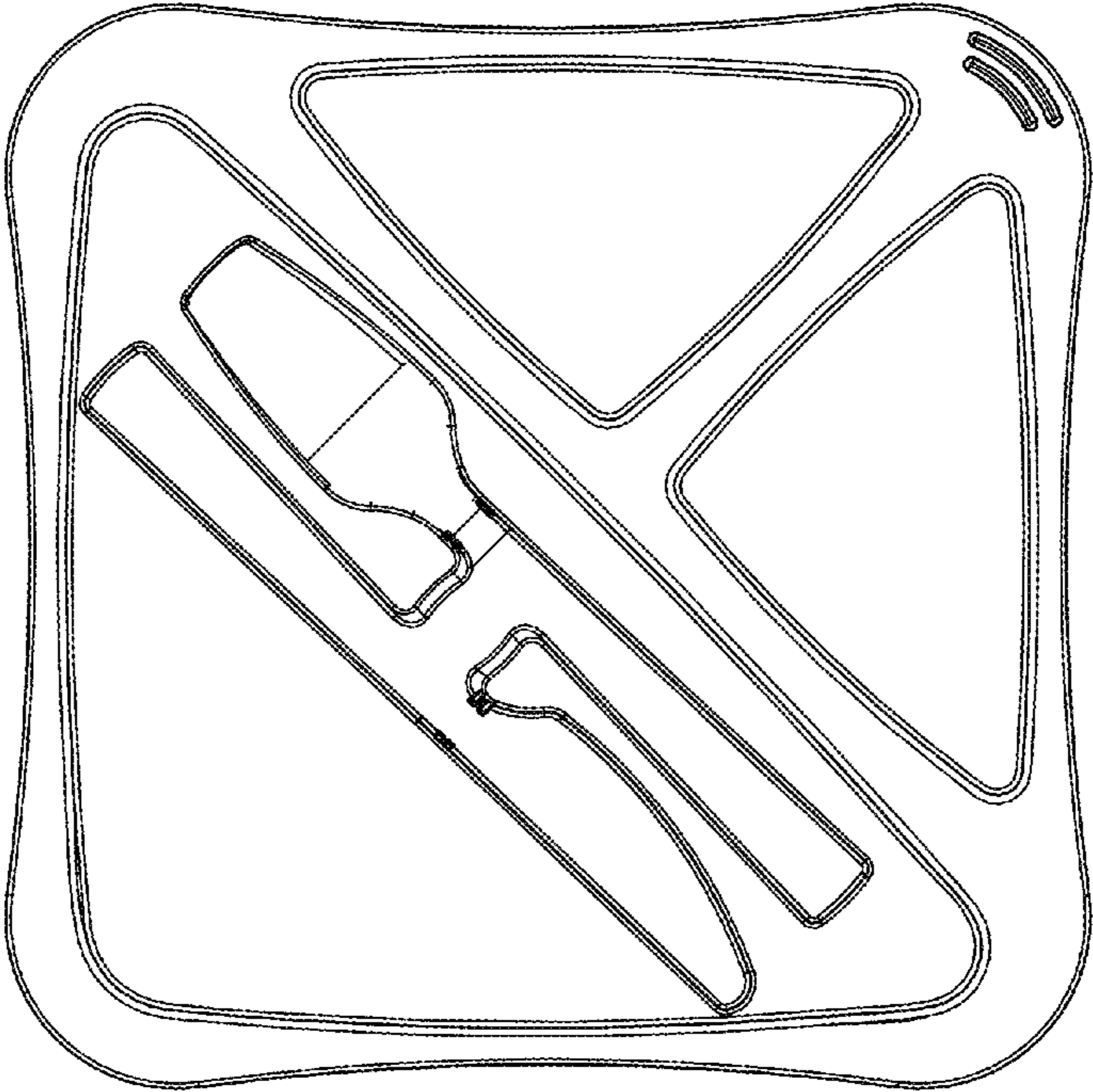

Fig. 9

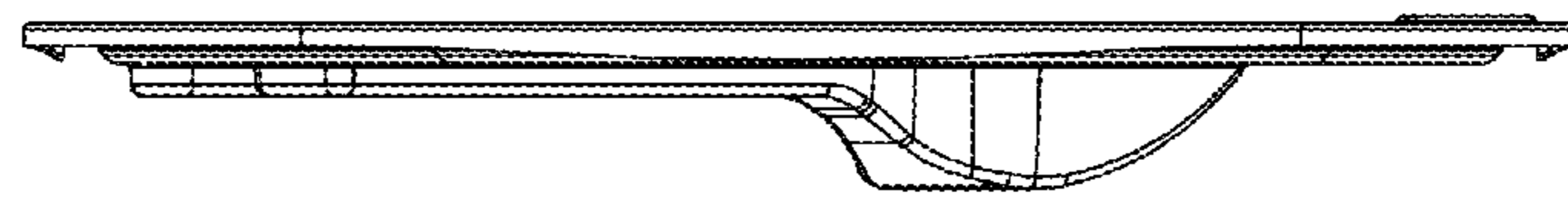

Fig. 10

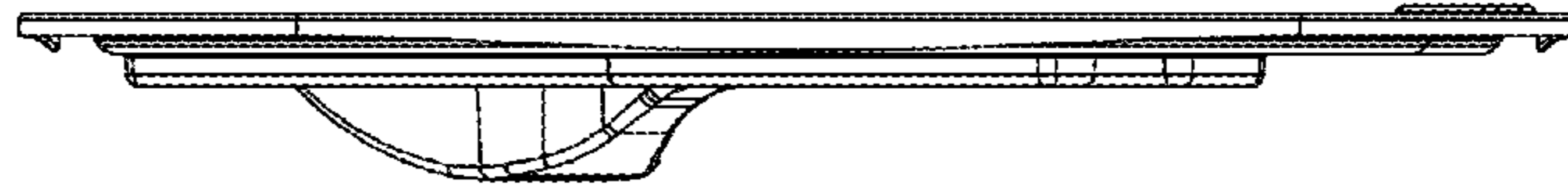

Fig. 11

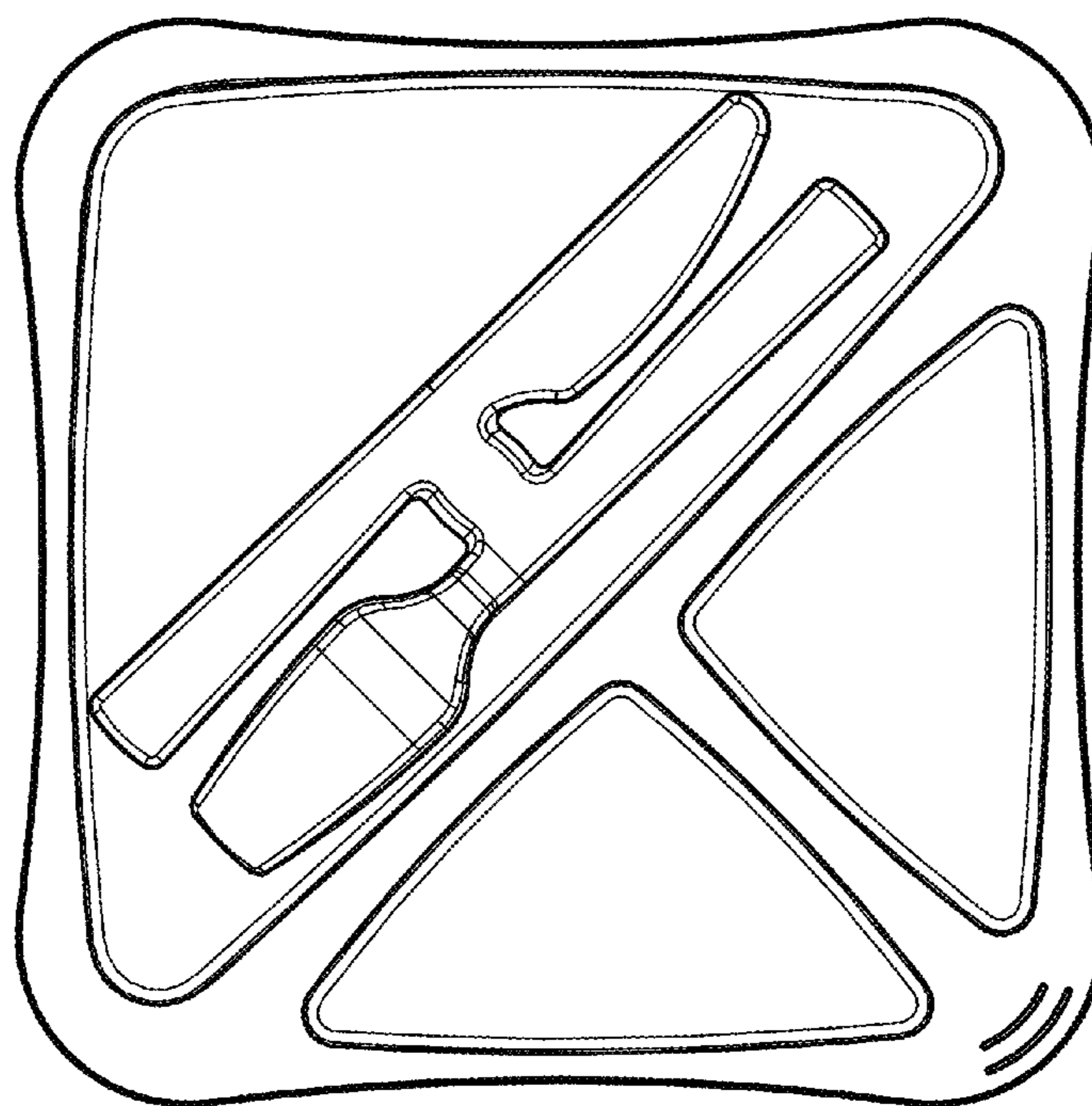

Fig. 12