



US00D669738S

(12) **United States Design Patent**
Chen

(10) **Patent No.:** **US D669,738 S**

(45) **Date of Patent:** **** Oct. 30, 2012**

(54) **BOWL**

(76) Inventor: **Chin Chuan Chen**, Taichung (TW)

(**) Term: **14 Years**

(21) Appl. No.: **29/417,951**

(22) Filed: **Apr. 11, 2012**

(51) **LOC (9) Cl.** **07-01**

(52) **U.S. Cl.** **D7/543**

(58) **Field of Classification Search** D7/542,
D7/500, 538, 601, 602, 543, 545, 553.6, 552.2;
D9/424, 429; 220/573.1, 574, 206
See application file for complete search history.

(56) **References Cited**

U.S. PATENT DOCUMENTS

D233,202 S	*	10/1974	Chernak	D7/545
D386,042 S	*	11/1997	Miller	D7/396.1
D456,673 S	*	5/2002	Kerman	D7/545
D483,218 S	*	12/2003	Fino et al.	D7/360
D483,617 S	*	12/2003	Watson	D7/545
D483,618 S	*	12/2003	Watson	D7/545
D607,280 S	*	1/2010	Kellermann et al.	D7/548

D607,689 S	*	1/2010	Hart et al.	D7/360
D631,296 S	*	1/2011	Green-Cotton et al.	D7/545
D635,402 S	*	4/2011	Shah	D7/538
D645,307 S	*	9/2011	Shamoon	D7/545
D653,911 S	*	2/2012	Stamper et al.	D7/543
D657,617 S	*	4/2012	Sarnoff et al.	D7/360

* cited by examiner

Primary Examiner — Cynthia Underwood

(57) **CLAIM**

The ornamental design for a bowl, as shown and described.

DESCRIPTION

FIG. 1 is a perspective view of a bowl showing my new design;

FIG. 2 is a front end view thereof;

FIG. 3 is a rear end view thereof;

FIG. 4 is a left side view thereof;

FIG. 5 is a right side view thereof;

FIG. 6 is a top plan view thereof; and,

FIG. 7 is a bottom plan view thereof.

The broken lines represent portions of the structure which form no part of the claim.

1 Claim, 4 Drawing Sheets

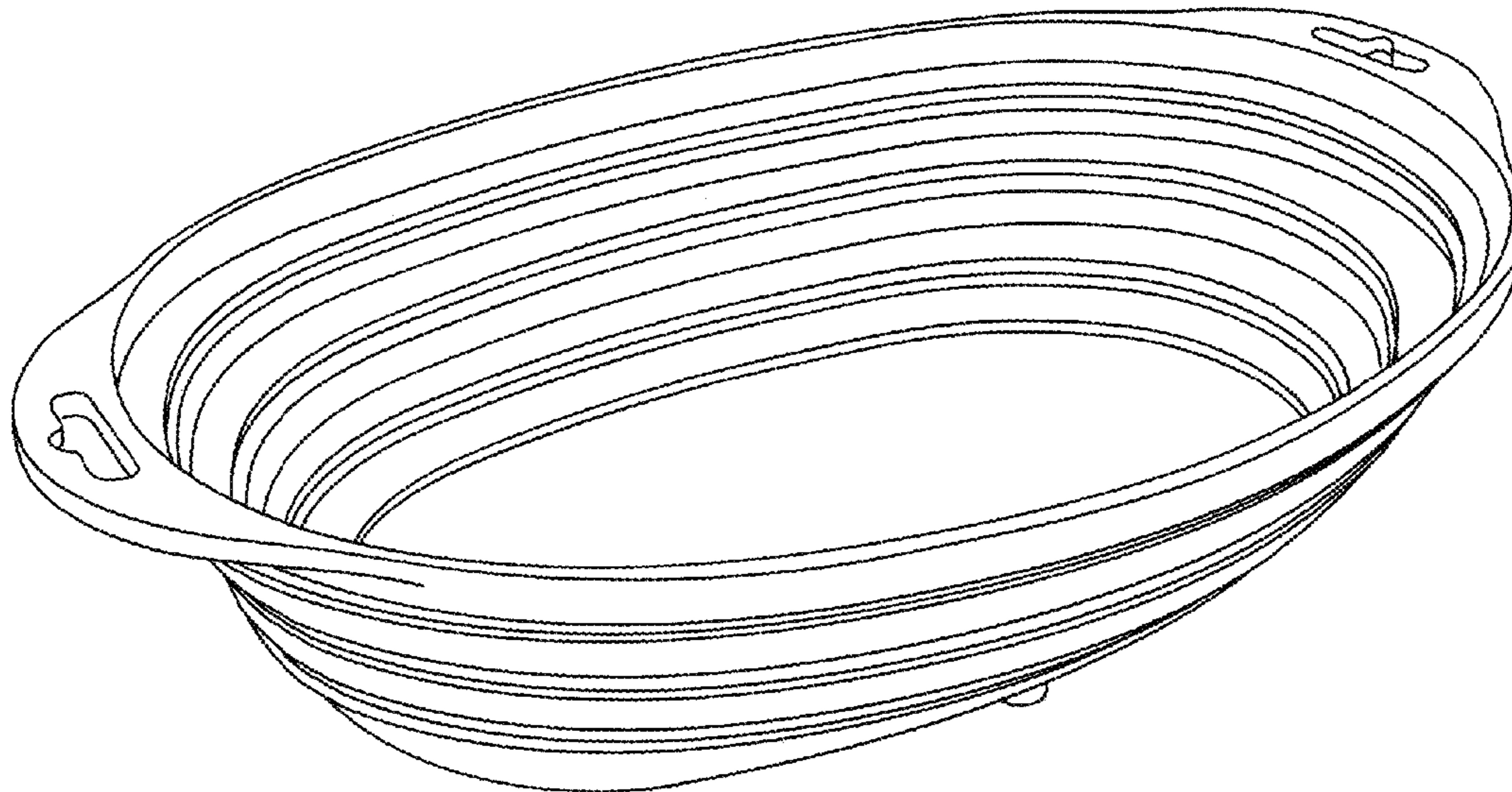

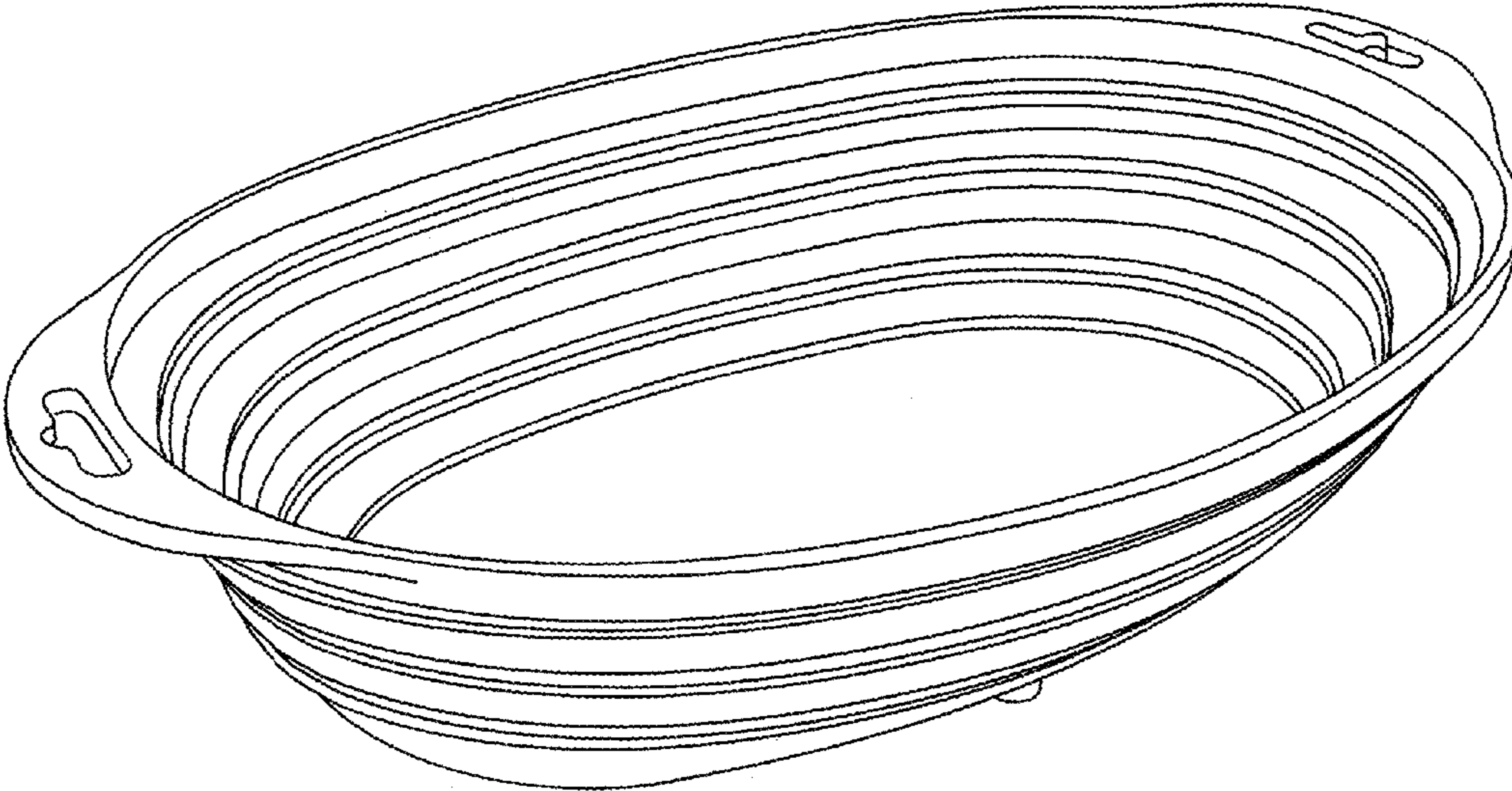

FIG. 1

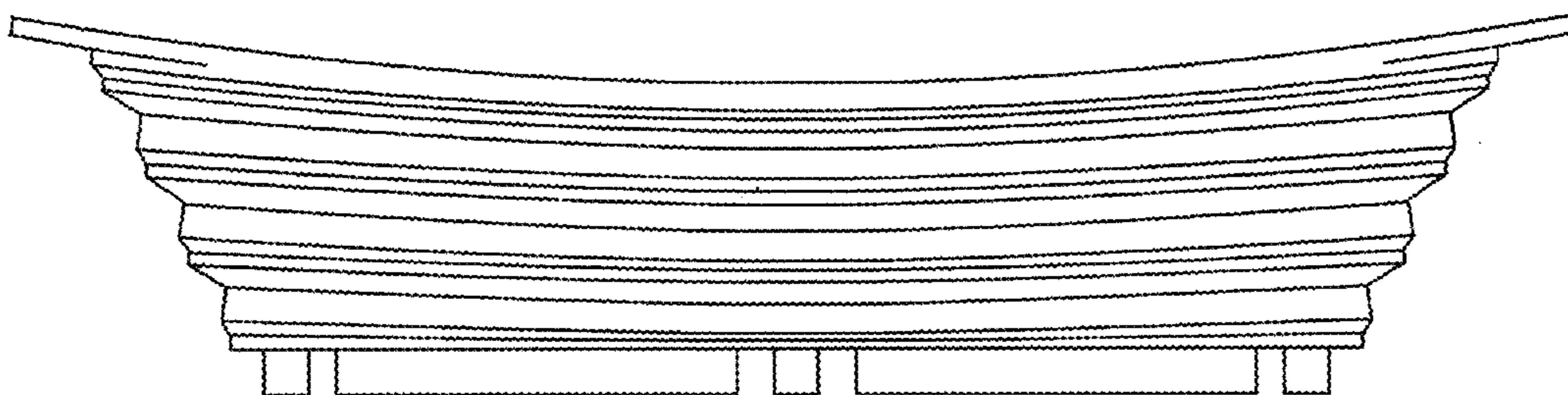

FIG. 2

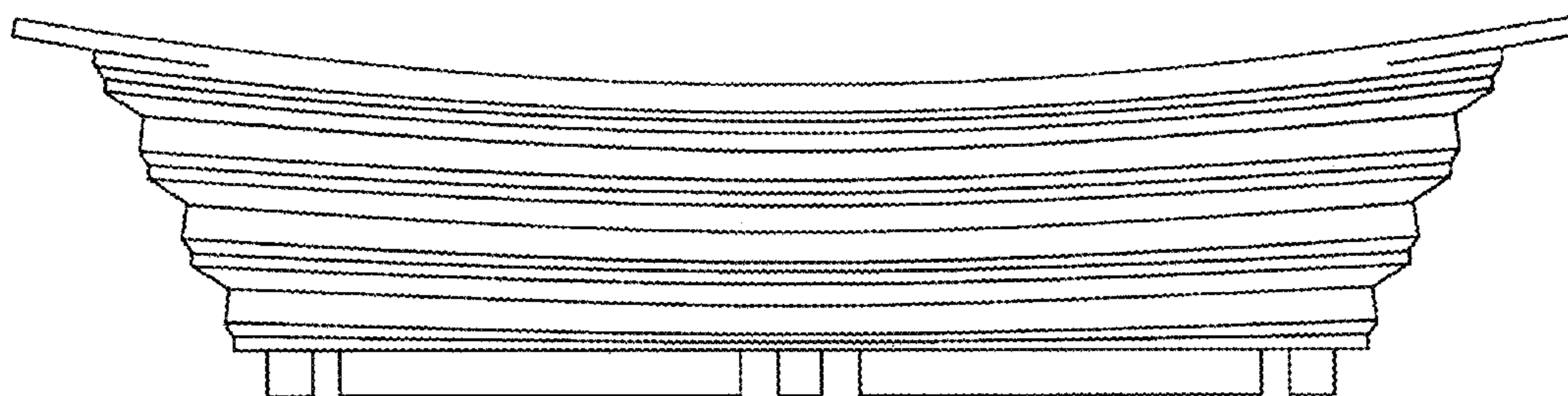

FIG. 3

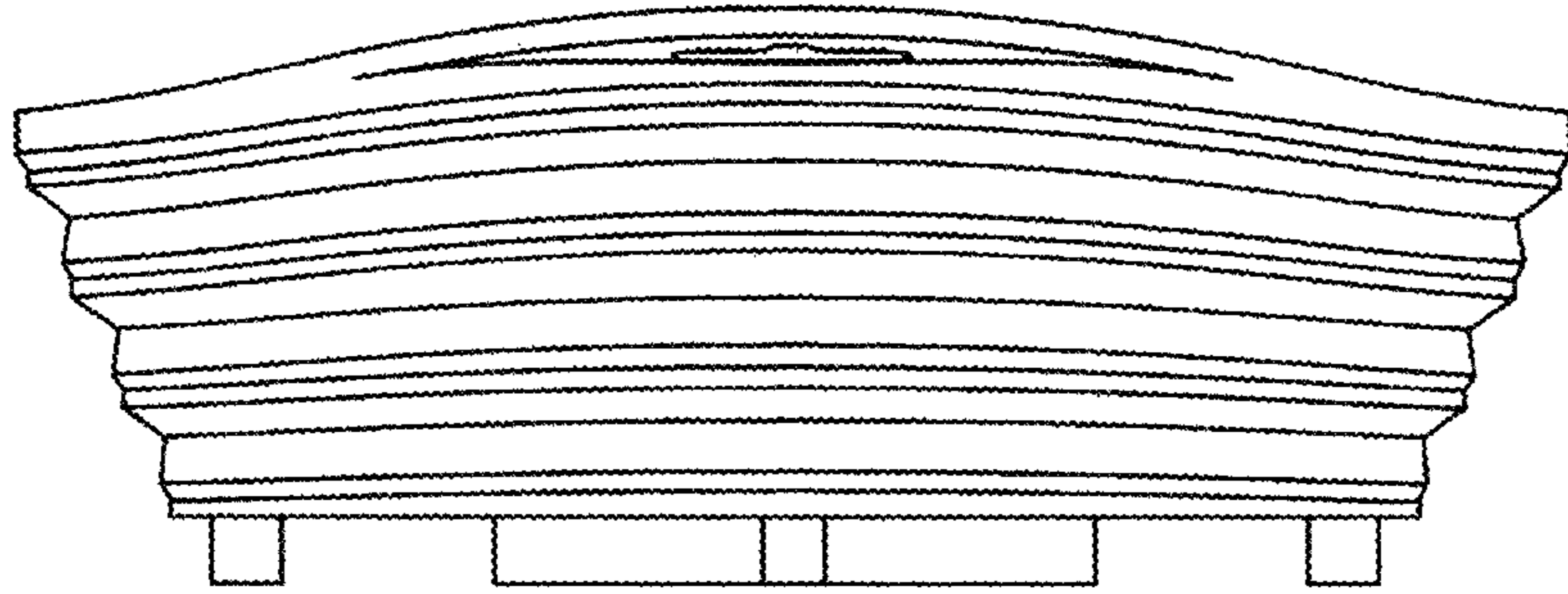

FIG. 4

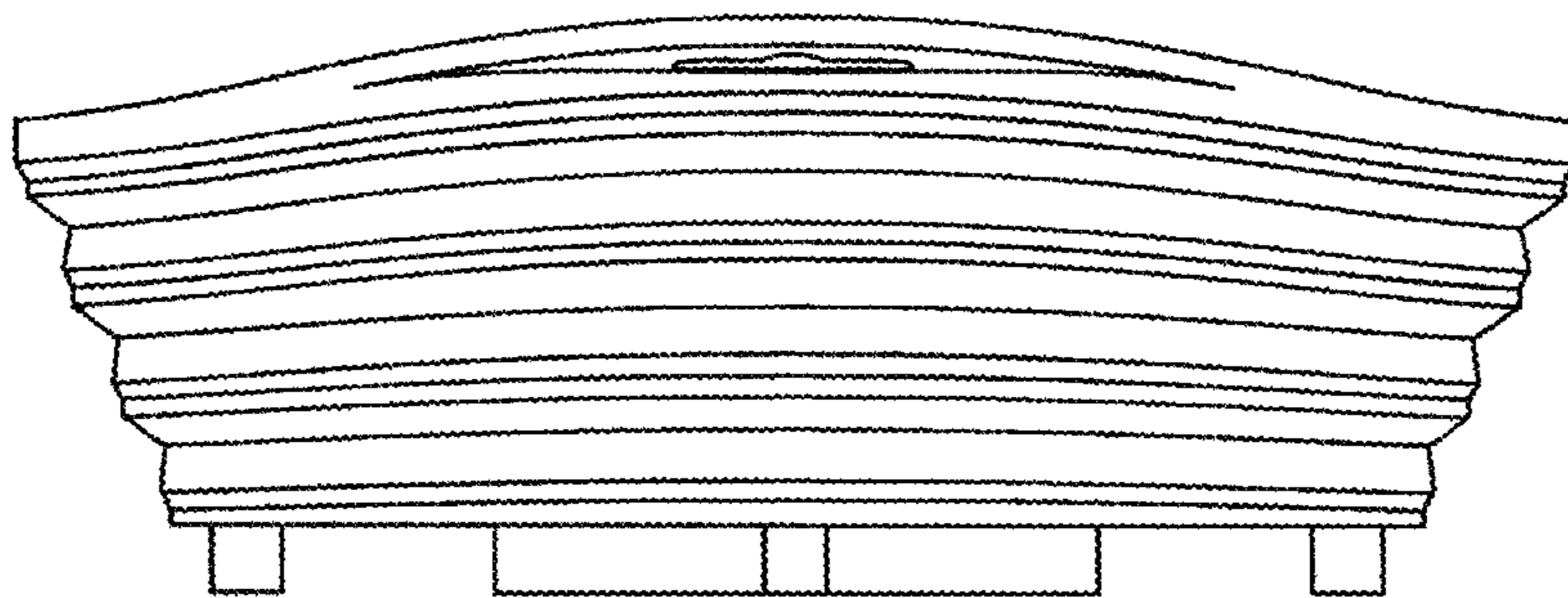

FIG. 5

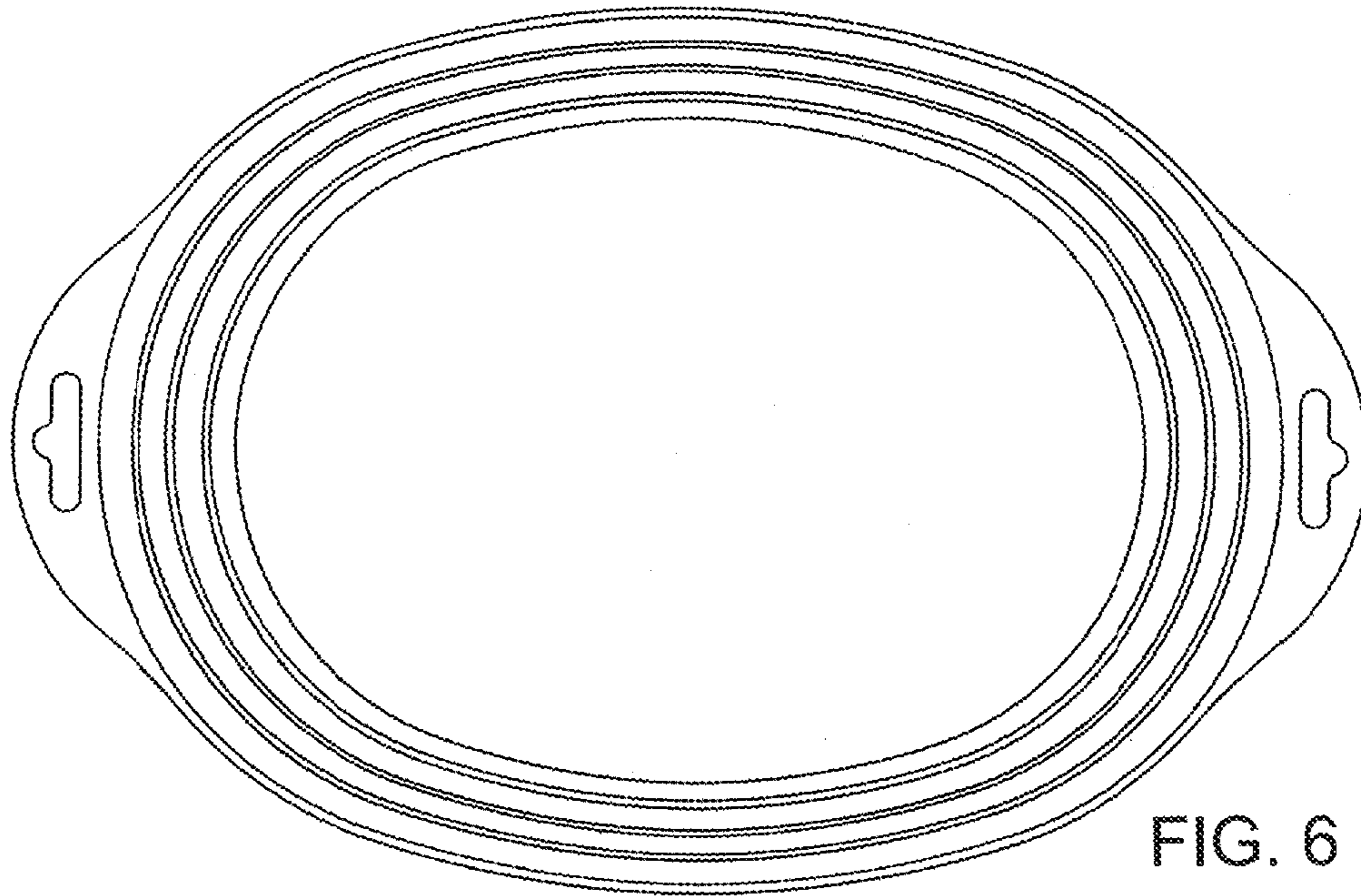

FIG. 6

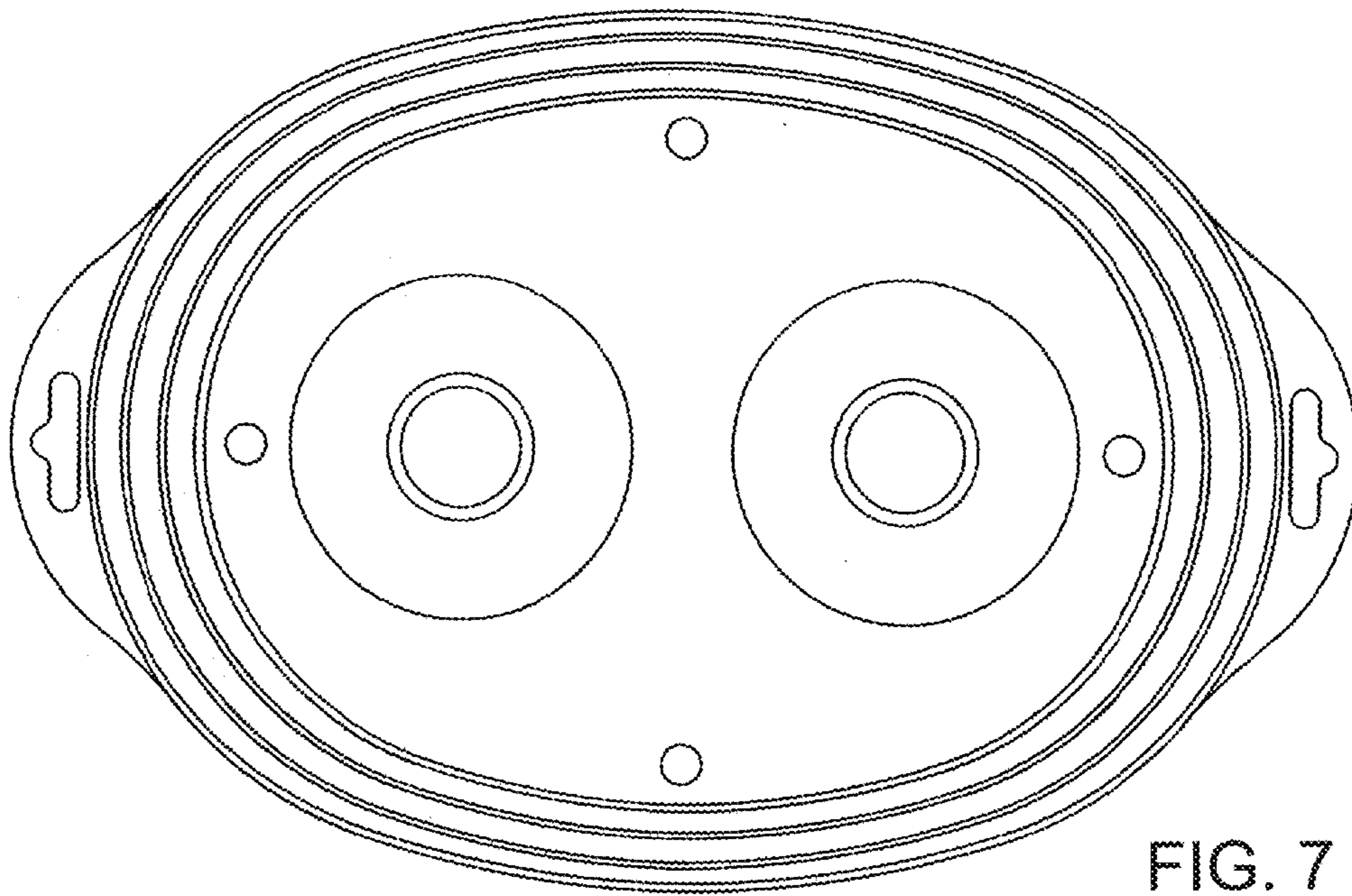

FIG. 7