



US00D669682S

(12) **United States Design Patent**  
**Crifasi**

(10) **Patent No.:** **US D669,682 S**  
(45) **Date of Patent:** **\*\* Oct. 30, 2012**

(54) **HIP BAG**

(76) Inventor: **Kathy Dahl Crifasi**, San Clemente, CA  
(US)

(\*\*) Term: **14 Years**

(21) Appl. No.: **29/413,503**

(22) Filed: **Feb. 16, 2012**

(51) **LOC (9) Cl.** ..... **03-01**

(52) **U.S. Cl.** ..... **D3/226**

(58) **Field of Classification Search** ..... D3/226,  
D3/215, 218–219, 224, 228, 212, 232–233,  
D3/247–249, 221; 150/114, 131, 152;  
224/240–241, 245, 251, 274, 664, 667, 669,  
224/676–677, 934; 383/63, 111, 113  
See application file for complete search history.

(56) **References Cited**

U.S. PATENT DOCUMENTS

2,474,495	A *	6/1949	Pollak	.....	224/245
D414,929	S *	10/1999	Brucki	.....	D3/226
D490,238	S *	5/2004	Bristel	.....	D3/226
D490,974	S *	6/2004	Wagner, II	.....	D3/226
D537,625	S *	3/2007	Michelin et al.	.....	D3/226

\* cited by examiner

*Primary Examiner* — Catheri Oliver-Garcia

(74) *Attorney, Agent, or Firm* — Fredrikson & Byron, P.A.

(57) **CLAIM**

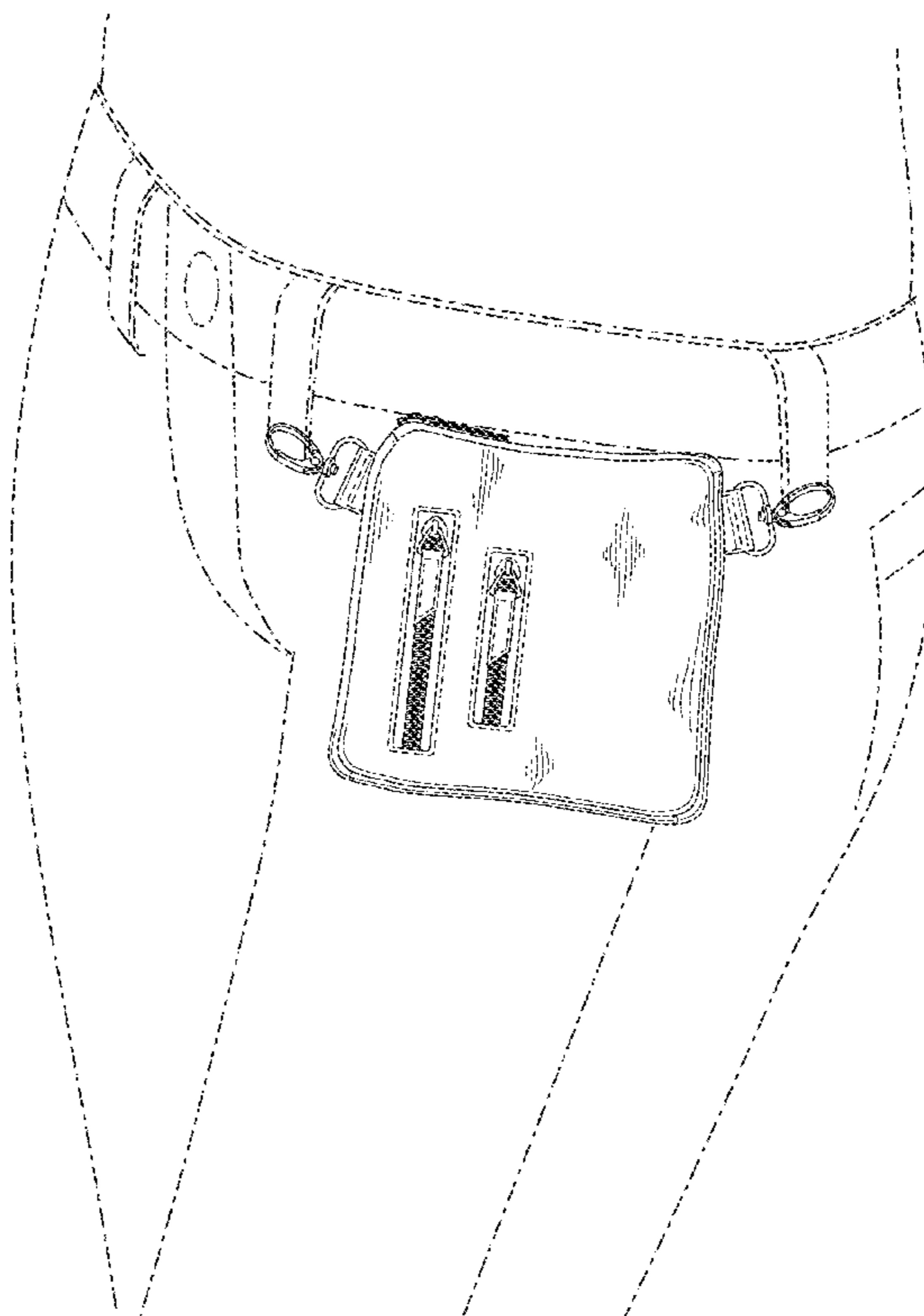
I claim the ornamental design for a hip bag, as shown and described.

**DESCRIPTION**

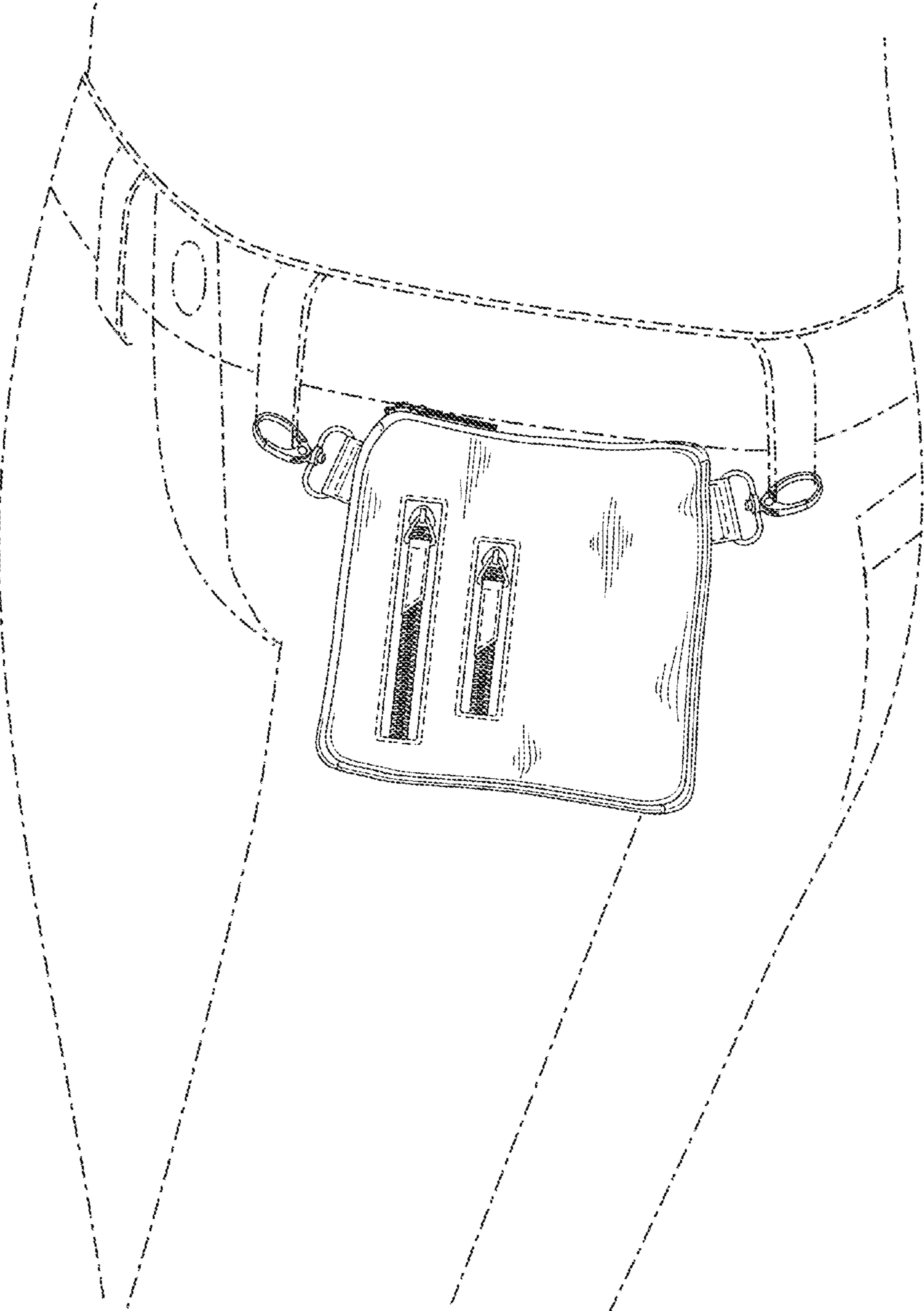
FIG. 1 is a perspective of my new design for a hip bag, according to a first embodiment that includes zippers; FIG. 2 is a front view thereof; FIG. 3 is a rear view thereof; FIG. 4 is a right side view thereof; FIG. 5 is a left side view thereof; FIG. 6 is a top view thereof; FIG. 7 is a bottom view thereof; FIG. 8 is a perspective of my new design for a hip bag, according to a second embodiment that does not include zippers; FIG. 9 is a front view thereof; FIG. 10 is a rear view thereof; FIG. 11 is a right side view thereof; FIG. 12 is a left side view thereof; FIG. 13 is a top view thereof; and, FIG. 14 is a bottom view thereof.

The broken lines showing a pair of pants in FIGS. 1 and 8 are included for the purpose of illustrating the hip bag in use, and form no part of the claimed design. The broken lines shown on the hip bag itself are stitching.

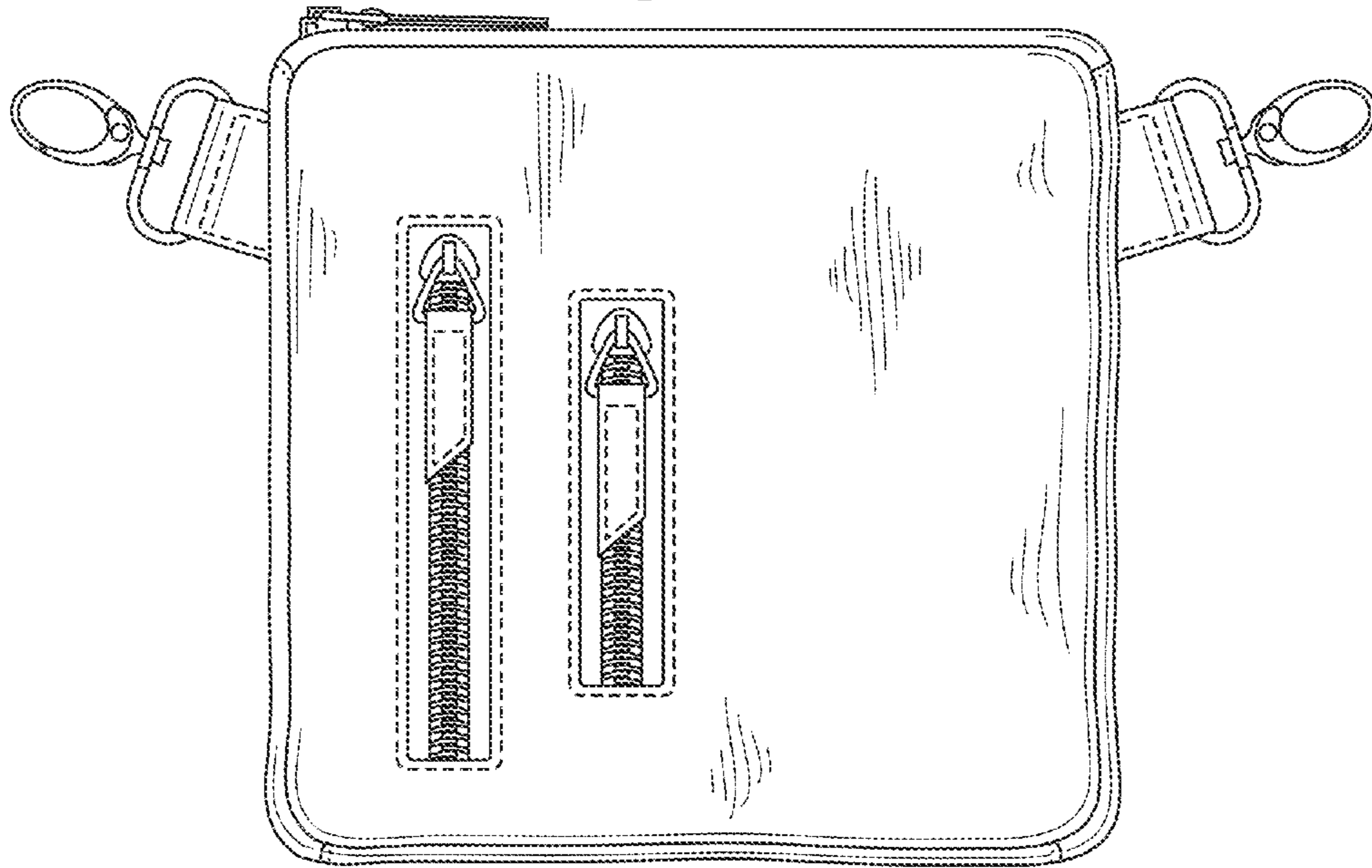
**1 Claim, 6 Drawing Sheets**



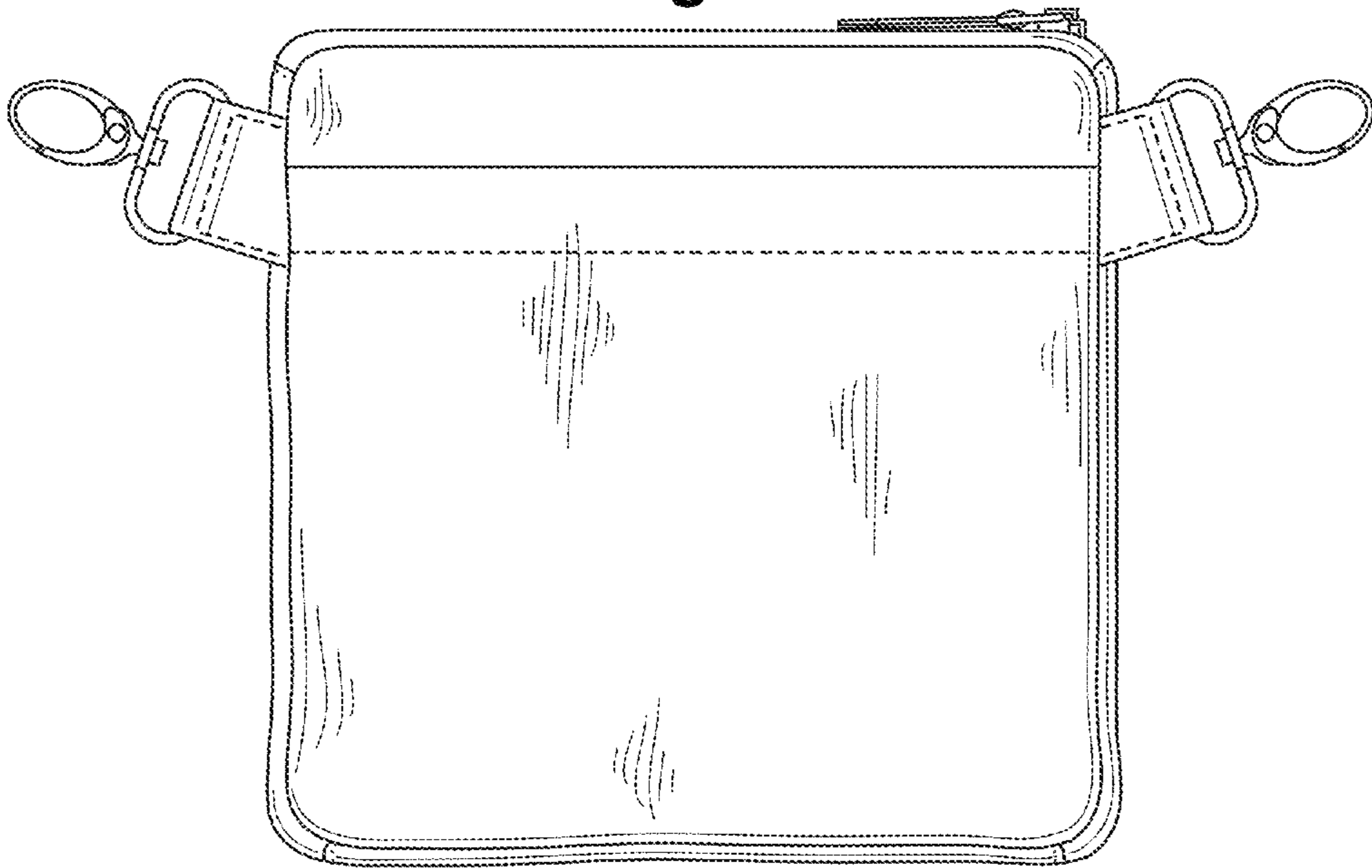
**Fig. 1**



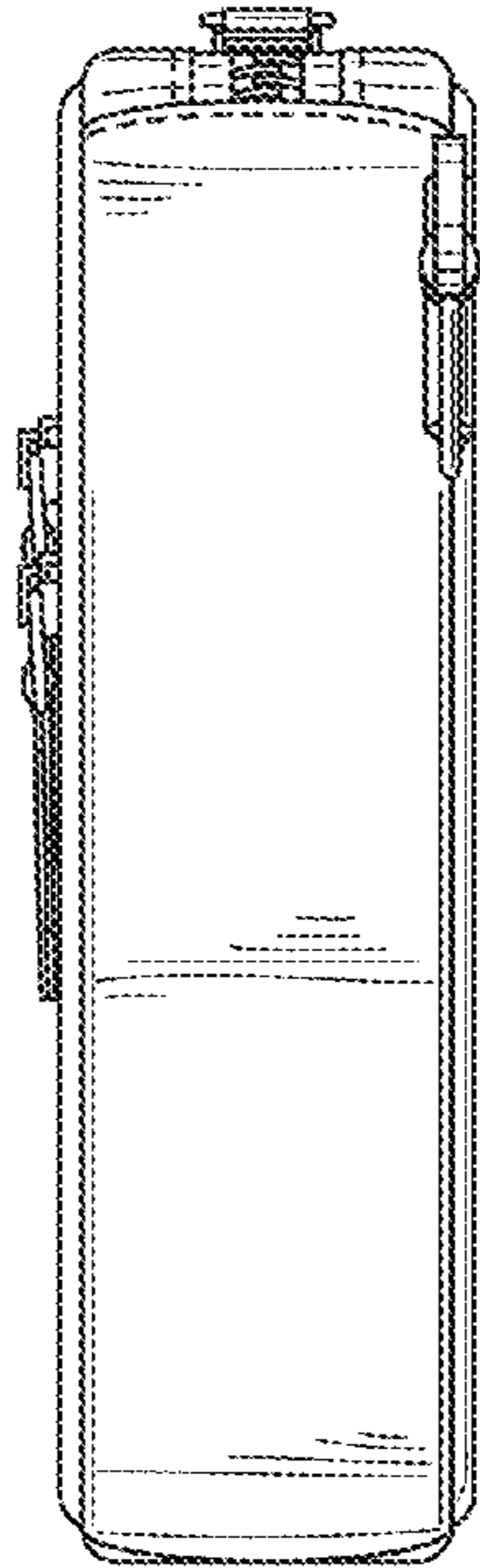
**Fig. 2**



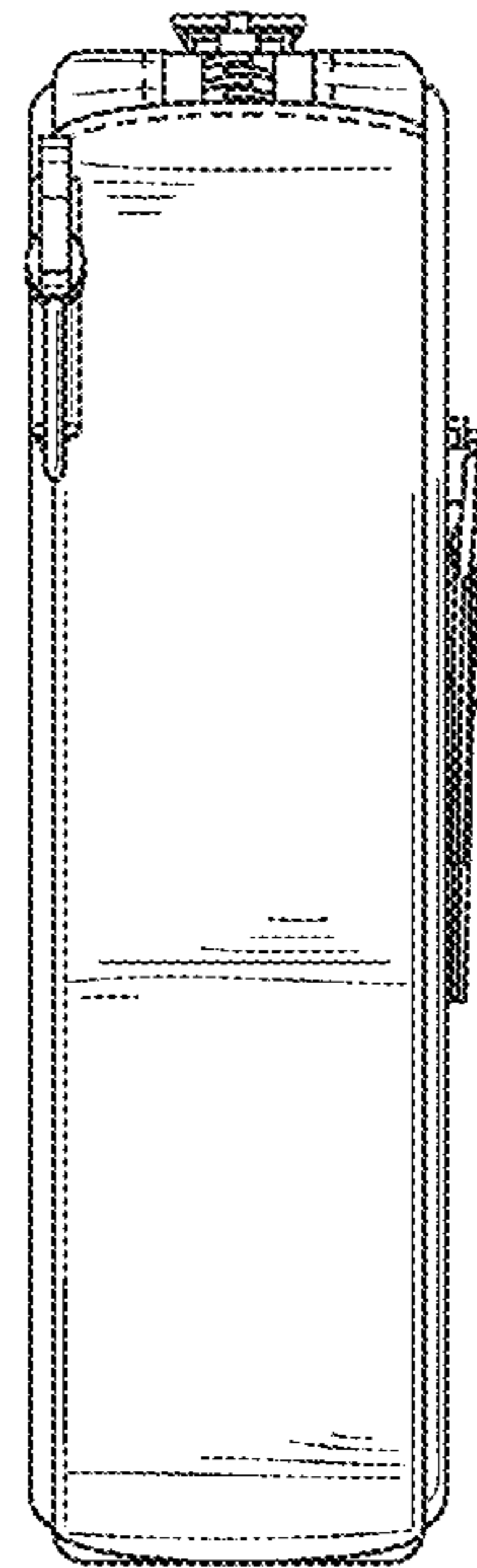
**Fig. 3**



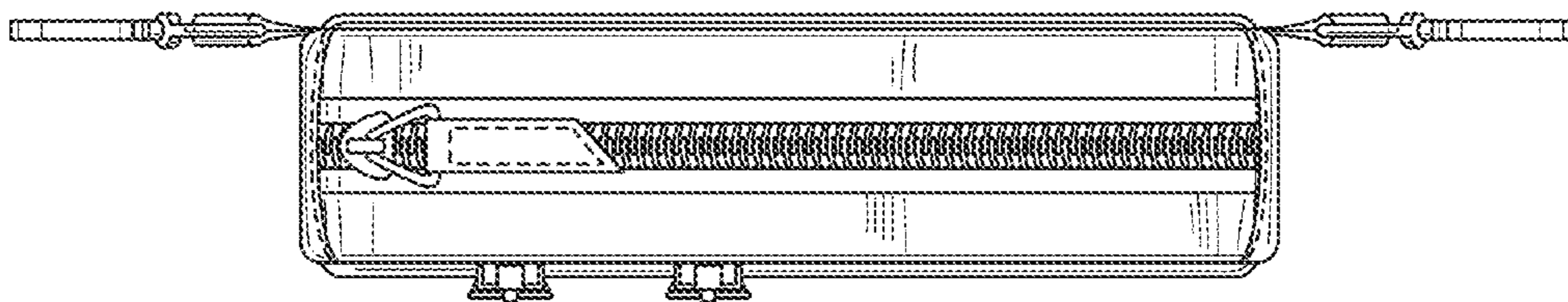
**Fig. 4**



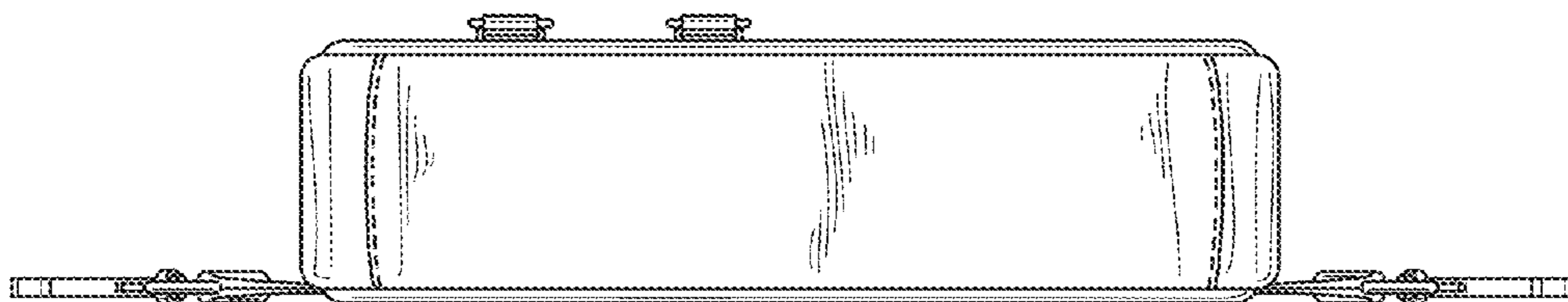
**Fig. 5**



**Fig. 6**

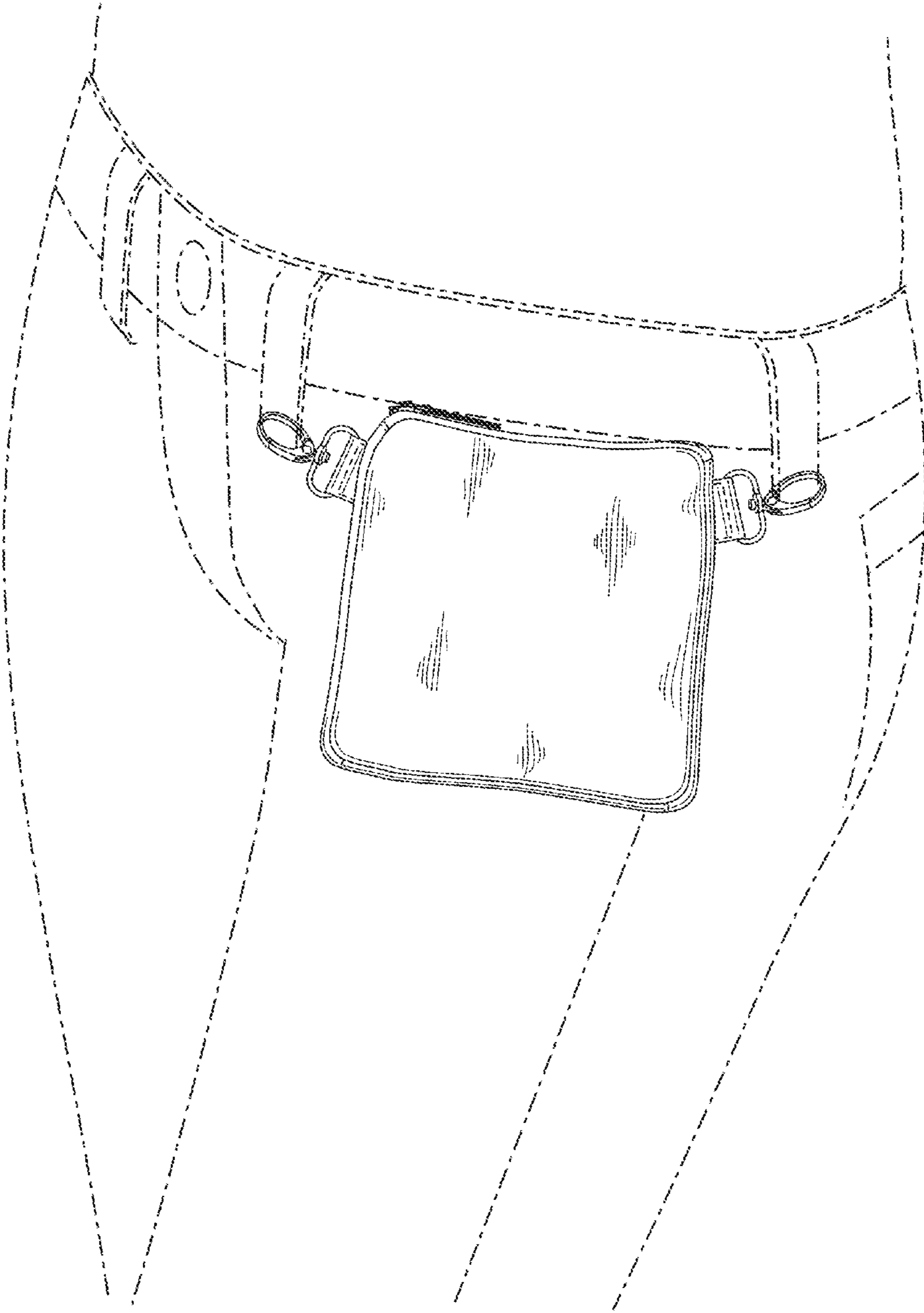


**Fig. 7**

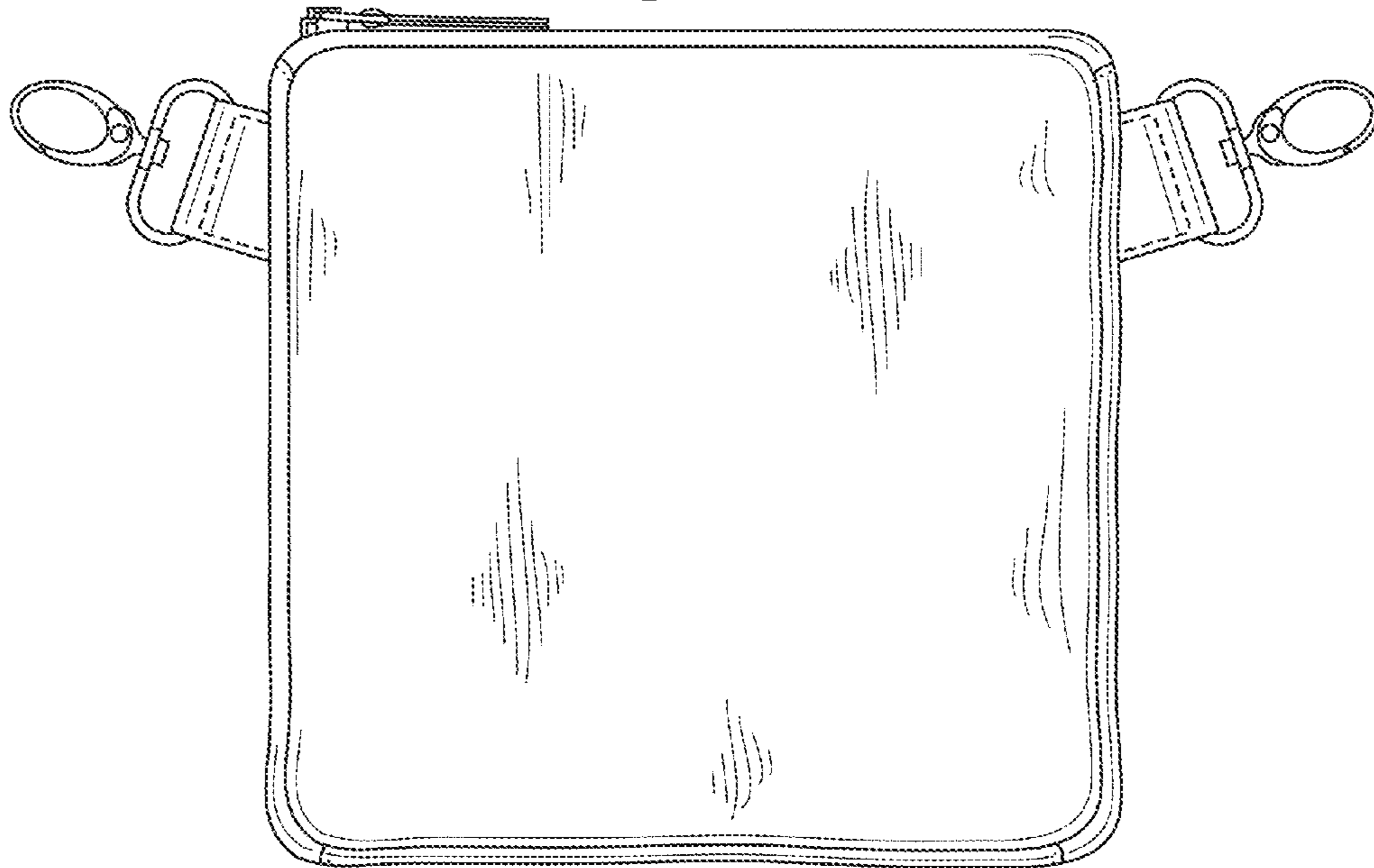




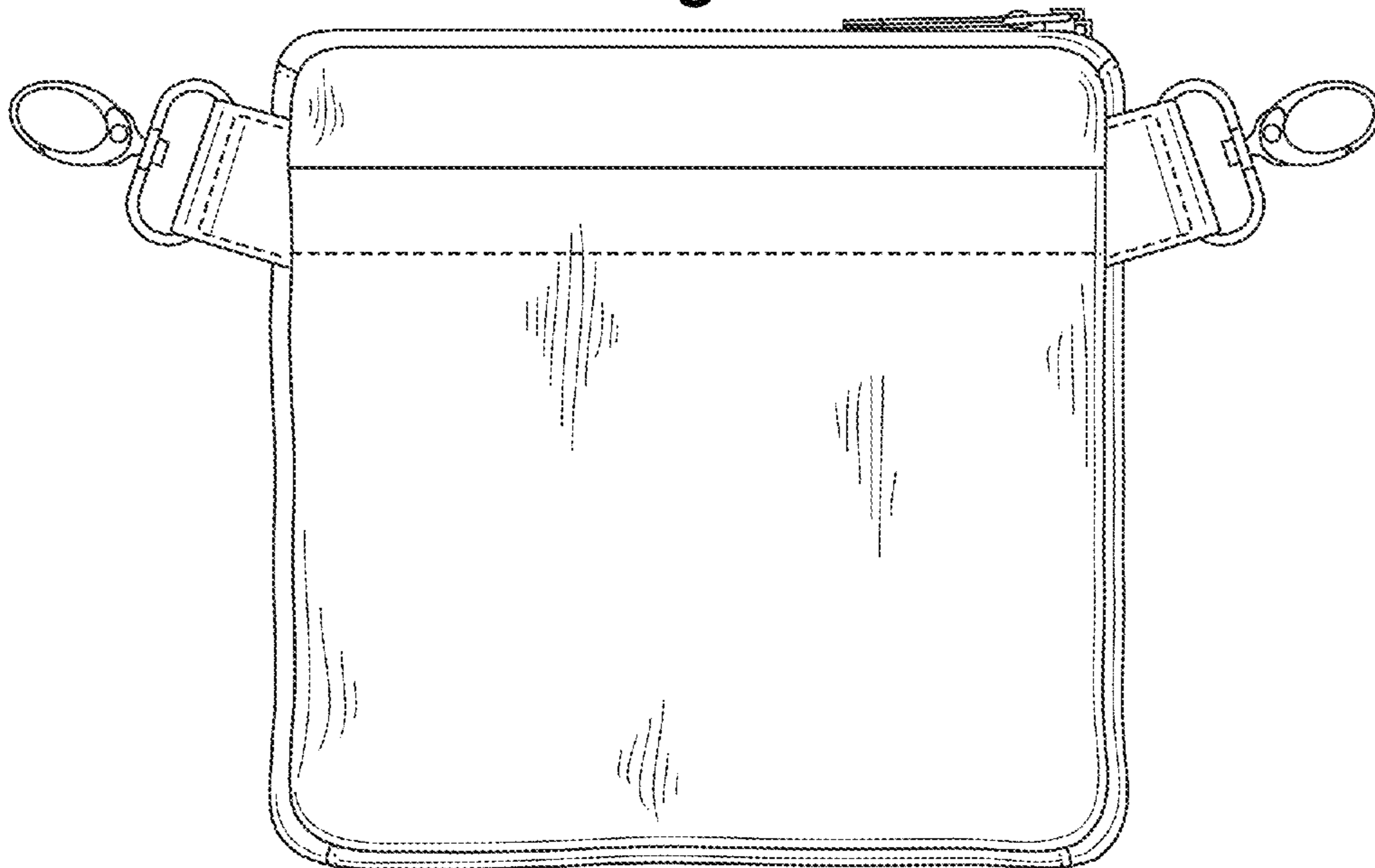
**Fig. 8**



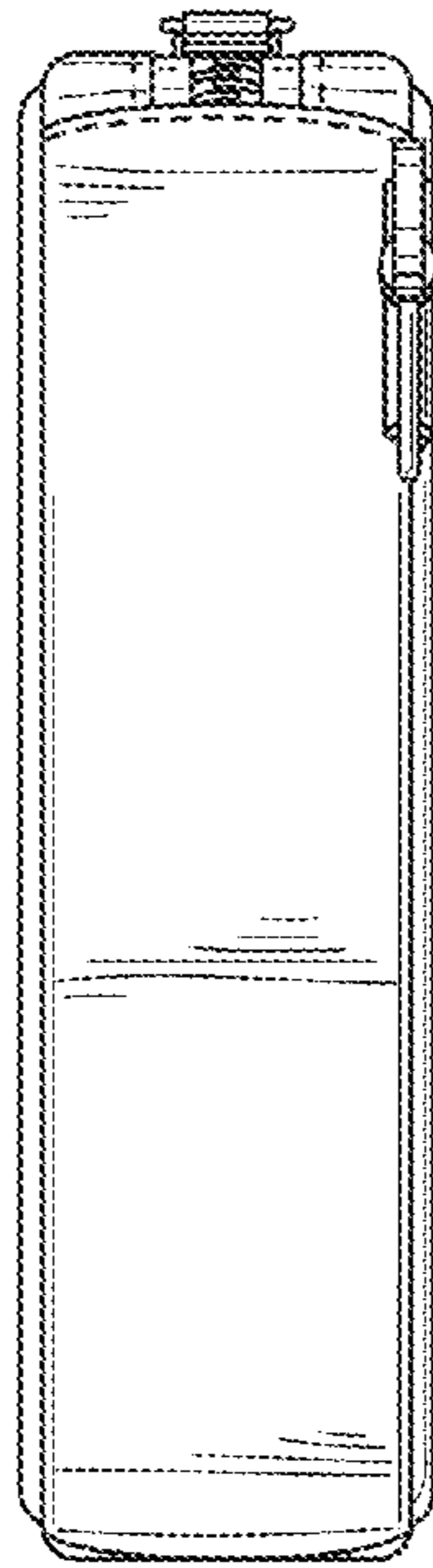
**Fig. 9**



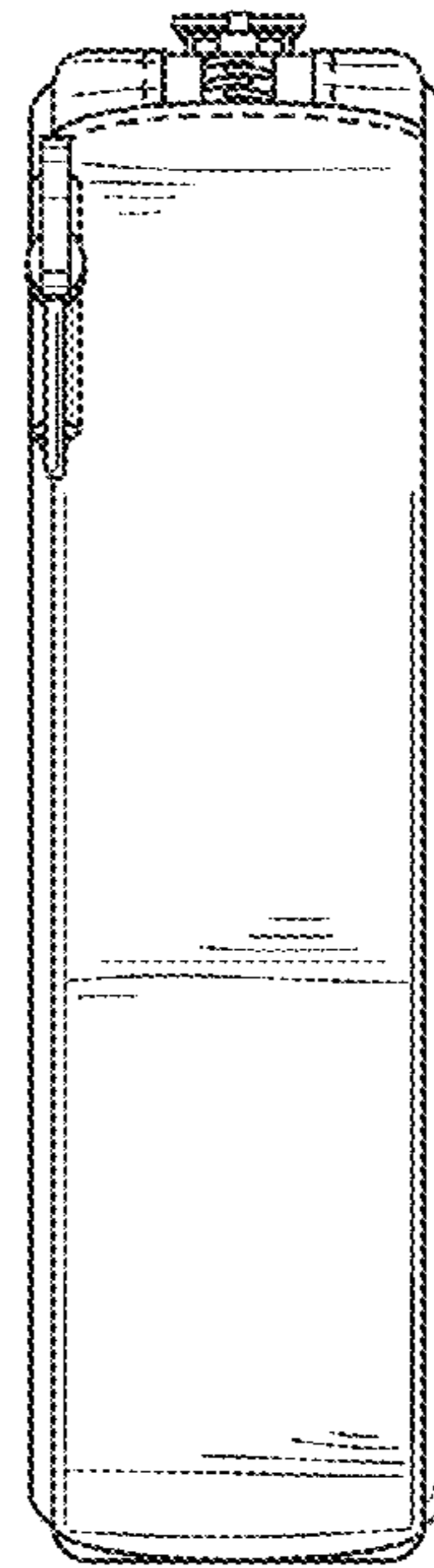
**Fig. 10**



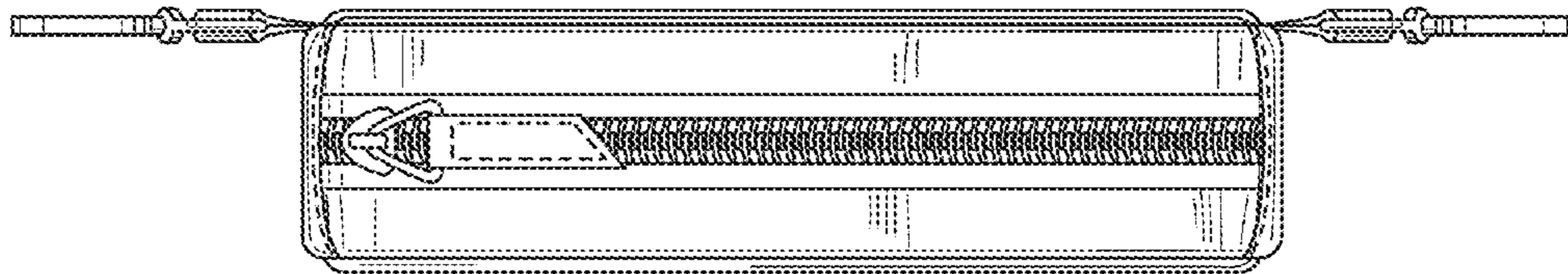
**Fig. 11**



**Fig. 12**



**Fig. 13**



**Fig. 14**

