

US00D669626S

(12) **United States Design Patent**  
**Huang**

(10) **Patent No.:** **US D669,626 S**

(45) **Date of Patent:** **\*\* Oct. 23, 2012**

(54) **TABLE LAMP**

(76) Inventor: **Huo-Tu Huang**, New Taipei (TW)

(\*\*) Term: **14 Years**

(21) Appl. No.: **29/409,178**

(22) Filed: **Dec. 21, 2011**

(51) **LOC (9) Cl.** ..... **26-01**

(52) **U.S. Cl.** ..... **D26/107**

(58) **Field of Classification Search** ..... D26/24,  
D26/61-67, 93, 102, 104-105, 107-109;  
362/509, 516, 523, 186, 217, 255, 257, 277,  
362/317, 319, 351, 354, 355, 357, 358, 362,  
362/382, 410, 413, 417, 806

See application file for complete search history.

(56) **References Cited**

U.S. PATENT DOCUMENTS

D500,156 S \* 12/2004 Kao ..... D26/61  
D513,088 S \* 12/2005 Baarman et al. .... D26/106

D589,645 S \* 3/2009 Citterio ..... D26/107  
D619,287 S \* 7/2010 Liu ..... D26/62  
D621,980 S \* 8/2010 Munger ..... D26/61  
D636,513 S \* 4/2011 Furtsch ..... D26/61  
D648,057 S \* 11/2011 Copeland ..... D26/65

\* cited by examiner

*Primary Examiner* — Brian N Vinson

(57) **CLAIM**

I claim the ornamental design for table lamp, as shown and described.

**DESCRIPTION**

FIG. 1. is a perspective view of table lamp showing my new design  
FIG. 2. is a front elevational view thereof;  
FIG. 3. is a rear elevational view thereof;  
FIG. 4. is a left side elevational view thereof;  
FIG. 5. is a right side elevational view thereof;  
FIG. 6. is a top plan view thereof; and,  
FIG. 7. is a bottom plan view thereof.

**1 Claim, 6 Drawing Sheets**

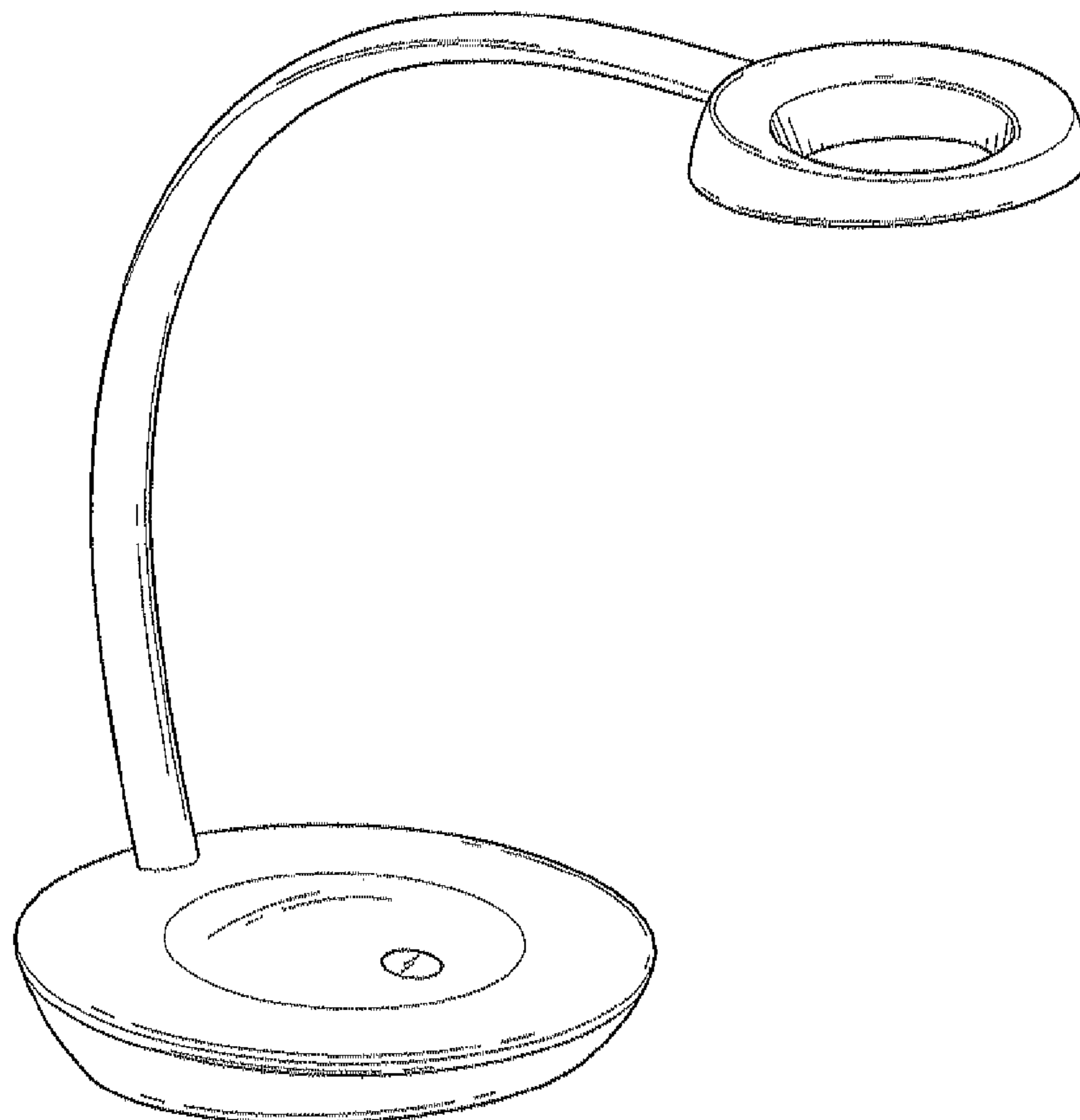

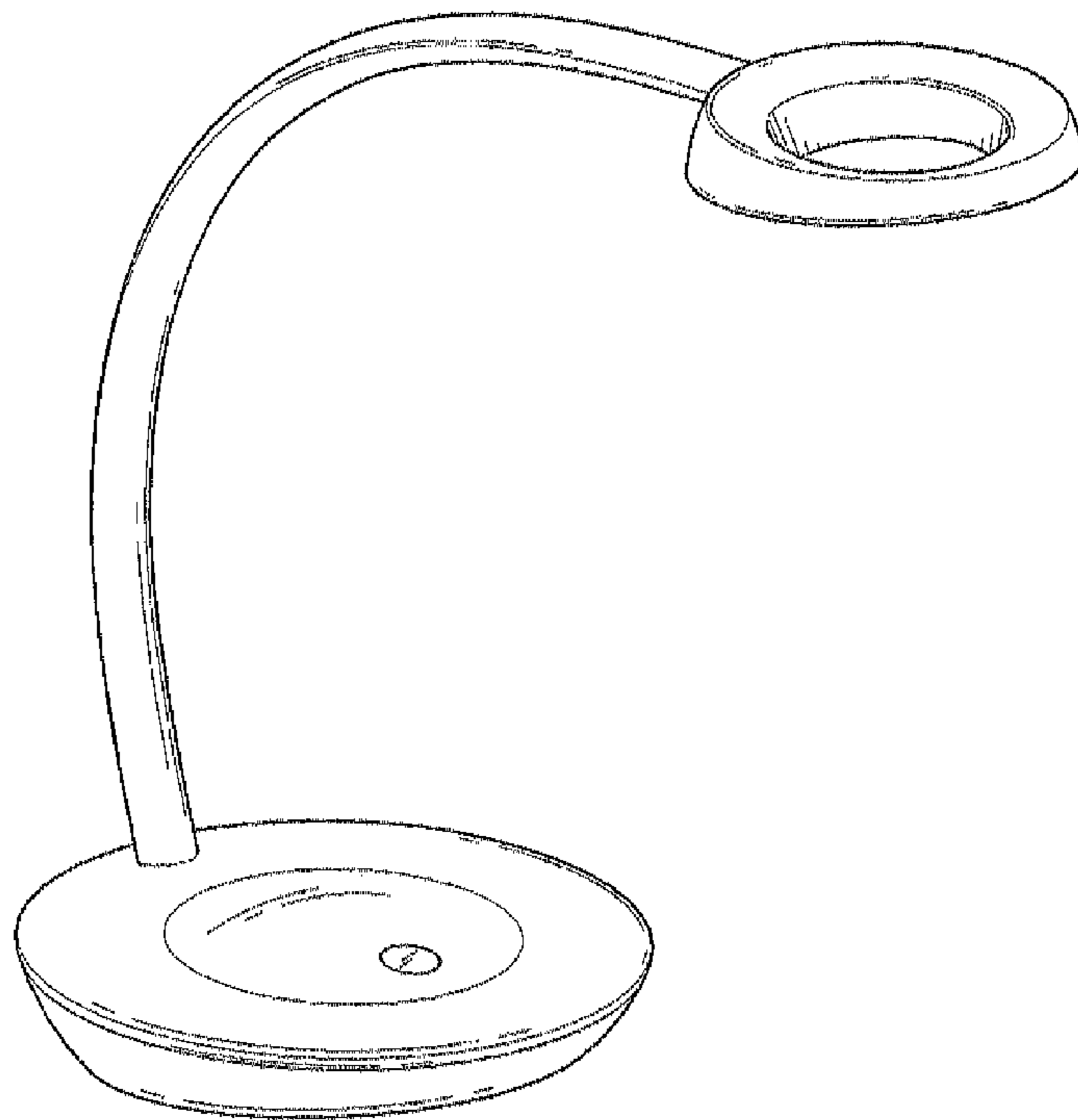

*FIG. 1*

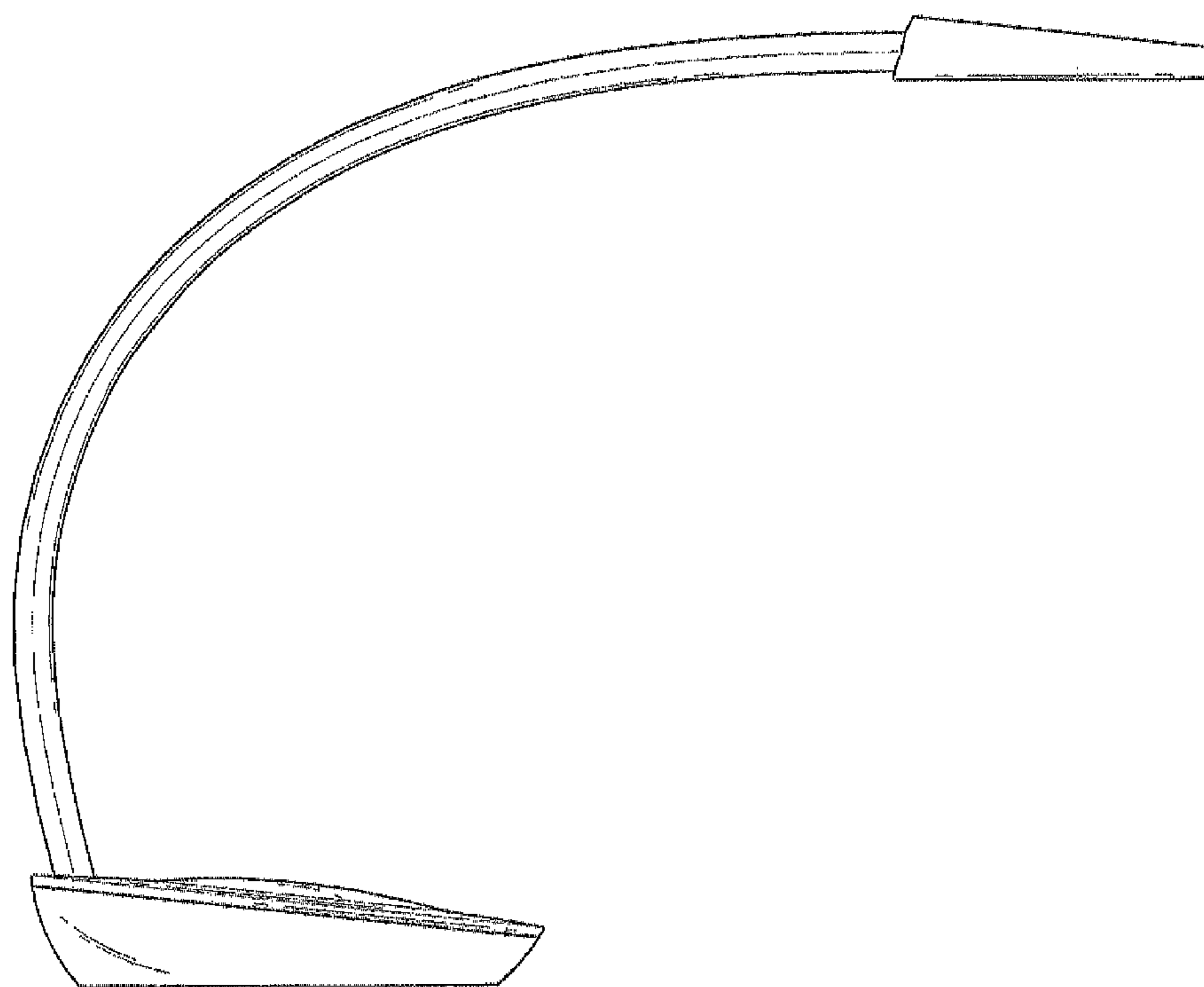
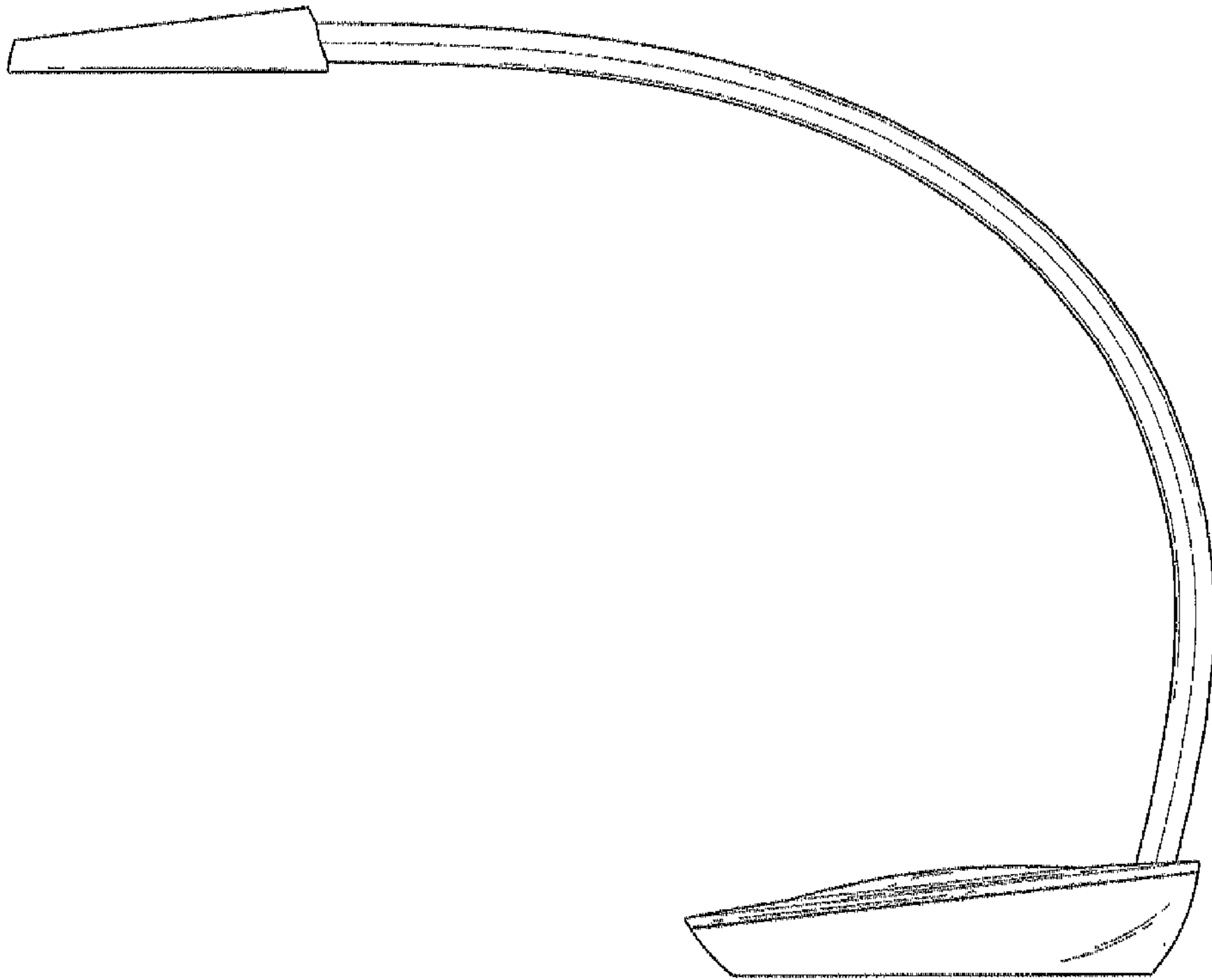
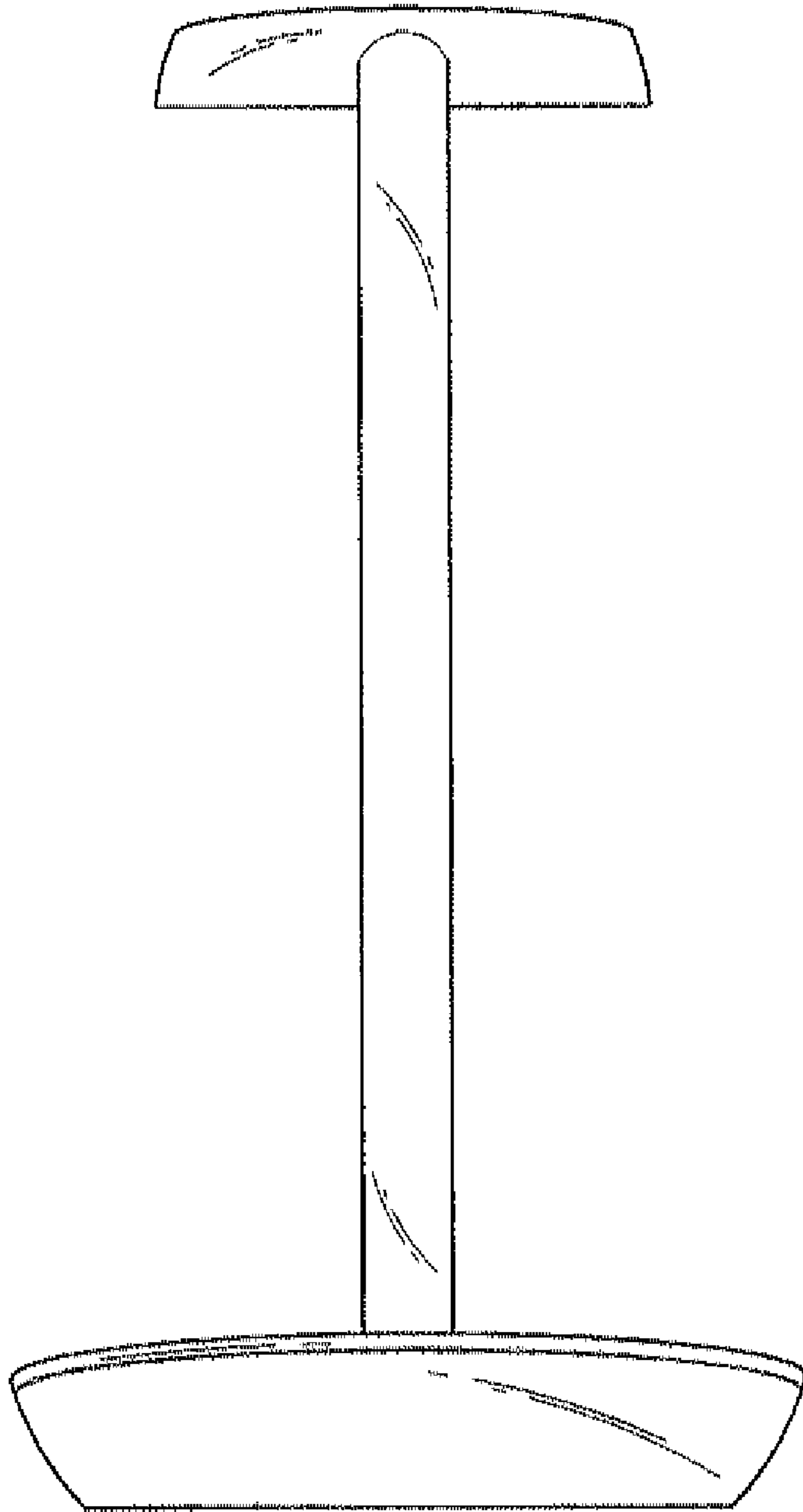

FIG.2



*FIG. 3*



**FIG. 4**

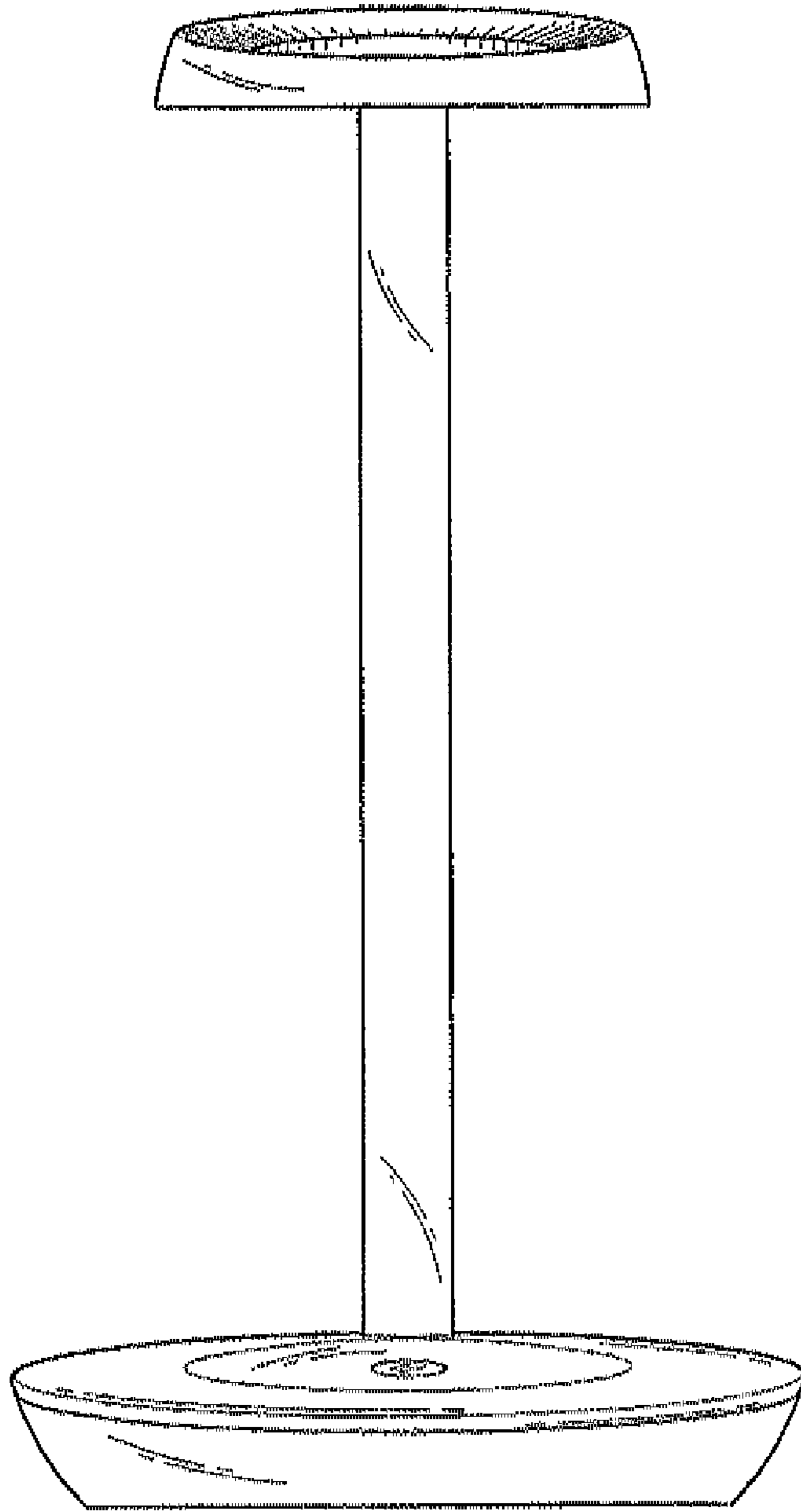

**FIG. 5**

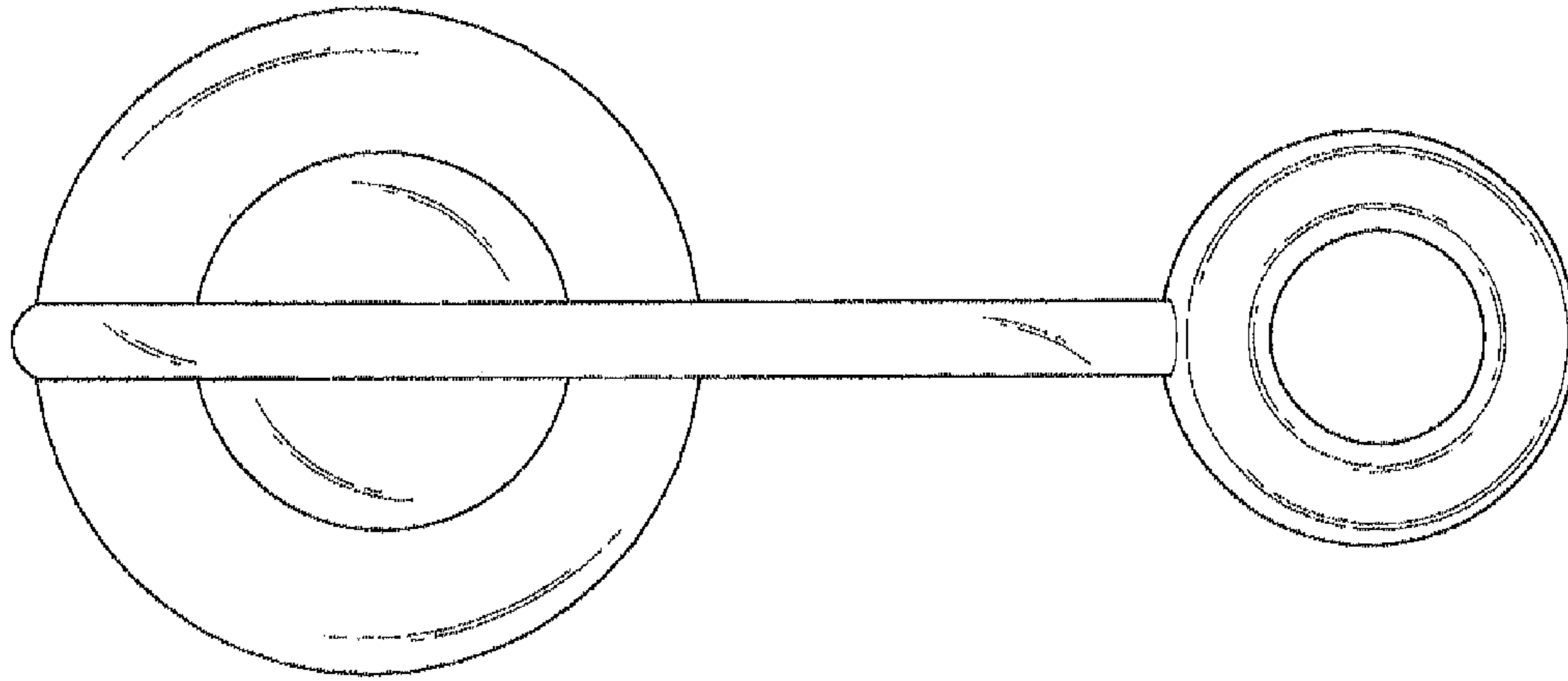

*FIG. 6*

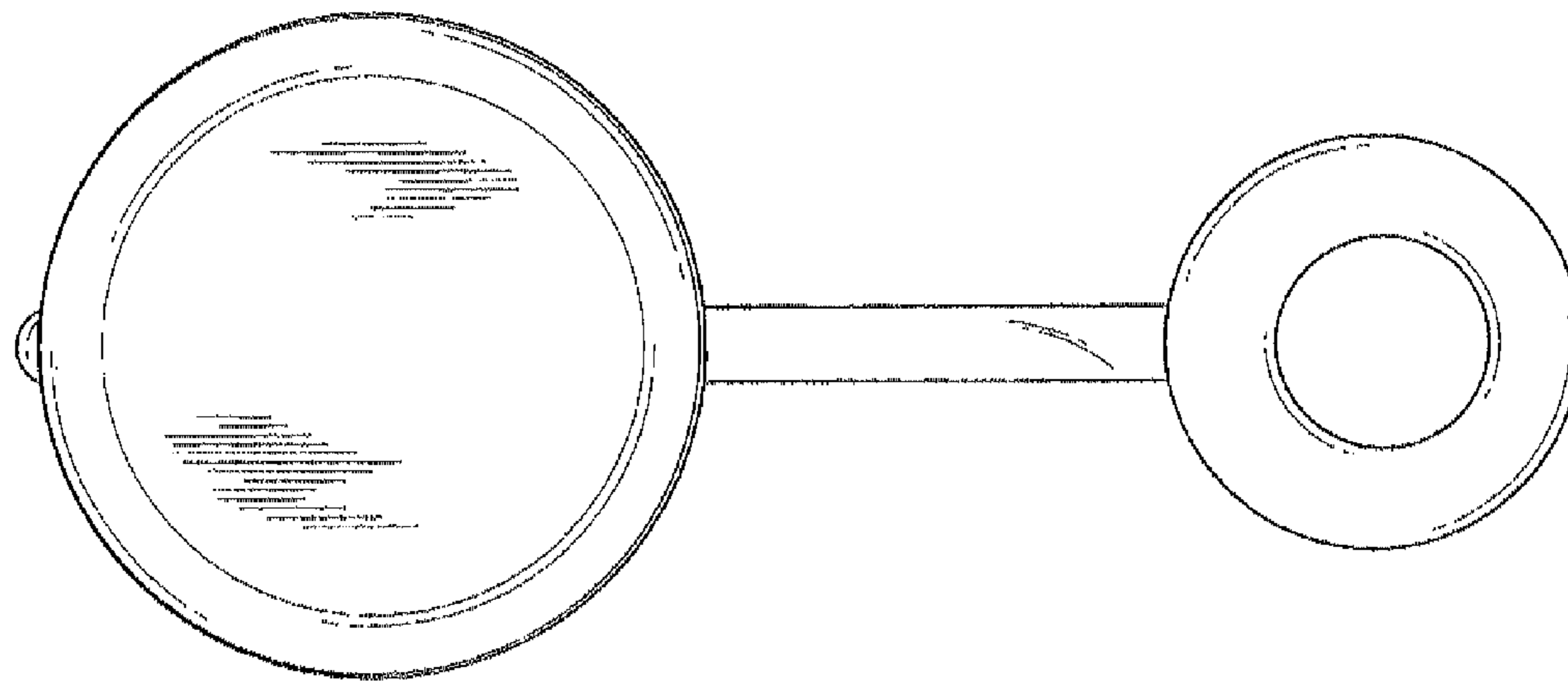

*FIG. 7*