



US00D669574S

(12) **United States Design Patent**
Nordström

(10) **Patent No.:** **US D669,574 S**

(45) **Date of Patent:** **** Oct. 23, 2012**

(54) **HEARING PROTECTOR**

(76) Inventor: **Dag Nordström**, Västerås (SE)

(**) Term: **14 Years**

(21) Appl. No.: **29/387,465**

(22) Filed: **Mar. 14, 2011**

(30) **Foreign Application Priority Data**

Sep. 16, 2010 (EM) 001755711

(51) **LOC (9) Cl.** **24-04**

(52) **U.S. Cl.** **D24/106; D14/205**

(58) **Field of Classification Search** D24/106;
D2/865-866; D14/205; 2/209; 128/864-867,
128/857; 181/129, 135-136; D29/108, 112
See application file for complete search history.

(56) **References Cited**

U.S. PATENT DOCUMENTS

3,505,684	A *	4/1970	Hutchinson et al.	2/209
3,562,816	A *	2/1971	Hutchinson	2/209
D245,202	S *	7/1977	Asker	D24/106
4,571,746	A *	2/1986	Gorike	D29/112
D305,072	S *	12/1989	Ferguson	D29/112

D323,043	S *	1/1992	Lofton	D29/112
D331,966	S *	12/1992	Gardner, Jr.	D24/106
D534,155	S *	12/2006	Obata	D14/205
D540,301	S *	4/2007	Obata	D14/205
D632,668	S *	2/2011	Brunner et al.	D14/205
D652,406	S *	1/2012	Lee et al.	D14/205

* cited by examiner

Primary Examiner — Wan Laymon

(74) *Attorney, Agent, or Firm* — Dilworth & Barrese, LLP.

(57) **CLAIM**

The ornamental design for a hearing protector, as shown and described.

DESCRIPTION

FIG. 1 is a left front perspective view of the hearing protector showing my new design;
FIG. 2 is atop plan view thereof;
FIG. 3 is a bottom plan view thereof;
FIG. 4 is a front elevational view thereof;
FIG. 5 is a rear elevational view thereof;
FIG. 6 is a right side elevational view thereof; and,
FIG. 7 is a left side elevational view thereof.

1 Claim, 5 Drawing Sheets

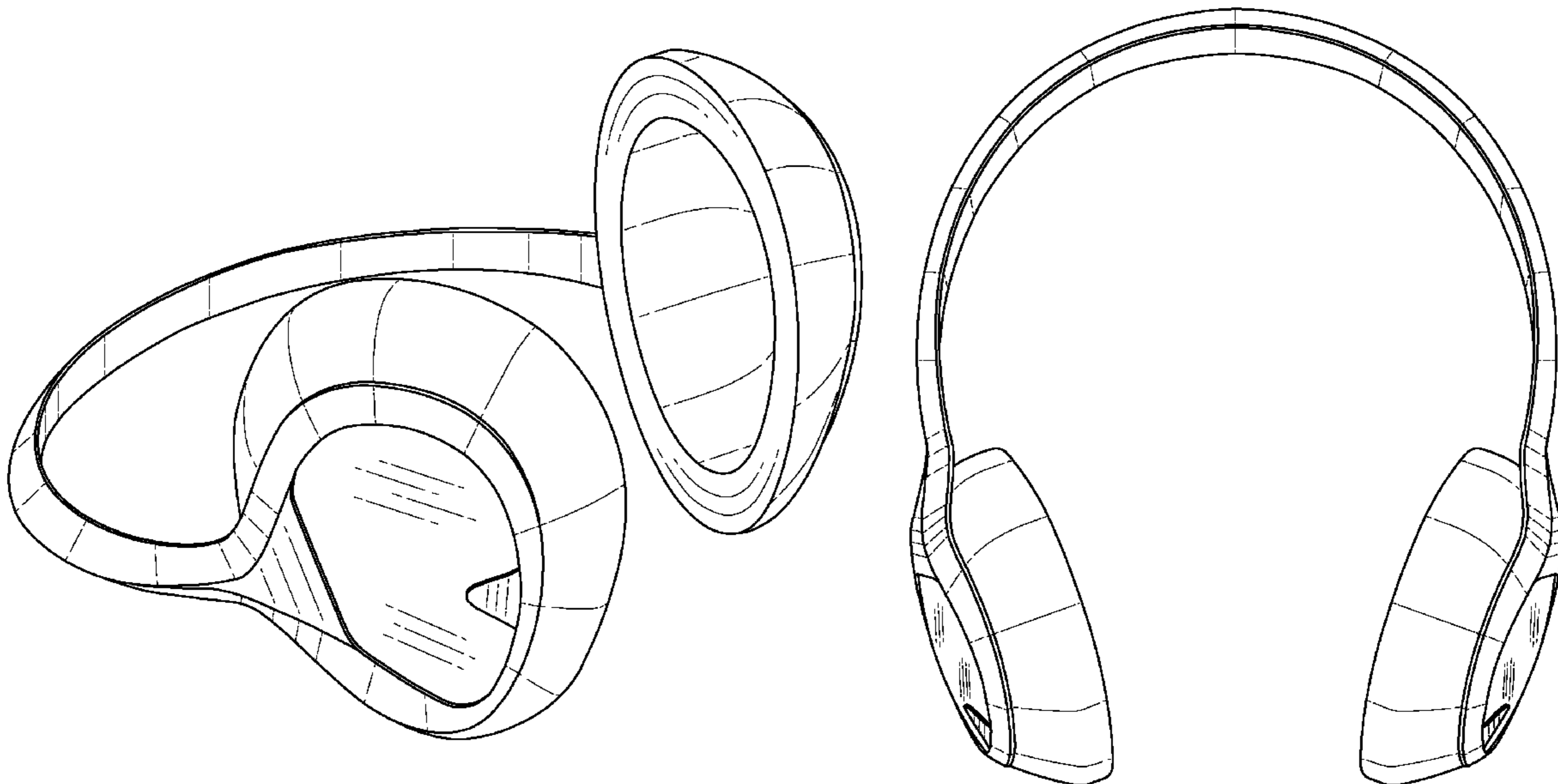

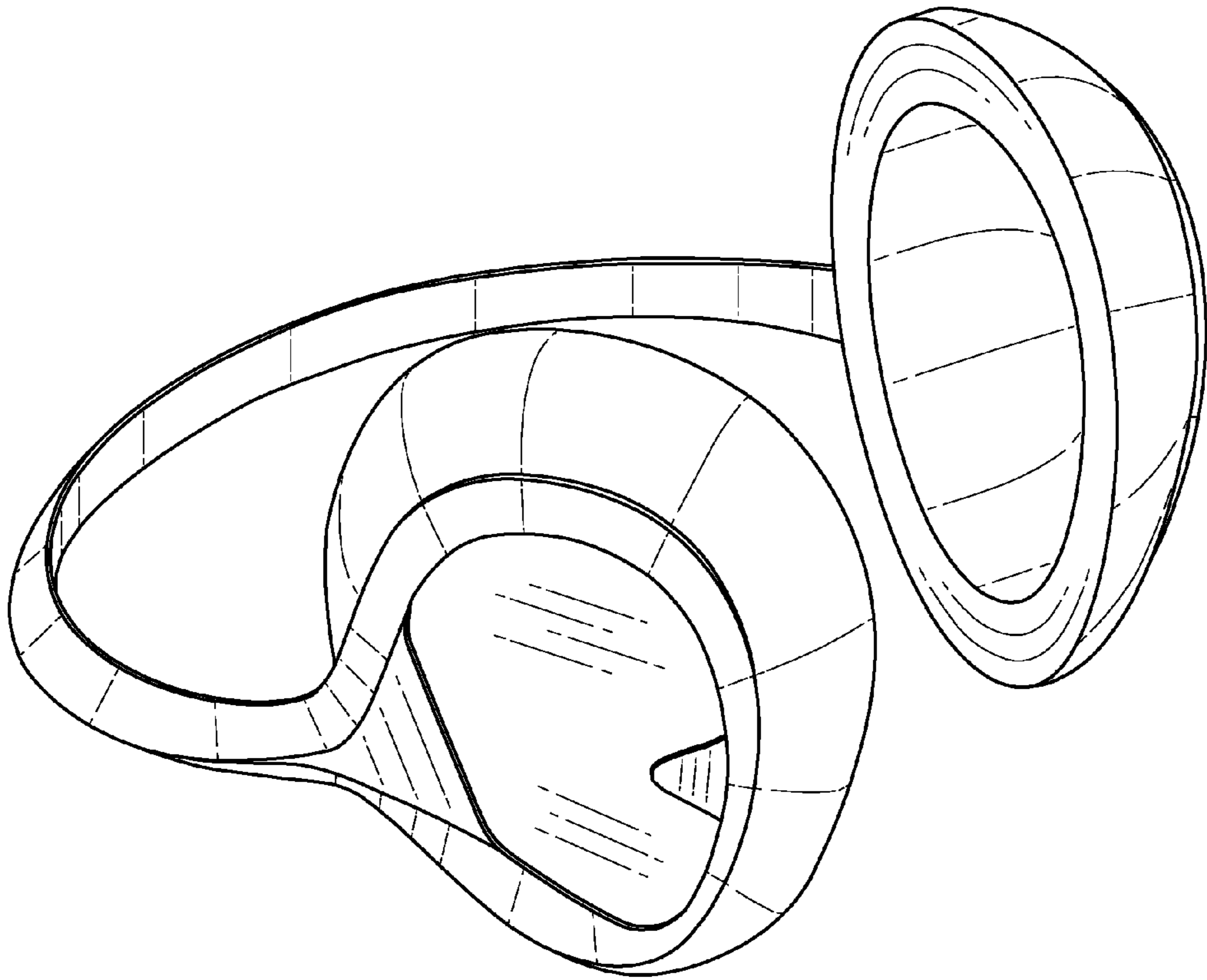

FIG. 1

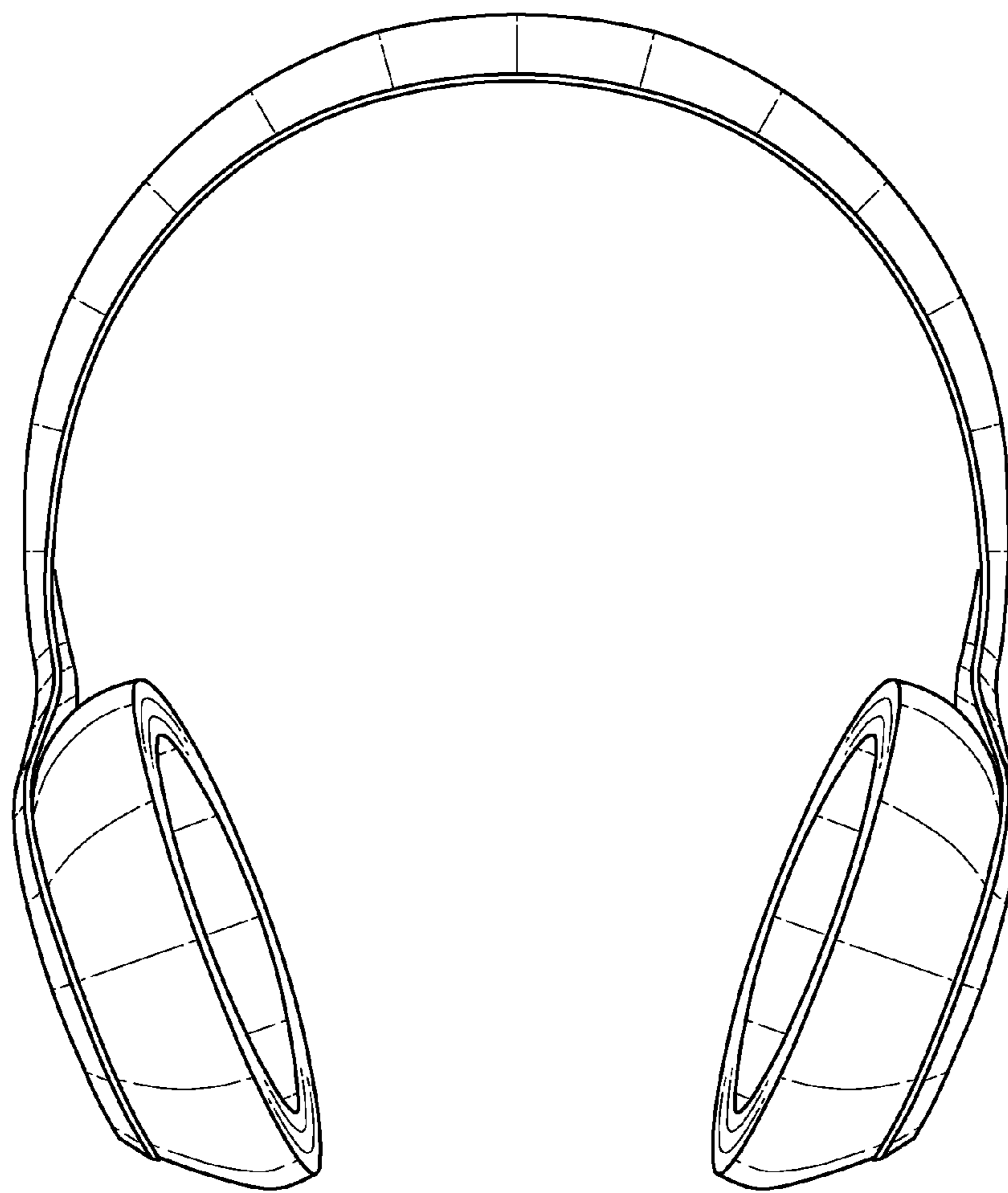

FIG. 2

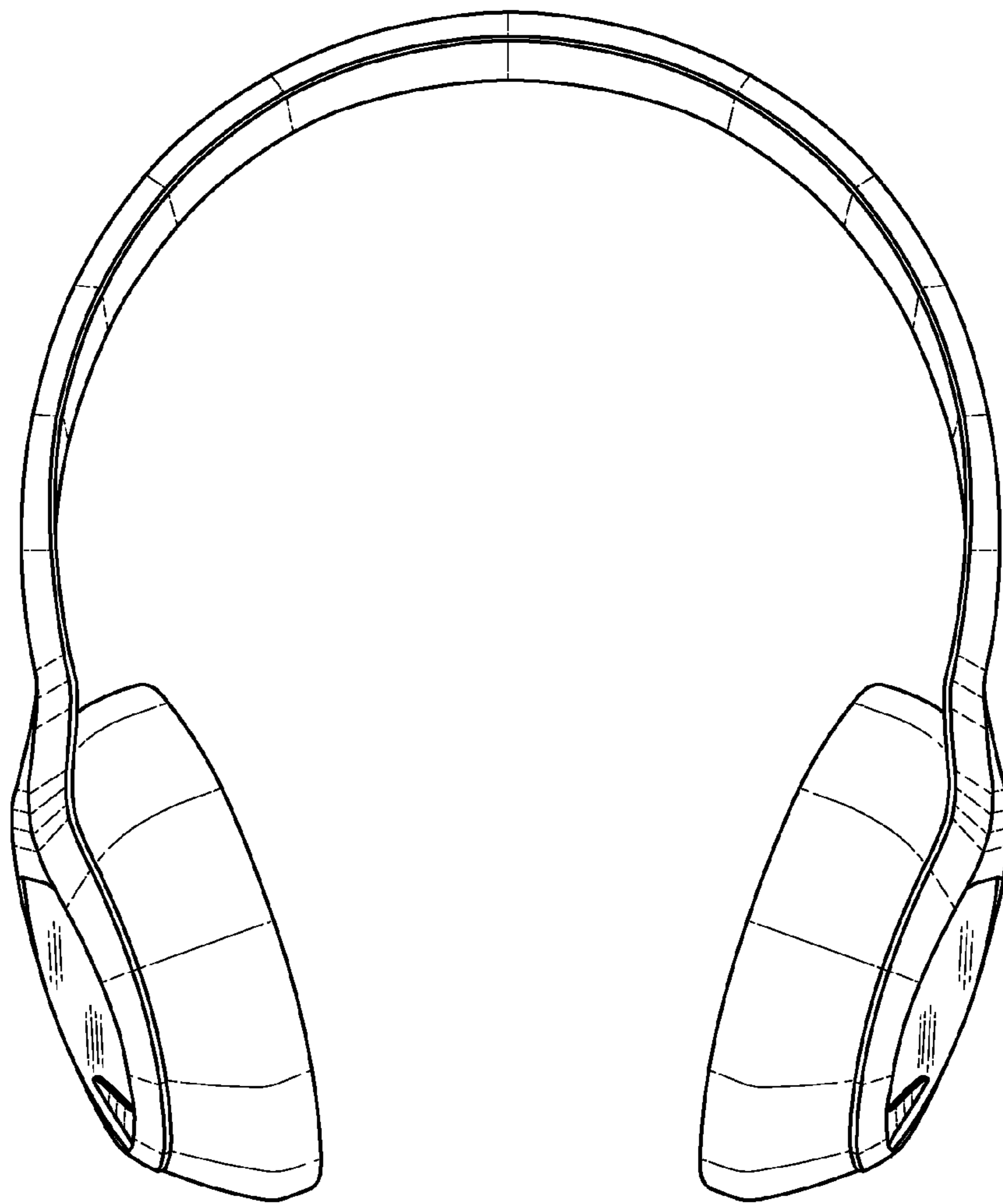

FIG. 3

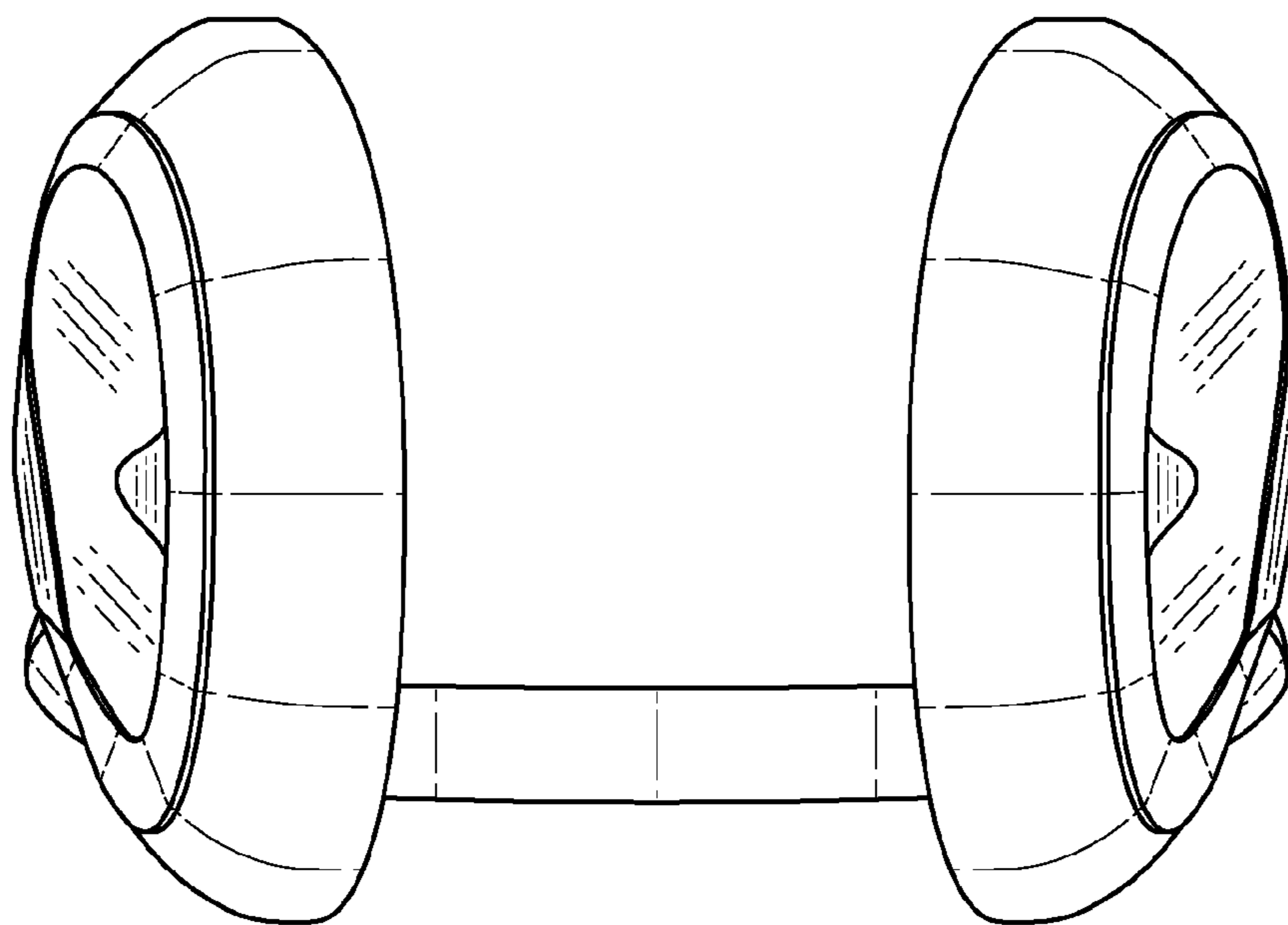

FIG. 4

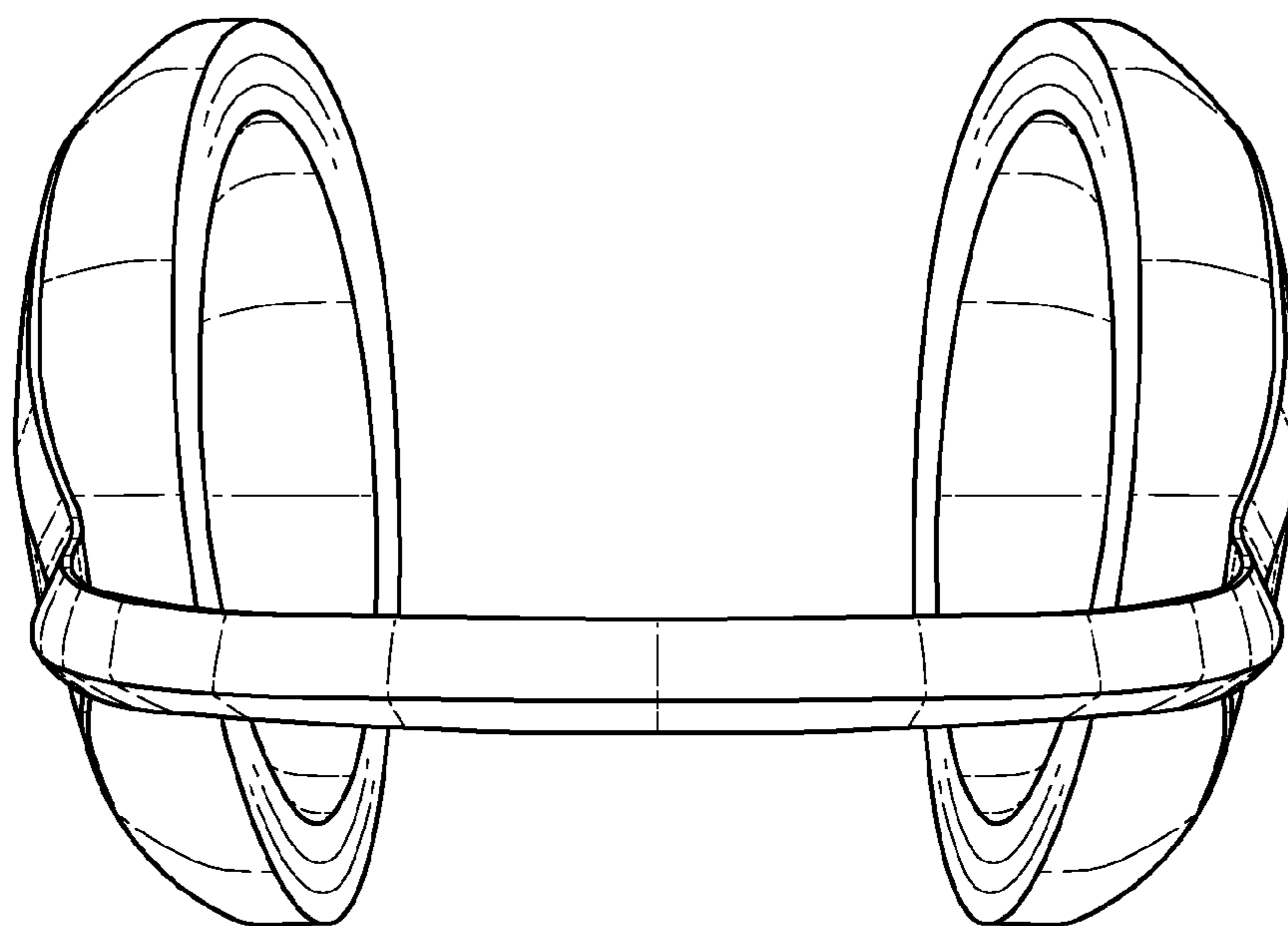

FIG. 5

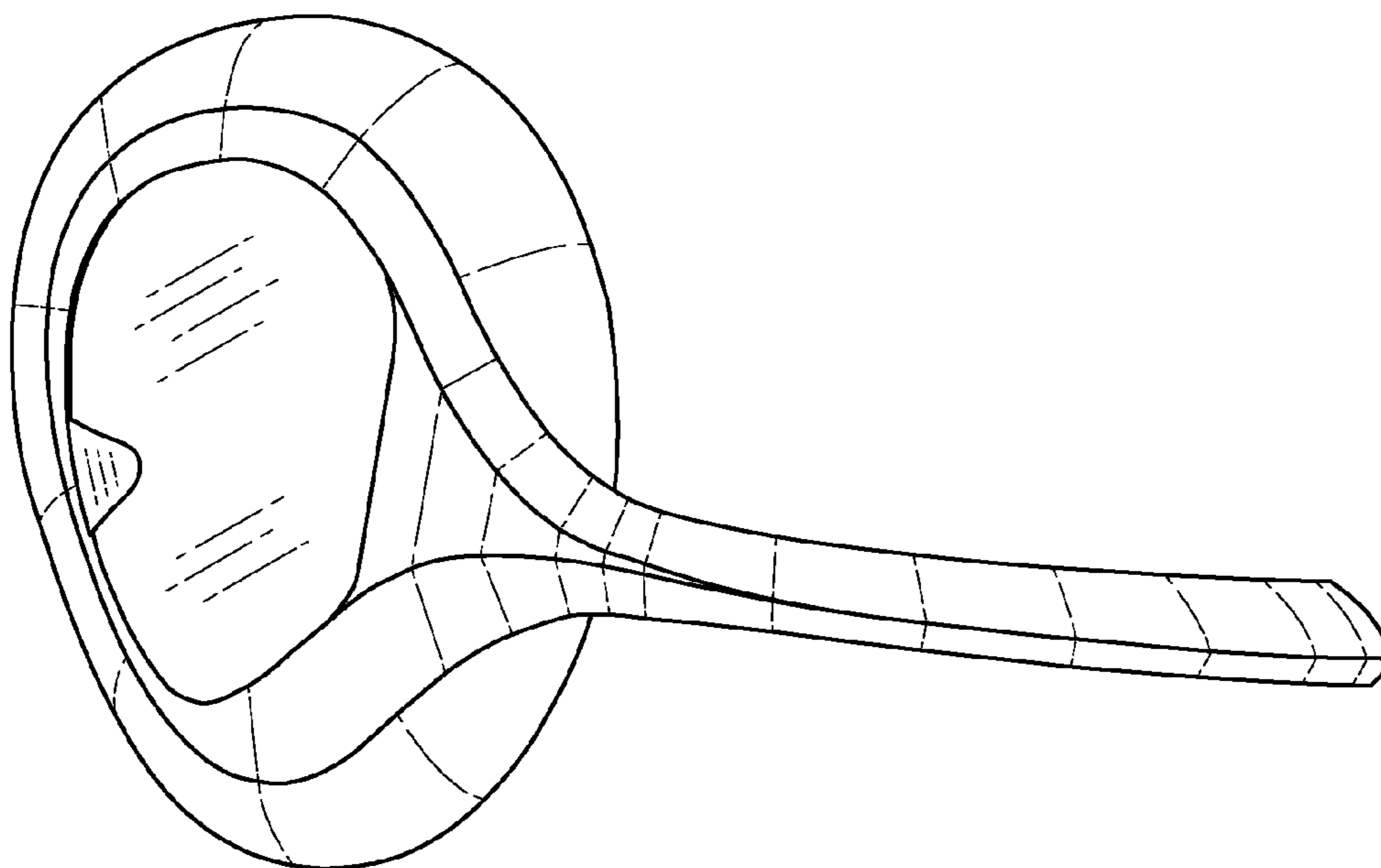

FIG. 6

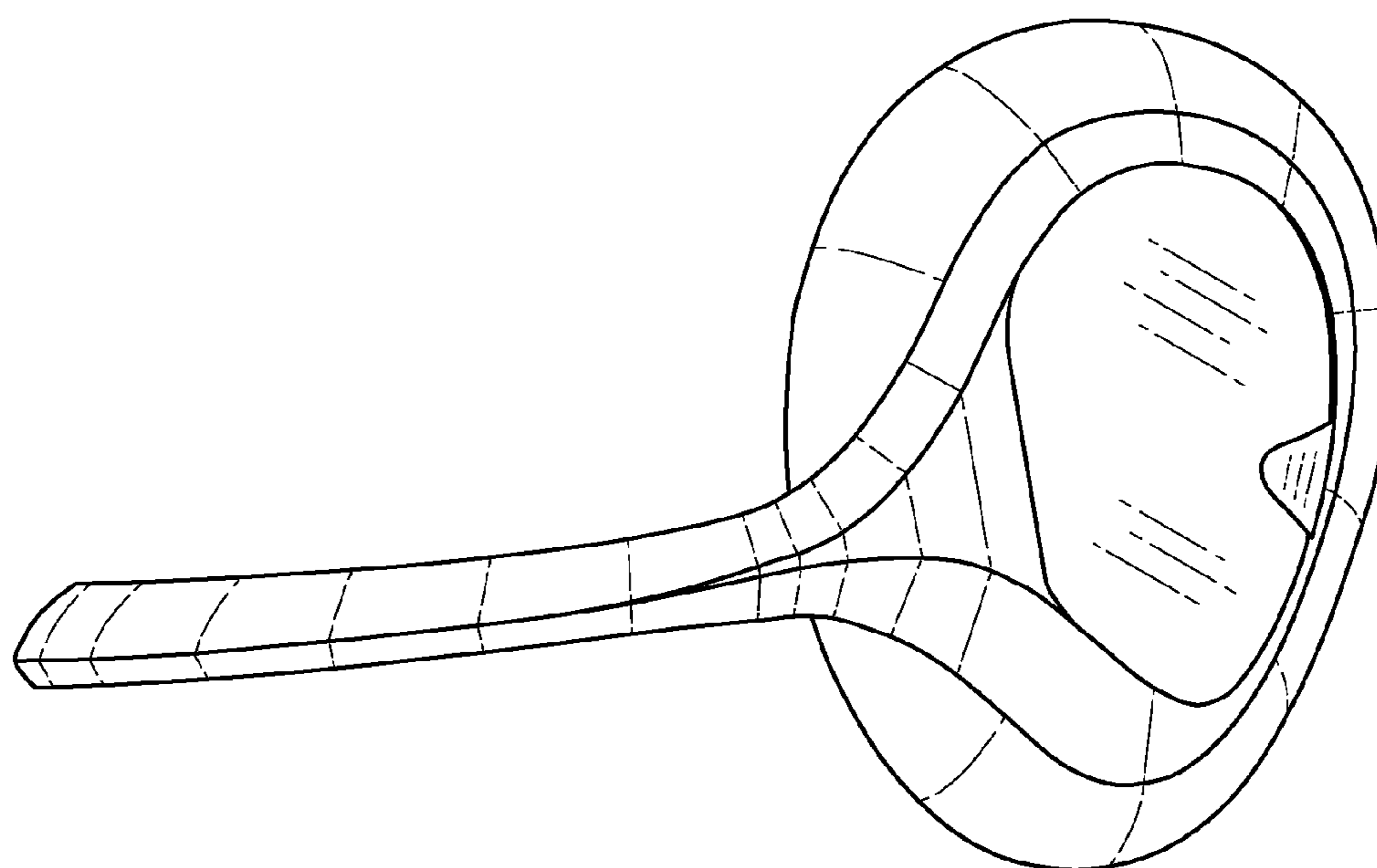

FIG. 7