

US00D669548S

(12) **United States Design Patent**  
**Titley et al.**

(10) **Patent No.:** **US D669,548 S**

(45) **Date of Patent:** **\*\* \*Oct. 23, 2012**

(54) **SURF OR PADDLE BOARD**

(75) Inventors: **Michael William Titley**, Hampshire (GB); **Peter Bladd-Symms**, West Sussex (GB)

(73) Assignee: **Envisor Limited**, Hampshire (GB)

(\*) Notice: This patent is subject to a terminal disclaimer.

(\*\*) Term: **14 Years**

(21) Appl. No.: **29/390,097**

(22) Filed: **Apr. 20, 2011**

(51) **LOC (9) Cl.** ..... **21-02**

(52) **U.S. Cl.** ..... **D21/769**

(58) **Field of Classification Search** ..... D21/769-770, D21/801, 803, 809; 114/253, 345-346; 441/35, 441/66, 40-42, 74, 75, 129-132; 472/128-129; D12/5, 6, 316

See application file for complete search history.

(56) **References Cited**

**U.S. PATENT DOCUMENTS**

3,226,739 A	1/1966	Noe	
D206,506 S	12/1966	Lambach	
3,323,154 A	6/1967	Lambach	
D209,797 S	1/1968	Looney, III et al.	
D221,262 S	7/1971	Marshall	
3,626,428 A	12/1971	Collaro	
4,028,761 A	6/1977	Taylor	
4,091,761 A	5/1978	Fehn	
4,129,911 A	12/1978	McDonald et al.	
D258,516 S	3/1981	Slingerland	
4,276,844 A	7/1981	Fremont	
4,331,340 A	5/1982	Bolen	
D265,116 S *	6/1982	Churchill	..... D21/770
D276,359 S	11/1984	Churchill	
4,507,094 A	3/1985	Hennebutte	
4,538,540 A	9/1985	Cashmere	
D296,576 S	7/1988	Gendron	

D299,846 S	2/1989	Shanelec	
D299,847 S	2/1989	Shanelec	
4,857,025 A	8/1989	Brown et al.	
D305,144 S	12/1989	Shanelec	
D305,145 S *	12/1989	Shanelec	..... D21/769
4,894,035 A	1/1990	Pia	
D315,770 S *	3/1991	Shanelec	..... D21/769
5,017,166 A	5/1991	Chang	

(Continued)

**FOREIGN PATENT DOCUMENTS**

AU 3681584 A 6/1986

(Continued)

**OTHER PUBLICATIONS**

Jim Neece. "The Bonzer." Surfer magazine. vol. 14, #3. Sep. 1973. p. 64.

*Primary Examiner* — Zenia Bennett

(74) *Attorney, Agent, or Firm* — Harness, Dickey & Pierce, P.L.C.

(57) **CLAIM**

The ornamental design for a surf or paddle board, as shown.

**DESCRIPTION**

FIG. 1 is a right front perspective view showing the bottom of a surf or paddle board in accordance with the ornamental design;

FIG. 2 is a left side elevational view thereof, the right side being a mirror image thereof;

FIG. 3 is a left front perspective view showing top of the ornamental design;

FIG. 4 is a front elevational view thereof;

FIG. 5 is a rear elevational view thereof;

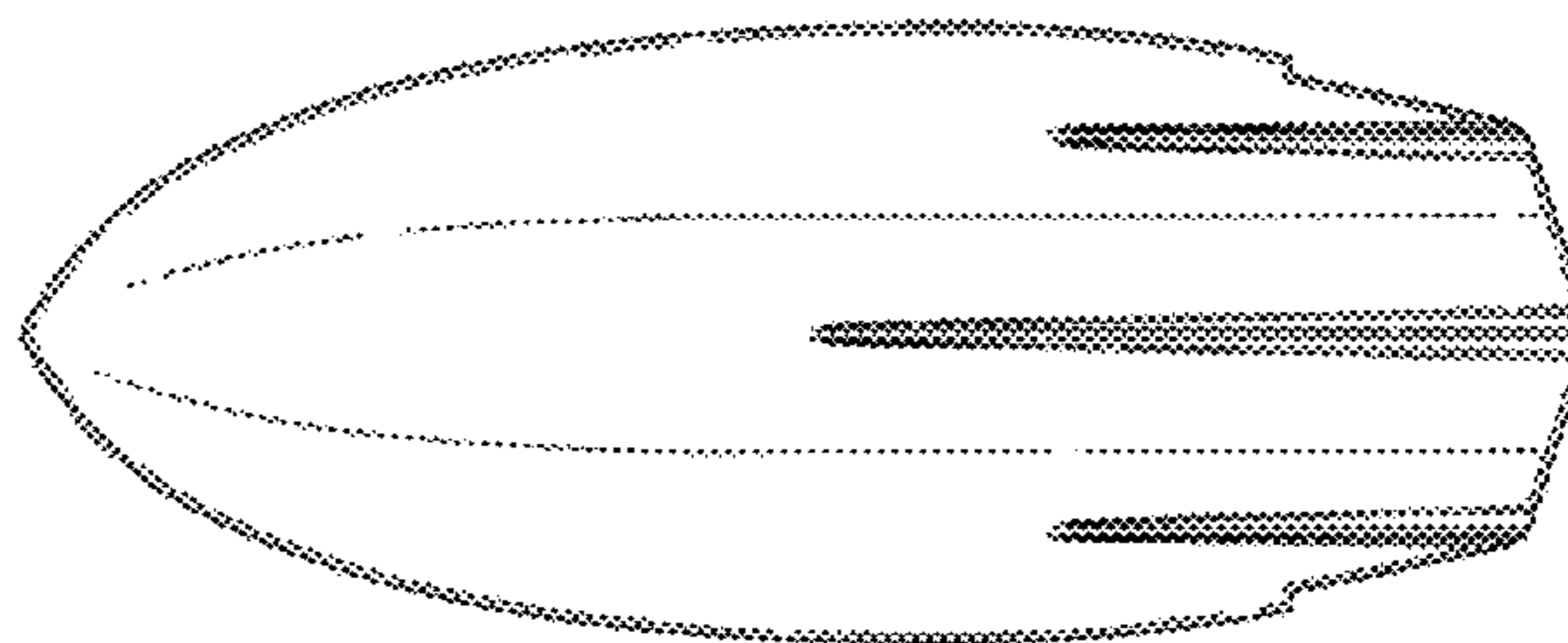
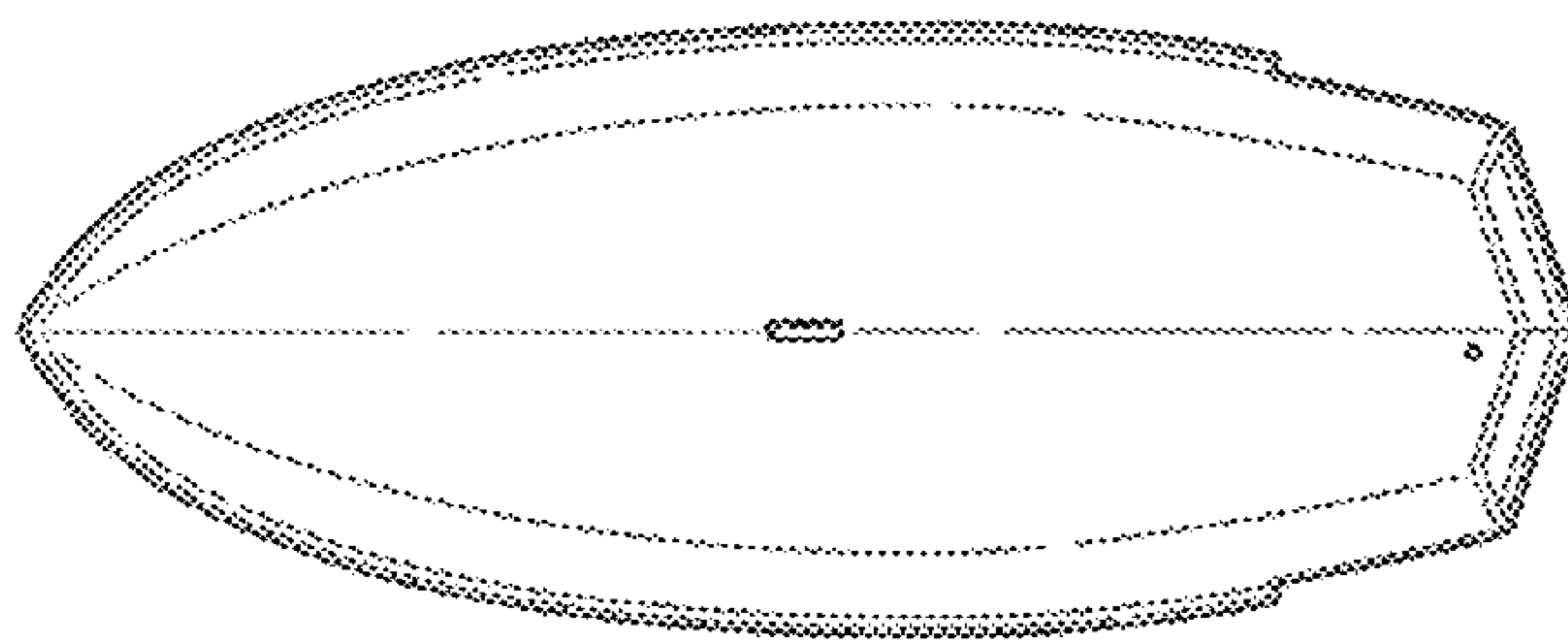
FIG. 6 is a top plan view thereof;

FIG. 7 is a bottom plan view thereof;

FIG. 8 is a right rear perspective view thereof; and,

FIG. 9 is a left rear perspective view thereof.

**1 Claim, 4 Drawing Sheets**



# US D669,548 S

Page 2

## U.S. PATENT DOCUMENTS

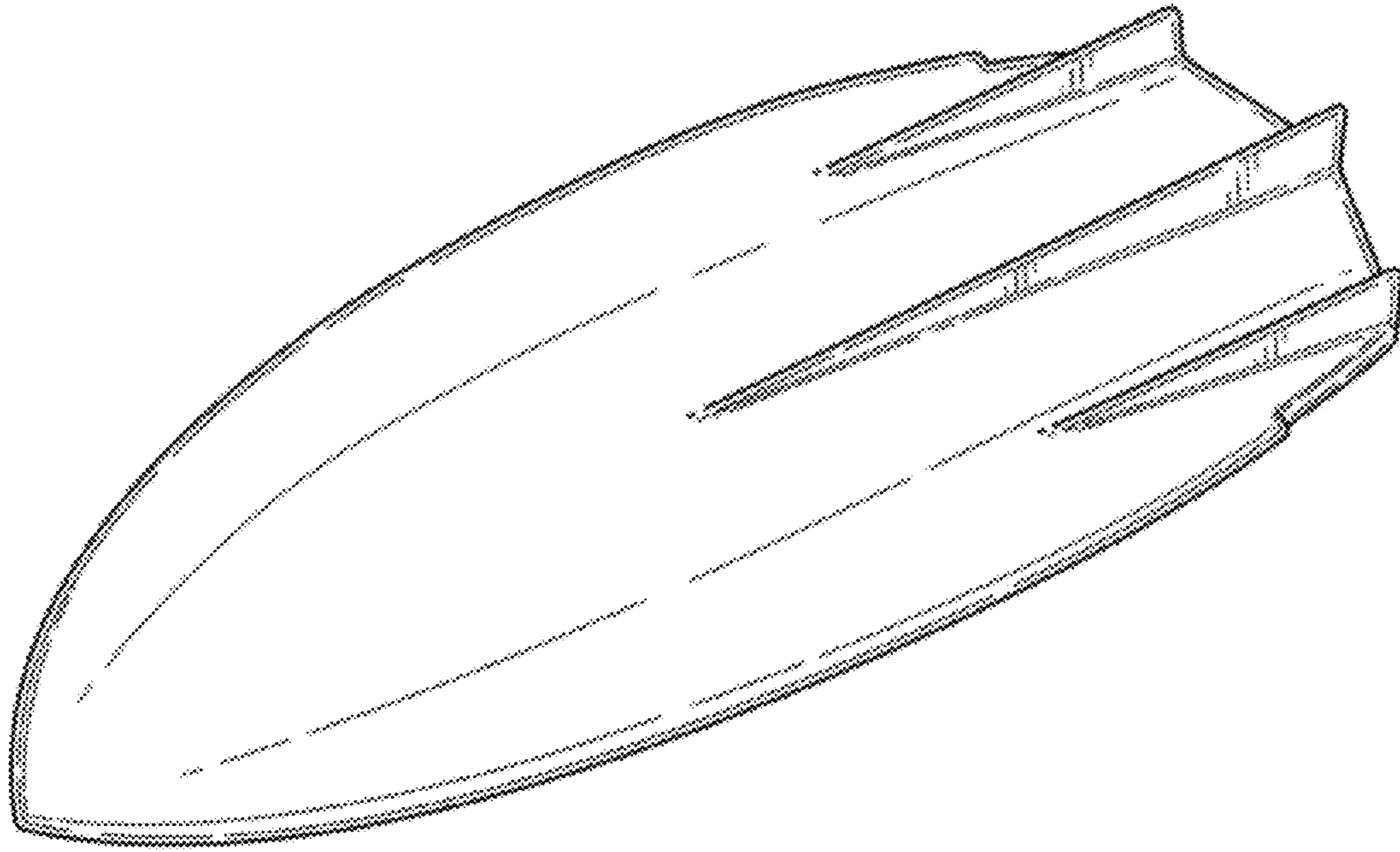
D323,691 S 2/1992 Olson  
5,127,862 A 7/1992 Pia  
D330,747 S 11/1992 Pia  
D341,171 S 11/1993 Eggert  
D345,323 S 3/1994 Stimpson  
D349,935 S 8/1994 Simonson  
D351,636 S 10/1994 Newton  
5,634,834 A 6/1997 Cole et al.  
D383,823 S 9/1997 Grimes, Jr.  
D398,693 S 9/1998 Drinkwine  
D410,515 S 6/1999 Alexander  
6,059,621 A 5/2000 Vogel  
D428,459 S 7/2000 Broz et al.  
6,106,347 A 8/2000 Harness  
D461,516 S 8/2002 Chen  
D503,763 S 4/2005 Morgan  
6,955,577 B1 10/2005 Hall  
7,074,098 B1 7/2006 Acosta, Jr.  
D527,781 S 9/2006 Walden  
7,347,756 B1 3/2008 Candler  
7,524,225 B1 4/2009 Richenberg et al.  
D604,785 S 11/2009 Meyerhoffer  
D607,524 S 1/2010 Marciano  
7,685,959 B1 3/2010 Sanders  
2006/0014449 A1 1/2006 French  
2006/0057912 A1 3/2006 Brind  
2006/0276087 A1 12/2006 Conner

2007/0173145 A1 7/2007 Koelling et al.  
2008/0032575 A1 2/2008 Wyrsta et al.  
2008/0287018 A1 11/2008 Johnson  
2009/0286433 A1 11/2009 Watanabe  
2010/0075555 A1 3/2010 Yeh et al.

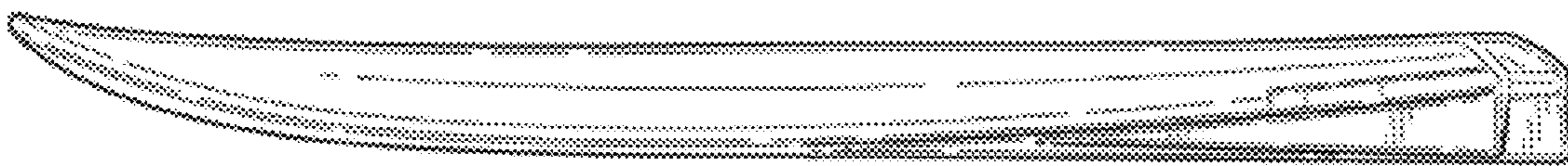
## FOREIGN PATENT DOCUMENTS

AU 609728 B2 5/1991  
AU 2001100204 A4 8/2001  
AU 2003204628 A1 1/2005  
CN 2811160 Y 8/2006  
CN 1970121 A 5/2007  
CN 101088858 A 12/2007  
EP 0087777 A1 9/1983  
FR 2636590 A1 3/1990  
FR 2777470 A1 10/1999  
GB 1199658 A 7/1970  
GB 2167016 A 5/1986  
GB 2436690 A 10/2007  
JP 2000053081 A 2/2000  
JP 2006247366 A 9/2006  
WO WO-9003306 A2 4/1990  
WO WO-9727100 A1 7/1997  
WO WO-2004039663 A1 5/2004  
WO WO-2005028294 A1 3/2005  
WO WO-2006092020 A1 9/2006  
WO WO-200813806 A1 11/2008

\* cited by examiner

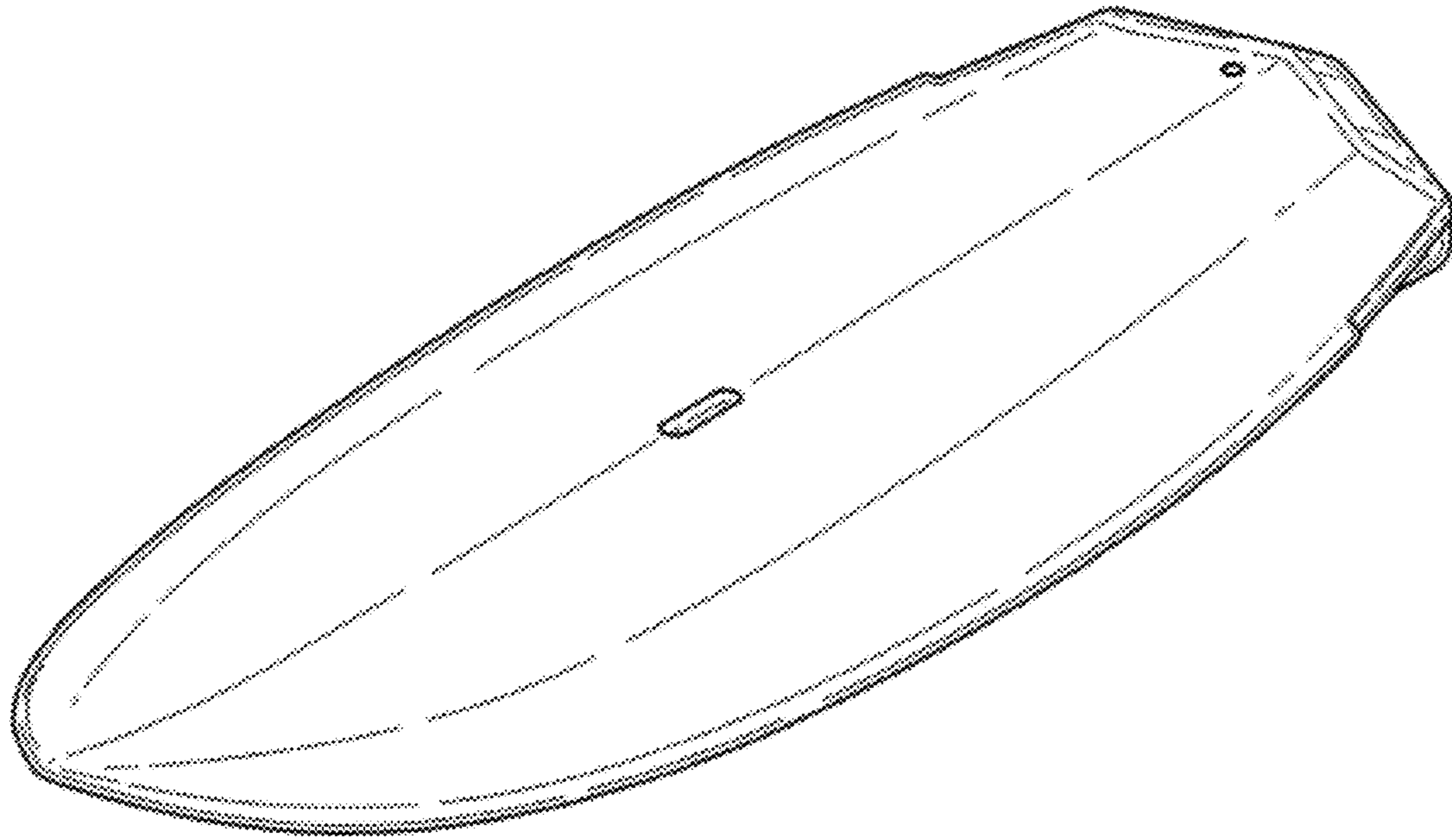


**FIG. 1**



**FIG. 2**

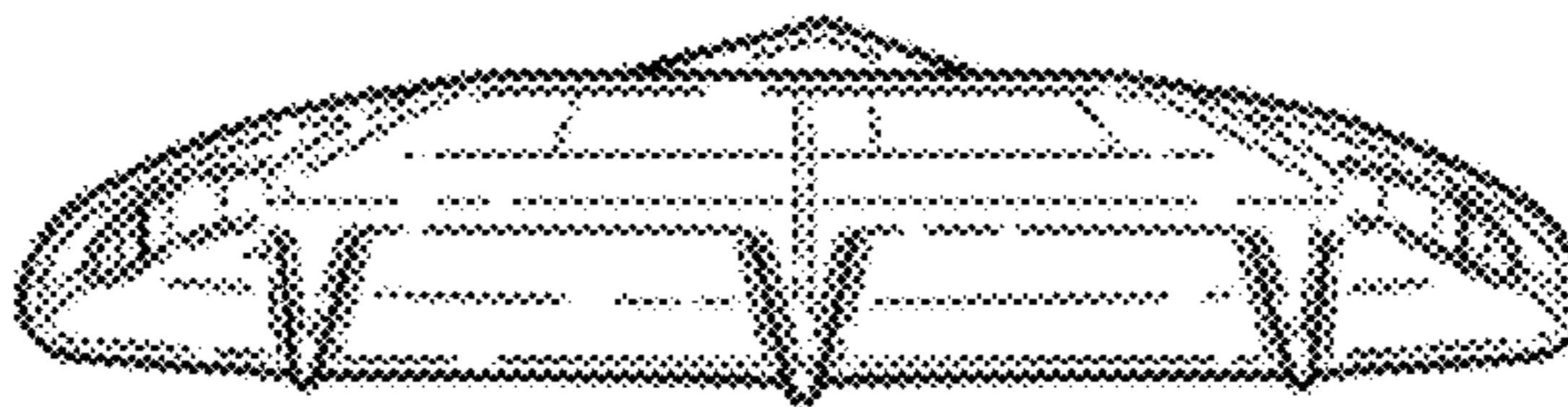




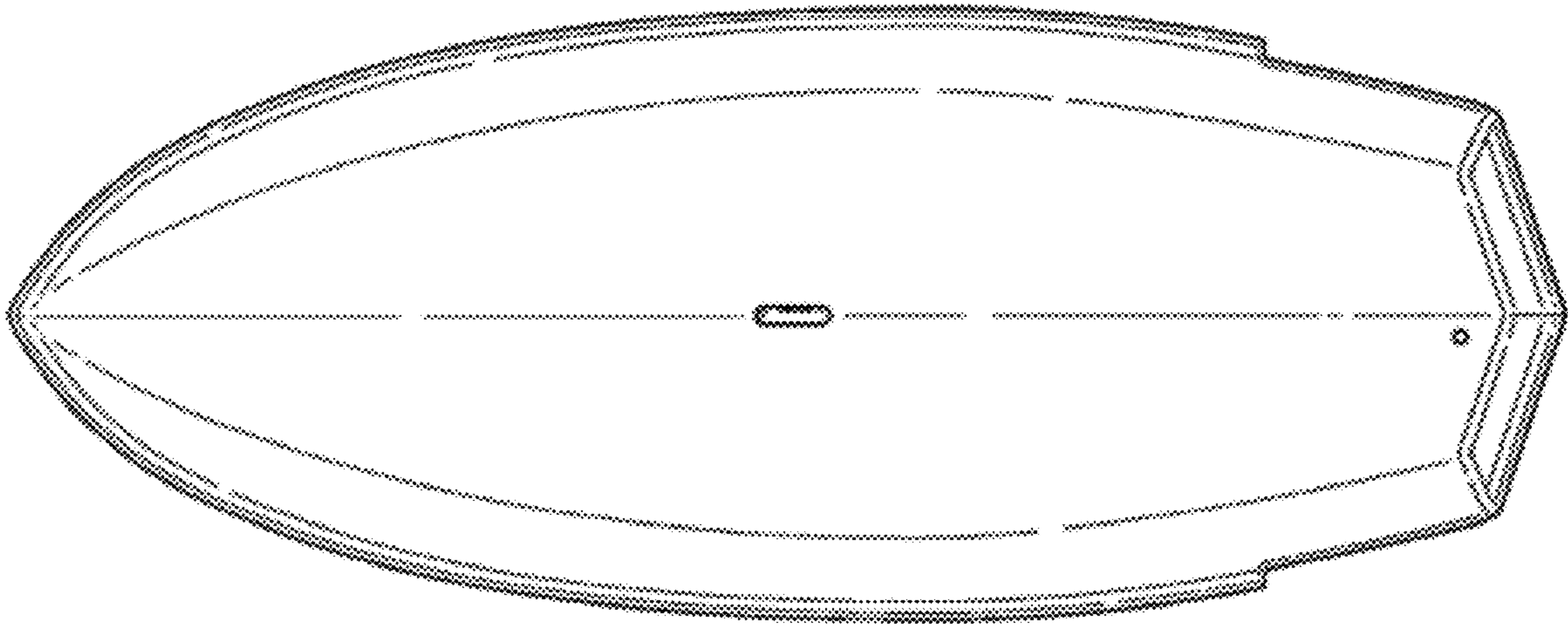
**FIG. 3**



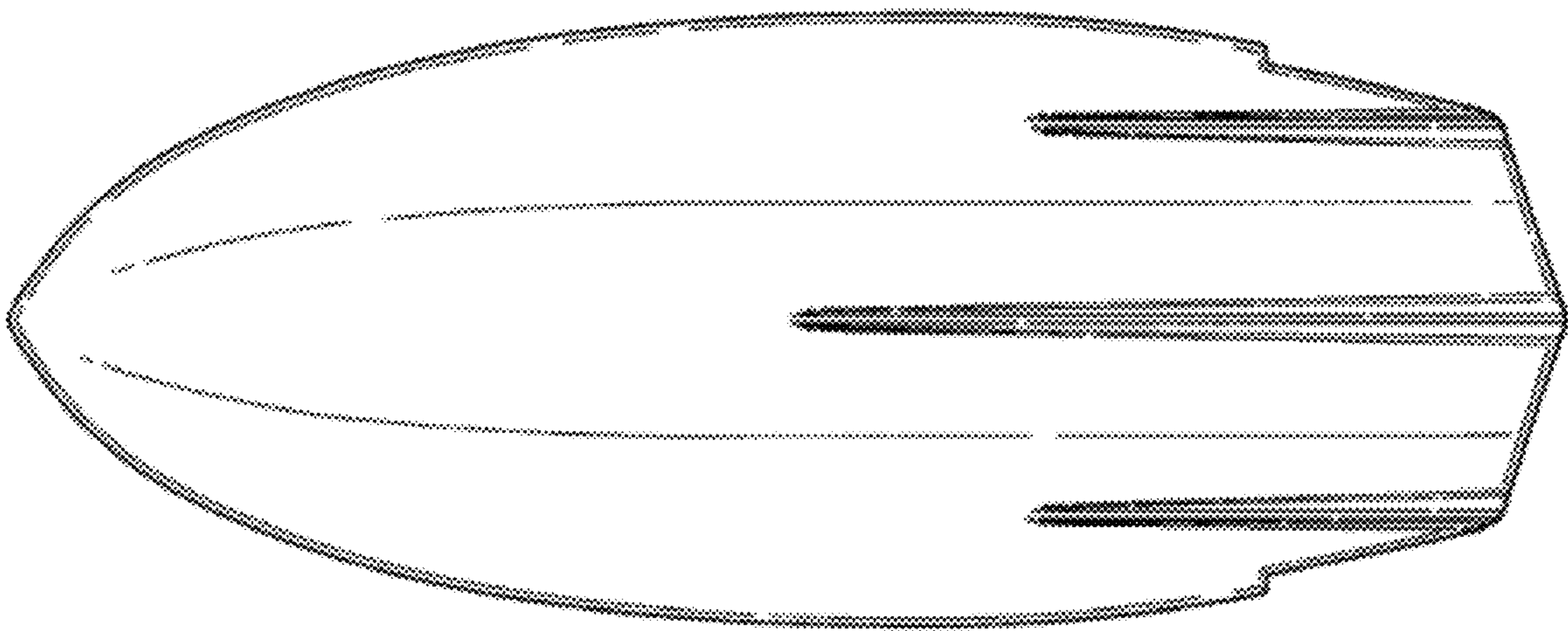
**FIG. 4**



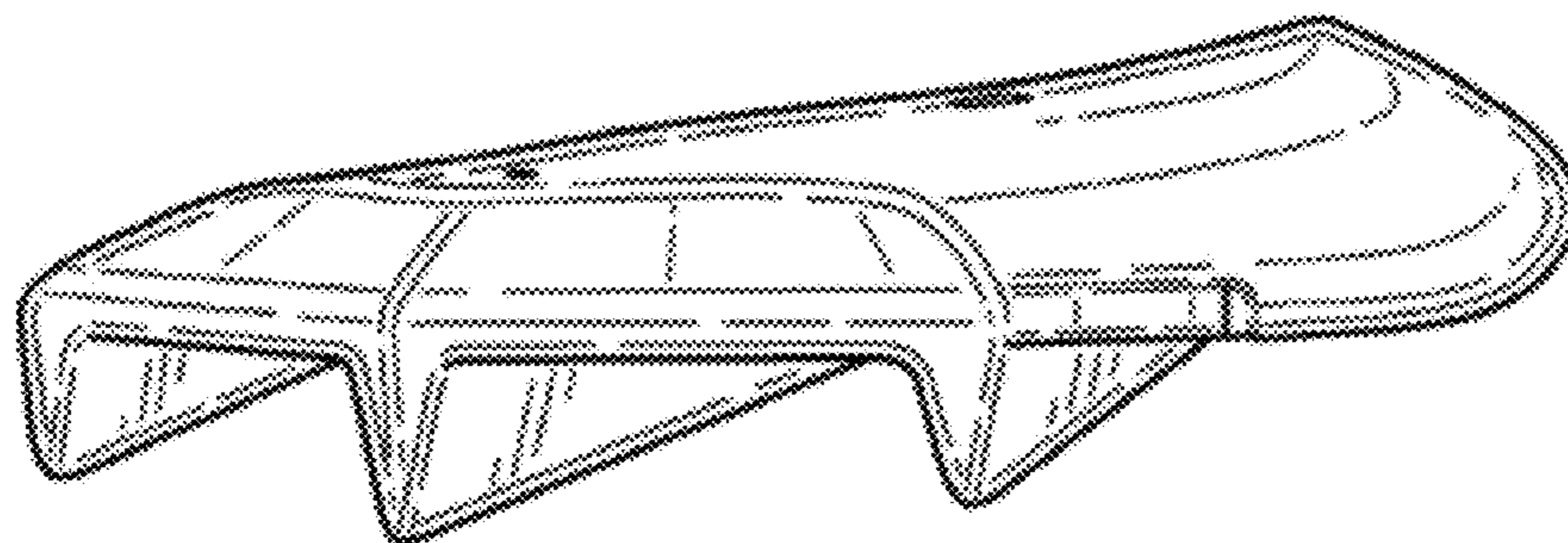
**FIG. 5**



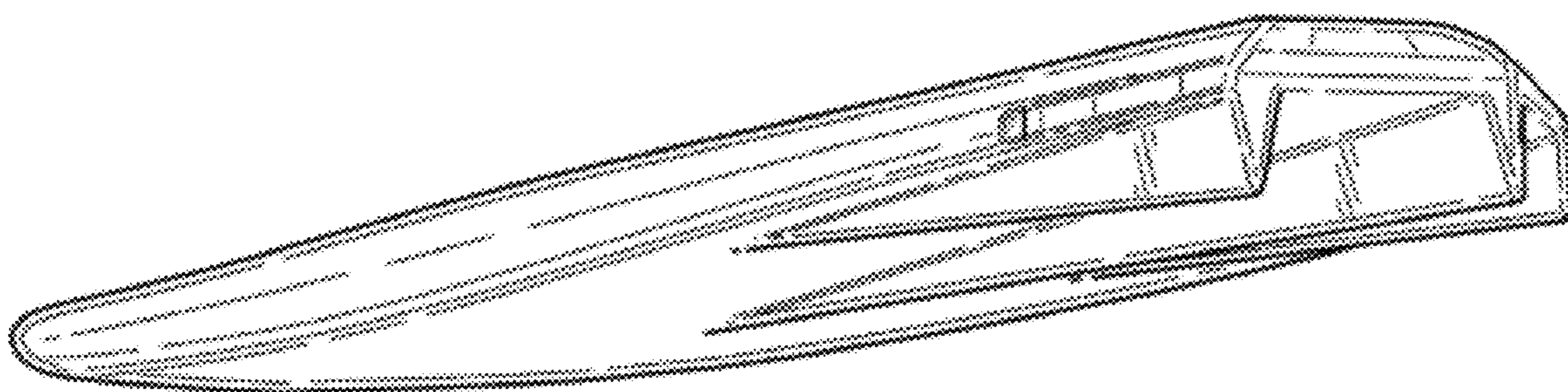
**FIG. 6**



**FIG. 7**



**FIG. 8**



**FIG. 9**

UNITED STATES PATENT AND TRADEMARK OFFICE  
**CERTIFICATE OF CORRECTION**

PATENT NO. : D669,548 S  
APPLICATION NO. : 29/390097  
DATED : October 23, 2012  
INVENTOR(S) : Michael William Titley et al.

Page 1 of 1

It is certified that error appears in the above-identified patent and that said Letters Patent is hereby corrected as shown below:

Title Page Item (30) – Foreign Application Priority Data has been omitted.  
Should be -- October 21, 2010 (EM).....0001241624-0003 --.

Signed and Sealed this  
Fifth Day of February, 2013



Teresa Stanek Rea  
*Acting Director of the United States Patent and Trademark Office*