



US00D669511S

(12) **United States Design Patent**
Boehm et al.

(10) **Patent No.:** **US D669,511 S**
(45) **Date of Patent:** **** Oct. 23, 2012**

- (54) **OPTICAL FILTER WHEEL FOR A MICROSCOPE**
- (75) Inventors: **Ingo Boehm**, Heidelberg (DE);
Dirk-Oliver Fehrer, Bad Schoenborn (DE)
- (73) Assignee: **Leica Microsystems CMS GmbH**,
Wetzlar (DE)
- (**) Term: **14 Years**
- (21) Appl. No.: **29/402,400**
- (22) Filed: **Sep. 23, 2011**
- (30) **Foreign Application Priority Data**
Mar. 25, 2011 (EM) 001841388
- (51) **LOC (9) Cl.** **16-01**
- (52) **U.S. Cl.** **D16/131; D16/136**
- (58) **Field of Classification Search** D16/135,
D16/130, 136, 134, 131, 239; 359/368, 821,
359/672-676, 822, 281; D24/227, 232; 356/244;
250/201.1
See application file for complete search history.

(56) **References Cited**

U.S. PATENT DOCUMENTS

905,633	A *	12/1908	Bausch	359/821
1,042,346	A *	10/1912	Henle	359/421
1,817,642	A *	8/1931	Ott	359/821
2,205,179	A *	6/1940	Schultz	359/889
D150,102	S *	6/1948	Weinstein	D16/136
2,761,558	A *	9/1956	McLean, Jr.	206/456
D198,142	S *	5/1964	Armbruster	D16/131
3,202,047	A *	8/1965	Lawler	359/384
D210,253	S *	2/1968	Dine	D16/239
3,418,908	A *	12/1968	Land	396/107
3,479,512	A *	11/1969	Weissenberg	250/201.1
D219,396	S *	12/1970	Bodkins	D26/124
D242,790	S *	12/1976	Armbruster	D16/131
4,066,330	A *	1/1978	Jones	359/503
D247,245	S *	2/1978	Armbruster	D16/131
D254,311	S *	2/1980	Morgan et al.	D16/131
D256,470	S *	8/1980	Gordon	D16/131
4,486,078	A *	12/1984	Hashimoto et al.	359/381
D304,592	S *	11/1989	Hoogesteger	D16/131
5,290,705	A *	3/1994	Davis	436/164
5,648,869	A *	7/1997	Ikoh	359/368
5,842,055	A *	11/1998	Tamura	396/72
6,717,726	B2 *	4/2004	Boehm et al.	359/388

6,754,008	B1 *	6/2004	Wallerstein et al.	359/672
7,005,622	B2 *	2/2006	Boehm et al.	250/201.3
7,057,162	B2 *	6/2006	Rentzsch	250/231.14
7,372,625	B2 *	5/2008	Jagemann	359/368
7,428,043	B2 *	9/2008	Boehm et al.	356/218
7,495,852	B2 *	2/2009	Gutierrez	359/821
7,593,173	B2 *	9/2009	Harada et al.	359/821
7,600,926	B2 *	10/2009	Fehrer et al.	385/90
D660,336	S *	5/2012	Fehrer et al.	D16/131

* cited by examiner

Primary Examiner — Paula Greene

(74) *Attorney, Agent, or Firm* — Crowell & Moring LLP

(57) **CLAIM**

The ornamental design for an optical filter wheel for a microscope, as shown and described.

DESCRIPTION

FIG. 1 is an elevated, front perspective view of a first embodiment of an optical filter wheel for a microscope according to our design;

FIG. 2 is a top view thereof;

FIG. 3 is a bottom view thereof;

FIG. 4 is a right side view thereof;

FIG. 5 is a front view thereof;

FIG. 6 is a left side view thereof; and

FIG. 7 is a rear view thereof.

FIG. 8 is an elevated, front perspective view of a second embodiment of the optical filter wheel for a microscope according to our design;

FIG. 9 is a top view thereof;

FIG. 10 is a bottom view thereof;

FIG. 11 is a right side view thereof;

FIG. 12 is a front view thereof;

FIG. 13 is a left side view thereof; and

FIG. 14 is a rear view thereof.

FIG. 15 is an elevated, front perspective view of a third embodiment of the optical filter wheel for a microscope according to our design;

FIG. 16 is a top view thereof;

FIG. 17 is a bottom view thereof;

FIG. 18 is a right side view thereof;

FIG. 19 is a front view thereof;

FIG. 20 is a left side view thereof; and,

FIG. 21 is a rear view thereof.

1 Claim, 12 Drawing Sheets

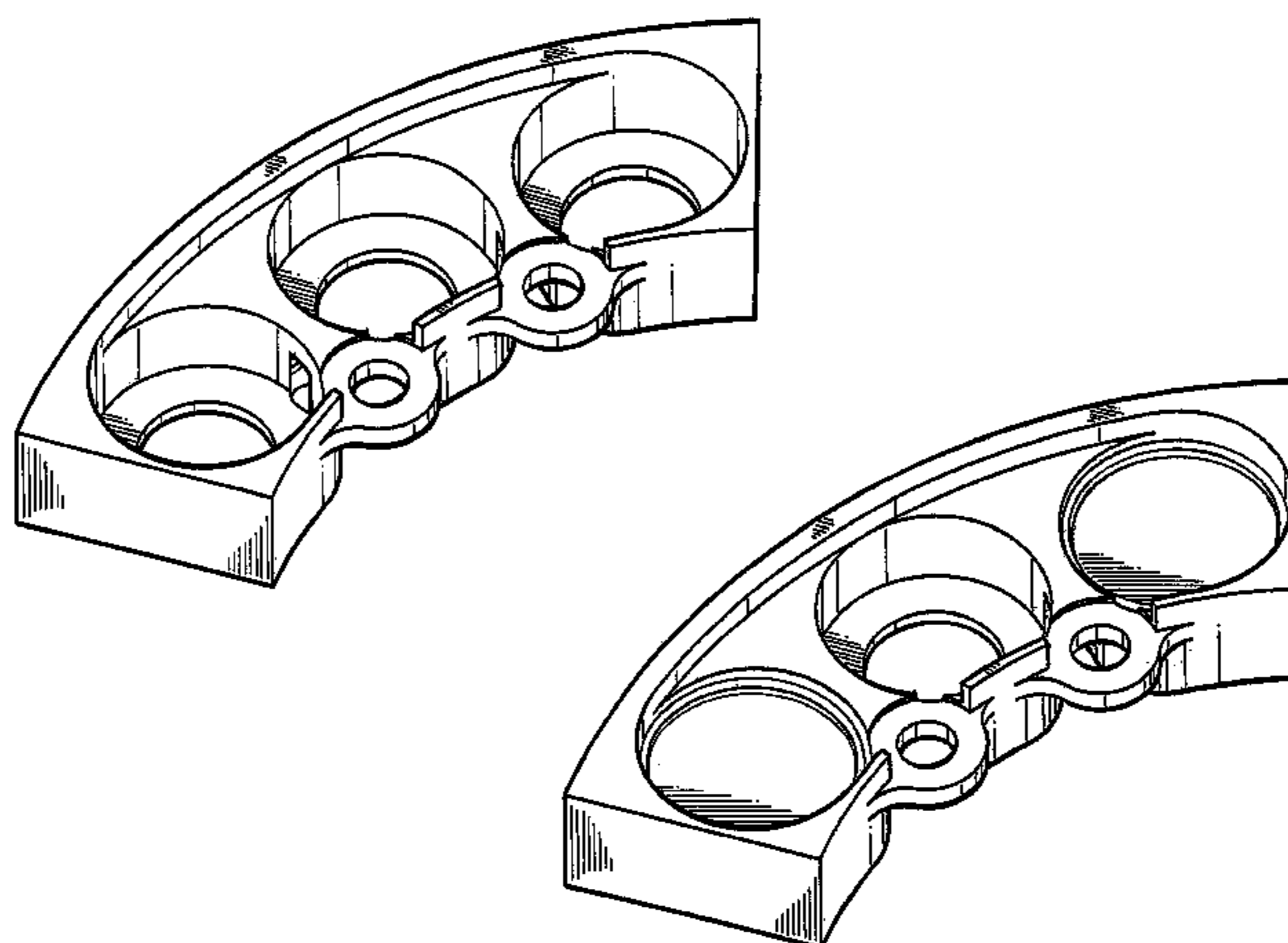

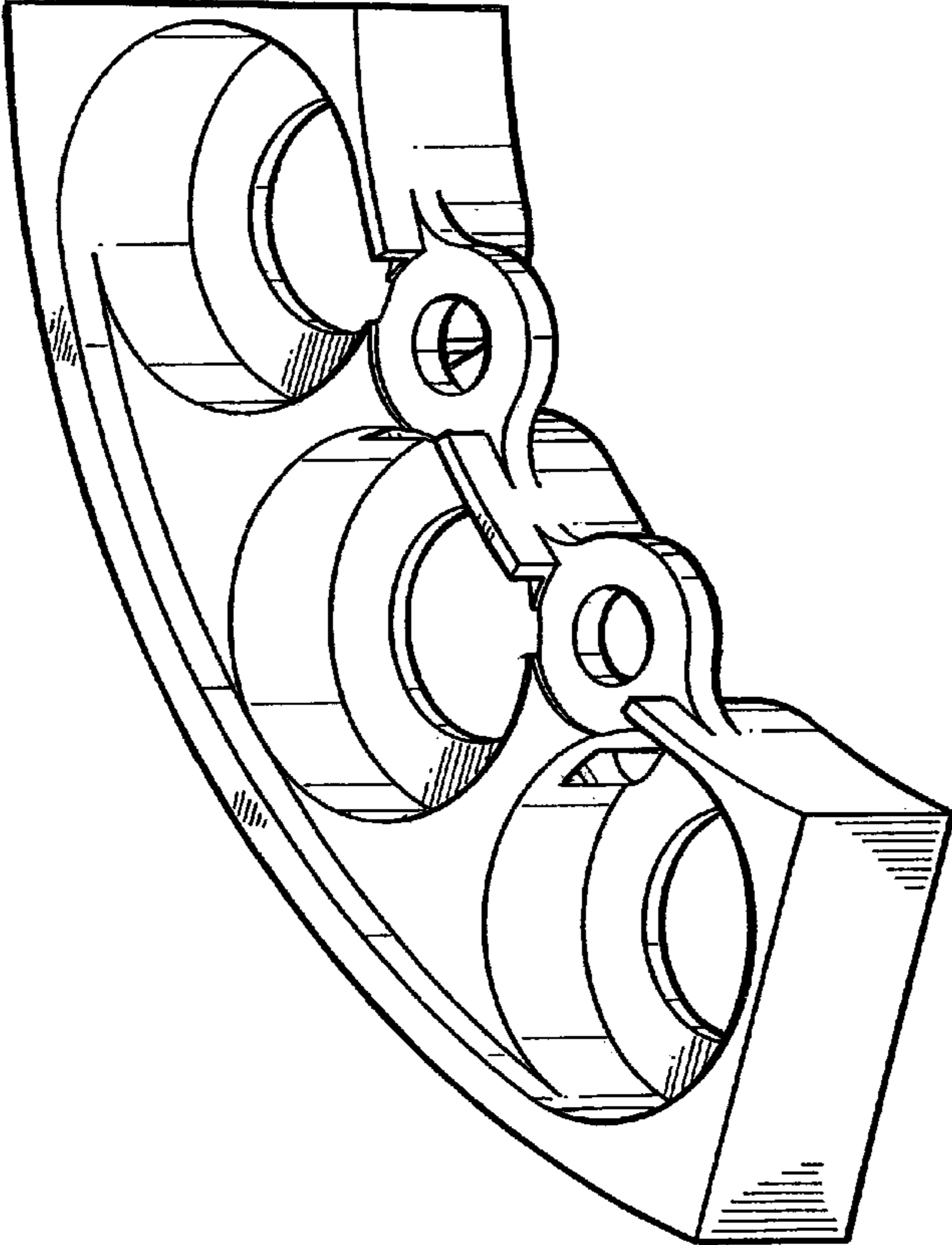

FIG. 1

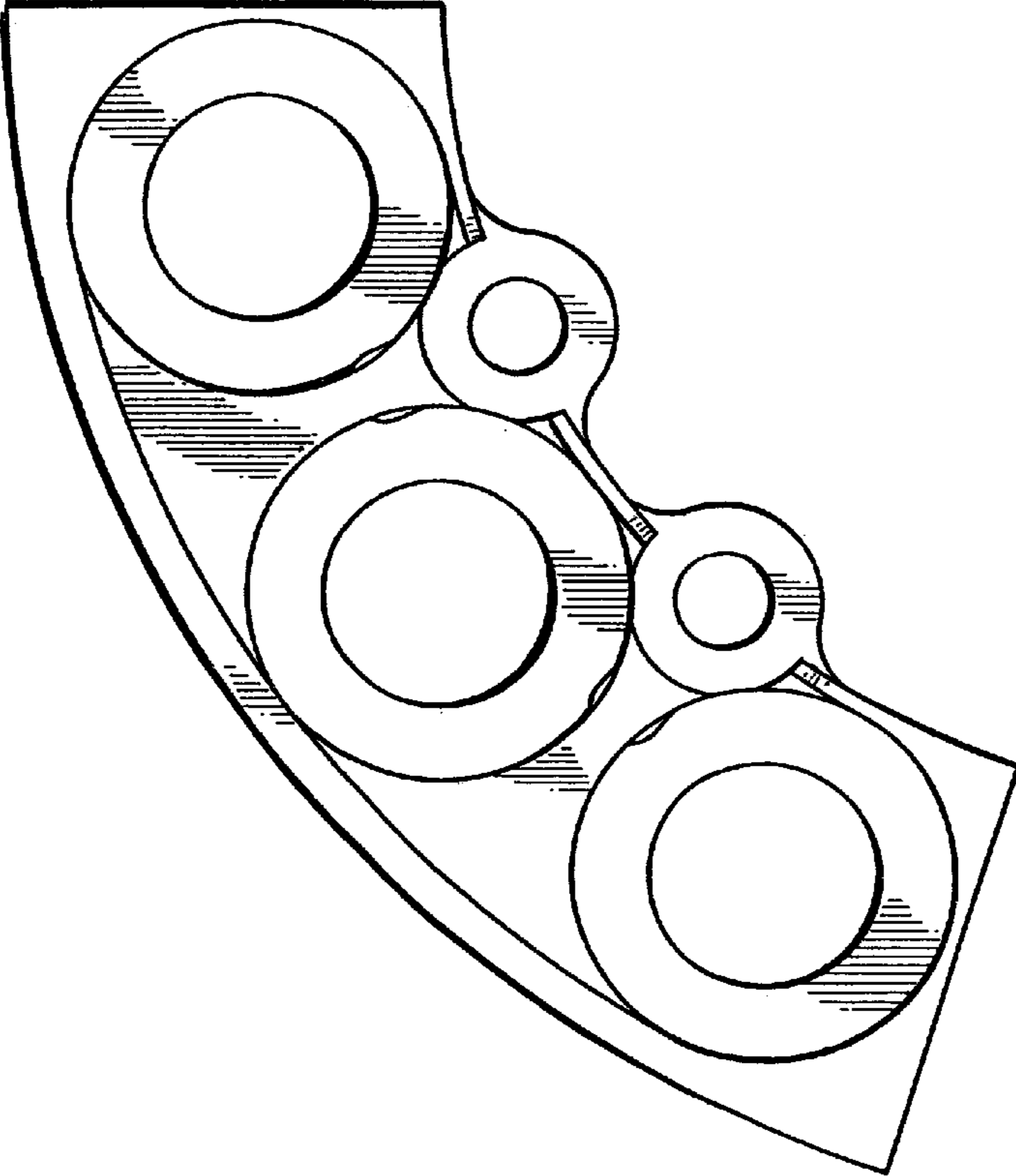

FIG. 2

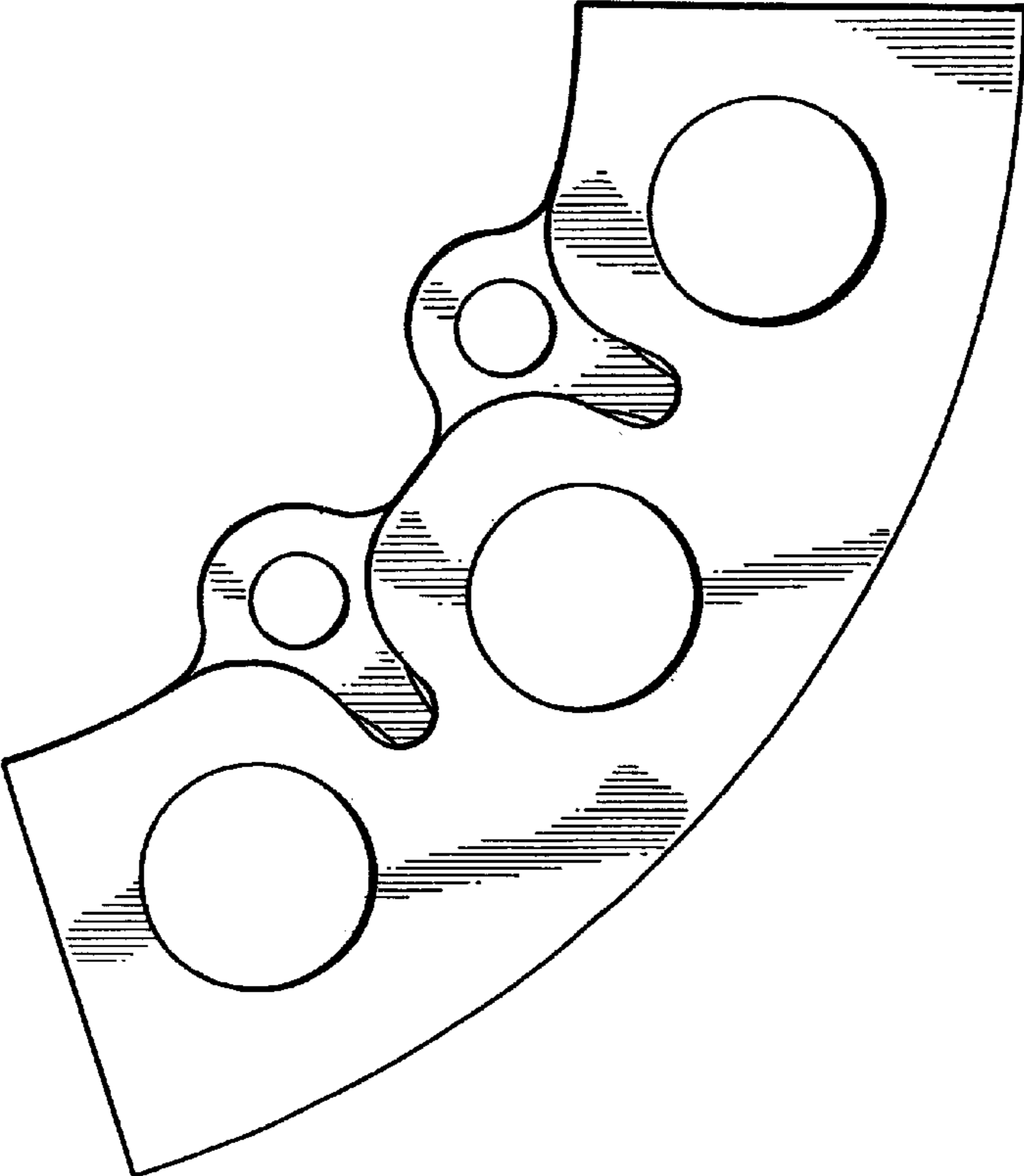

FIG. 3

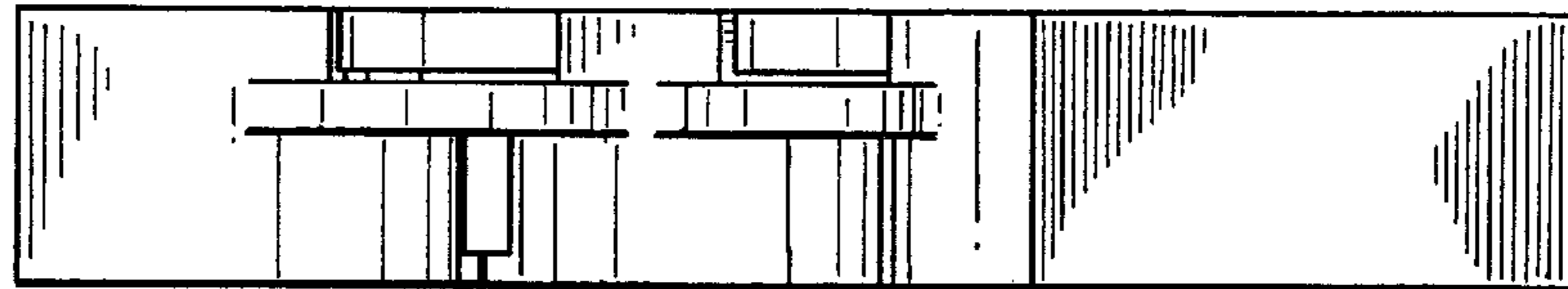

FIG. 4

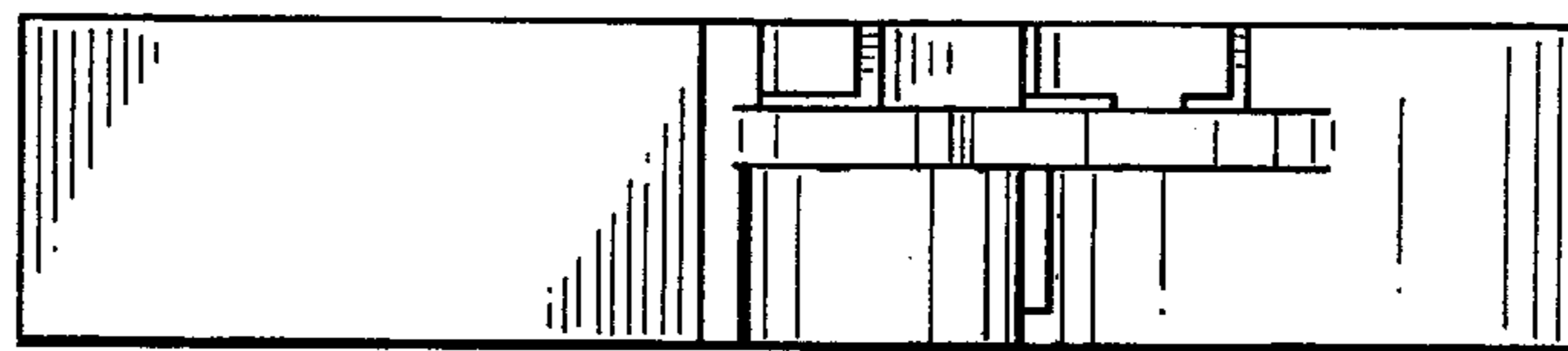

FIG. 5

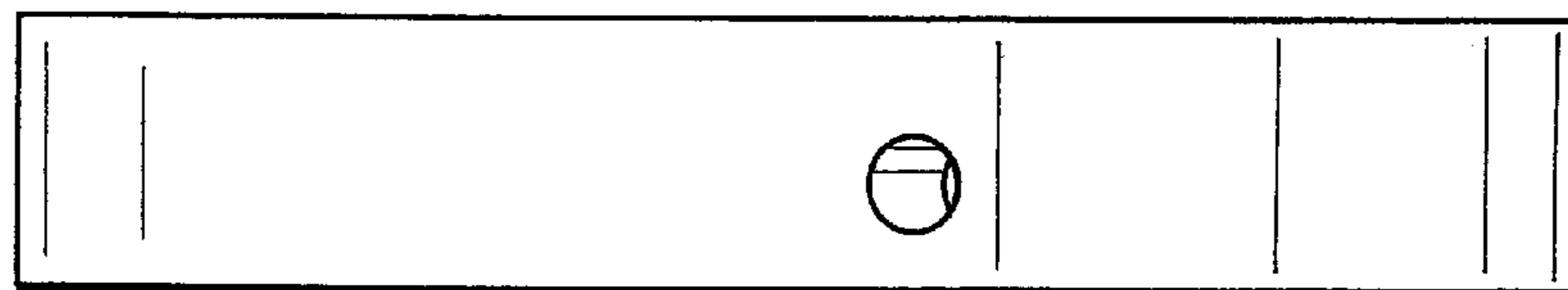

FIG. 6



FIG. 7

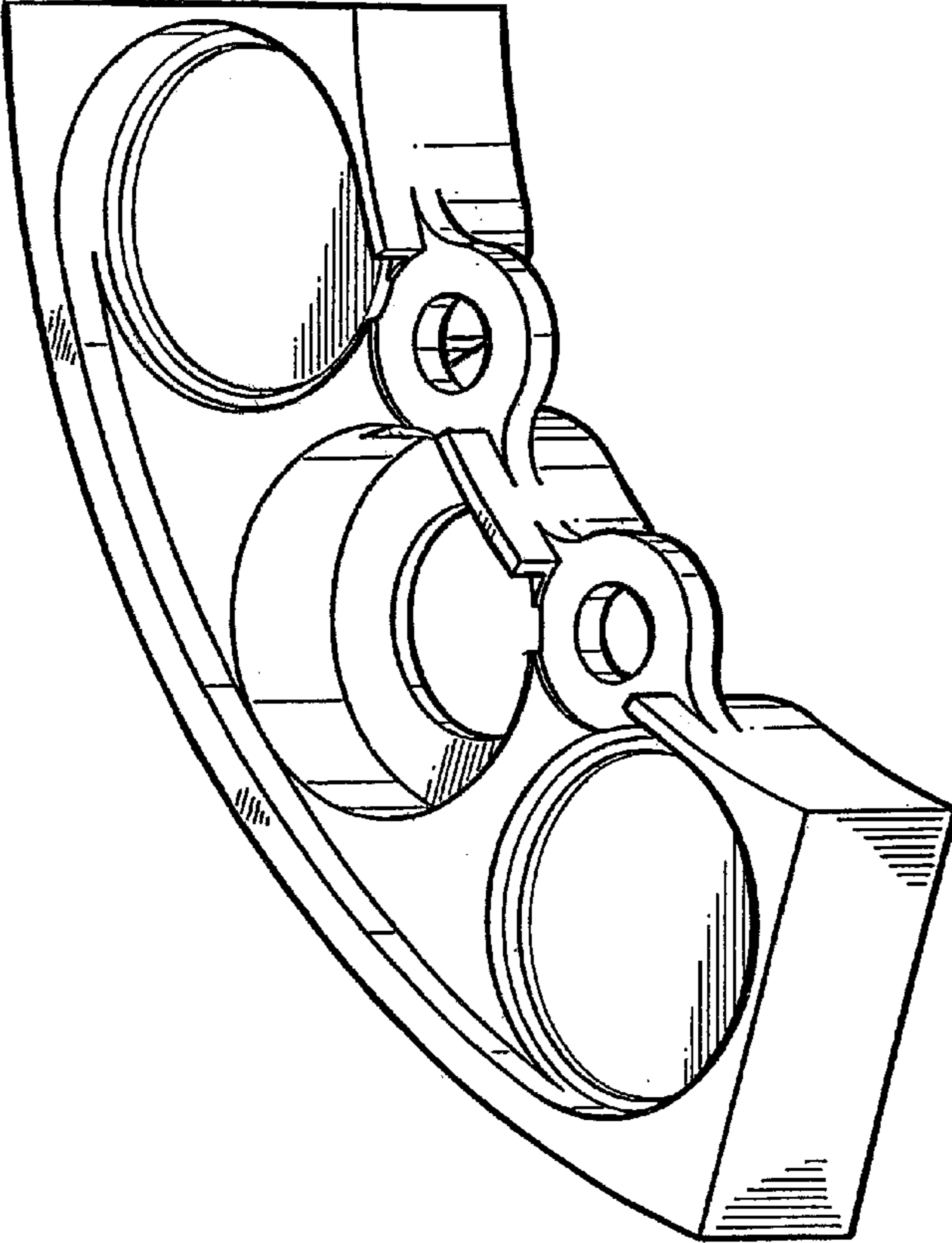

FIG. 8

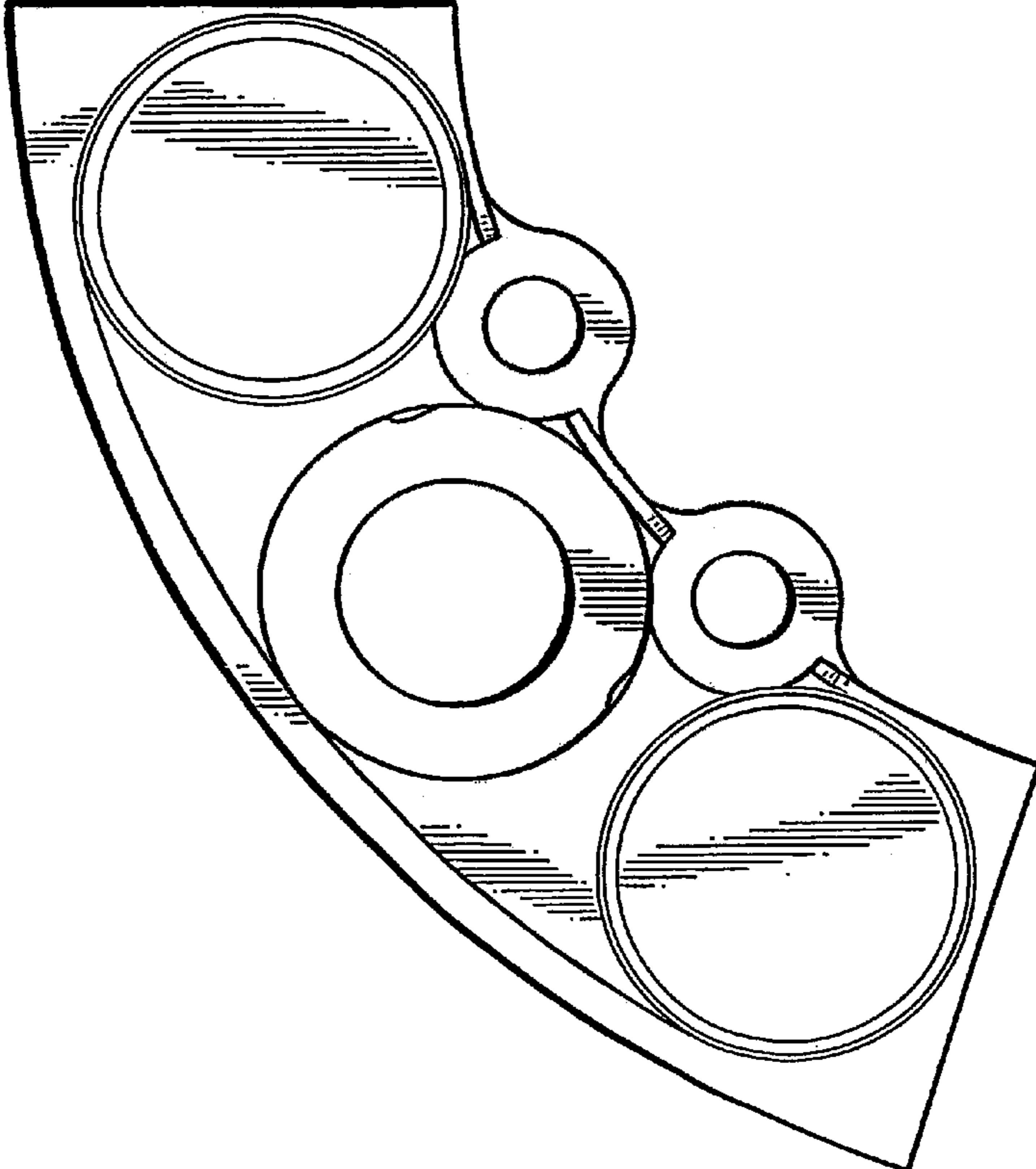

FIG. 9

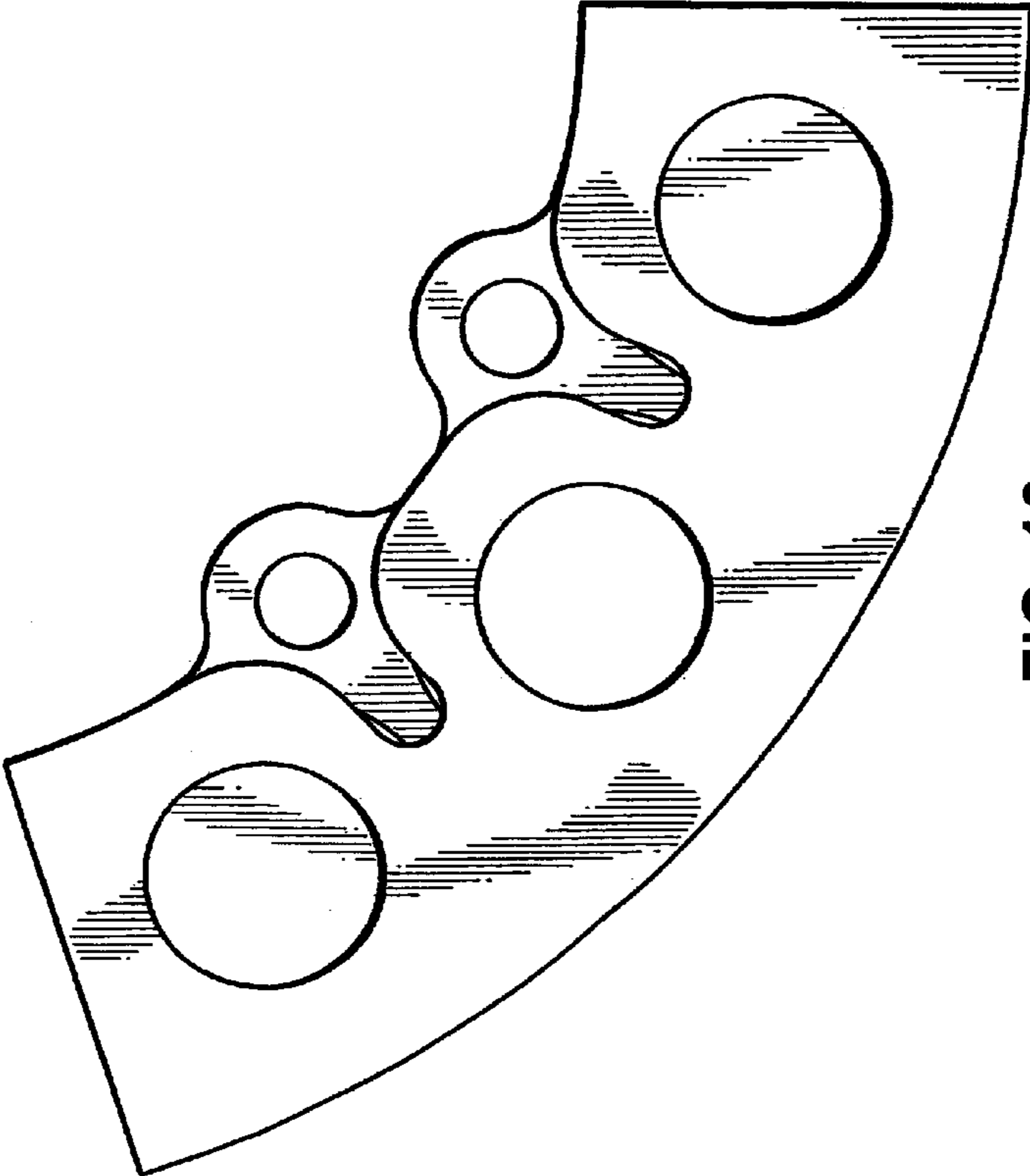

FIG. 10

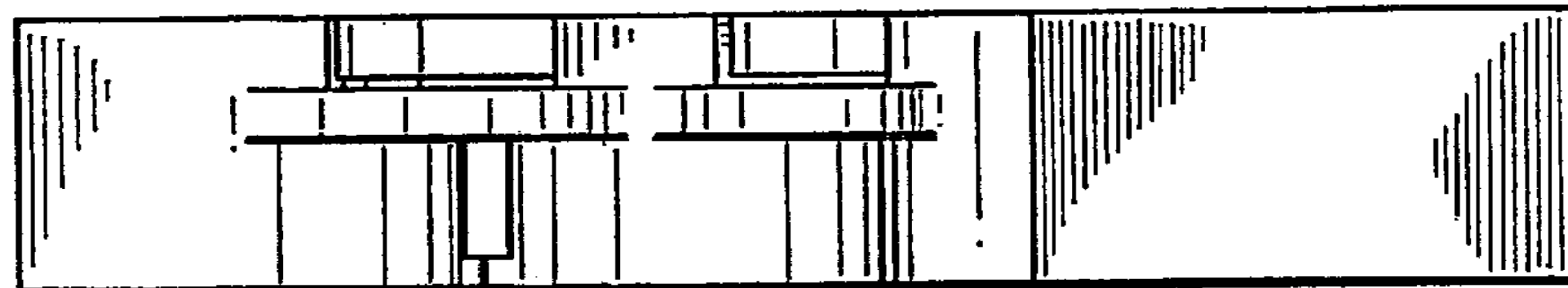

FIG. 11

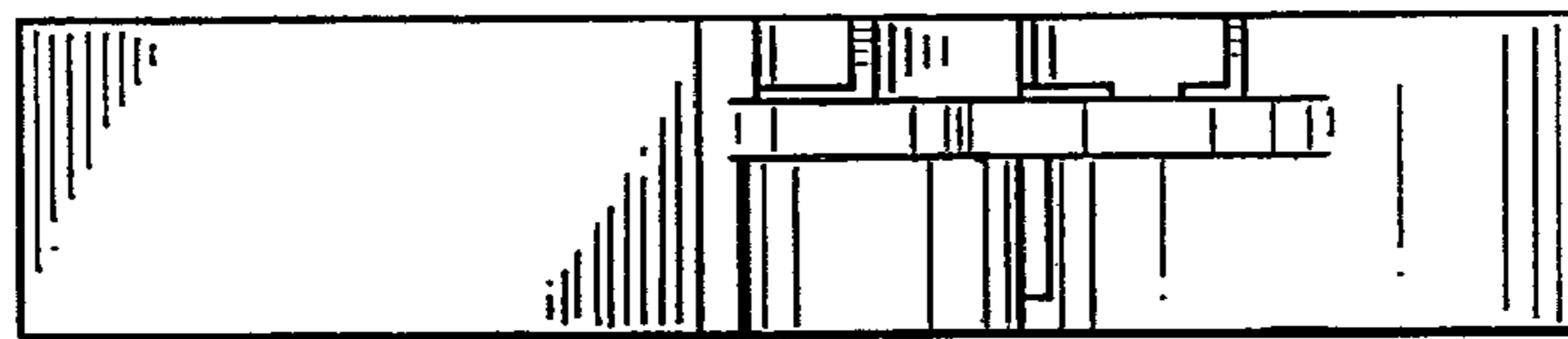

FIG. 12

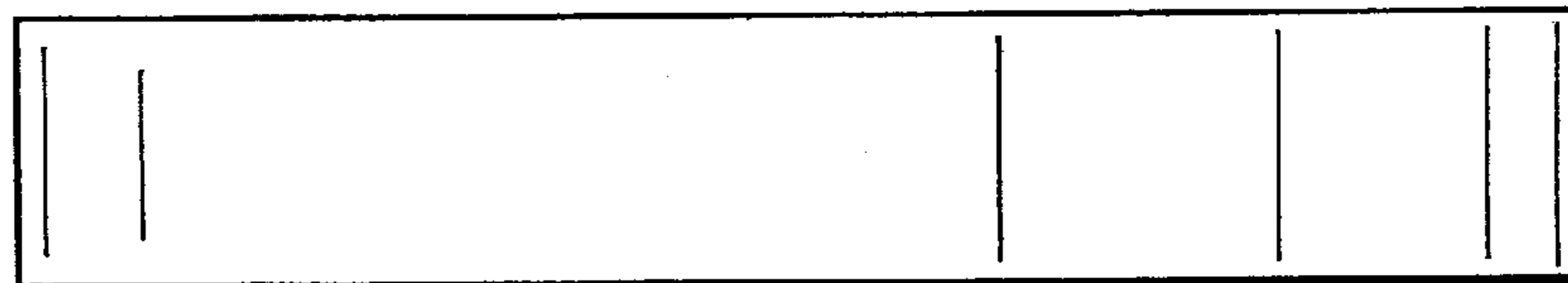

FIG. 13

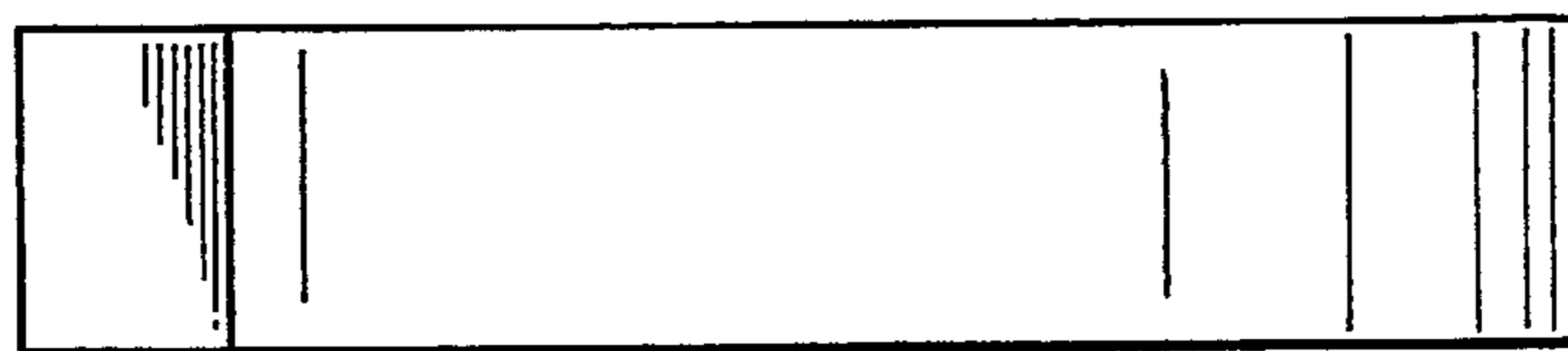

FIG. 14

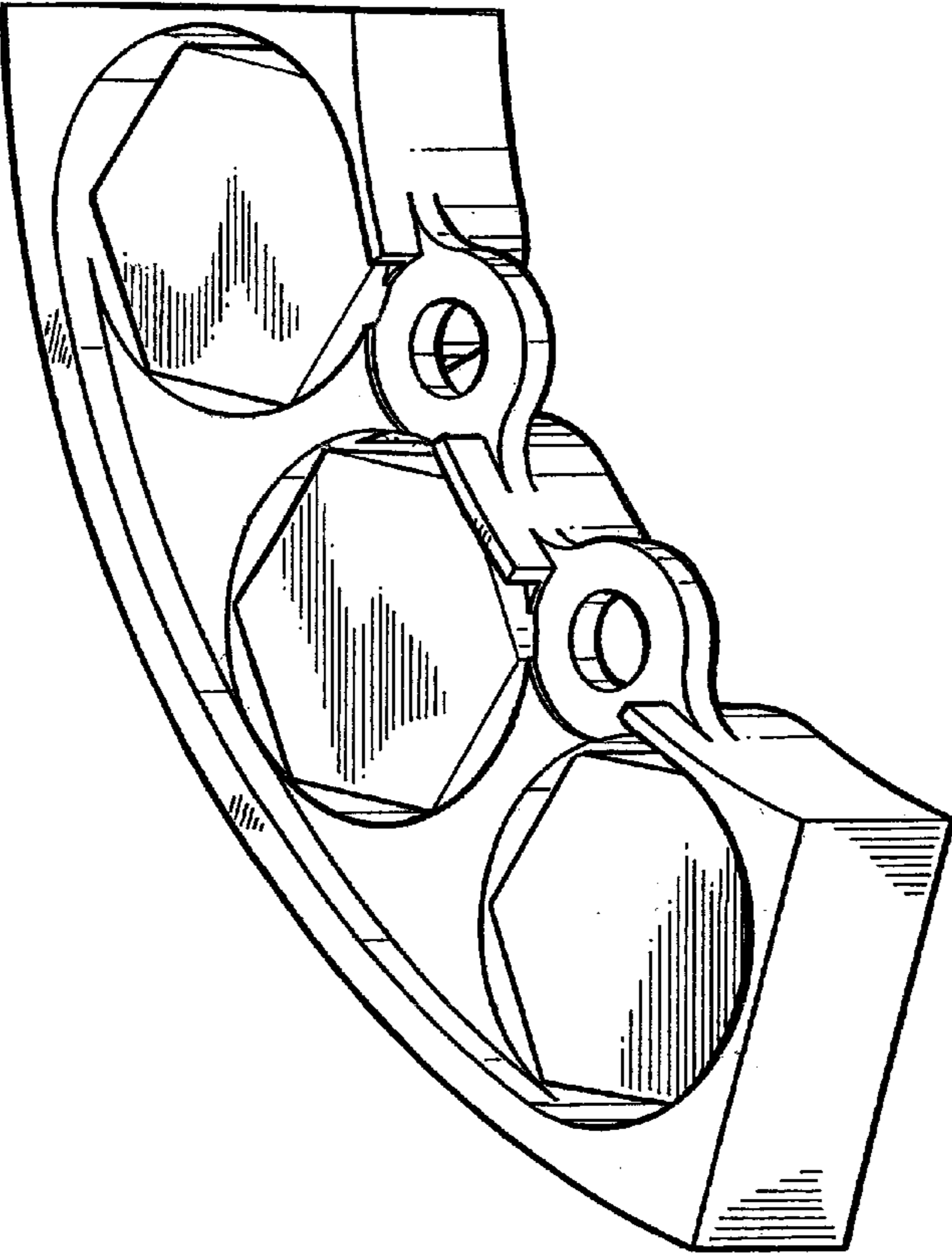

FIG. 15

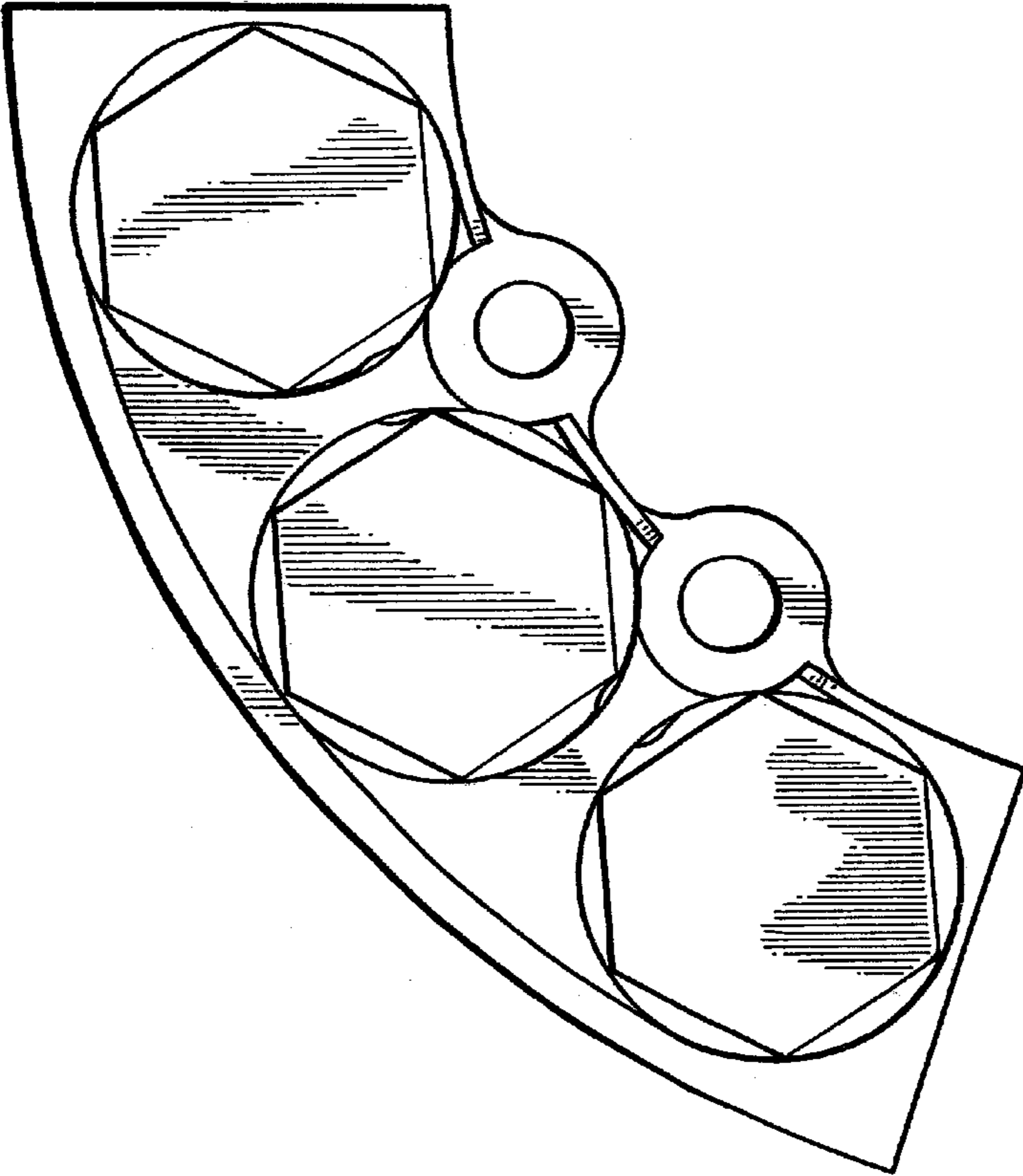

FIG. 16

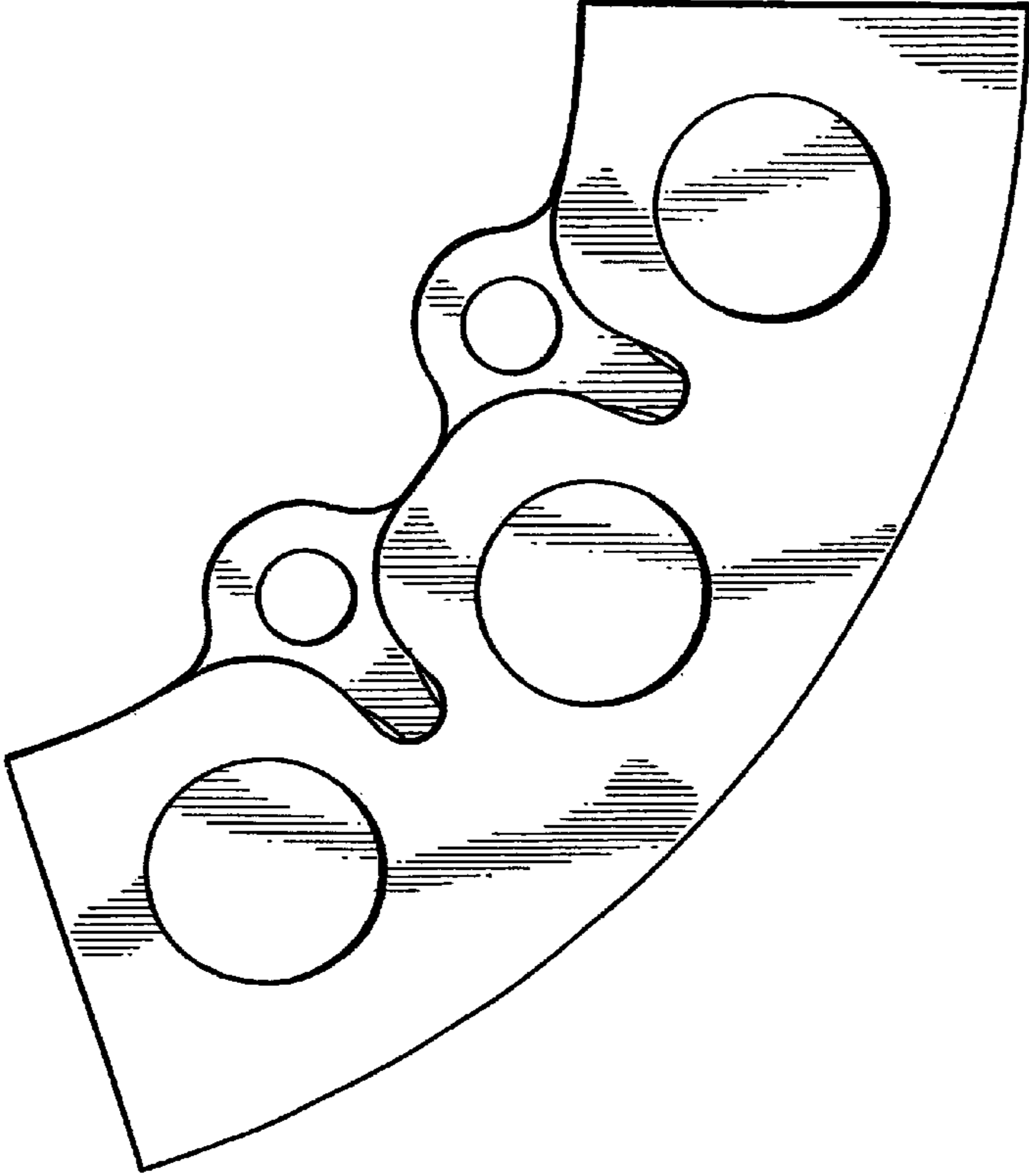

FIG. 17

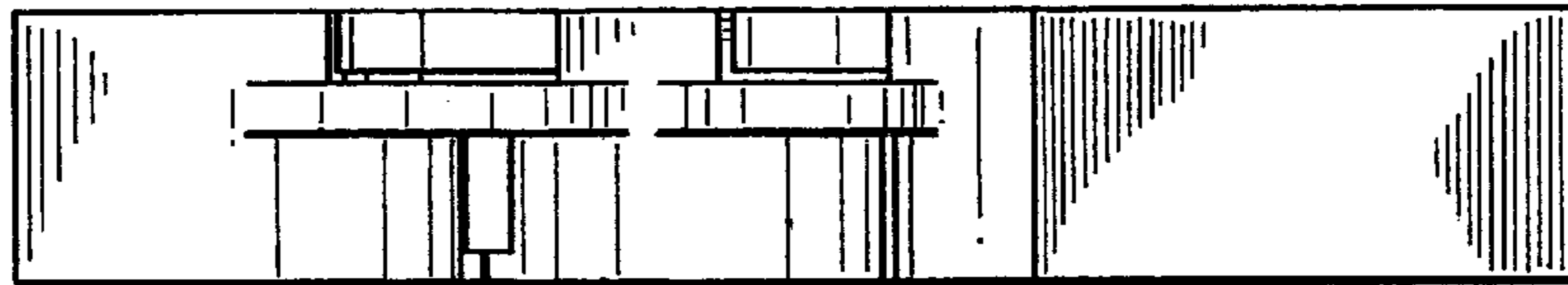

FIG. 18

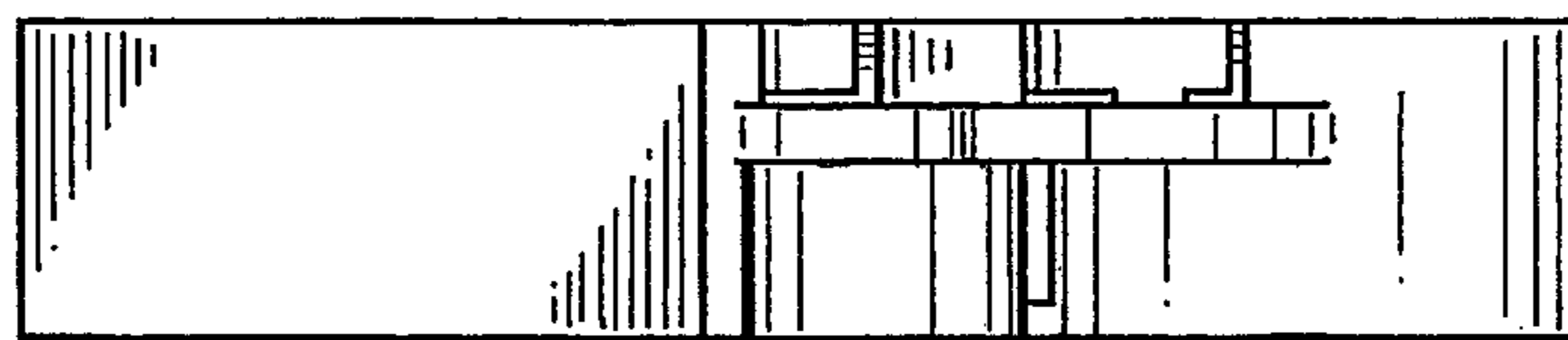

FIG. 19

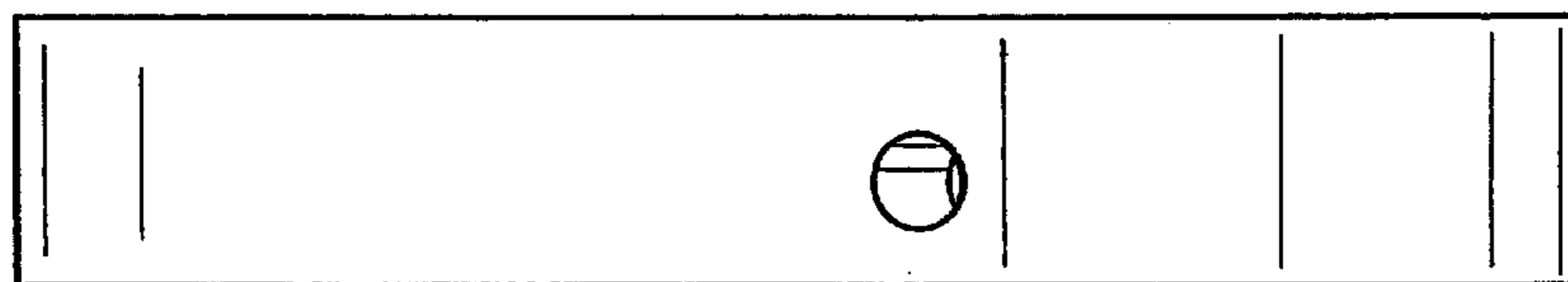

FIG. 20

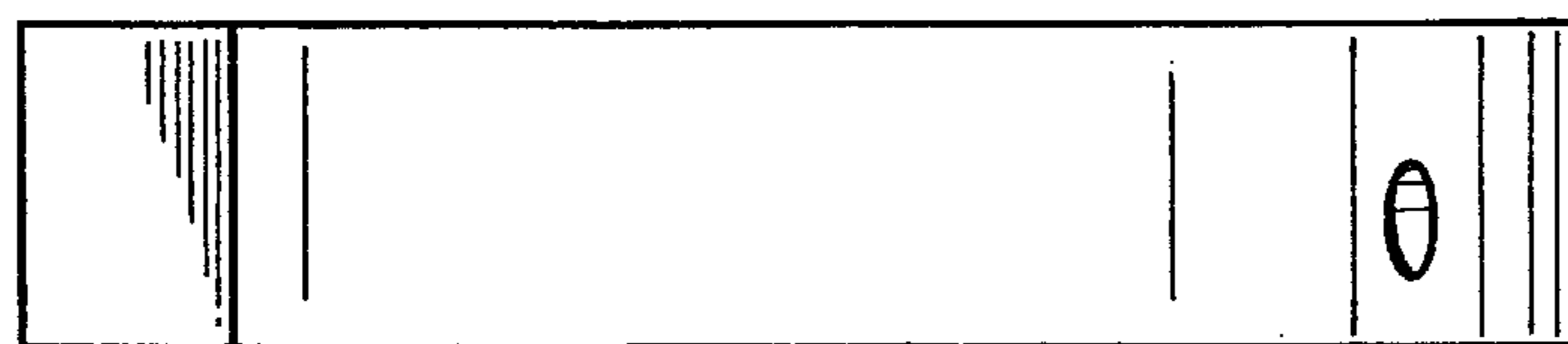

FIG. 21