



US00D669506S

(12) **United States Design Patent**
Czach et al.

(10) **Patent No.:** **US D669,506 S**

(45) **Date of Patent:** **** Oct. 23, 2012**

(54) **DOOR BIN**

(75) Inventors: **Matthew G. Czach**, Kalamazoo, MI (US); **Matthew E. Herr**, Evansville, IN (US); **Scott E. Roales**, Wadesville, IN (US); **Michael S. Seeley**, South Haven, MI (US)

(73) Assignee: **Whirlpool Corporation**, Benton Harbor, MI (US)

(**) Term: **14 Years**

(21) Appl. No.: **29/392,580**

(22) Filed: **May 24, 2011**

(51) **LOC (9) Cl.** **21-02**

(52) **U.S. Cl.** **D15/89**

(58) **Field of Classification Search** D15/79-89, D15/91; 62/3.6, 125, 126, 187, 246-255; 312/116, 138.1, 236, 321.5, 330.1, 400-409
See application file for complete search history.

(56) **References Cited**

U.S. PATENT DOCUMENTS

2,000,944 A 5/1935 Gilbert et al.
(Continued)

Primary Examiner — Mitchell Siegel

(74) *Attorney, Agent, or Firm* — Kirk W. Goodwin; Barnes & Thornburg, LLP

(57) **CLAIM**

We claim the ornamental design for a door bin, as shown and described.

DESCRIPTION

Cross-reference is made to co-pending U.S. Utility patent application Ser. No. 13/114,319 entitled “Door Bin for a Domestic Refrigerator,” which was filed on May 24, 2011, is assigned to the same assignee as the present application, and is hereby incorporated by reference.

FIG. 1 is a front perspective view of one embodiment of a design of the door bin;

FIG. 2 is a front elevation view of the door bin of FIG. 1;

FIG. 3 is a first side elevation view of the door bin of FIG. 1;

FIG. 4 is a second side elevation view of the door bin of FIG. 1;

FIG. 5 is a rear elevation view of the door bin of FIG. 1;

FIG. 6 is a top plan view of the door bin of FIG. 1;

FIG. 7 is a bottom plan view of the door bin of FIG. 1;

FIG. 8 is a front perspective view of another embodiment of a design of the door bin;

FIG. 9 is a front elevation view of the door bin of FIG. 8;

FIG. 10 is a first side elevation view of the door bin of FIG. 8;

FIG. 11 is a second side elevation view of the door bin of FIG. 8;

FIG. 12 is a rear elevation view of the door bin of FIG. 8;

FIG. 13 is a top plan view of the door bin of FIG. 8;

FIG. 14 is a bottom plan view of the door bin of FIG. 8;

FIG. 15 is a front perspective view of another embodiment of a design of the door bin;

FIG. 16 is a front elevation view of the door bin of FIG. 15;

FIG. 17 is a first side elevation view of the door bin of FIG. 15;

FIG. 18 is a second side elevation view of the door bin of FIG. 15;

FIG. 19 is a rear elevation view of the door bin of FIG. 15;

FIG. 20 is a top plan view of the door bin of FIG. 15; and,

FIG. 21 is a bottom plan view of the door bin of FIG. 15.

The portion shown in broken lines is for illustrative purposes only and forms no part of the claimed design.

1 Claim, 18 Drawing Sheets

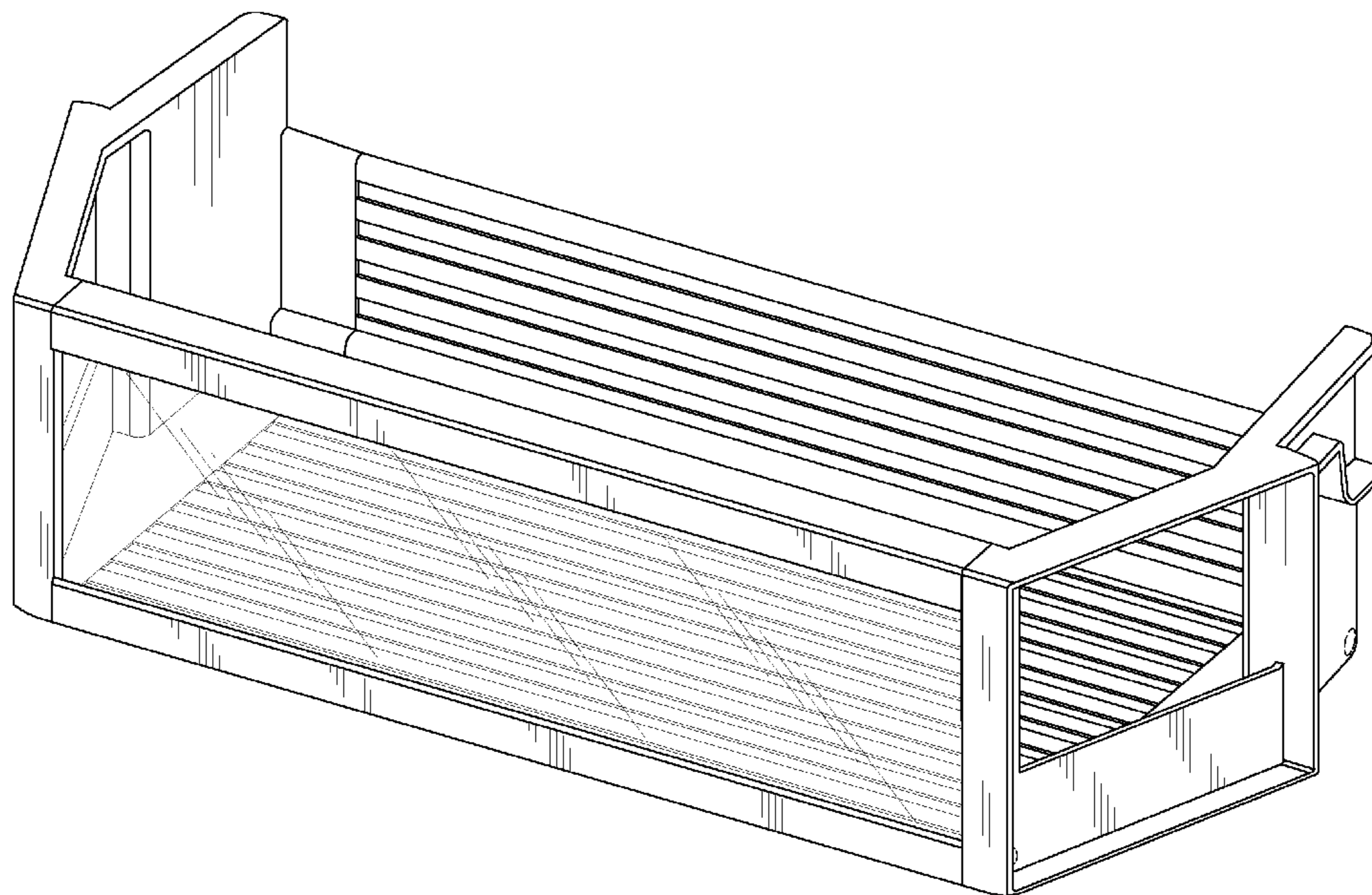

US D669,506 S

Page 2

U.S. PATENT DOCUMENTS

2,898,173	A	8/1959	Squire				
3,029,953	A	4/1962	Morrissey, Jr.				
3,227,502	A	1/1966	Roberts				
3,610,174	A	10/1971	Kesling				
3,709,576	A	1/1973	Lemoine				
4,500,147	A	2/1985	Reister				
4,801,182	A	1/1989	Metcalf et al.				
4,867,512	A	9/1989	Wilkins et al.				
5,004,305	A	4/1991	Montuoro et al.				
5,042,398	A	8/1991	Lau et al.				
D344,739	S *	3/1994	Edman et al.	D15/89		
5,346,299	A *	9/1994	Werkmeister et al.	312/405.1		
5,370,455	A *	12/1994	Sedovic et al.	312/405.1		
5,375,924	A	12/1994	Pohl et al.				
5,951,134	A	9/1999	Braun et al.				
6,231,146	B1	5/2001	Dang				
6,582,038	B2	6/2003	Moreno-Olguin et al.				
D490,091	S *	5/2004	Quinlan	D15/89		
6,799,818	B2	10/2004	Ahmed et al.				
D511,177	S *	11/2005	Jackovin et al.	D15/89		
D511,179	S *	11/2005	Tunzi	D15/89		
6,997,526	B2	2/2006	Leimkuehler et al.				
7,293,846	B2 *	11/2007	Collins et al.	312/405.1		
7,472,974	B2	1/2009	Czach et al.				
D590,424	S *	4/2009	Baacke et al.	D15/89		
D591,315	S *	4/2009	Baacke et al.	D15/89		
7,665,326	B2	2/2010	LeClear et al.				
7,748,805	B2	7/2010	Lucas et al.				
D649,985	S *	12/2011	Jeon et al.	D15/89		
2010/0126202	A1	5/2010	Flores et al.				

* cited by examiner

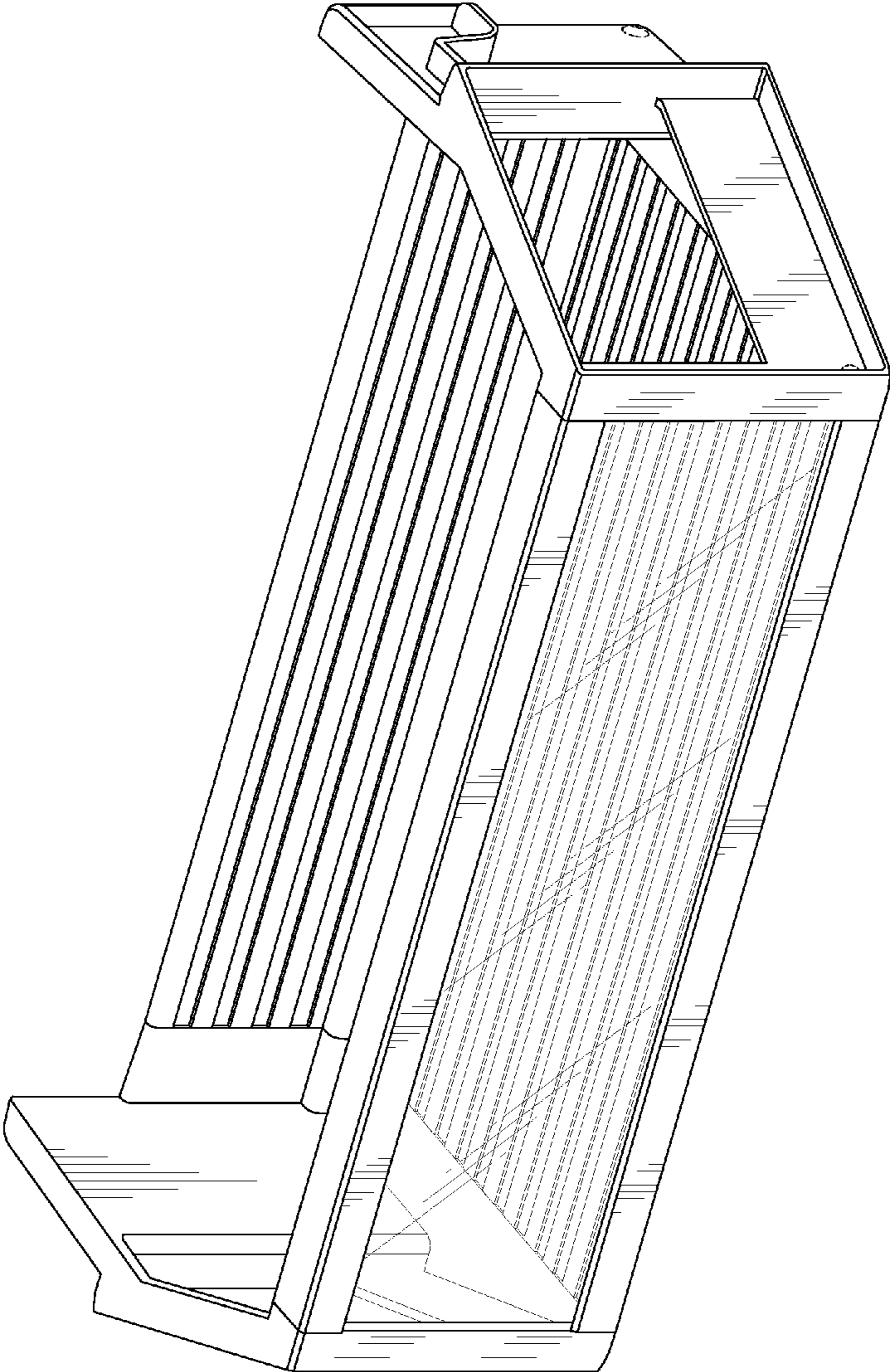

Fig. 1

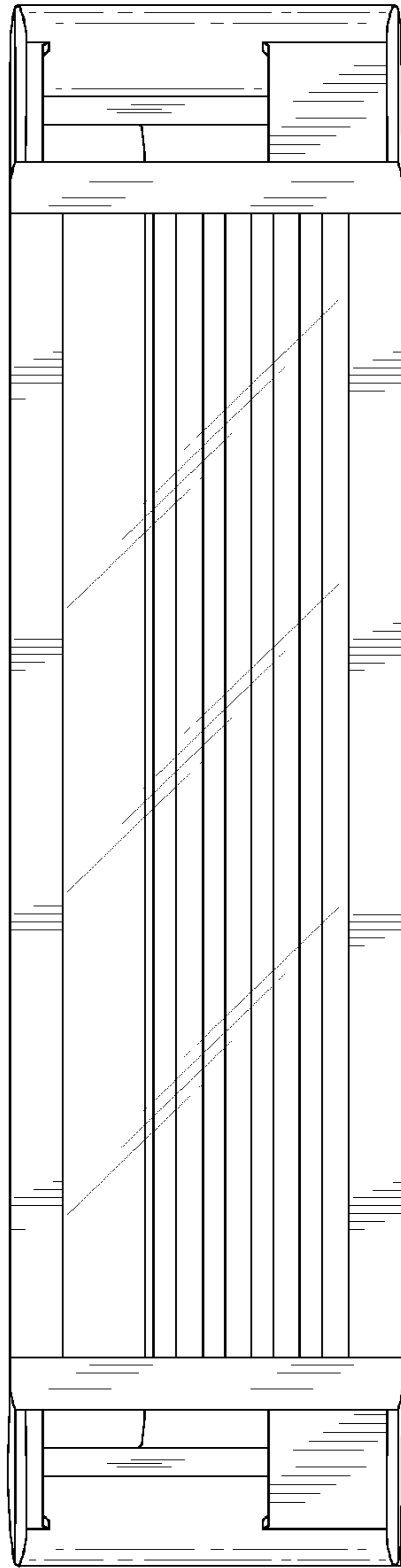

Fig. 2

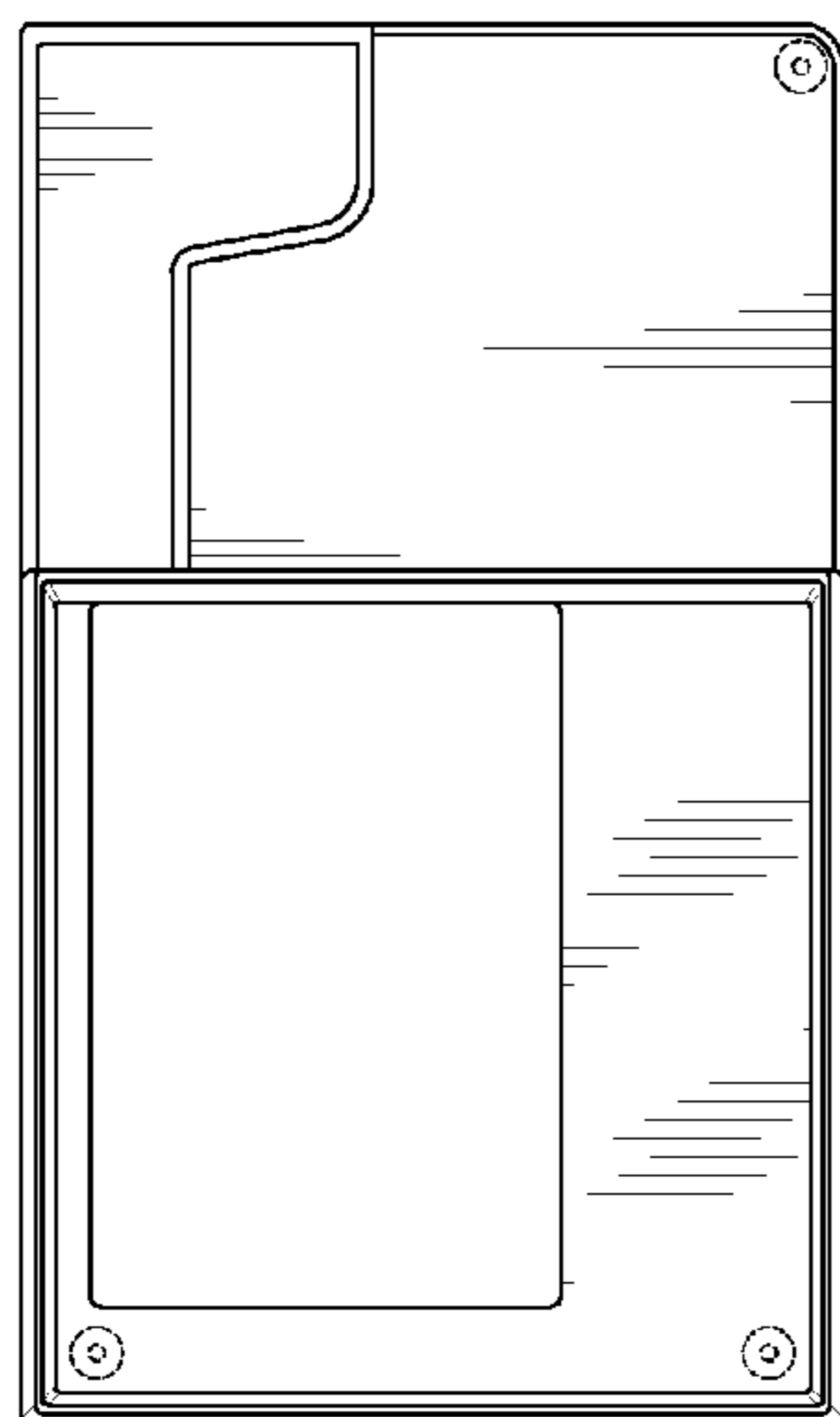

Fig. 3

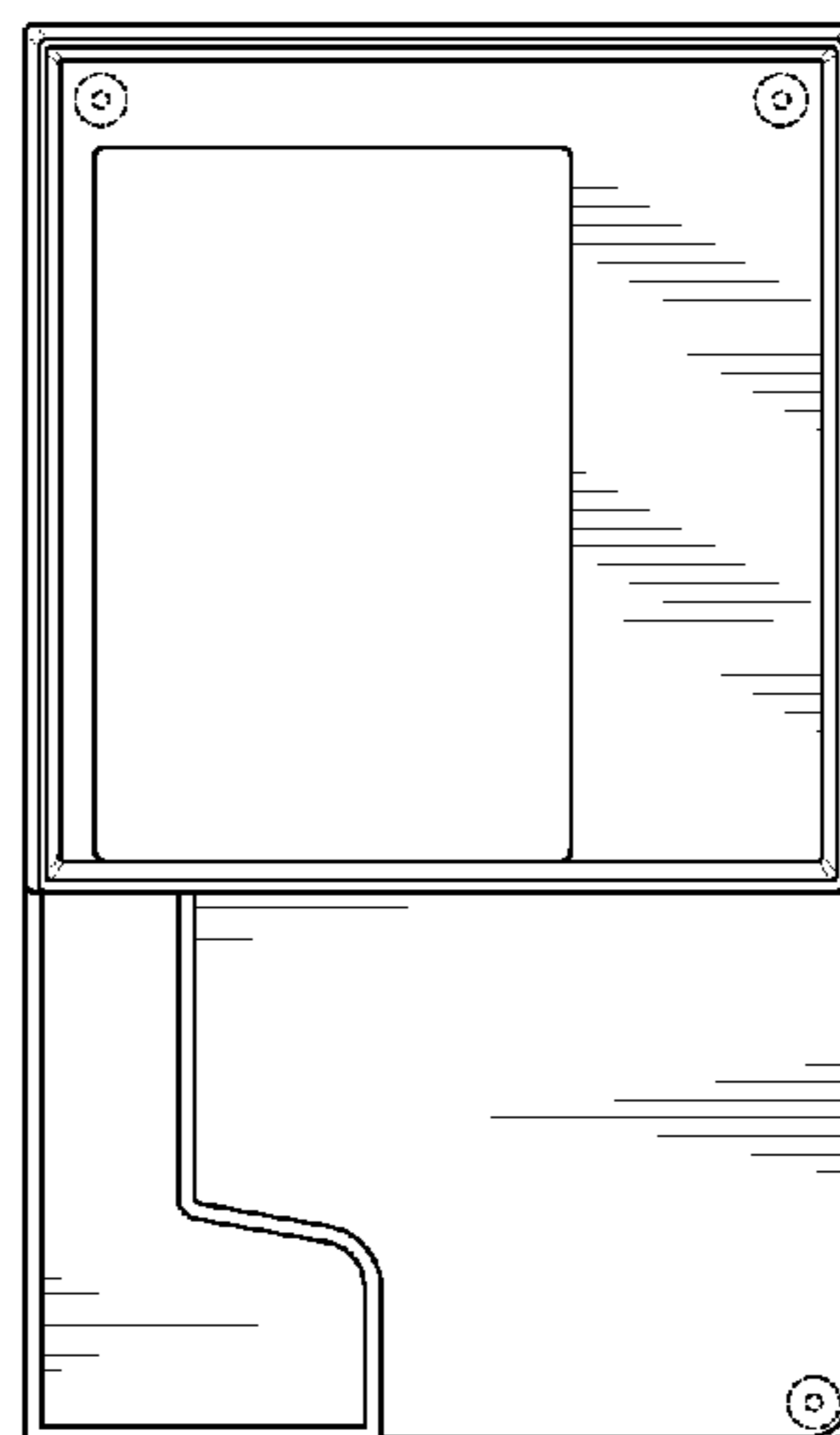

Fig. 4

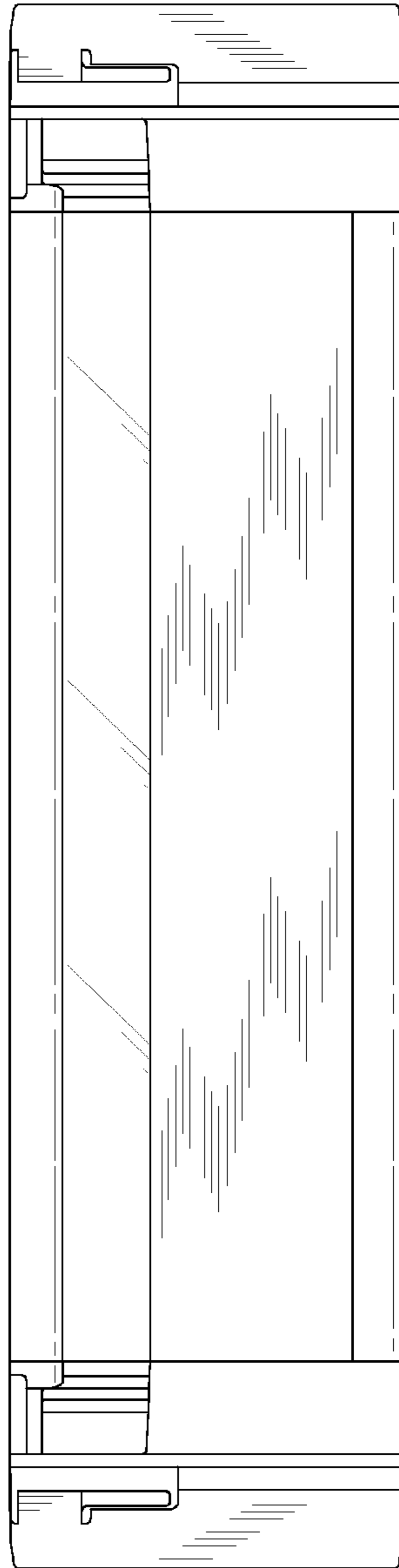

Fig. 5

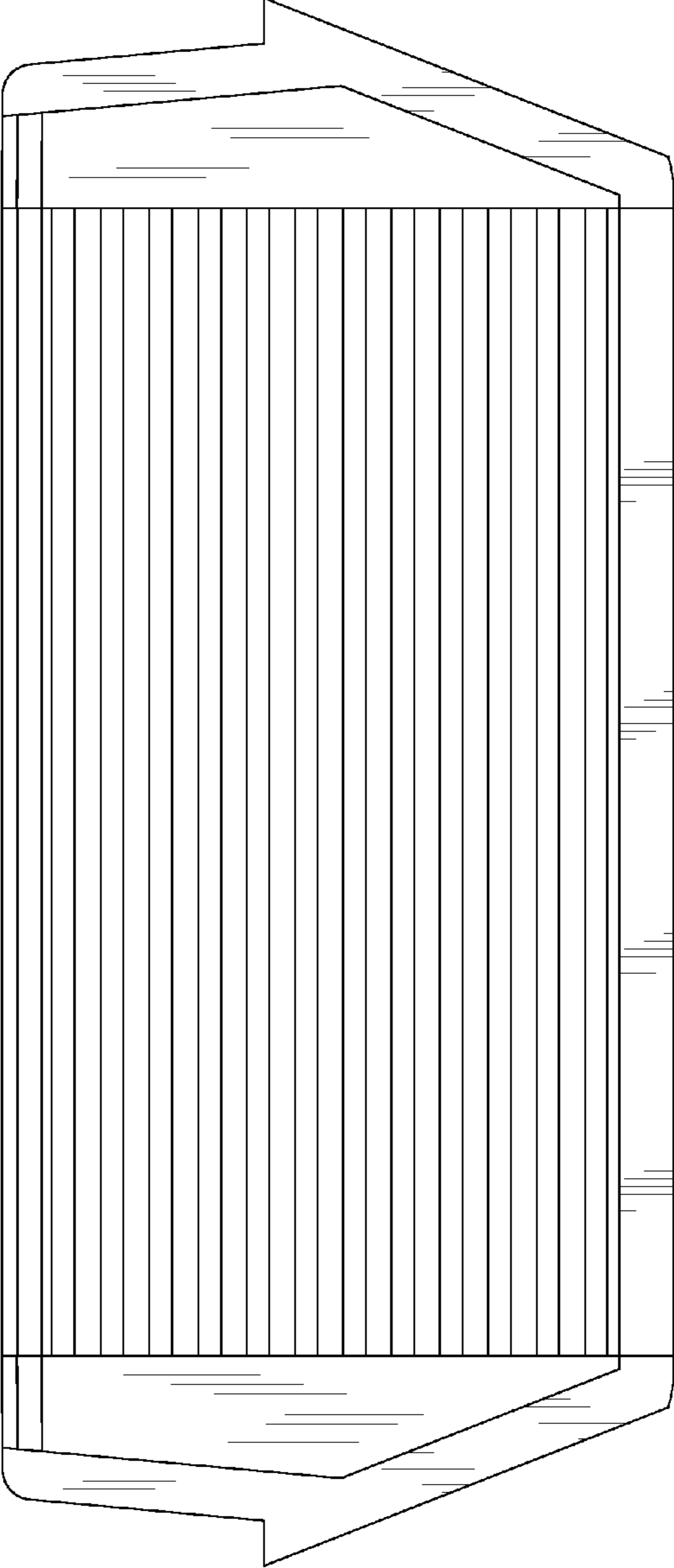

Fig. 6

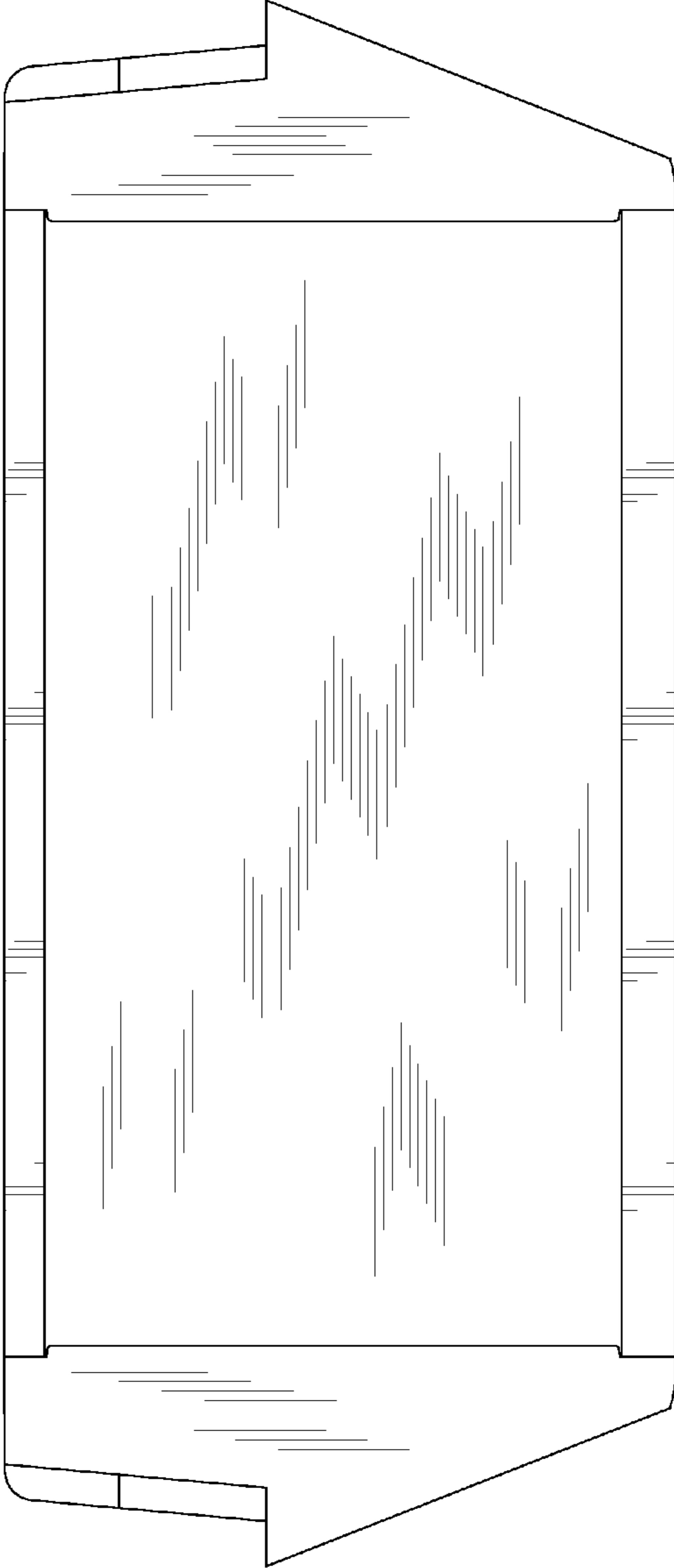

Fig. 7

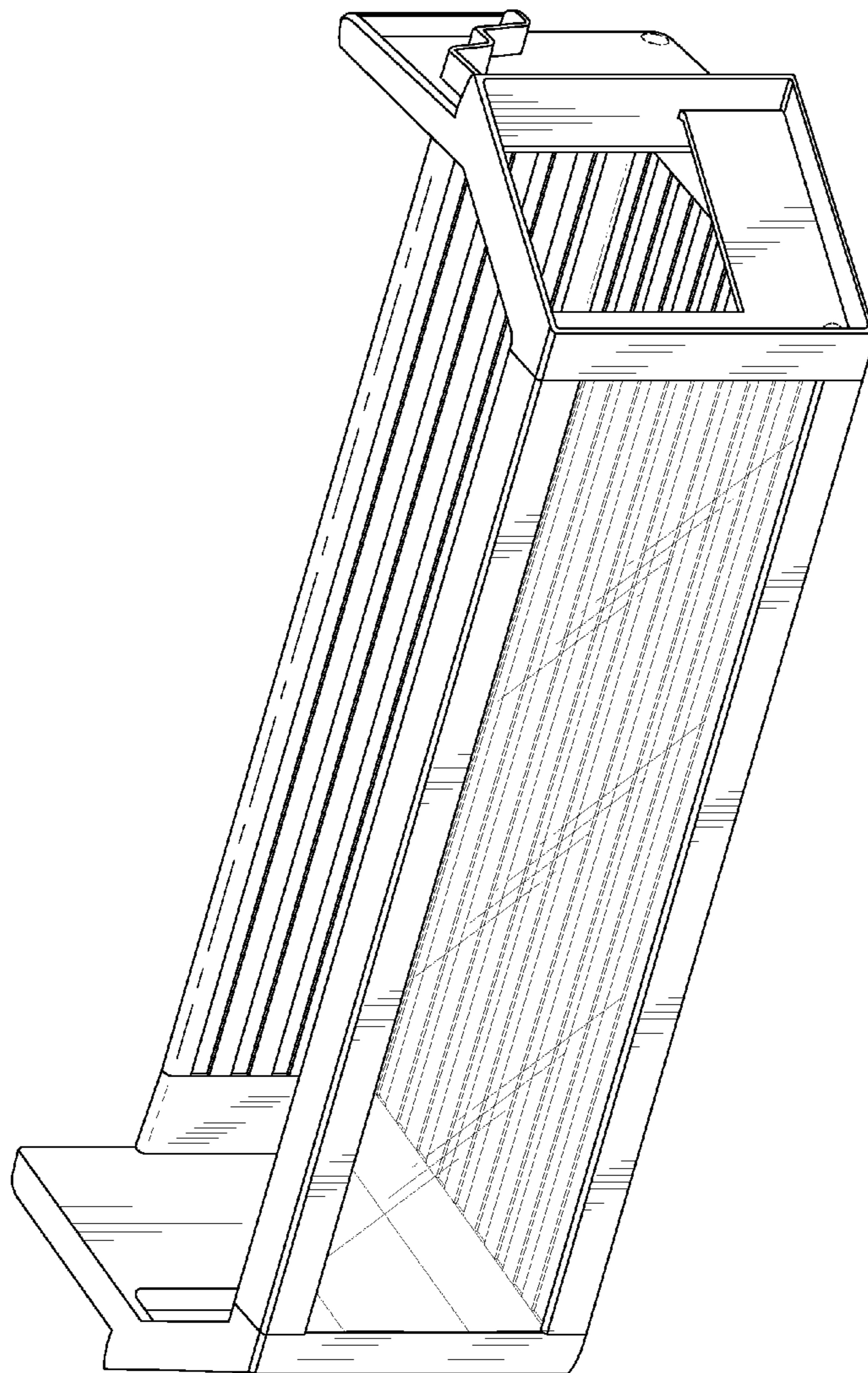

Fig. 8

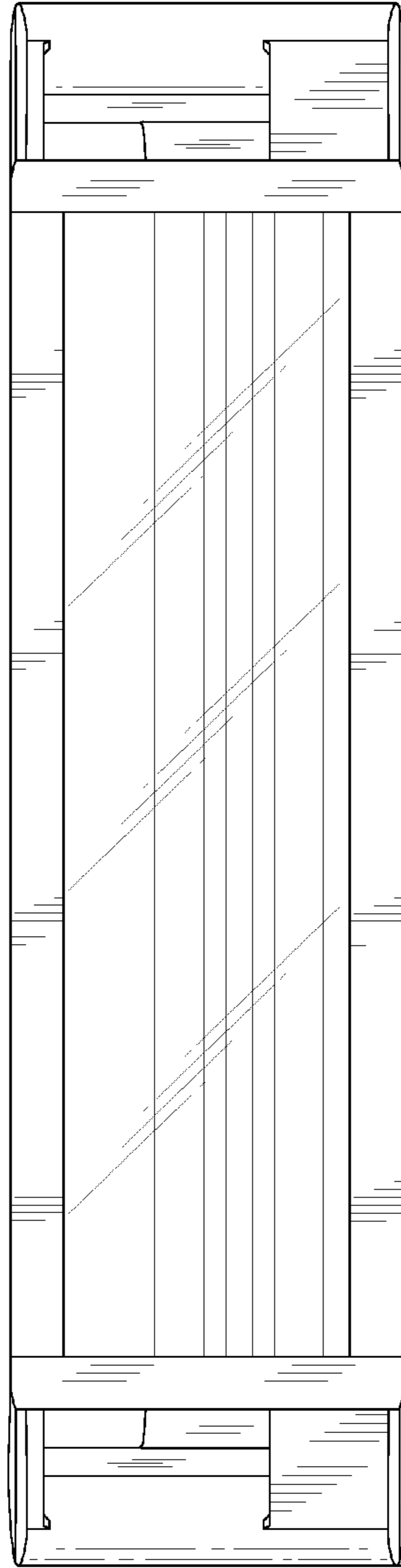

Fig. 9

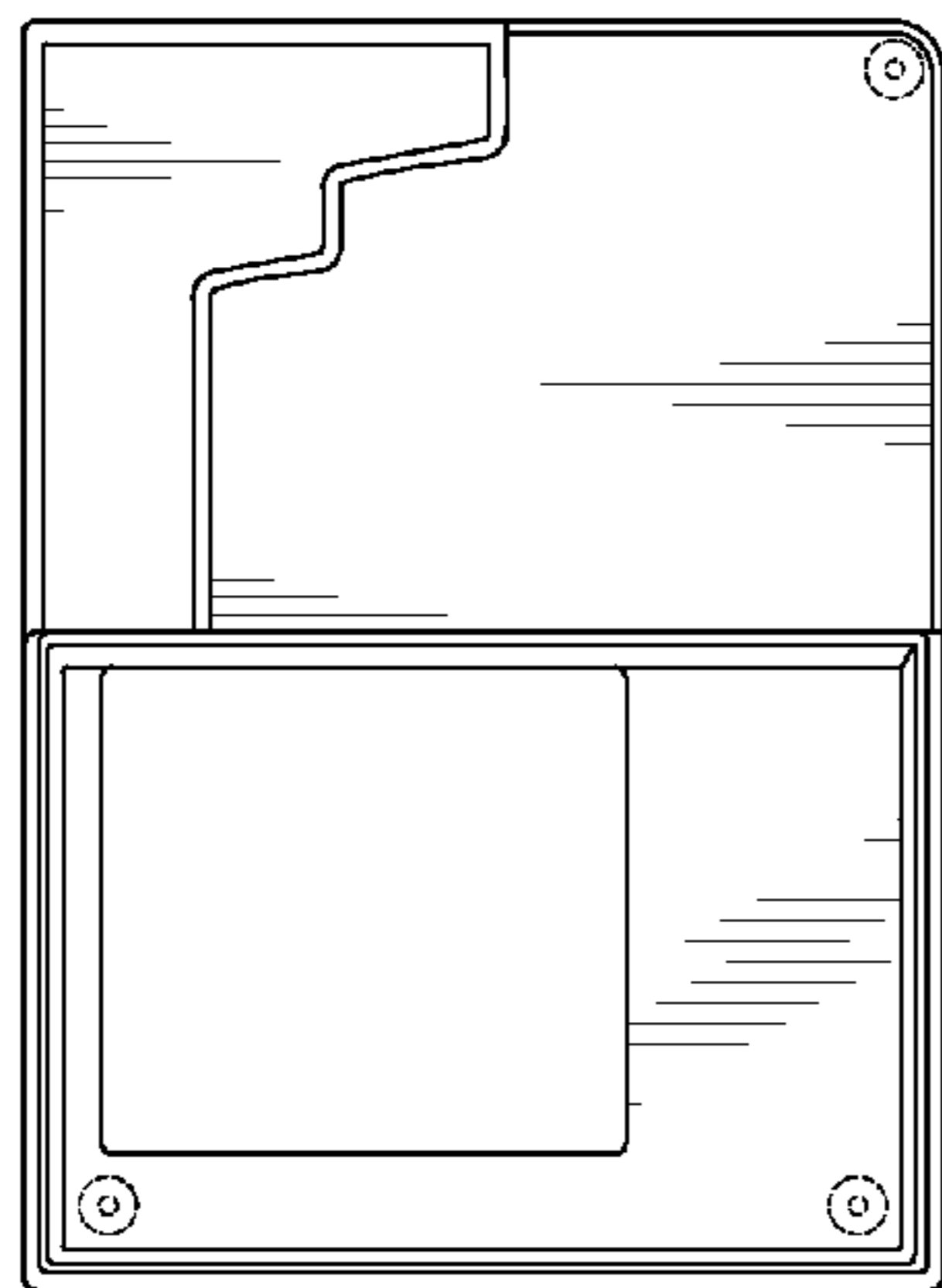

Fig. 10

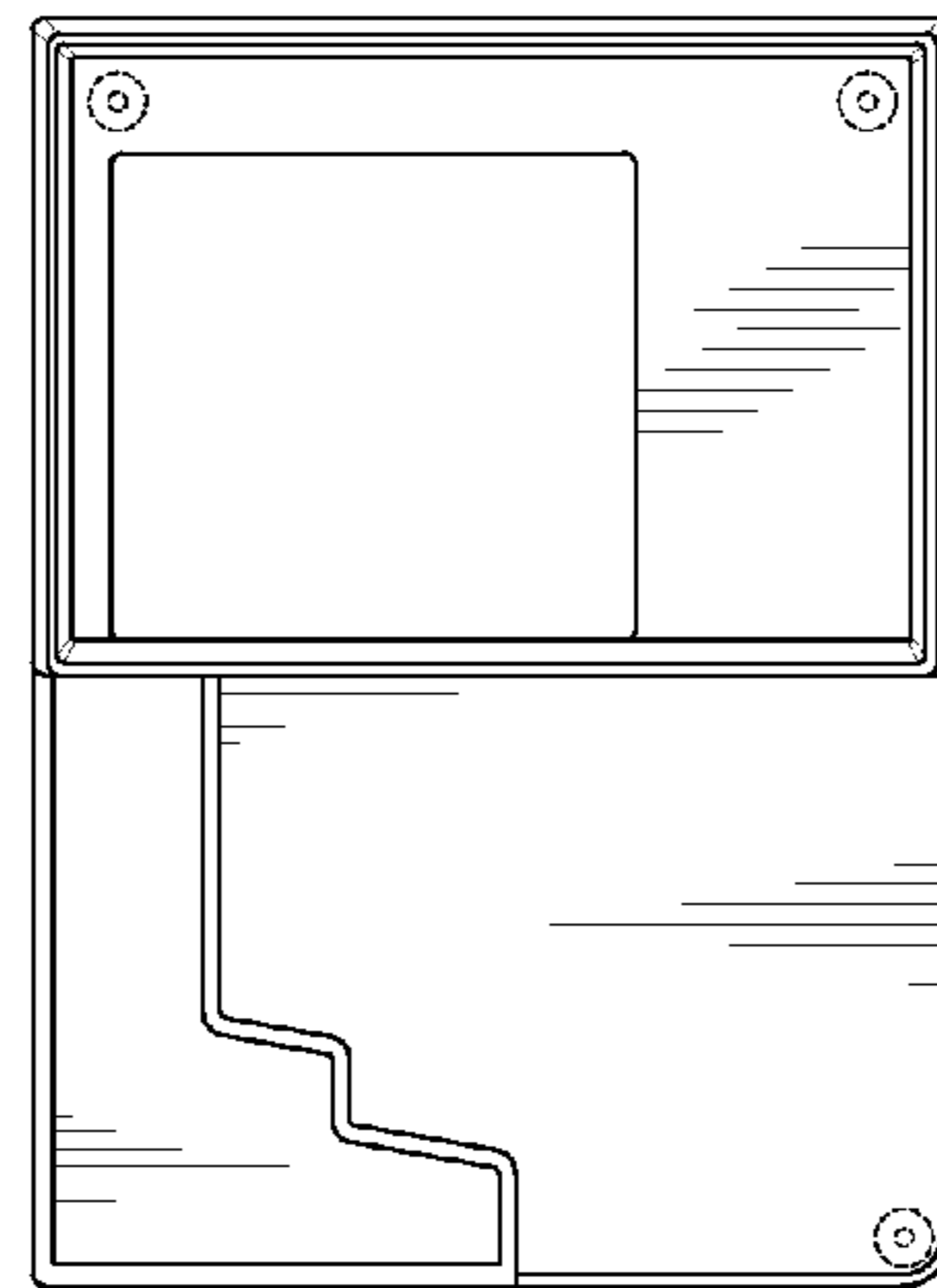

Fig. 11

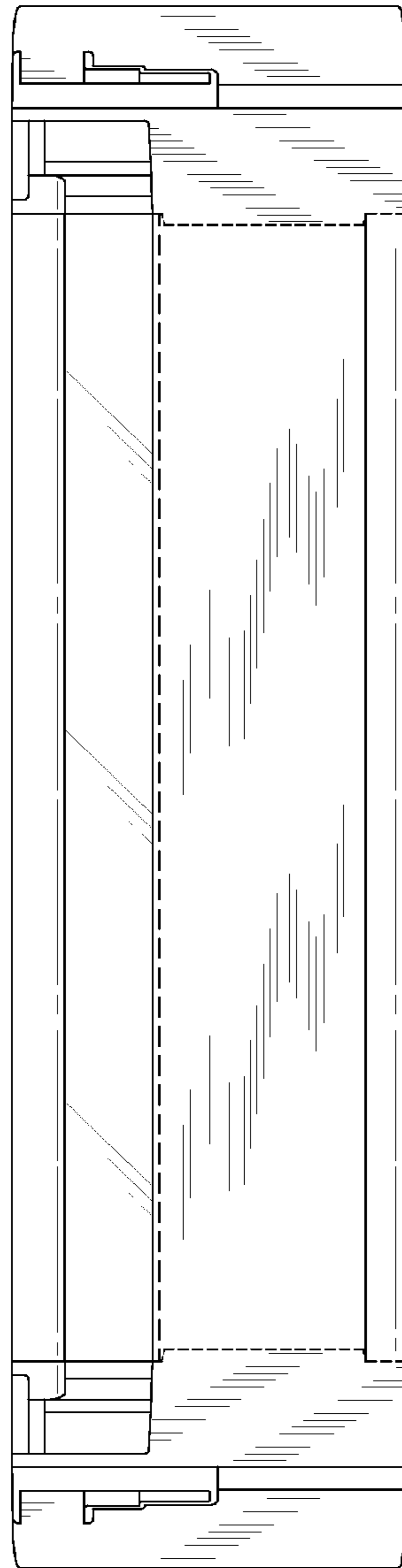

Fig. 12

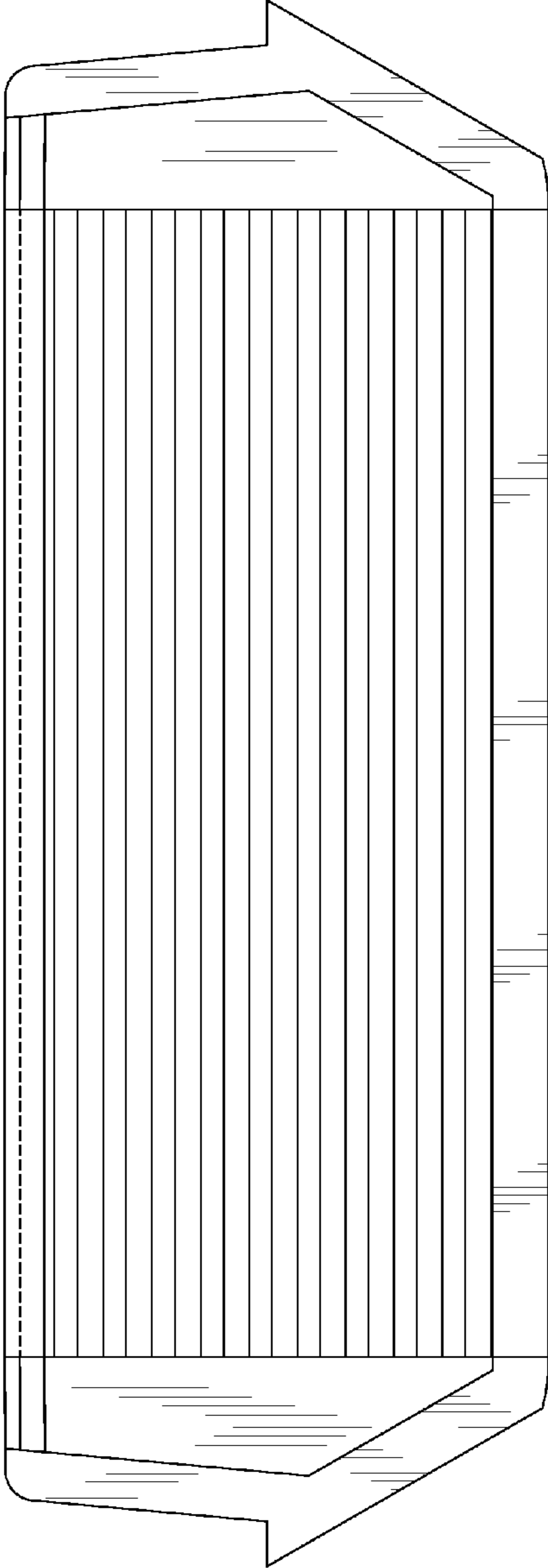

Fig. 13

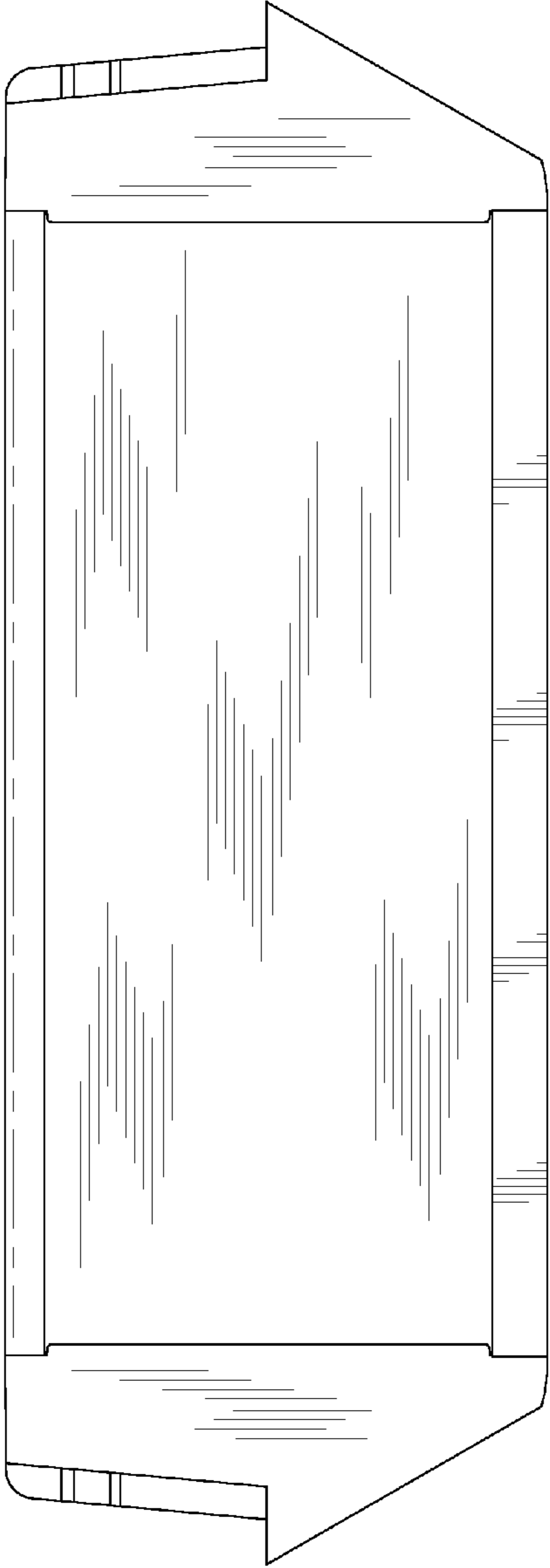

Fig. 14

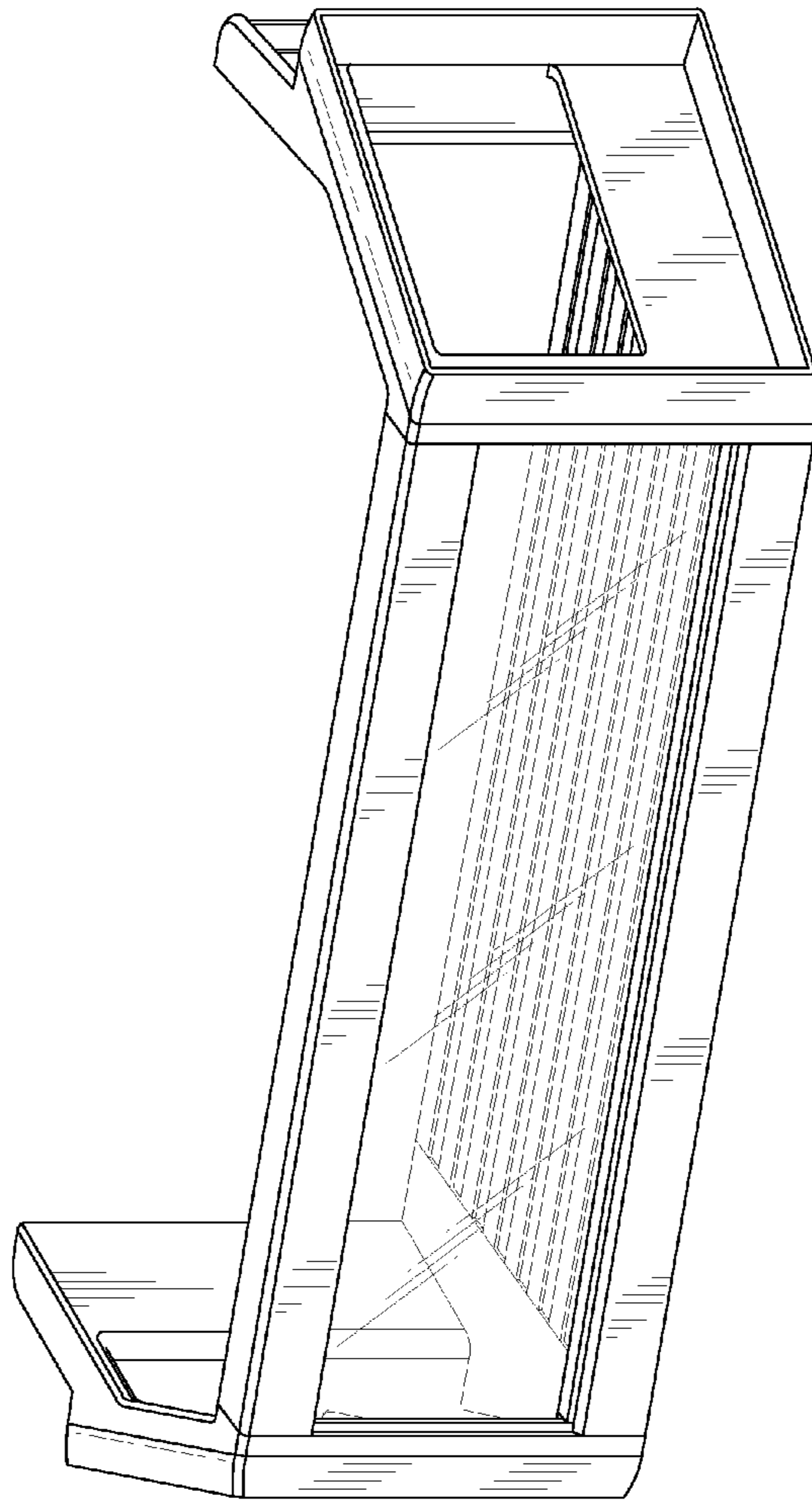

Fig. 15

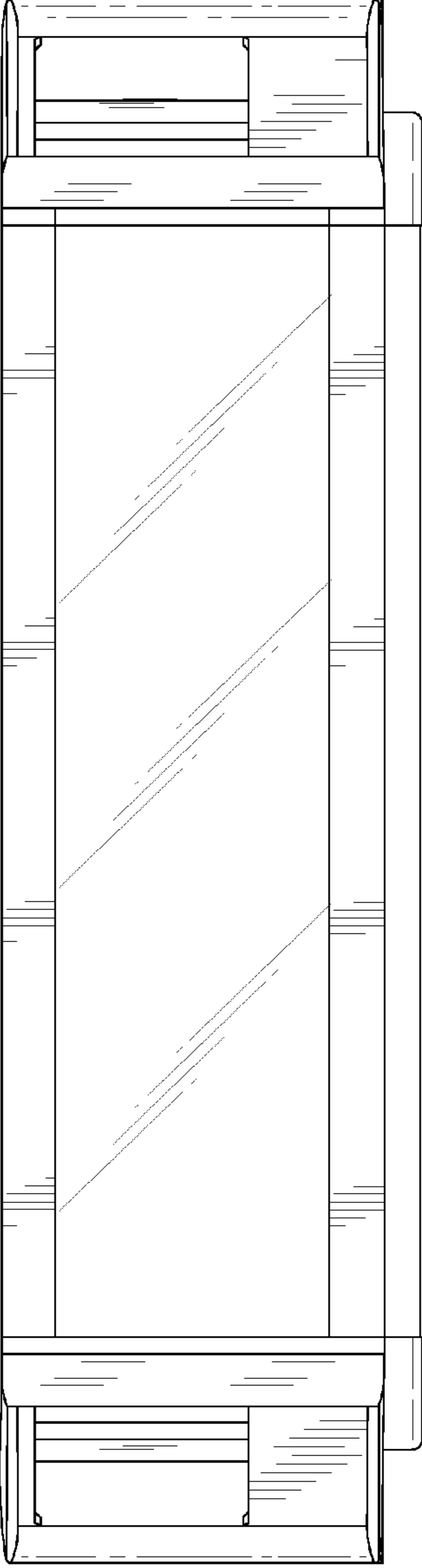

Fig. 16

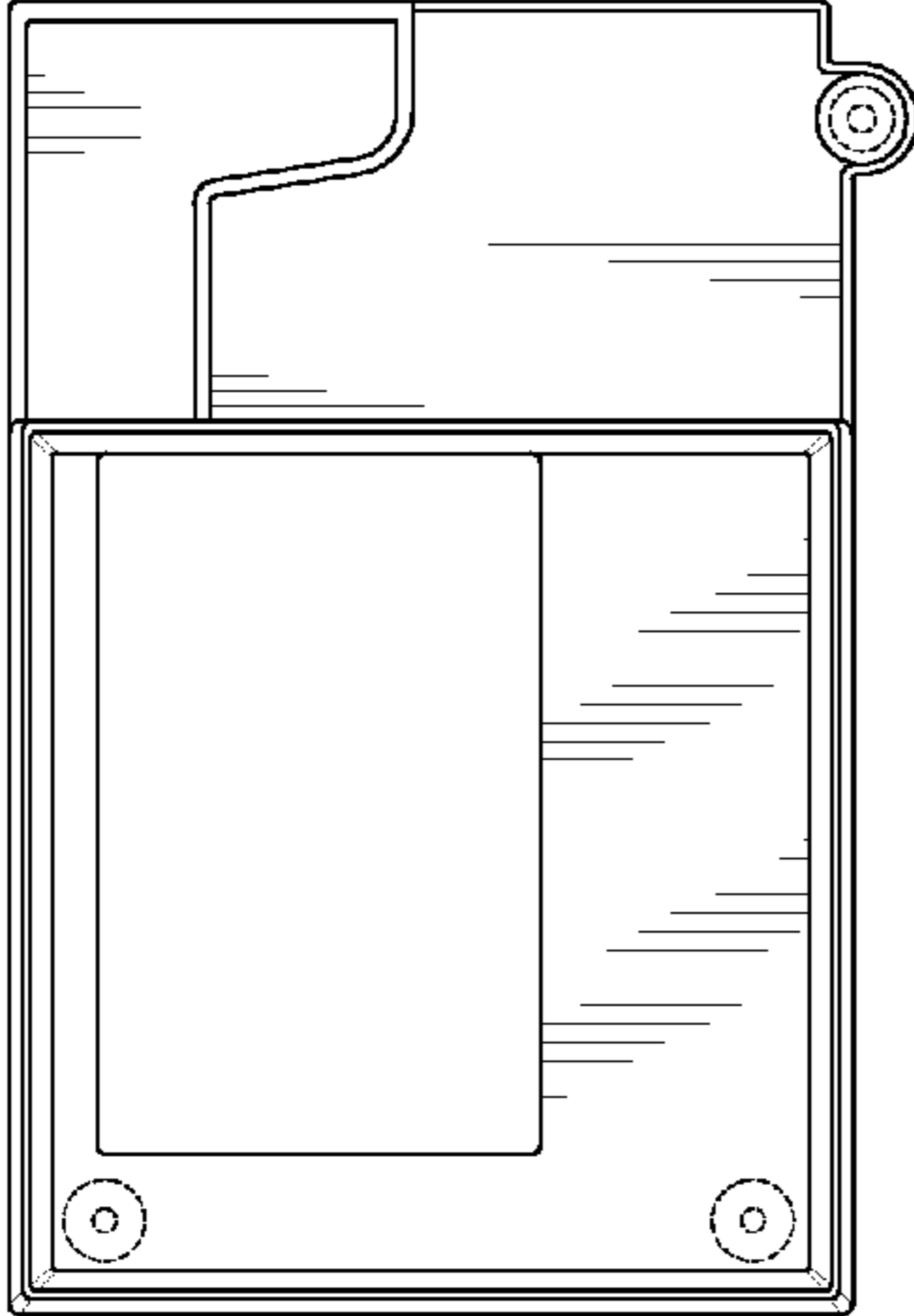

Fig. 17

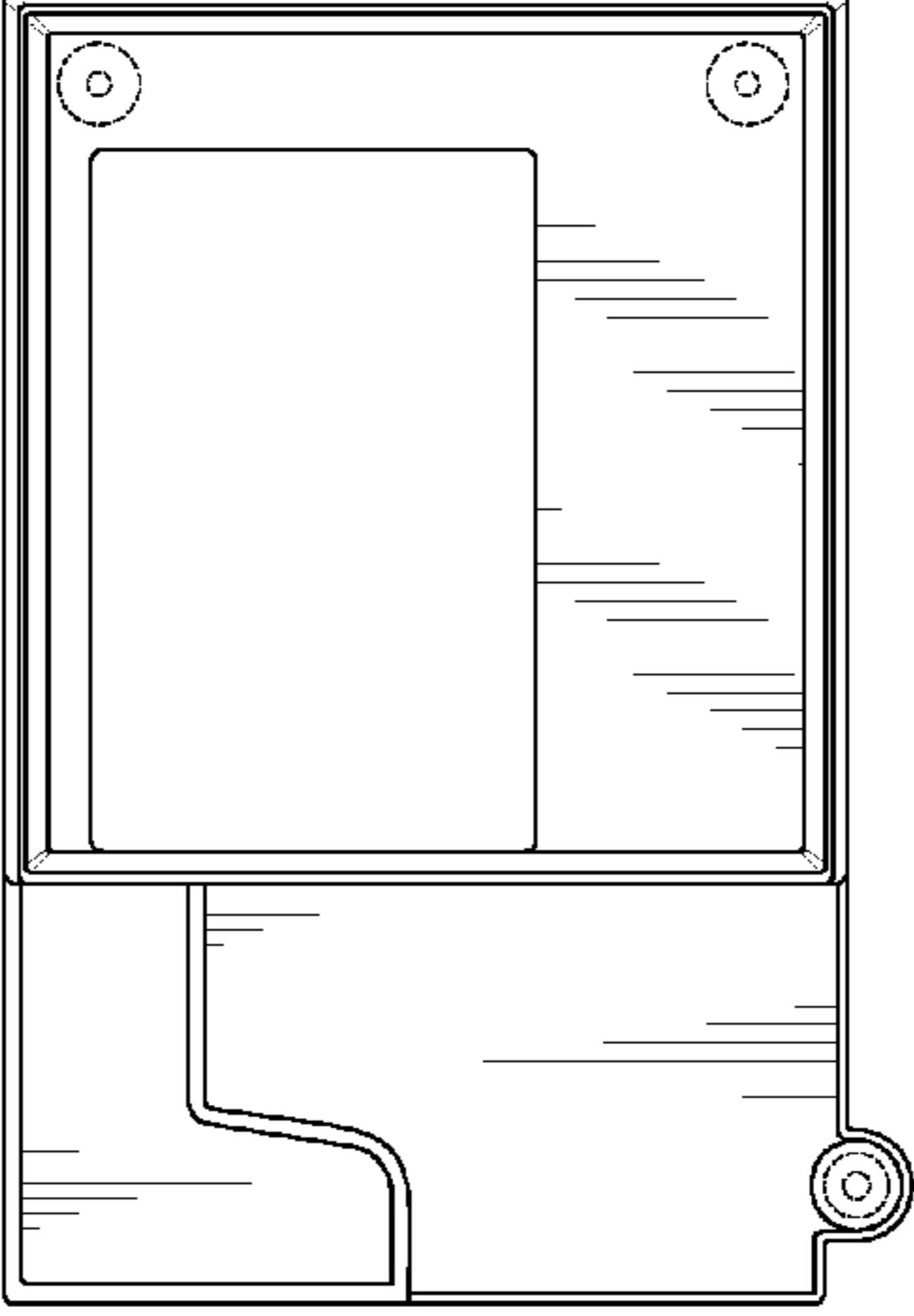

Fig. 18

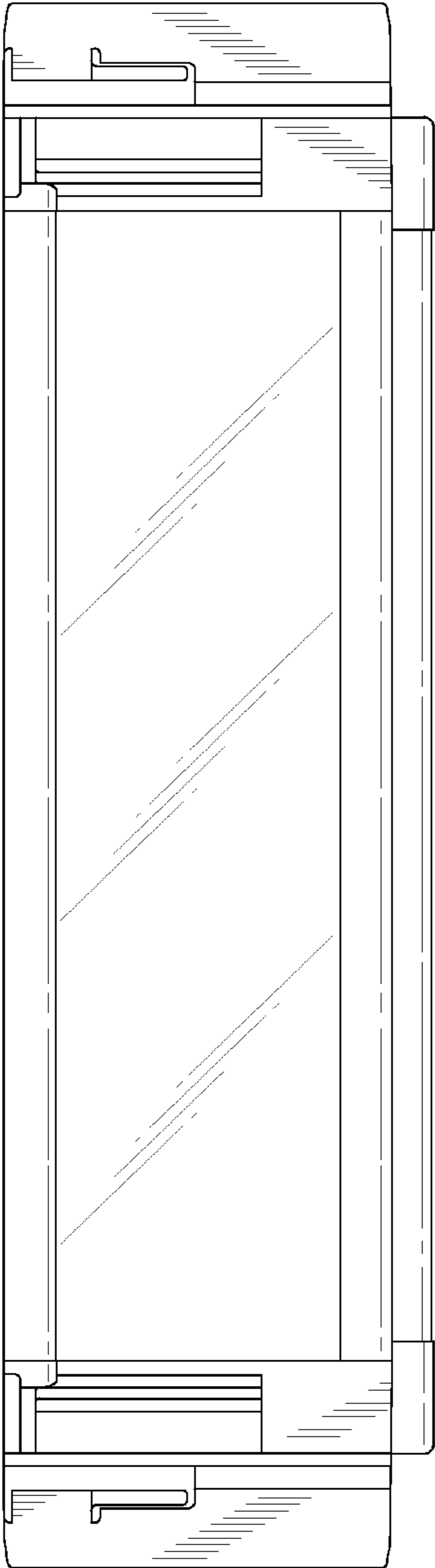

Fig. 19

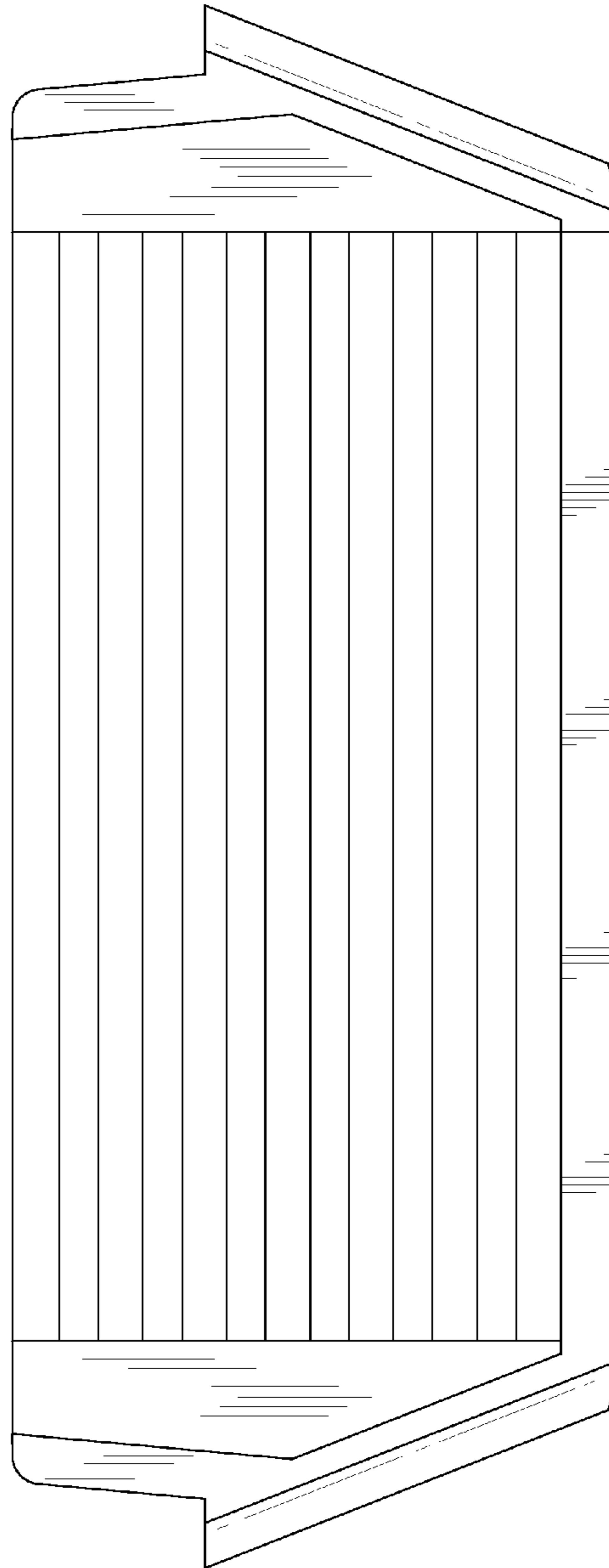

Fig. 20

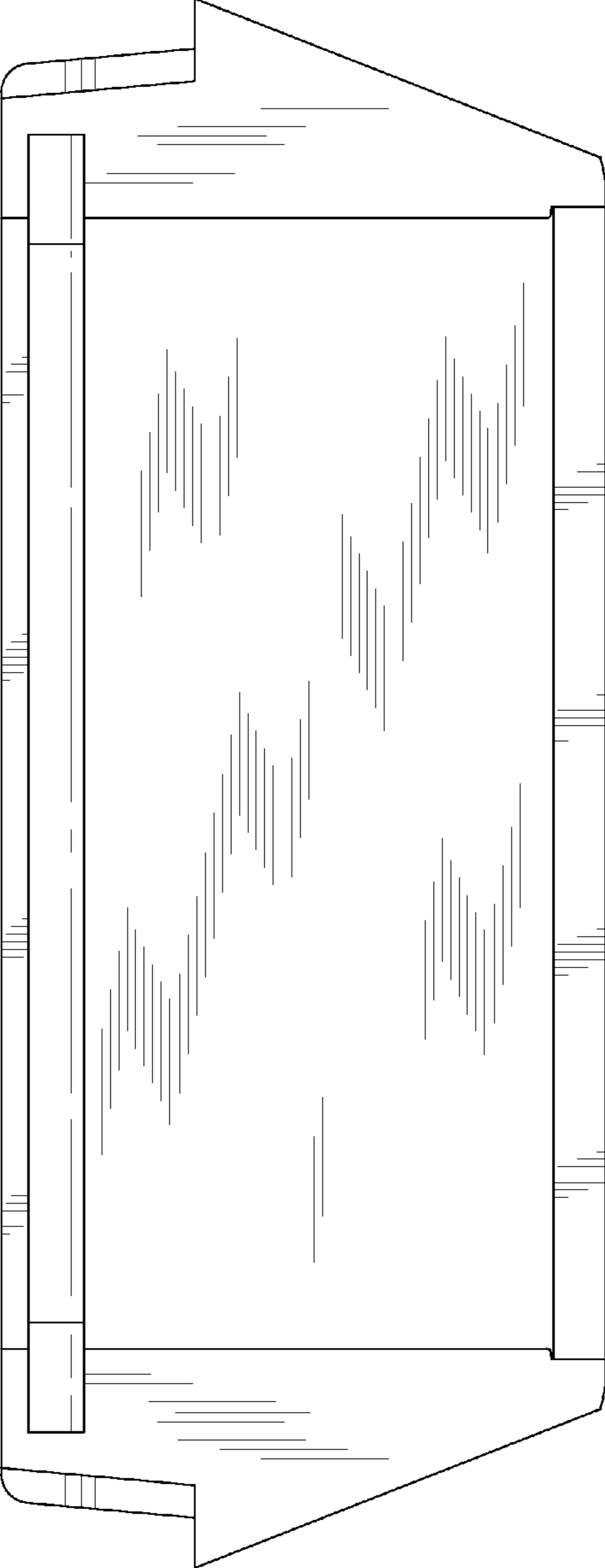

Fig. 21