

US00D669402S

(12) **United States Design Patent**
Elmitt

(10) **Patent No.:** **US D669,402 S**
(45) **Date of Patent:** **** Oct. 23, 2012**

(54) **FRONT BUMPER FOR A VEHICLE**

FOREIGN PATENT DOCUMENTS

(75) Inventor: **Karl-Johann Elmitt**, Eching (DE)

WO DM/068441 1/2007

* cited by examiner

(73) Assignee: **Bayerische Motoren Werke Aktiengesellschaft**, Munich (DE)

Primary Examiner — Melody N Brown

(74) *Attorney, Agent, or Firm* — Crowell & Moring LLP

(**) Term: **14 Years**

(21) Appl. No.: **29/396,237**

(57) **CLAIM**

The ornamental design for a front bumper for a vehicle, as shown and described.

(22) Filed: **Jun. 28, 2011**

(51) **LOC (9) Cl.** **12-16**

(52) **U.S. Cl.** **D12/169**

(58) **Field of Classification Search** D12/169,
D12/196, 171, 216, 163, 86, 90-92; 293/102,
293/113, 115, 117, 120; 296/180.1, 180.2
See application file for complete search history.

DESCRIPTION

FIG. 1 is a right perspective view of a front bumper for a vehicle according to my design;
FIG. 2 is a left perspective view thereof;
FIG. 3 is a front view thereof;
FIG. 4 is a left side view thereof;
FIG. 5 is a right side view thereof;
FIG. 6 is a top view thereof; and,
FIG. 7 is a bottom view thereof.
The broken lines are for illustrative purposes only and form no part of the claimed design.

(56) **References Cited**

U.S. PATENT DOCUMENTS

D570,261 S	*	6/2008	Baum	D12/169
D606,465 S	*	12/2009	Weil	D12/169
D620,843 S	*	8/2010	Froehlich	D12/92
D637,124 S	*	5/2011	Faghihzadeh	D12/169
D638,758 S	*	5/2011	Faghihzadeh	D12/169

1 Claim, 3 Drawing Sheets

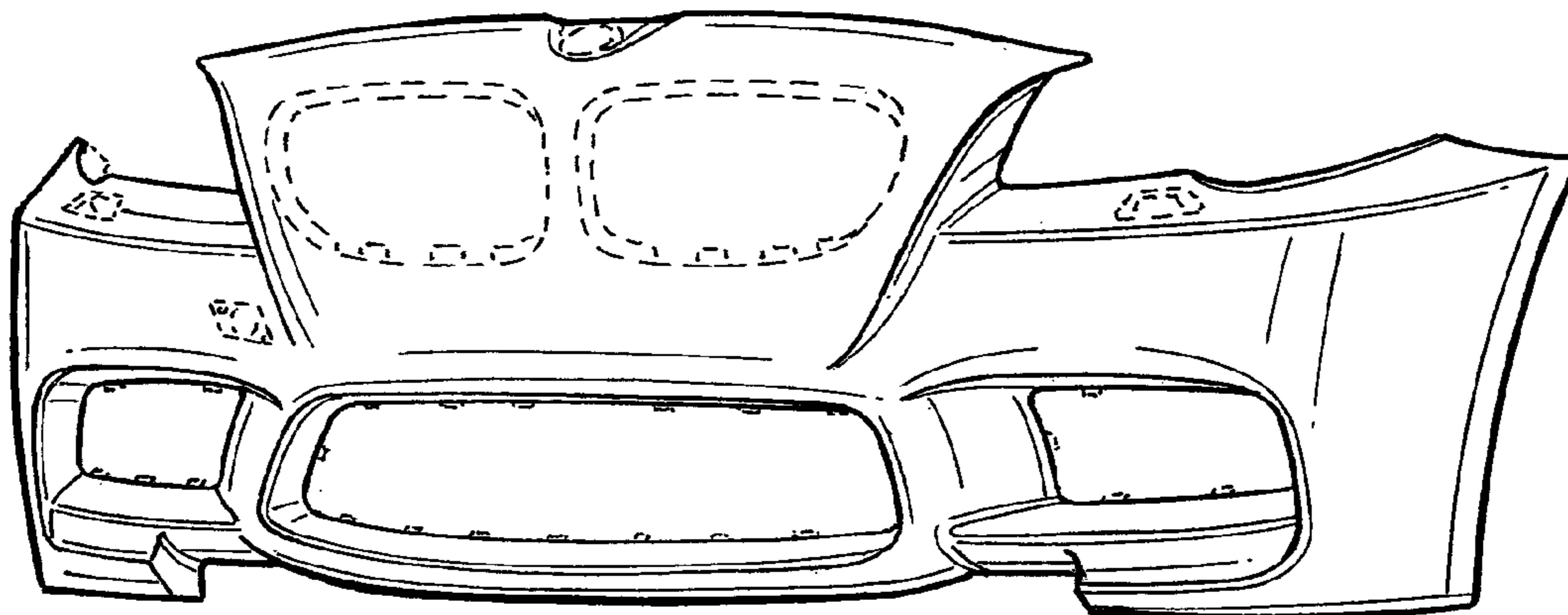

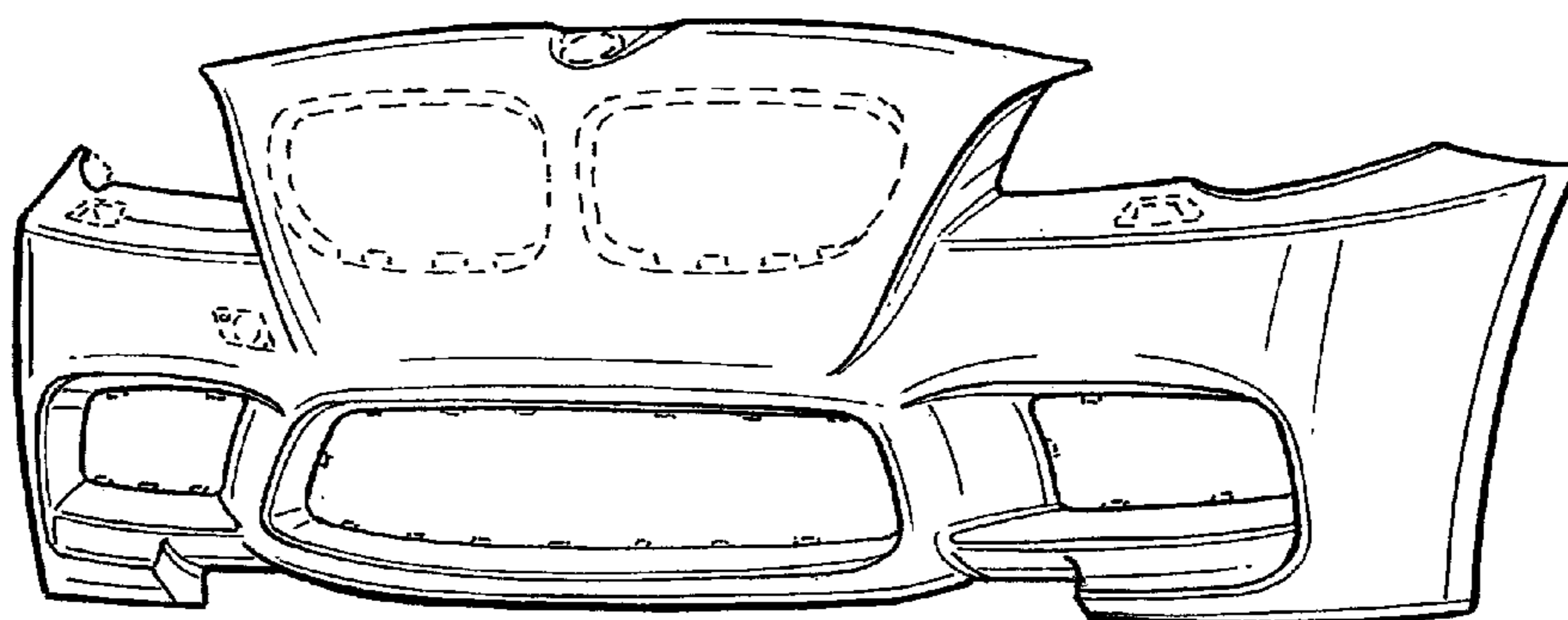

FIG. 1

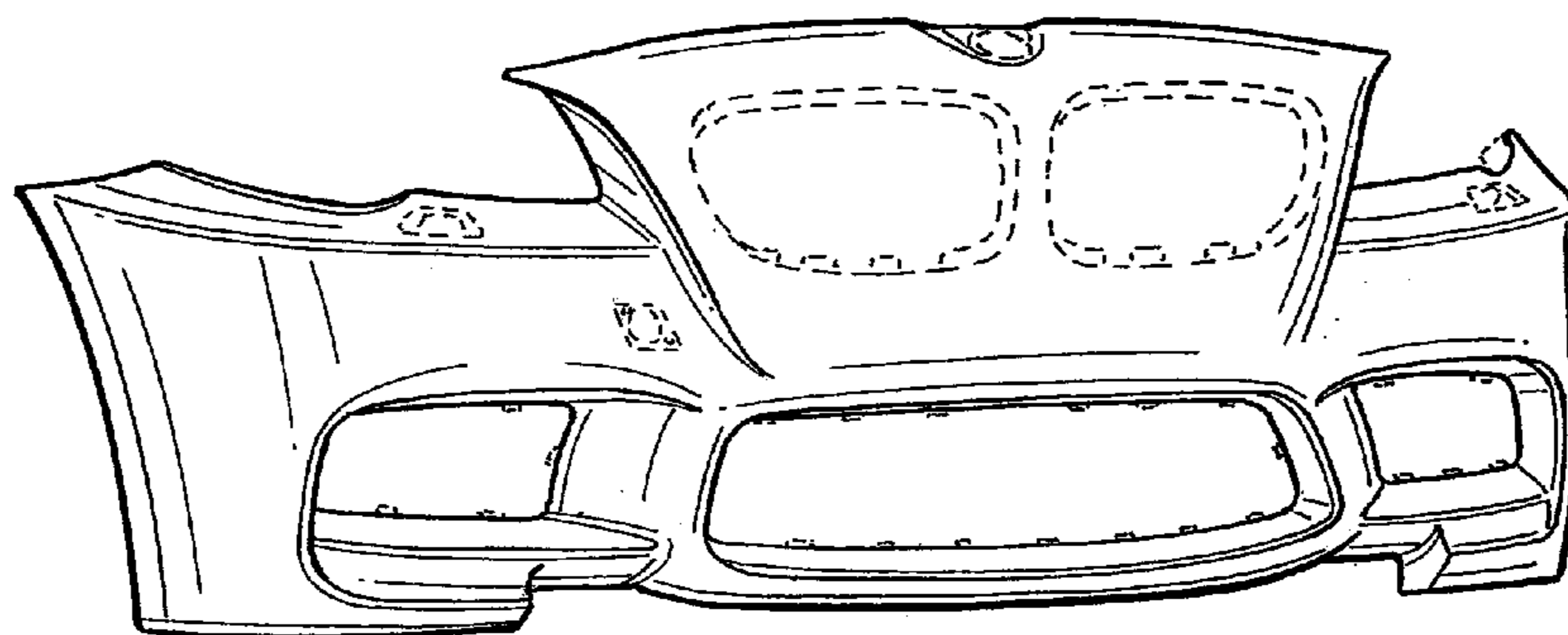

FIG. 2

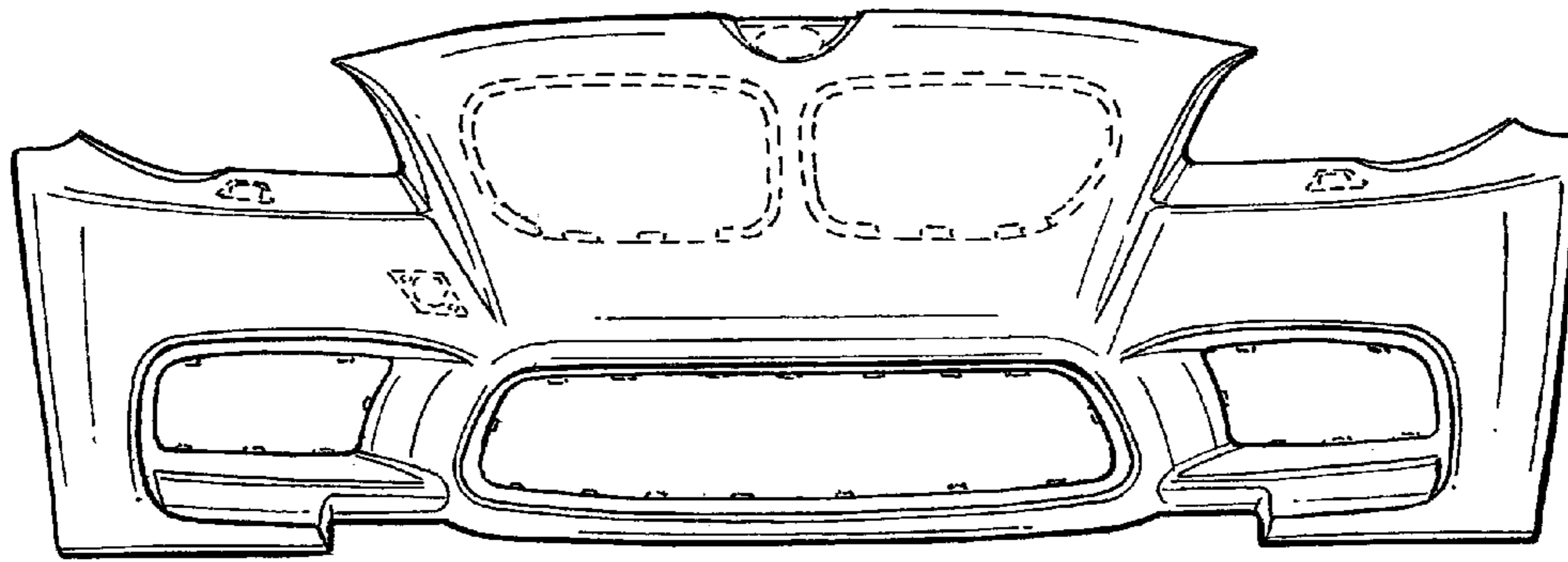

FIG. 3

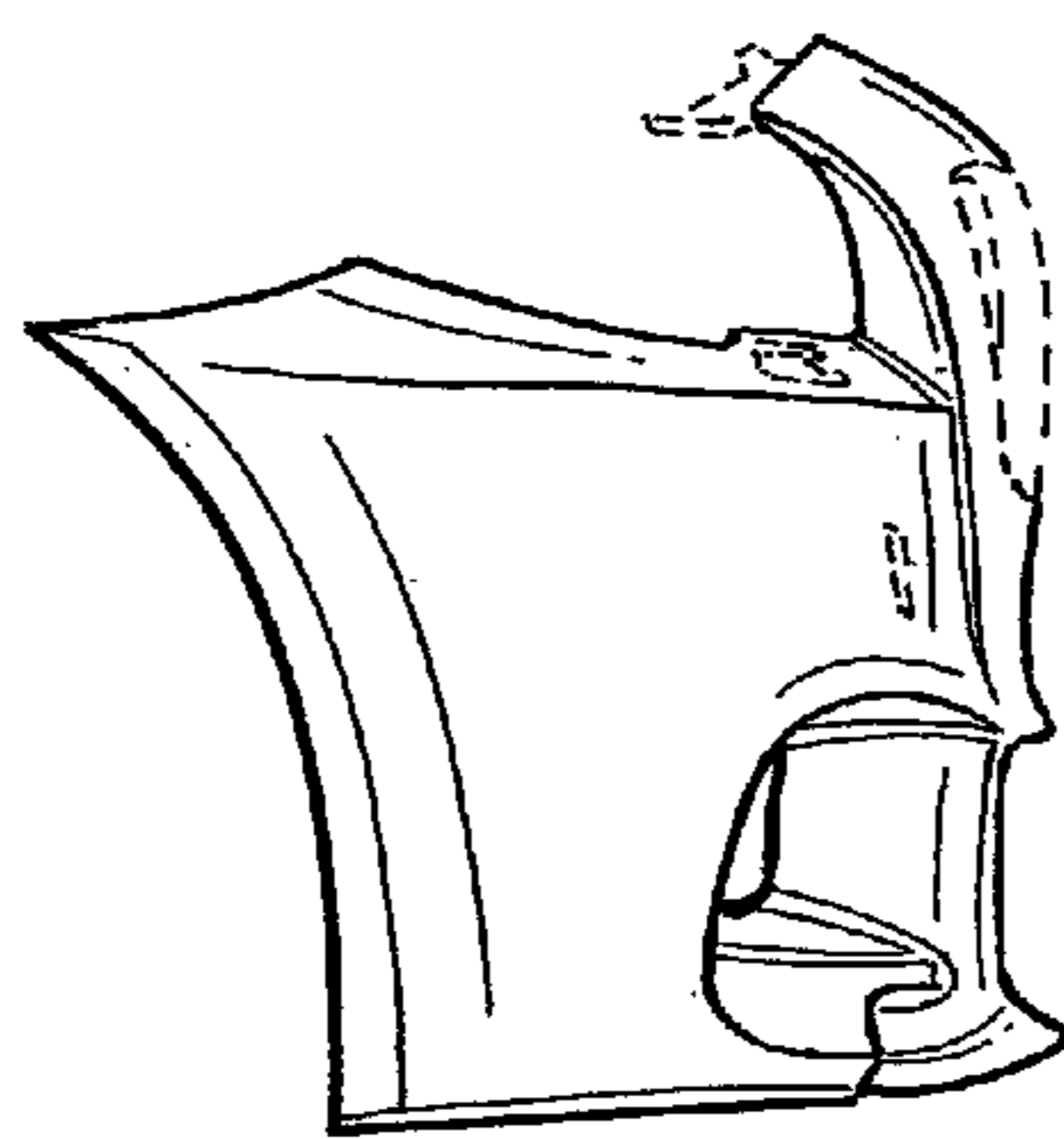

FIG. 4

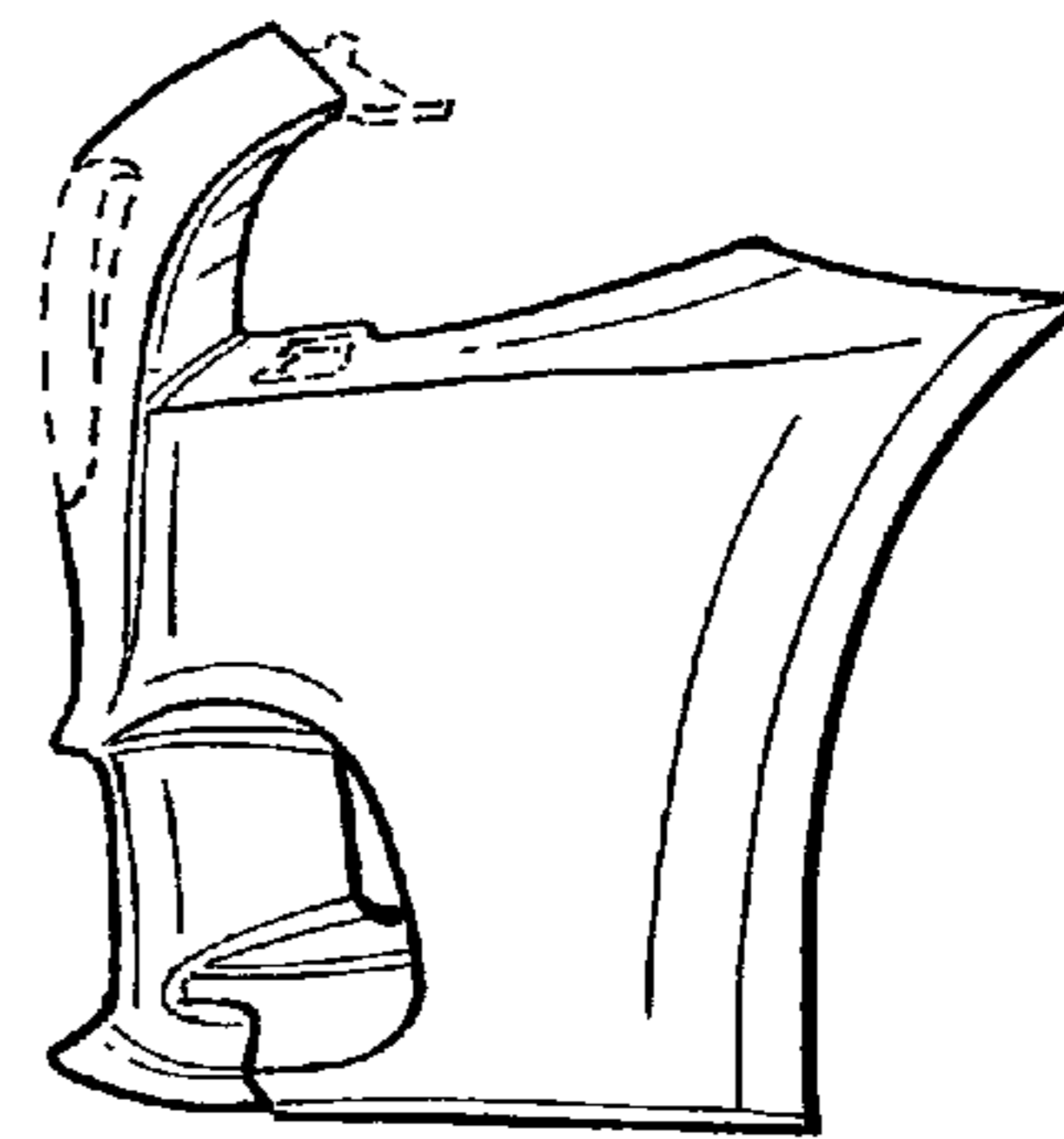

FIG. 5

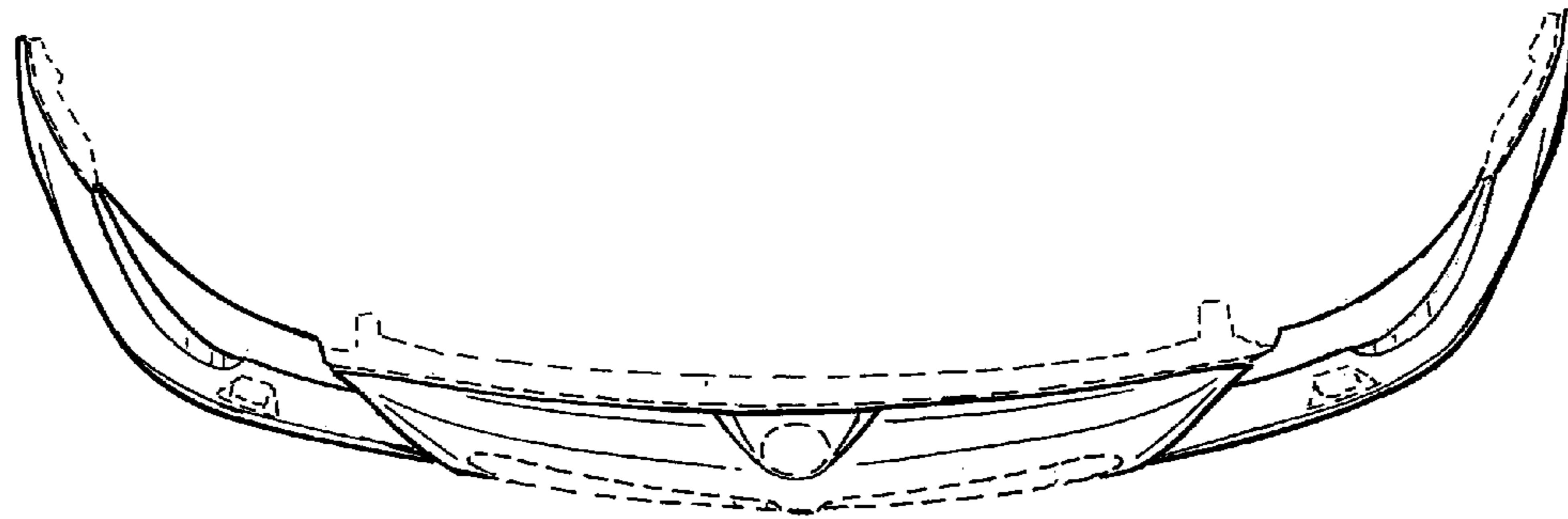

FIG. 6

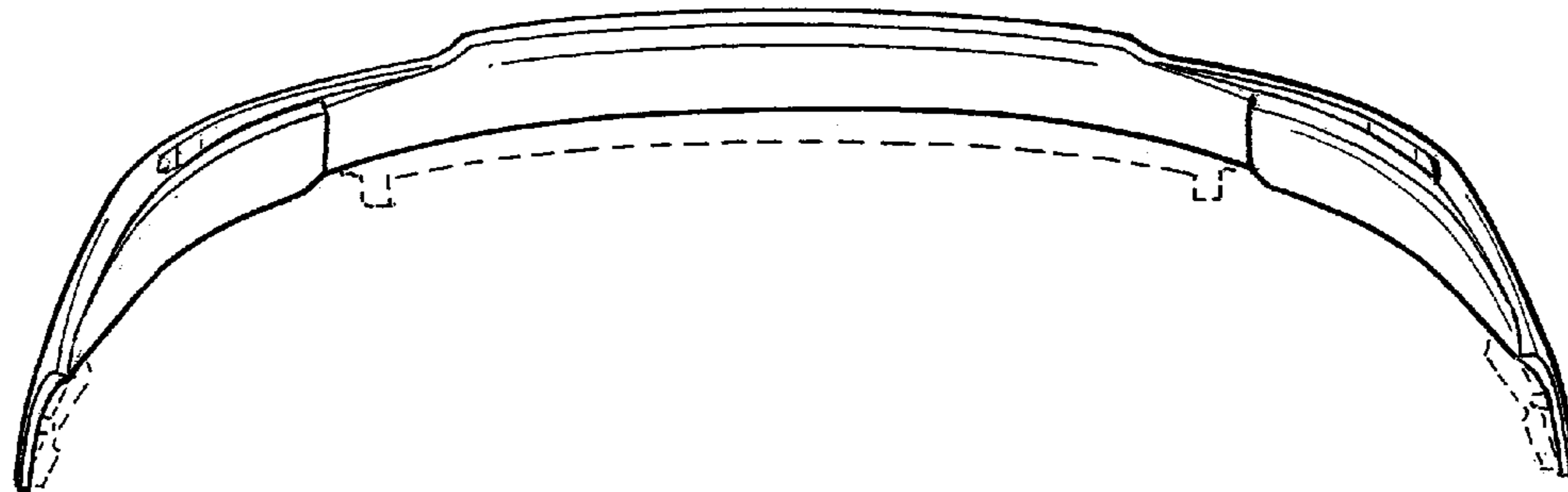

FIG. 7