

US00D669305S

(12) **United States Design Patent**  
**Smyers**

(10) **Patent No.:** **US D669,305 S**

(45) **Date of Patent:** **\*\* Oct. 23, 2012**

(54) **LID FOR FOOD STORAGE VESSELS**

(74) *Attorney, Agent, or Firm* — Larry K. Roberts

(75) Inventor: **Justin Smyers**, Newport Beach, CA  
(US)

(57) **CLAIM**  
The ornamental design for a lid for food storage vessels, as shown and described.

(73) Assignee: **Snapware Corporation**, Mira Loma, CA (US)

**DESCRIPTION**

(\*\*) Term: **14 Years**

This application claims priority under 35 USC Section 120 from application Ser. No. 29/366,916, filed Jul. 30, 2010, the entire contents of which are incorporated by reference herein. FIG. 1 is an isometric view of an embodiment of the design; FIG. 2 is a right side elevation view of the embodiment of FIG. 1, the left side elevation view being identical to the right side elevation view.

(21) Appl. No.: **29/367,143**

(22) Filed: **Aug. 3, 2010**

(51) **LOC (9) Cl.** ..... **07-02**

(52) **U.S. Cl.** ..... **D7/392**

(58) **Field of Classification Search** ..... D7/391–392.1, D7/396.2, 510–511, 541, 629; D9/440, 444, D9/447, 449–150, 454, 503, 504; D3/273, D3/282, 302; 215/211, 200, 224, 243; 220/214, 220/324, 326, 711, 715, 719, 784

See application file for complete search history.

FIG. 3 is a front elevation view of the embodiment of FIG. 1, the back elevation view being identical to the front elevation view; FIG. 4 is a top view of the embodiment of FIG. 1; FIG. 5 is a bottom view of the embodiment of FIG. 1; FIG. 6 is an isometric view of another embodiment of the design; FIG. 7 is a right side elevation view of the embodiment of FIG. 6, the left side elevation view being identical to the right side elevation view.

(56) **References Cited**

**U.S. PATENT DOCUMENTS**

4,625,885	A *	12/1986	Nichols	.....	220/214
D356,256	S *	3/1995	Romanoff	.....	D3/282
D452,374	S *	12/2001	Kim	.....	D3/302
D455,321	S *	4/2002	Jung et al.	.....	D7/629
D481,910	S *	11/2003	Kim	.....	D7/629
D483,622	S *	12/2003	Kim	.....	D7/629
D484,367	S *	12/2003	Kim	.....	D7/629
D490,277	S *	5/2004	Kim	.....	D7/629
D493,073	S *	7/2004	Kim	.....	D7/629
D500,227	S *	12/2004	Seok	.....	D7/392.1
D516,376	S *	3/2006	Kim	.....	D7/392.1
D528,357	S *	9/2006	Hsu	.....	D7/392.1
D536,571	S *	2/2007	Kim	.....	D7/391
D549,519	S *	8/2007	Moon et al.	.....	D7/391
D556,517	S *	12/2007	Lown et al.	.....	D7/629
D562,083	S *	2/2008	Lown et al.	.....	D7/629
D610,878	S *	3/2010	Kim	.....	D7/629
D610,879	S *	3/2010	Kim	.....	D7/629
D615,821	S *	5/2010	Stamper	.....	D7/541
2004/0084464	A1 *	5/2004	Koo	.....	220/784
2005/0035125	A1 *	2/2005	Bae	.....	220/326

\* cited by examiner

*Primary Examiner* — Cytnhia M Chin

FIG. 8 is a front elevation view of the embodiment of FIG. 6, the back elevation view being identical to the front elevation view; FIG. 9 is a top view of the embodiment of FIG. 6; FIG. 10 is a bottom view of the embodiment of FIG. 6; FIG. 11 is an isometric view of another embodiment of the design; FIG. 12 is a right side elevation view of the embodiment of FIG. 11, the left side elevation view being identical to the right side elevation view. FIG. 13 is a front elevation view of the embodiment of FIG. 11, the back elevation view being identical to the front elevation view; FIG. 14 is a top view of the embodiment of FIG. 11; FIG. 15 is a bottom view of the embodiment of FIG. 11; FIG. 16 is an isometric view of another embodiment of the design; FIG. 17 is a right side elevation view of the embodiment of FIG. 16, the left side elevation view being identical to the right side elevation view.

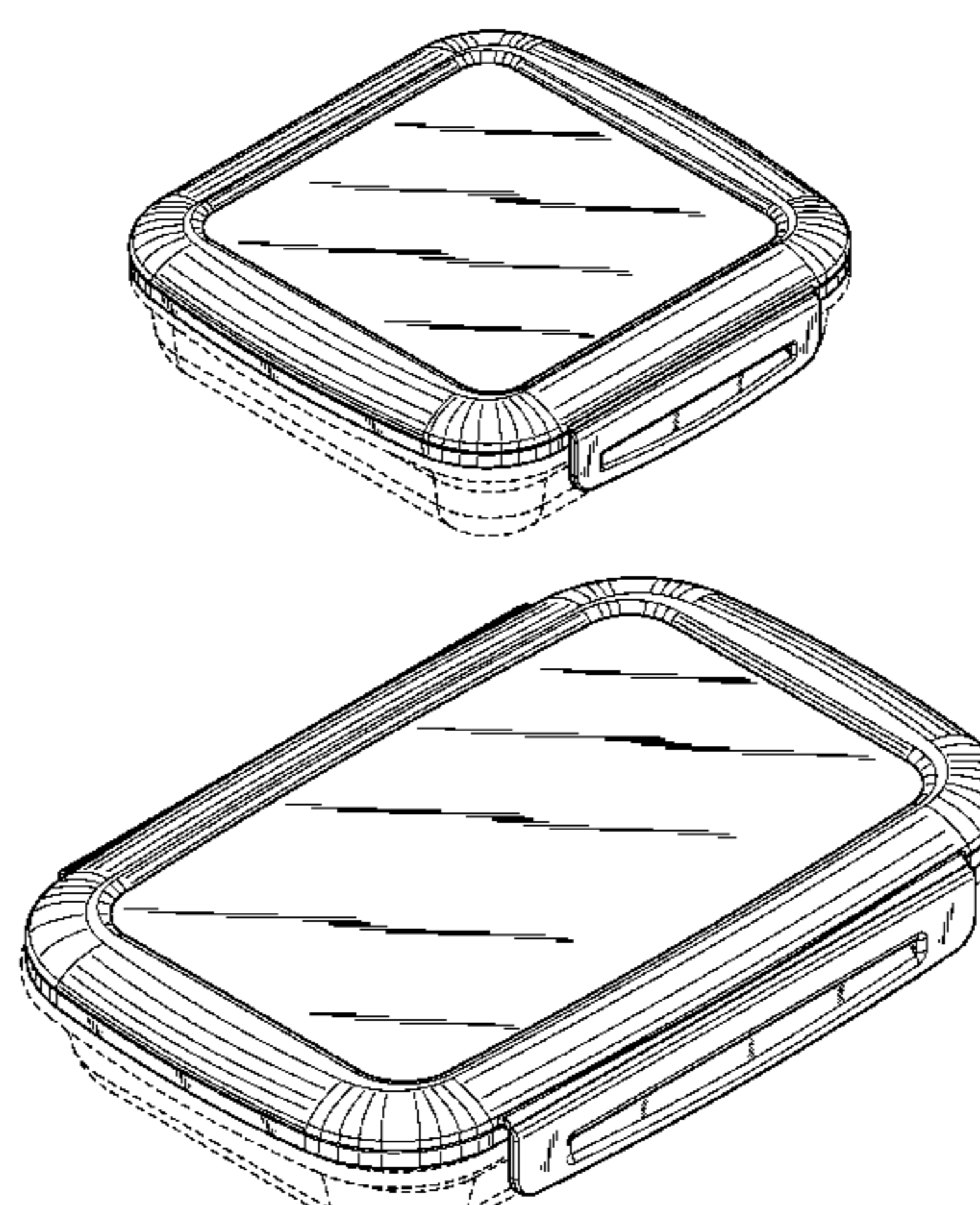

FIG. **18** is a front elevation view of the embodiment of FIG. **16**, the back elevation view being identical to the front elevation view;

FIG. **19** is a top view of the embodiment of FIG. **16**;

FIG. **20** is a bottom view of the embodiment of FIG. **16**;

FIG. **21** is an isometric view of another embodiment of the design;

FIG. **22** is a right side elevation view of the embodiment of FIG. **21**, the left side elevation view being identical to the right side elevation view.

FIG. **23** is a front elevation view of the embodiment of FIG. **21**, the back elevation view being identical to the front elevation view;

FIG. **24** is a top view of the embodiment of FIG. **21**;

FIG. **25** is a bottom view of the embodiment of FIG. **21**;

FIG. **26** is an isometric view of another embodiment of the design;

FIG. **27** is a right side elevation view of the embodiment of FIG. **26**, the left side elevation view being identical to the right side elevation view.

FIG. **28** is a front elevation view of the embodiment of FIG. **26**, the back elevation view being identical to the front elevation view;

FIG. **29** is a top view of the embodiment of FIG. **26**; and,

FIG. **30** is a bottom view of the embodiment of FIG. **26**.

The broken lines immediately adjacent the shaded areas represent the bounds of the claim and all other broken lines represent unclaimed portions of the design. None of the broken lines form a part of the claimed design.

**1 Claim, 24 Drawing Sheets**

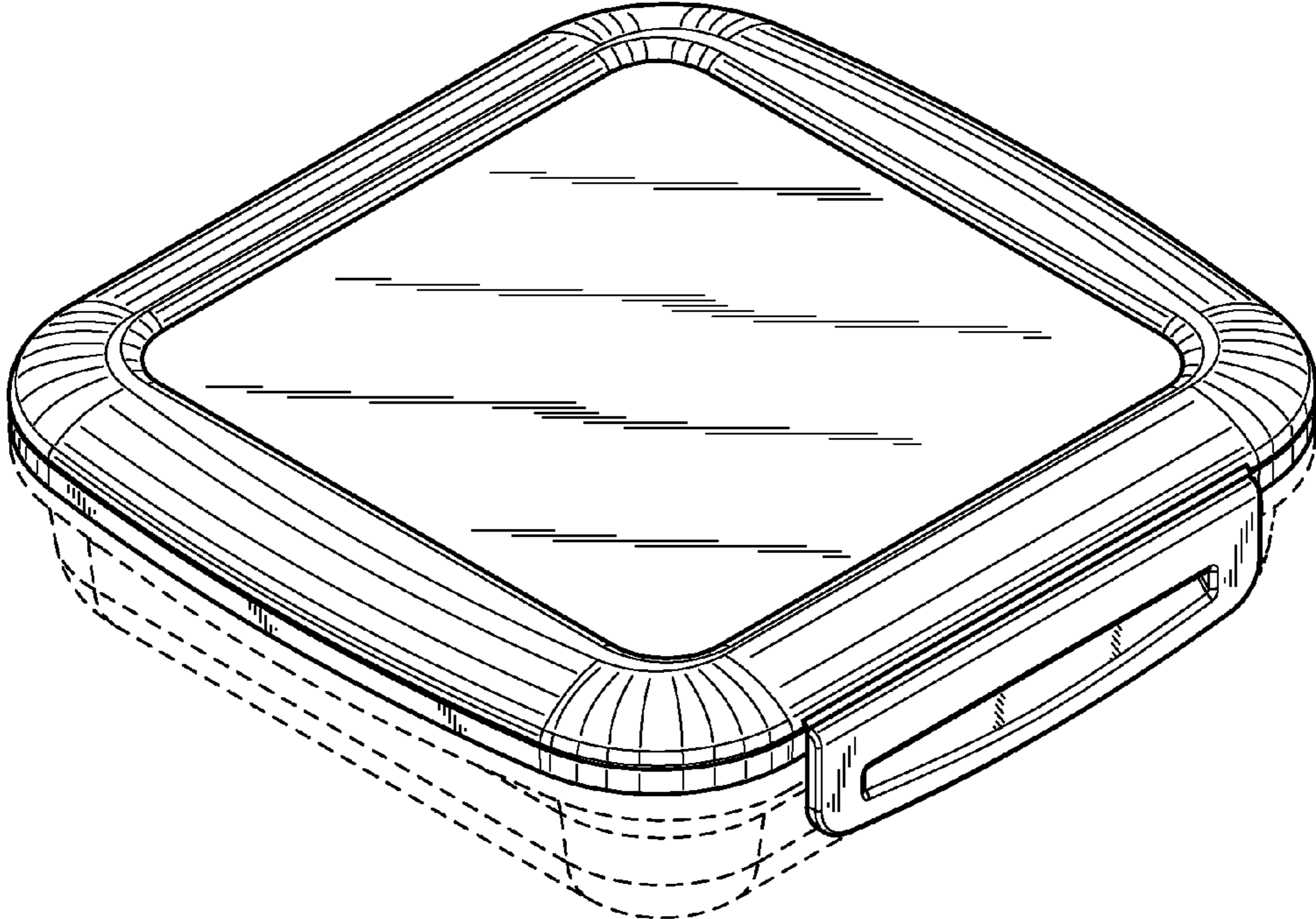

FIG. 1

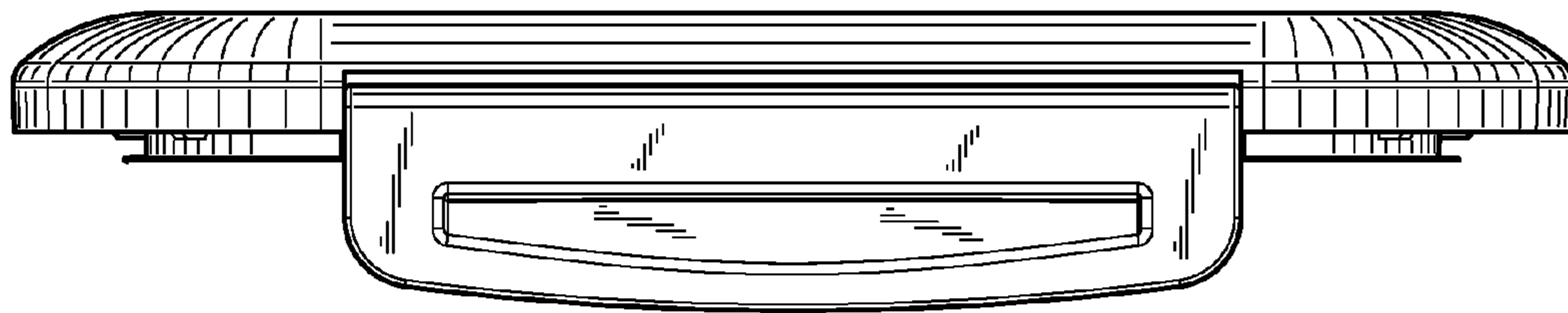

FIG. 2

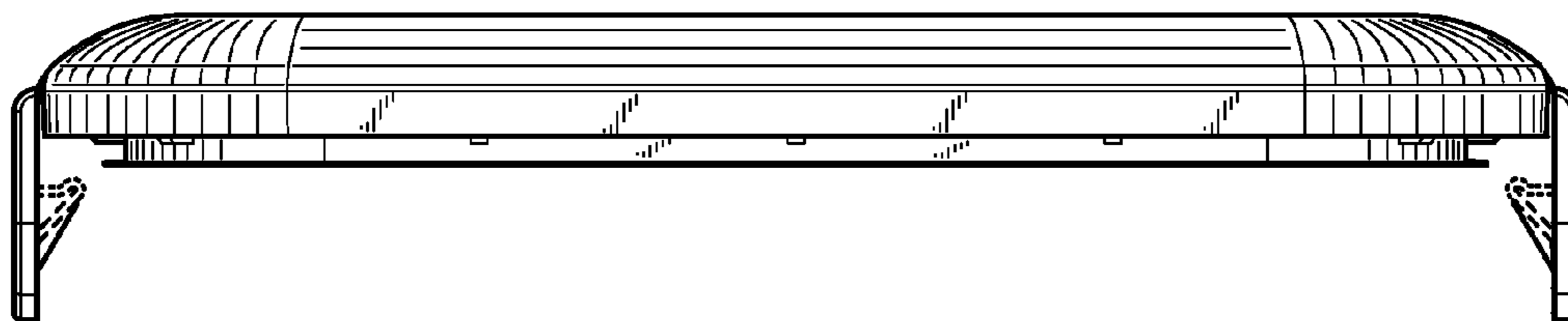

FIG. 3

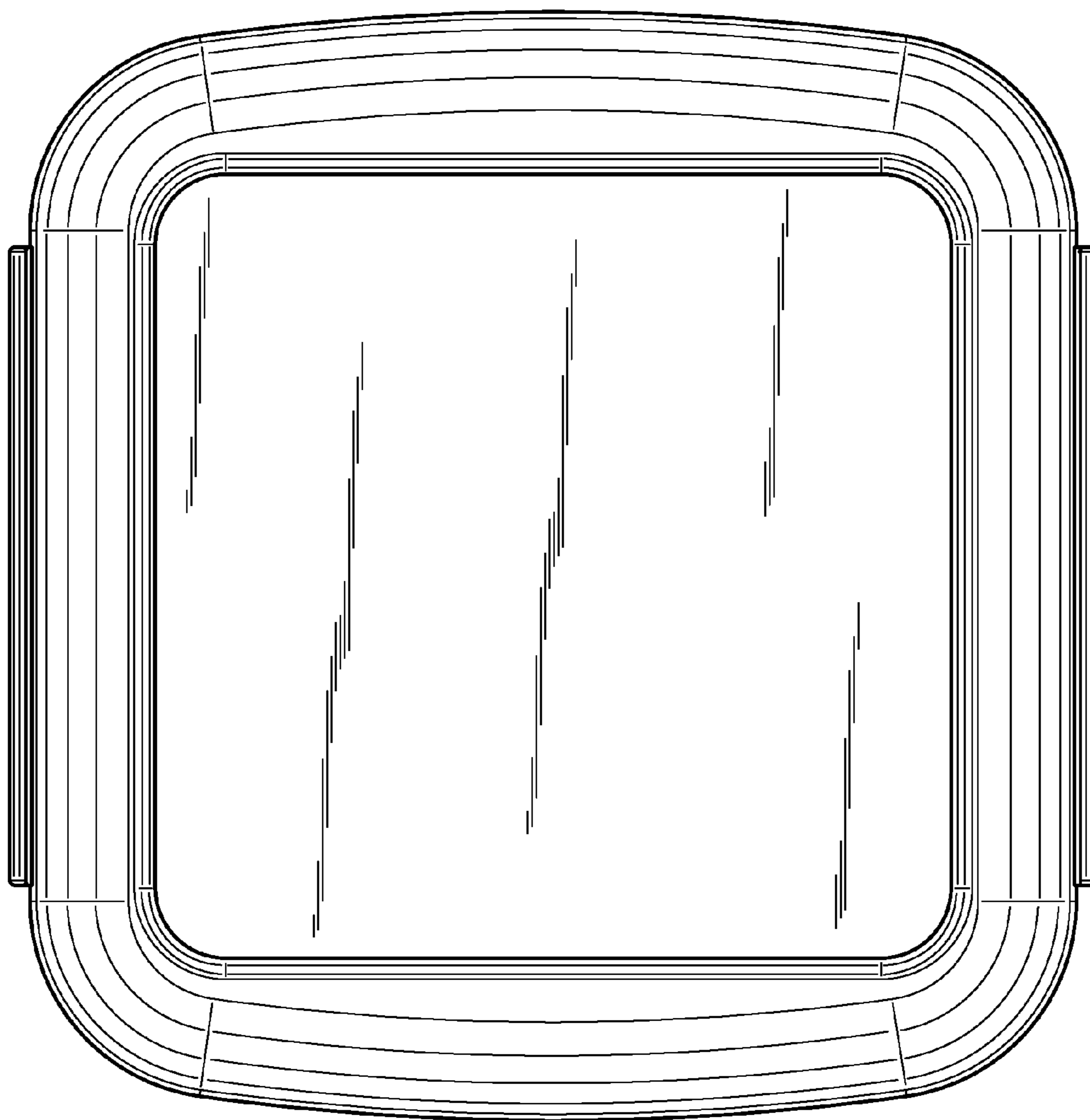

FIG. 4

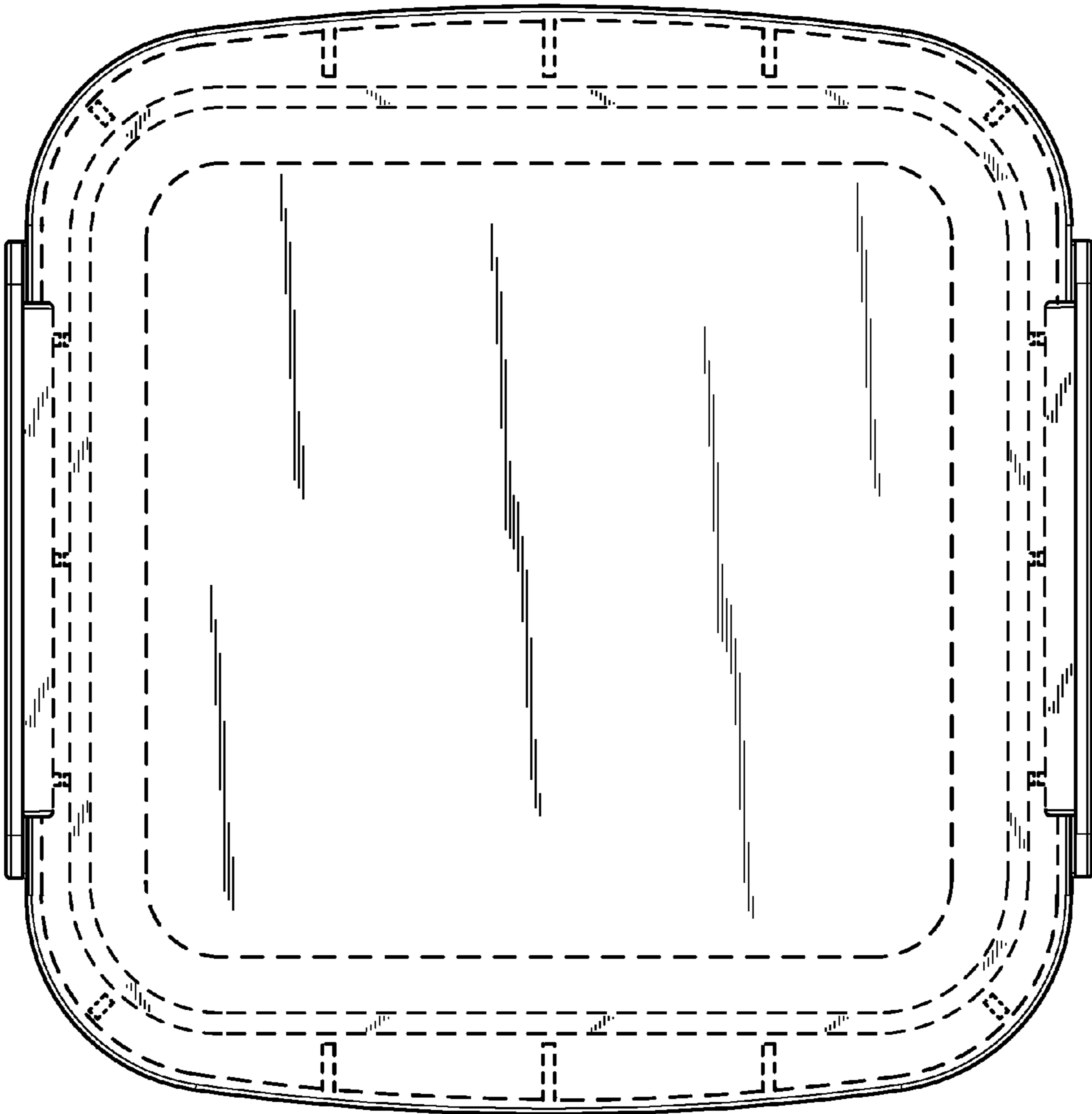

FIG. 5

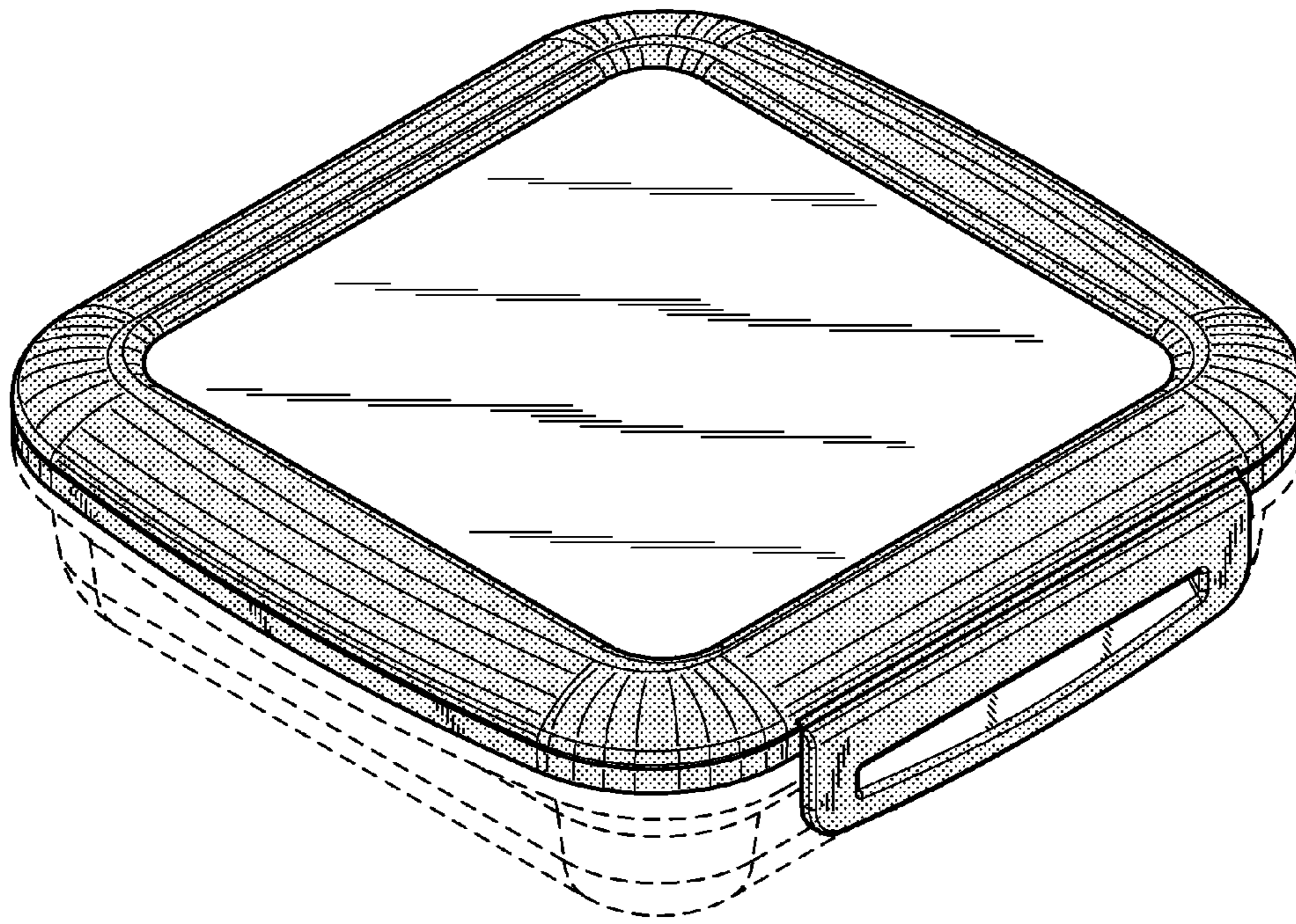

FIG. 6

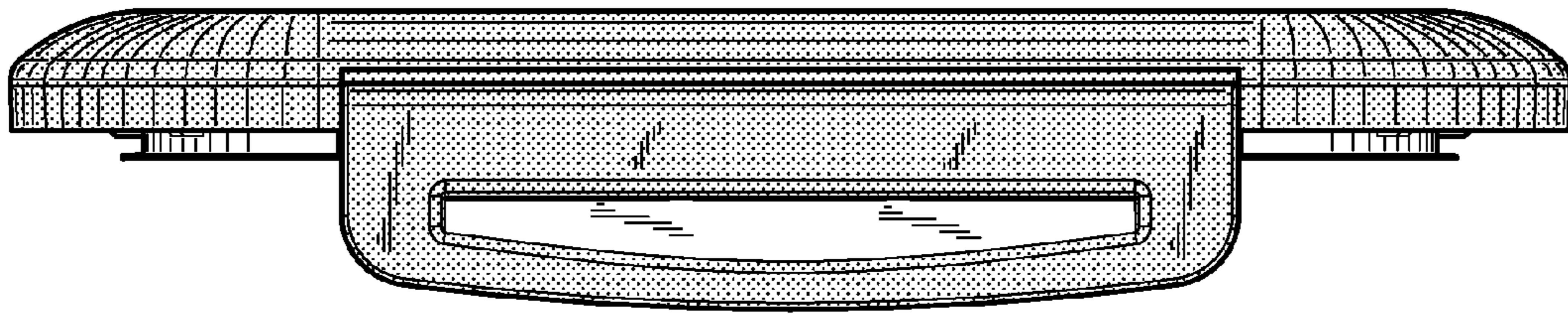

FIG. 7

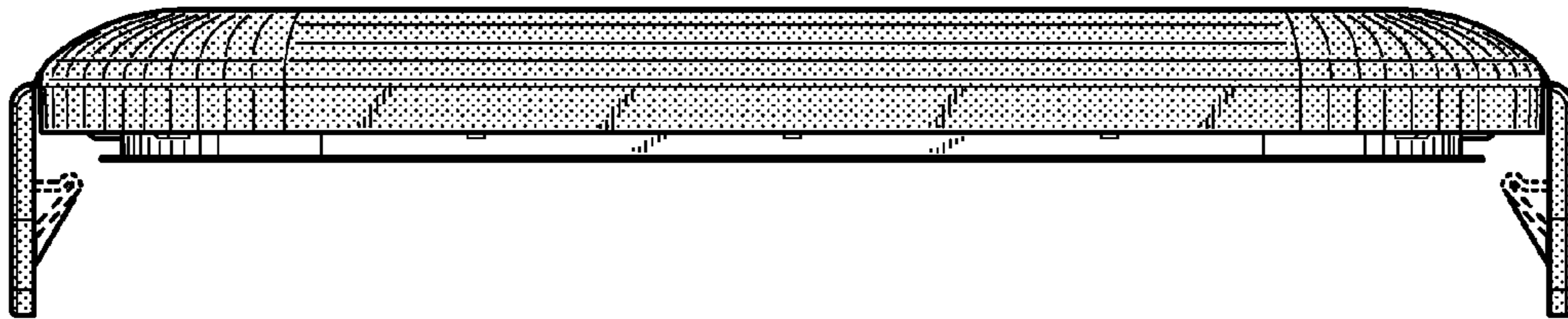

FIG. 8



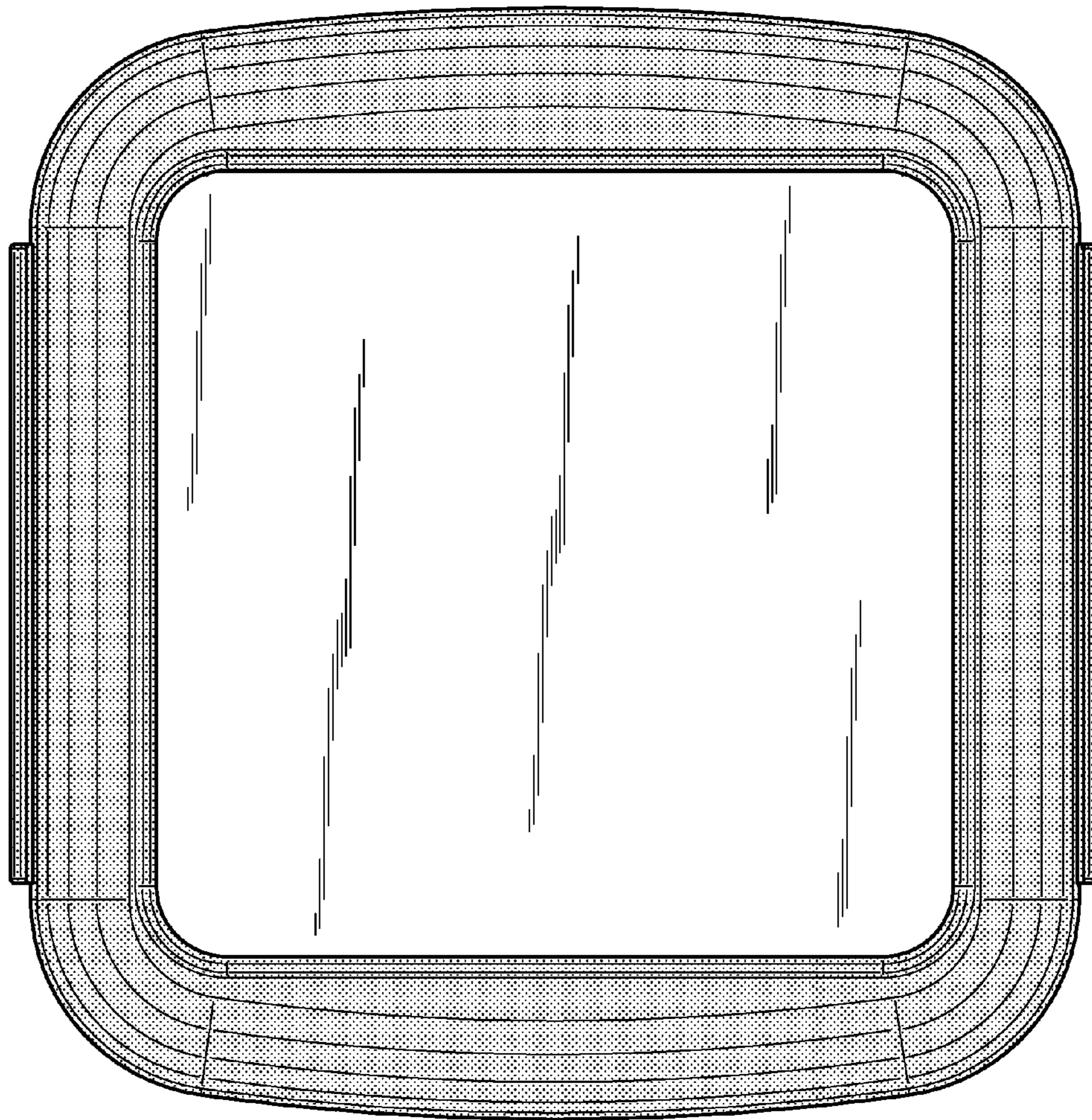

FIG. 9

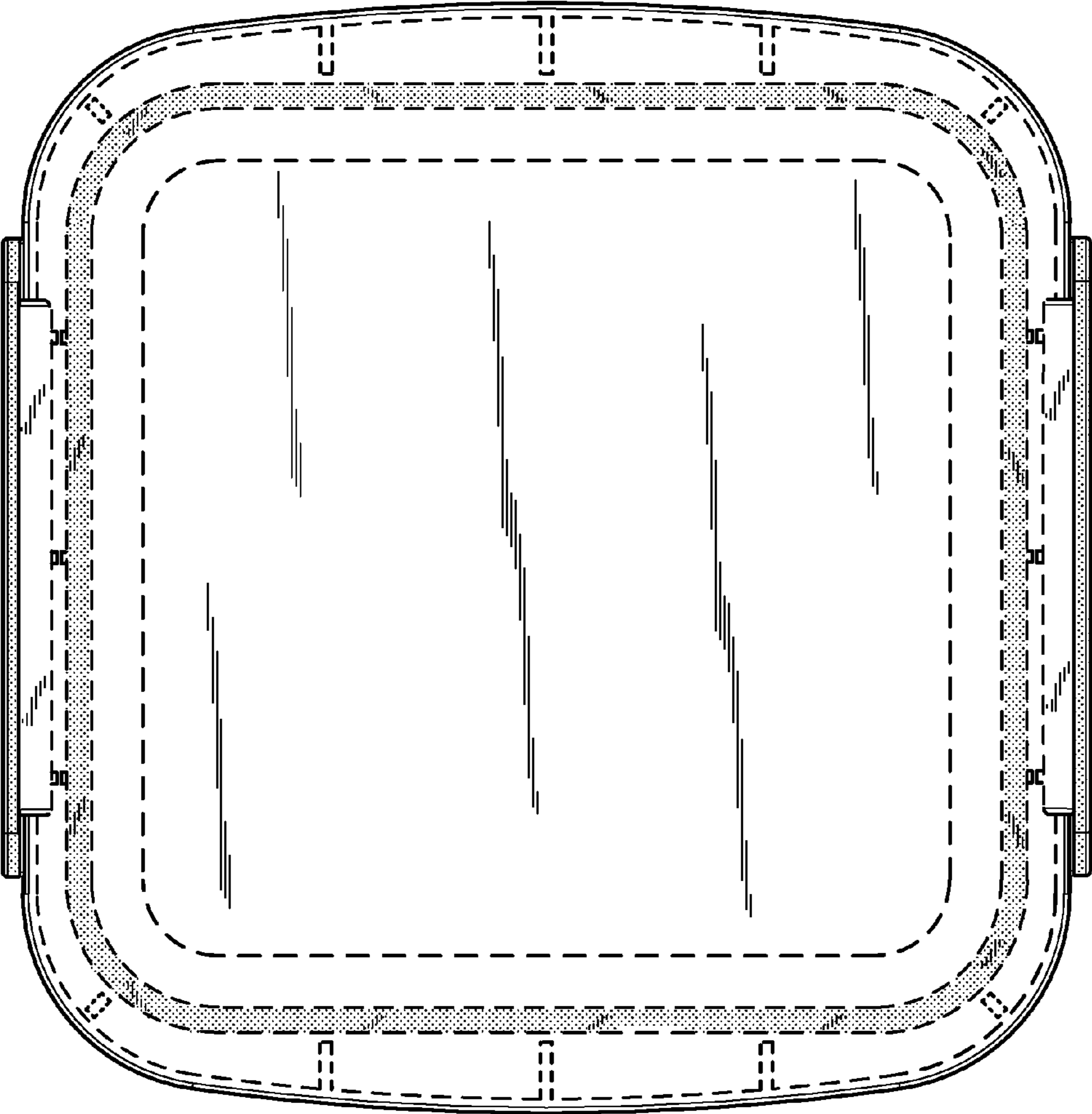

FIG. 10

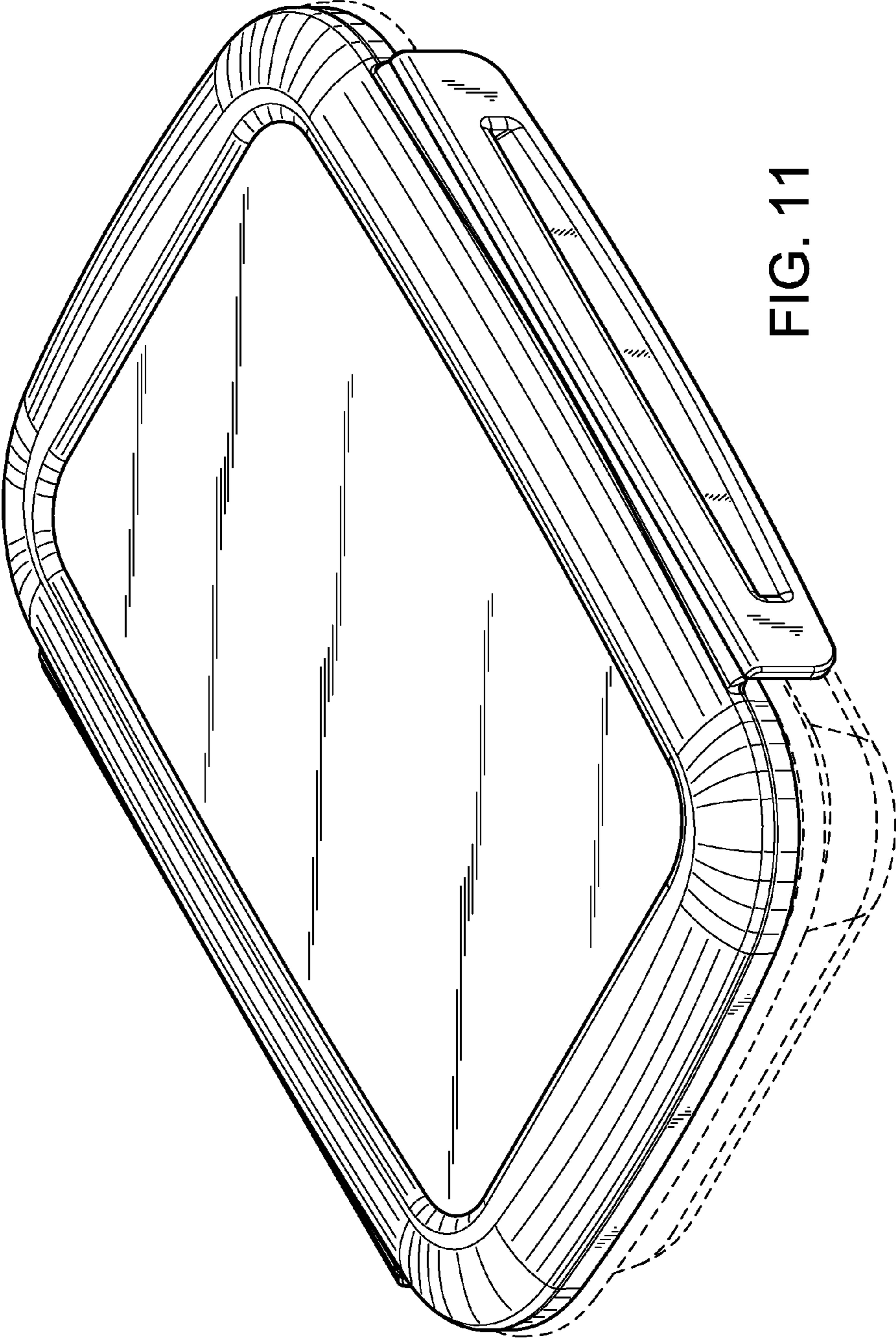

FIG. 11

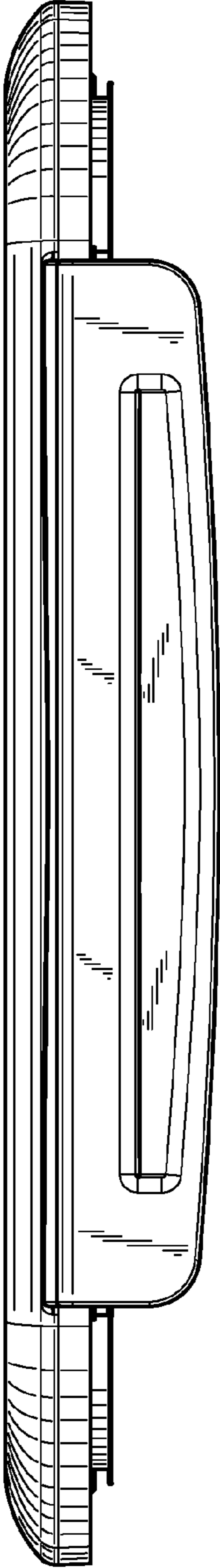

FIG. 12



FIG. 13

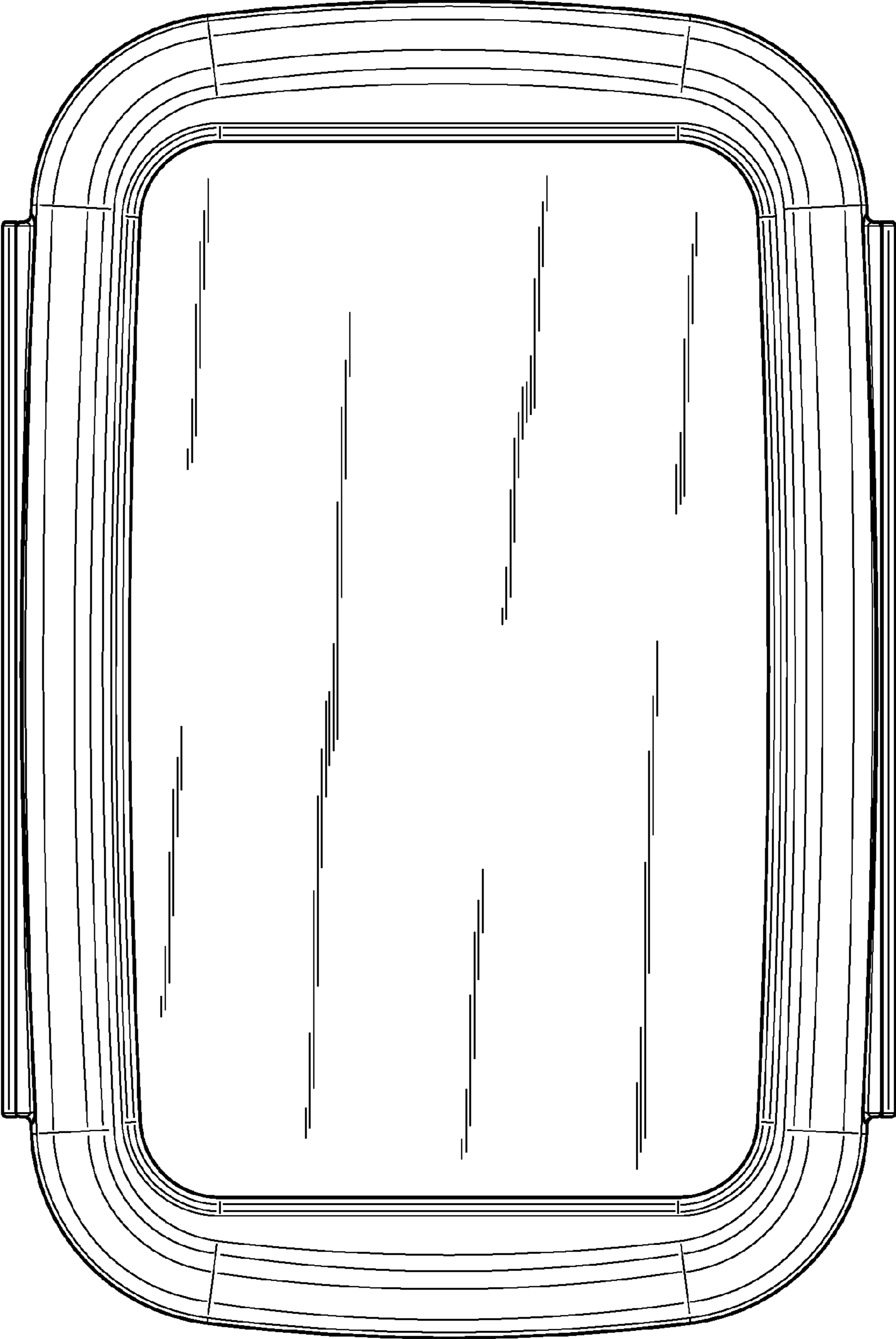

FIG. 14

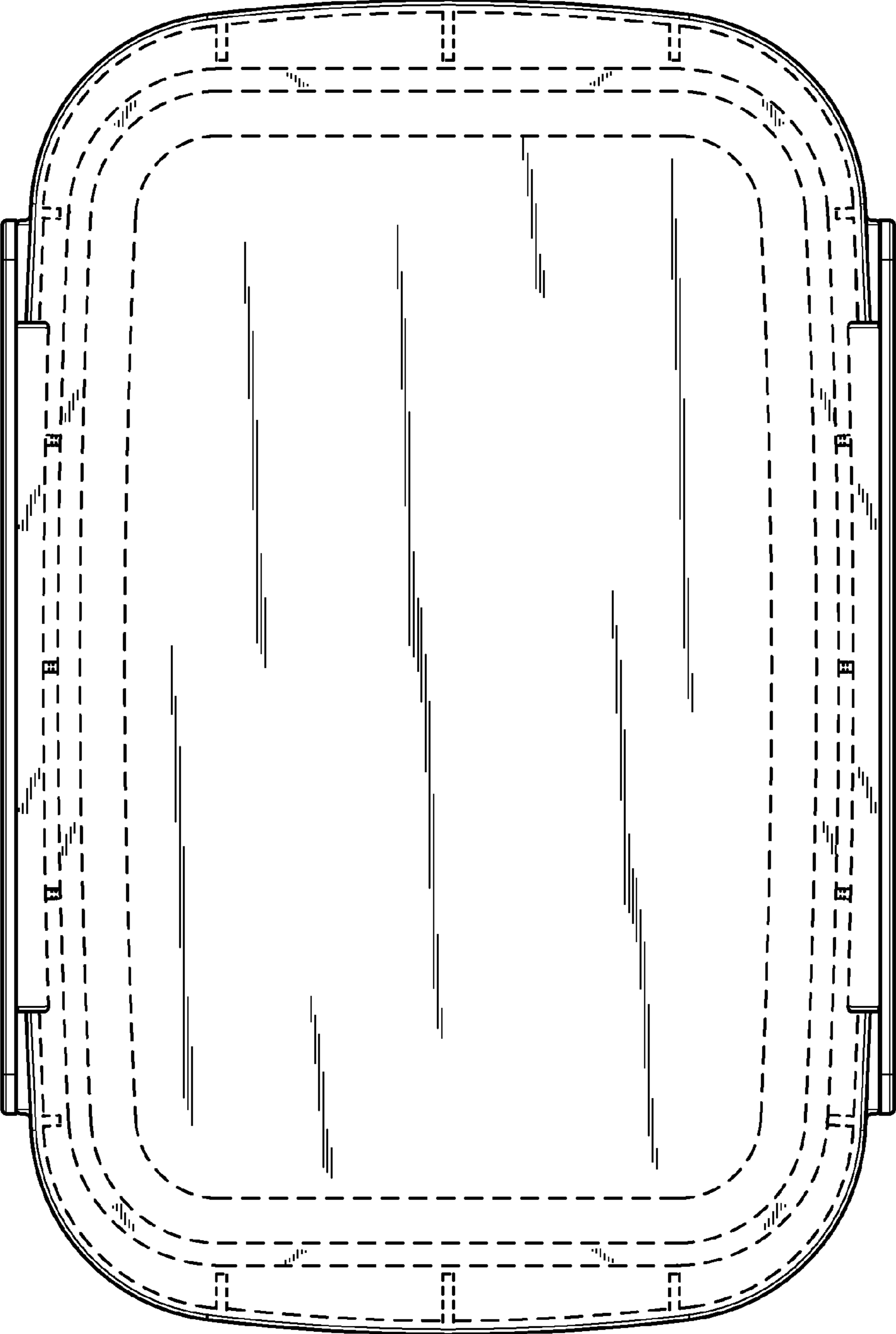

FIG. 15

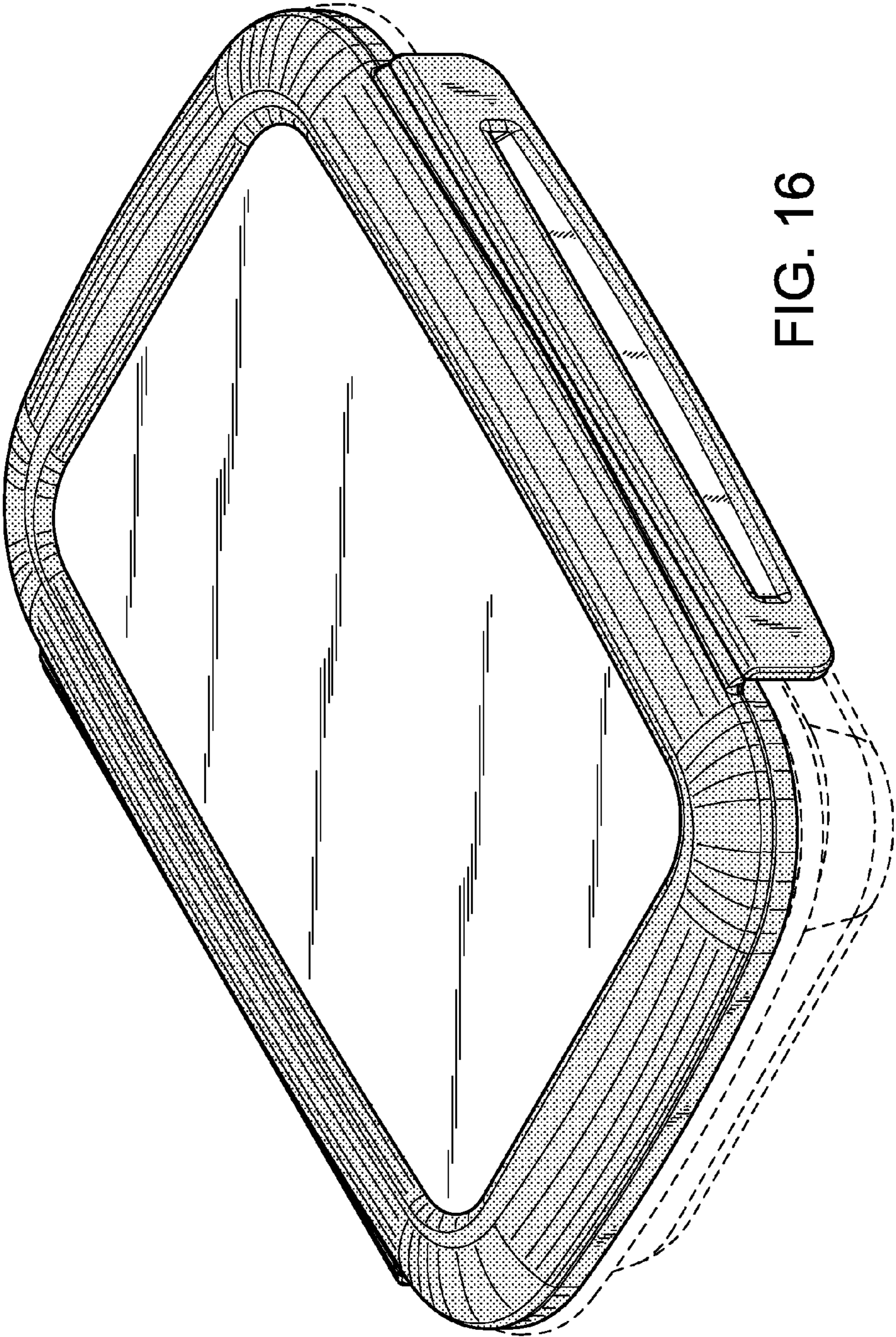

FIG. 16

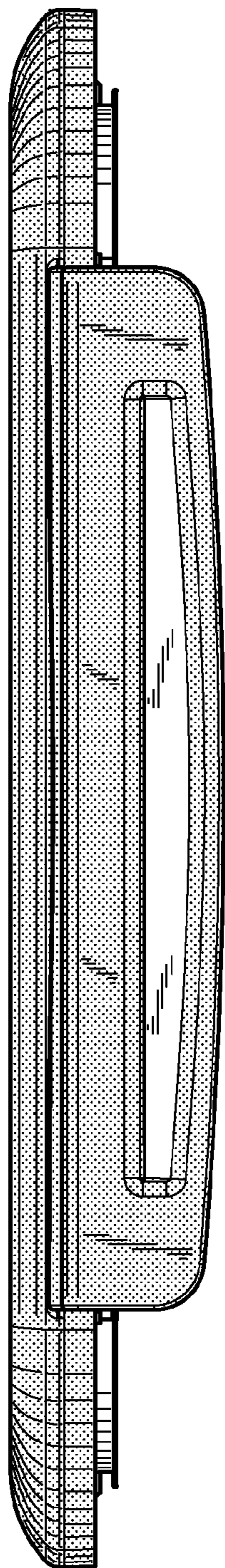

FIG. 17

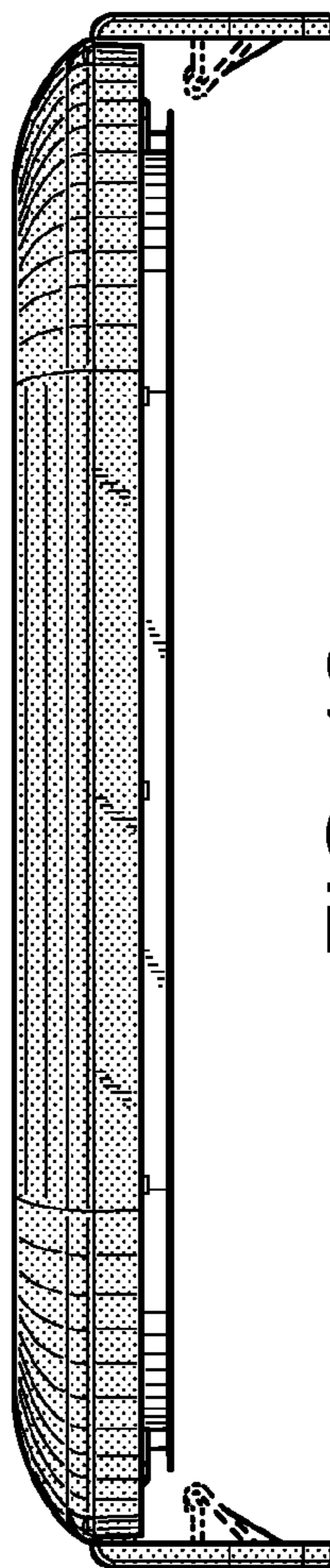

FIG. 18



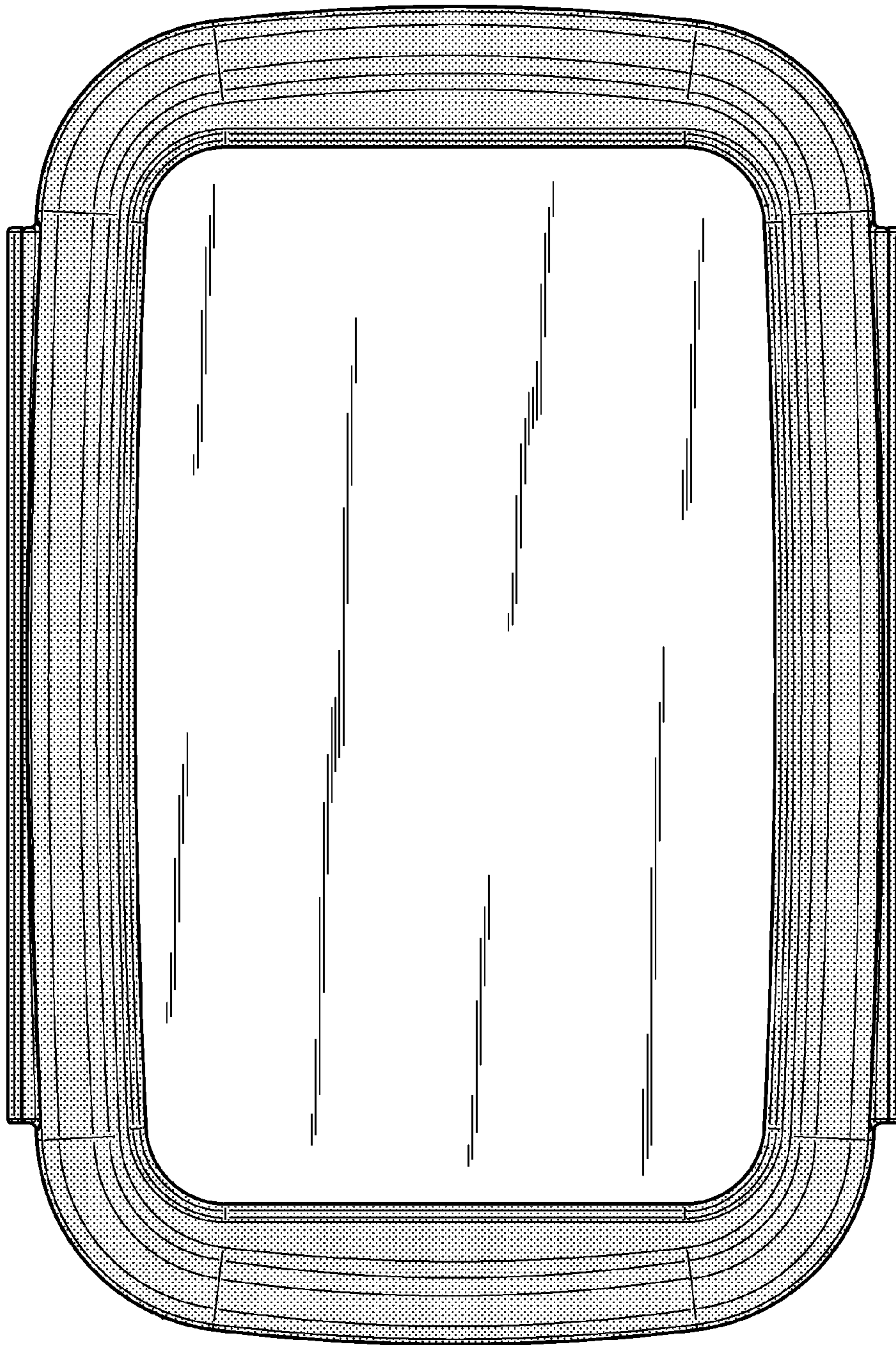

FIG. 19

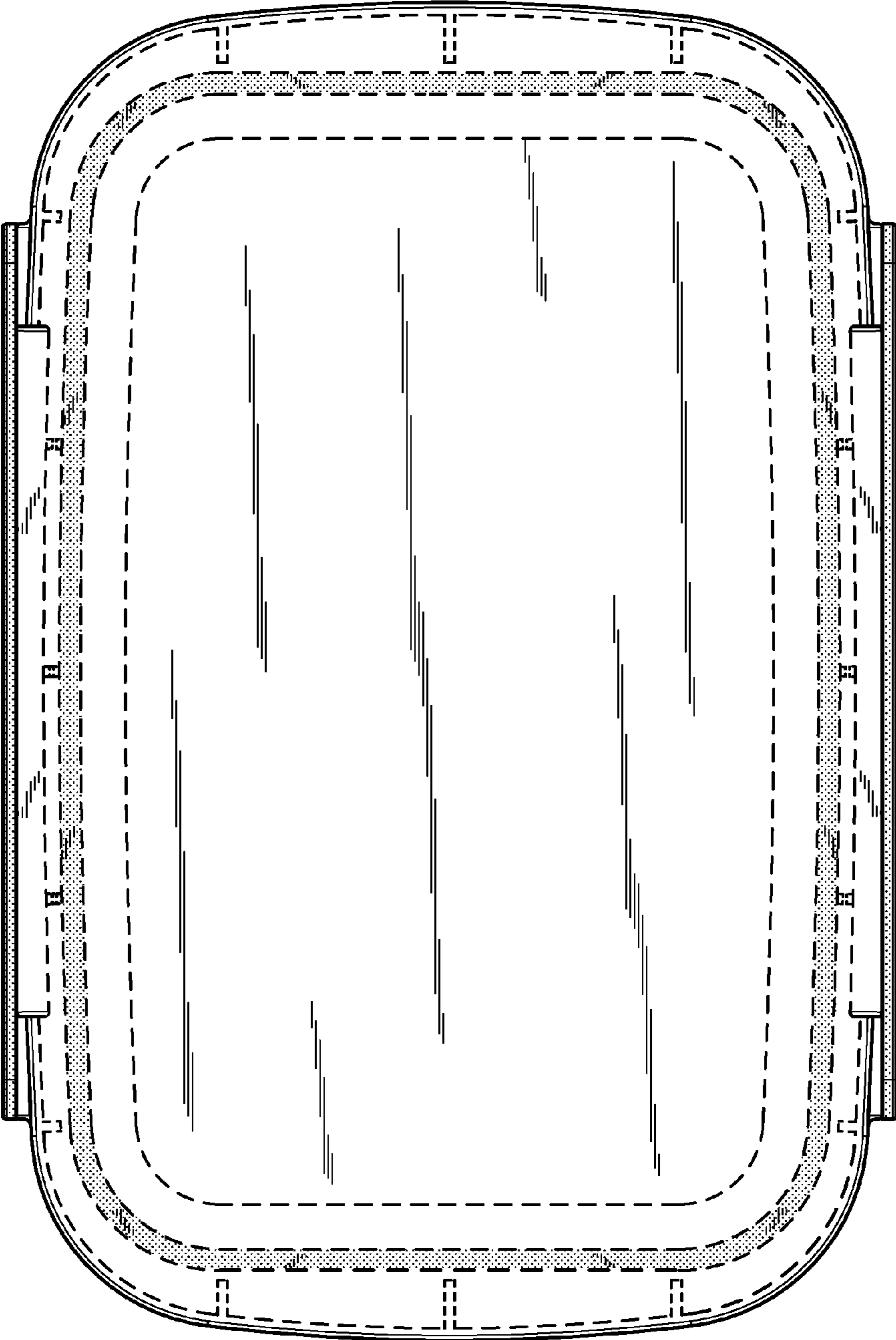

FIG. 20

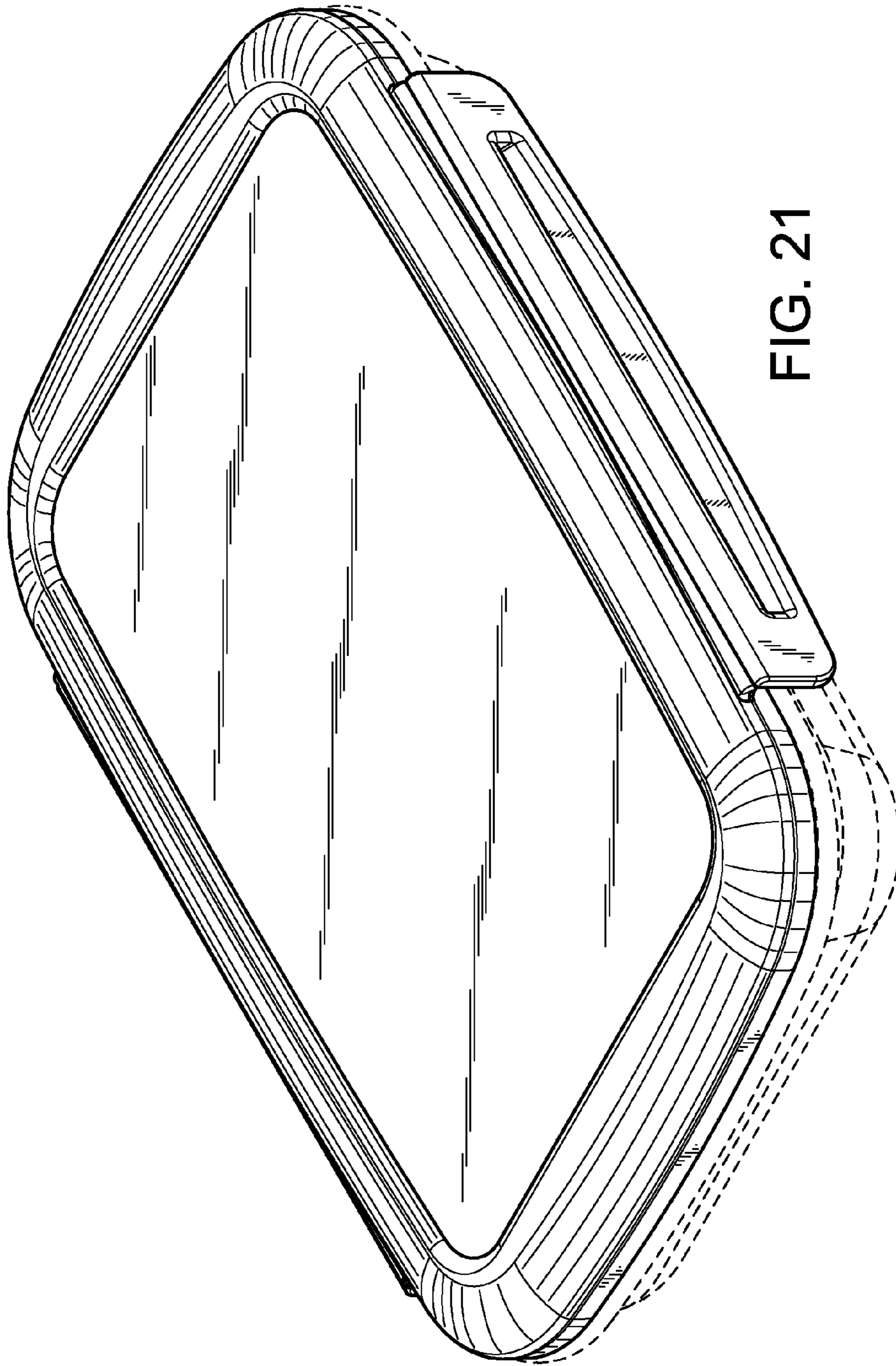

FIG. 21

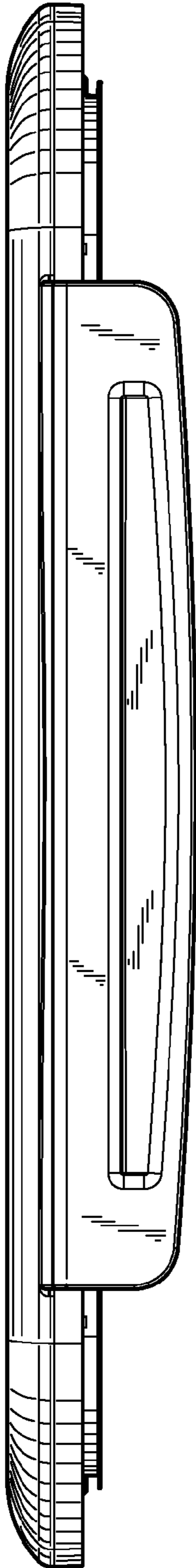

FIG. 22

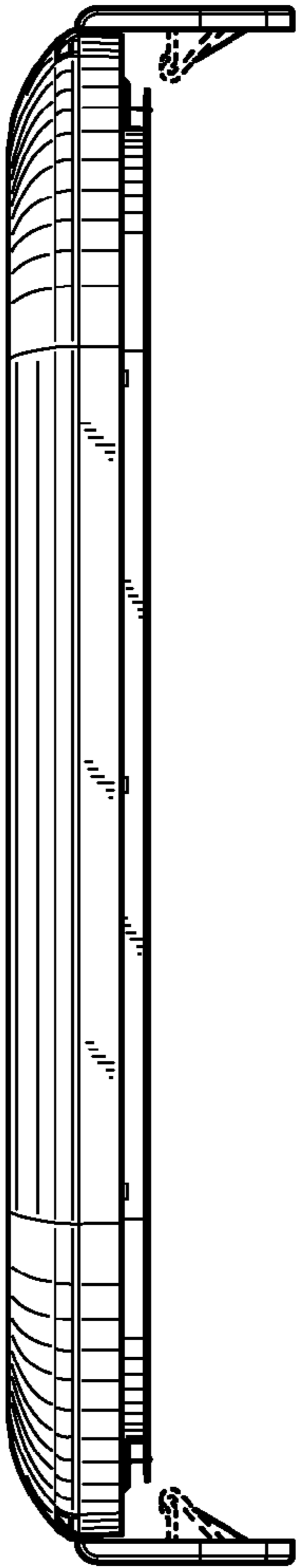

FIG. 23

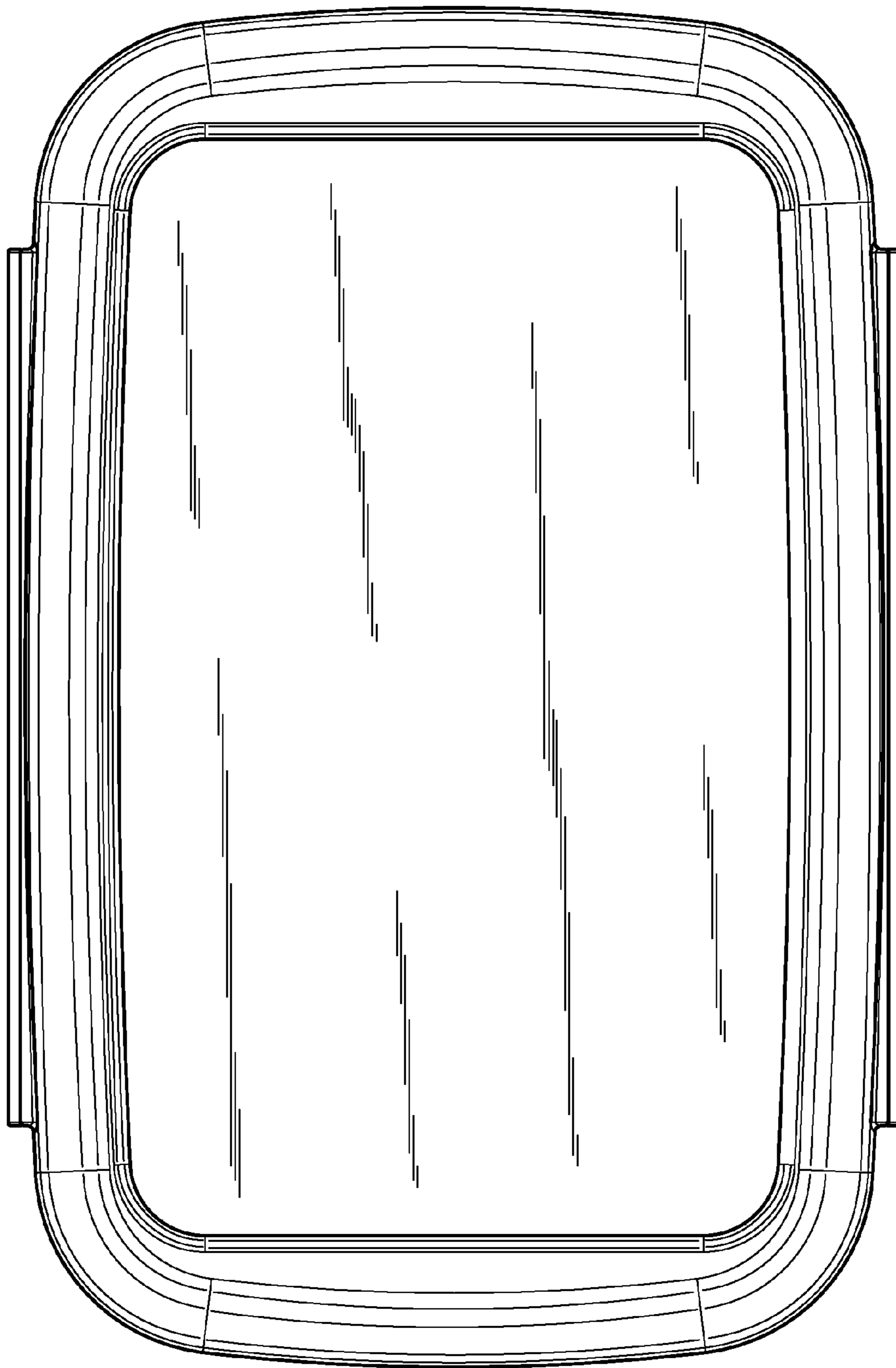

FIG. 24

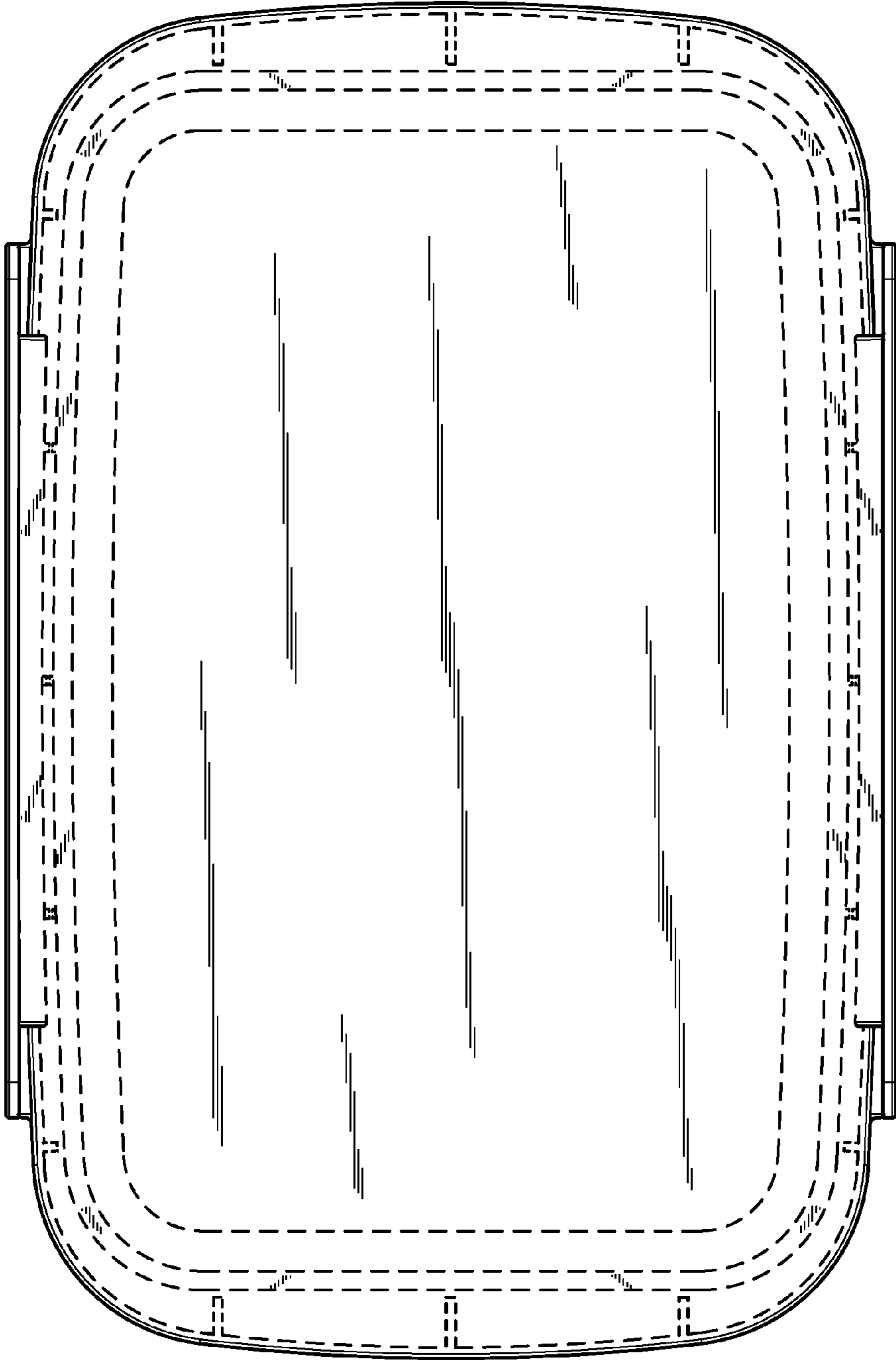

FIG. 25

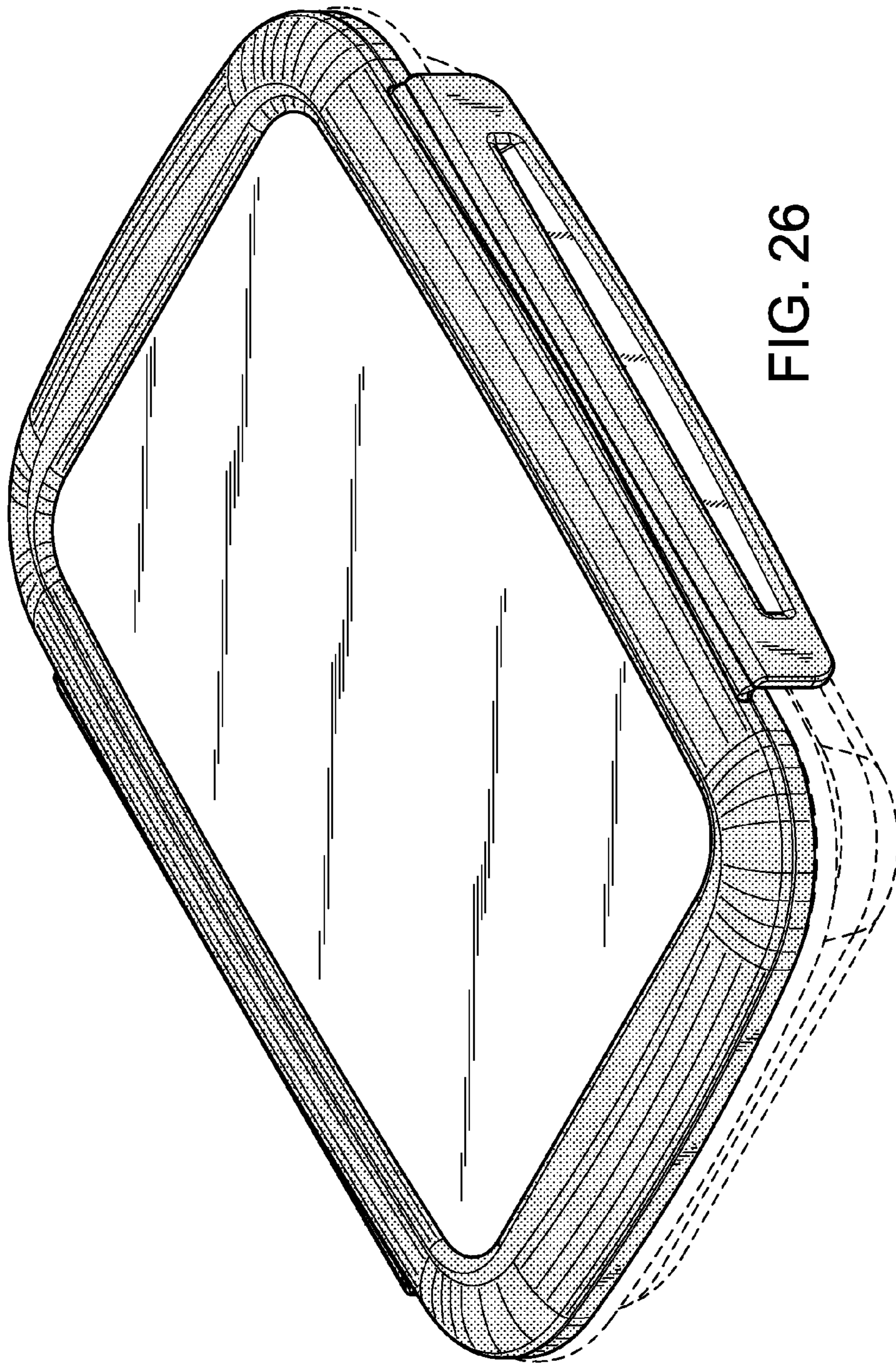

FIG. 26

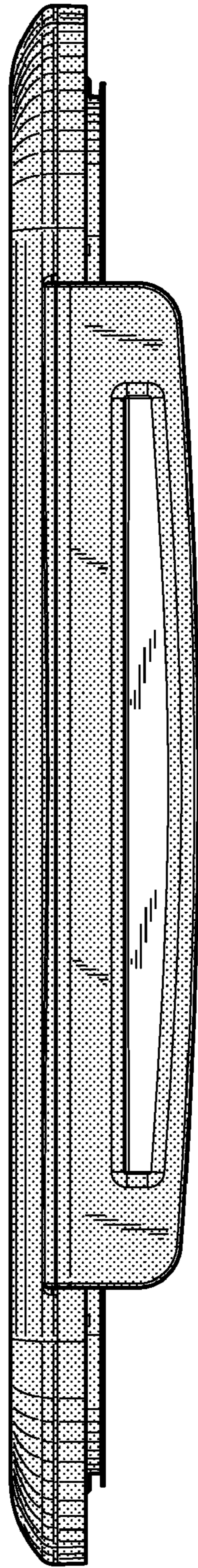

FIG. 27

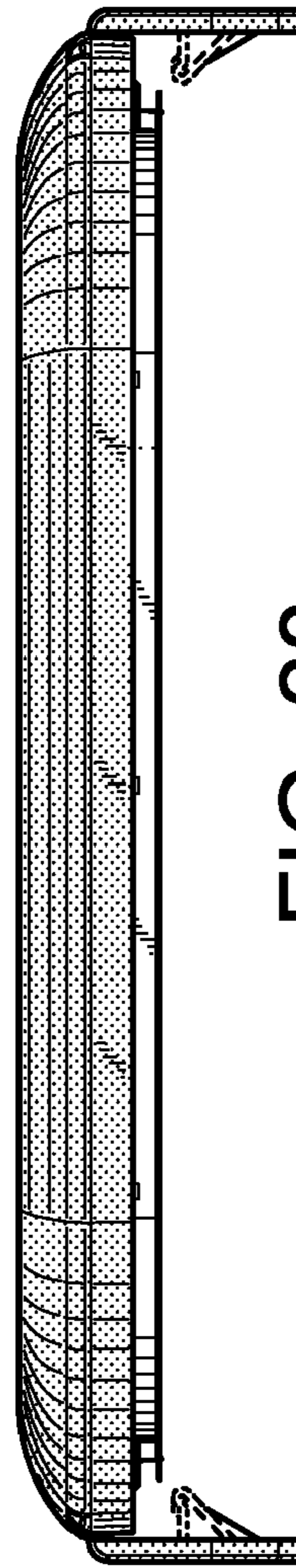

FIG. 28



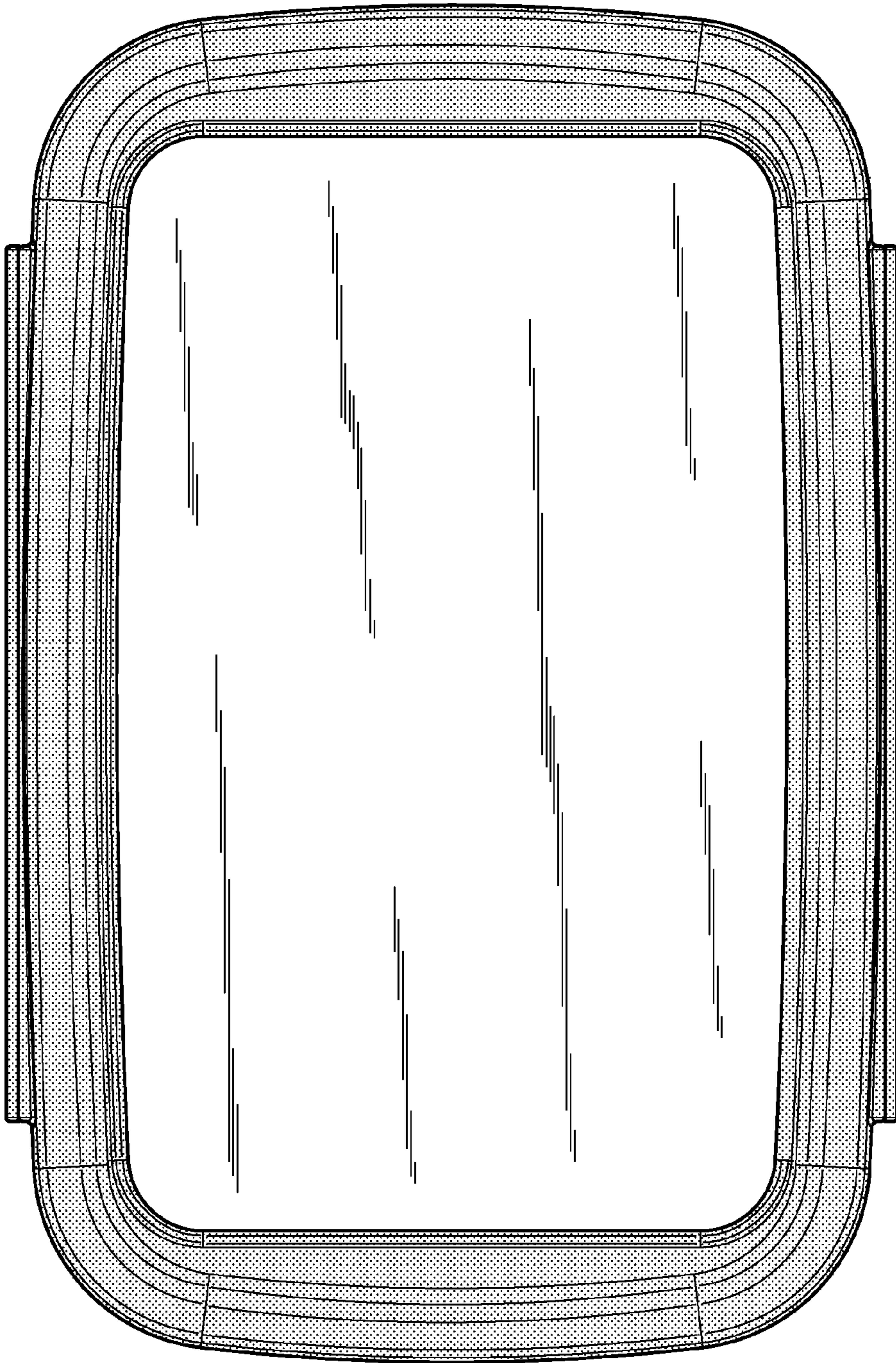

FIG. 29

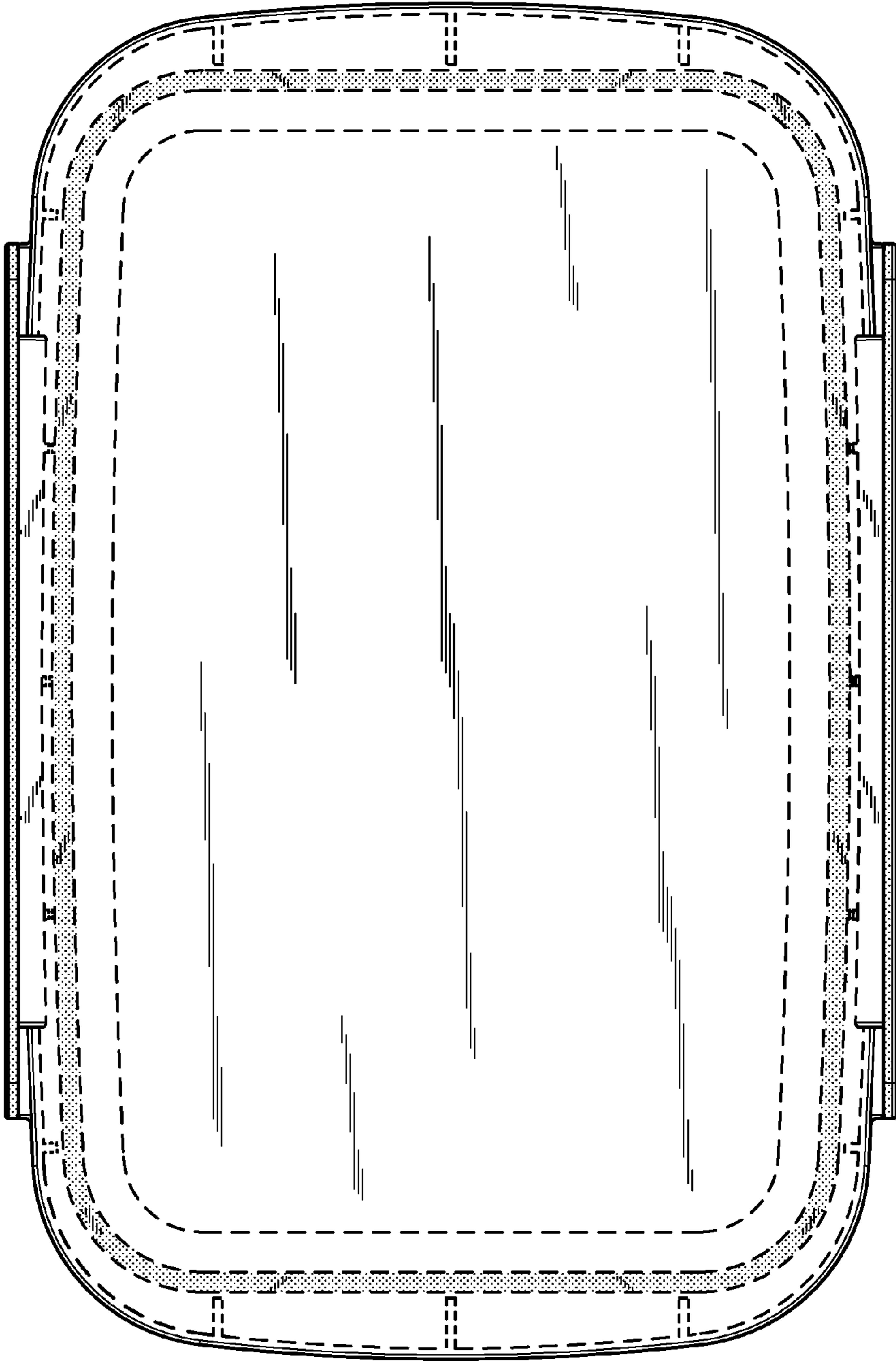

FIG. 30