



US00D669213S

(12) **United States Design Patent**
Celia

(10) **Patent No.:** **US D669,213 S**

(45) **Date of Patent:** **** *Oct. 16, 2012**

(54) **WEDGE SHAPED APPLICATOR**

(75) Inventor: **Wayne Celia**, Woonsocket, RI (US)

(73) Assignee: **Diversified Global Technologies, LLC**,
Woonsocket, RI (US)

(*) Notice: This patent is subject to a terminal disclaimer.

(**) Term: **14 Years**

(21) Appl. No.: **29/391,267**

(22) Filed: **May 5, 2011**

(51) **LOC (9) Cl.** **28-02**

(52) **U.S. Cl.** **D28/7**

(58) **Field of Classification Search** D28/7,
D28/8, 20–22, 30–31, 76, 85, 99; 132/108,
132/202, 208, 317, 320; 401/202–207, 261–267;
D4/132–135; D24/119; 15/104.94, 209.1,
15/210.1; 601/138; D32/40, 52
See application file for complete search history.

(56) **References Cited**

U.S. PATENT DOCUMENTS

3,291,130	A *	12/1966	Whitehead	604/369
D206,641	S *	1/1967	Hill	D24/124
3,472,242	A *	10/1969	Demner	132/333
3,648,319	A *	3/1972	Mitchell	15/118
6,601,591	B1 *	8/2003	Carullo et al.	132/320
6,735,809	B2 *	5/2004	Parks	15/118
D506,299	S *	6/2005	Chumley	D32/40
D556,966	S *	12/2007	Herbrand et al.	D32/40
D589,665	S *	3/2009	Kwapis	D32/40
D623,371	S *	9/2010	Li	D32/40
D634,495	S *	3/2011	Dunshee et al.	D32/40

* cited by examiner

Primary Examiner — Zenia Bennett

(74) *Attorney, Agent, or Firm* — IP Attorneys Group, LLC

(57) **CLAIM**

The “wedge shaped applicator,” as shown and described.

DESCRIPTION

FIG. 1 is a top perspective view of a wedge shaped applicator in accordance with my new design;

FIG. 2 is a top view thereof;

FIG. 3 is a rear view thereof;

FIG. 4 is a right side view thereof;

FIG. 5 is a left side view thereof;

FIG. 6 is an end view thereof;

FIG. 7 is a top perspective view of one wedge of the wedge shaped applicator in FIG. 1 shown separately for convenience of illustration.

FIG. 8 is a top view of the one wedge shown in FIG. 7;

FIG. 9 is a bottom view of the one wedge shown in FIG. 7;

FIG. 10 is a rear view of the one wedge shown in FIG. 7;

FIG. 11 is a front view of the one wedge shown in FIG. 7;

FIG. 12 is a left side view of the one wedge shown in FIG. 7;

FIG. 13 is a right side view of the one wedge shown in FIG. 7;

FIG. 14 is a top perspective view of one wedge of the wedge shaped applicator in FIG. 1 shown separately for convenience of illustration.

FIG. 15 is a top view of the one wedge shown in FIG. 7;

FIG. 16 is a bottom view of the one wedge shown in FIG. 7;

FIG. 17 is a front view of the one wedge shown in FIG. 7;

FIG. 18 is a rear view of the one wedge shown in FIG. 7;

FIG. 19 is a left side view of the one wedge shown in FIG. 7;

and,

FIG. 20 is a right side view of the one wedge shown in FIG. 7.

The broken lines shown in all of the figures are for environmental purposes and from no part of the claim.

1 Claim, 8 Drawing Sheets

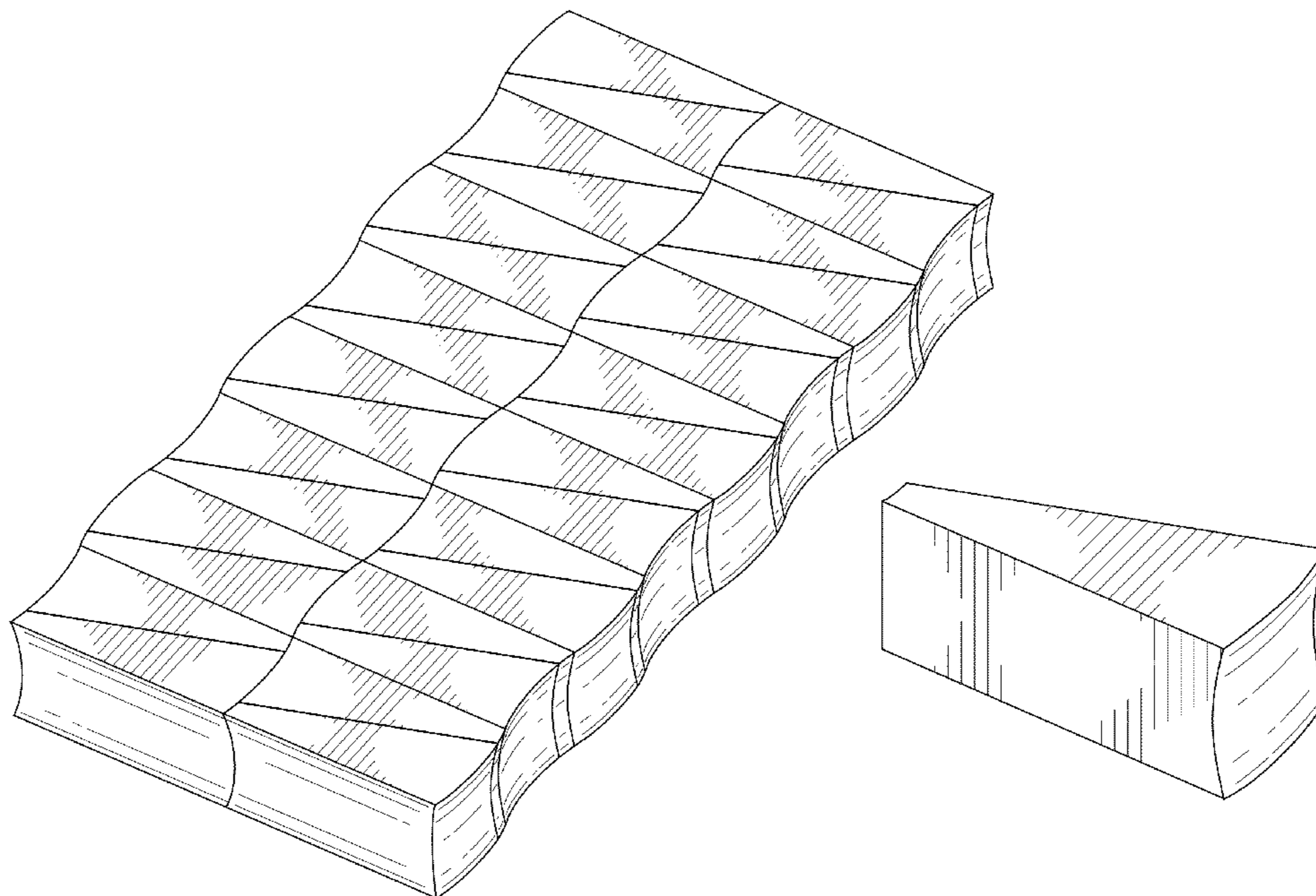

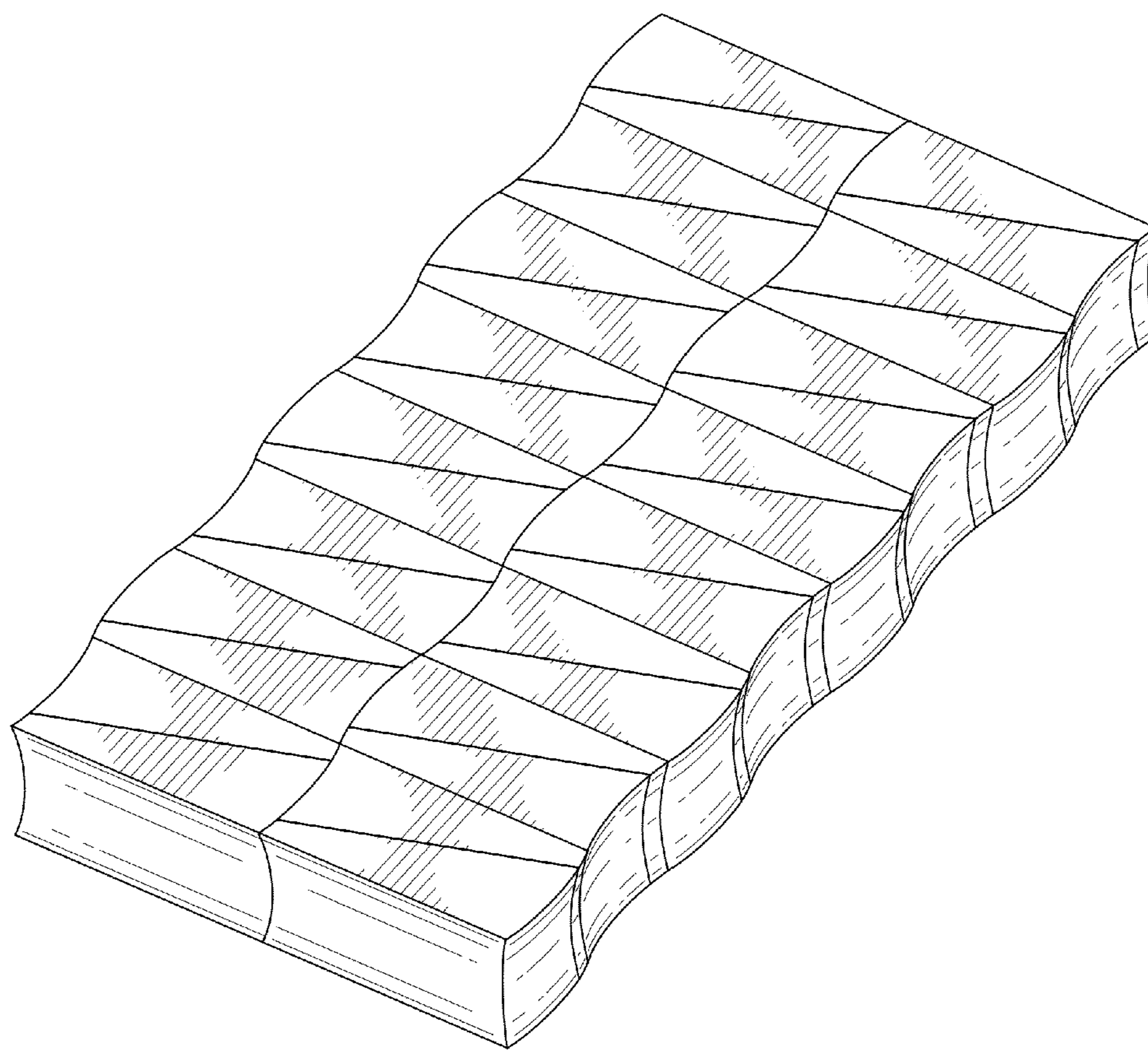

FIG. 1

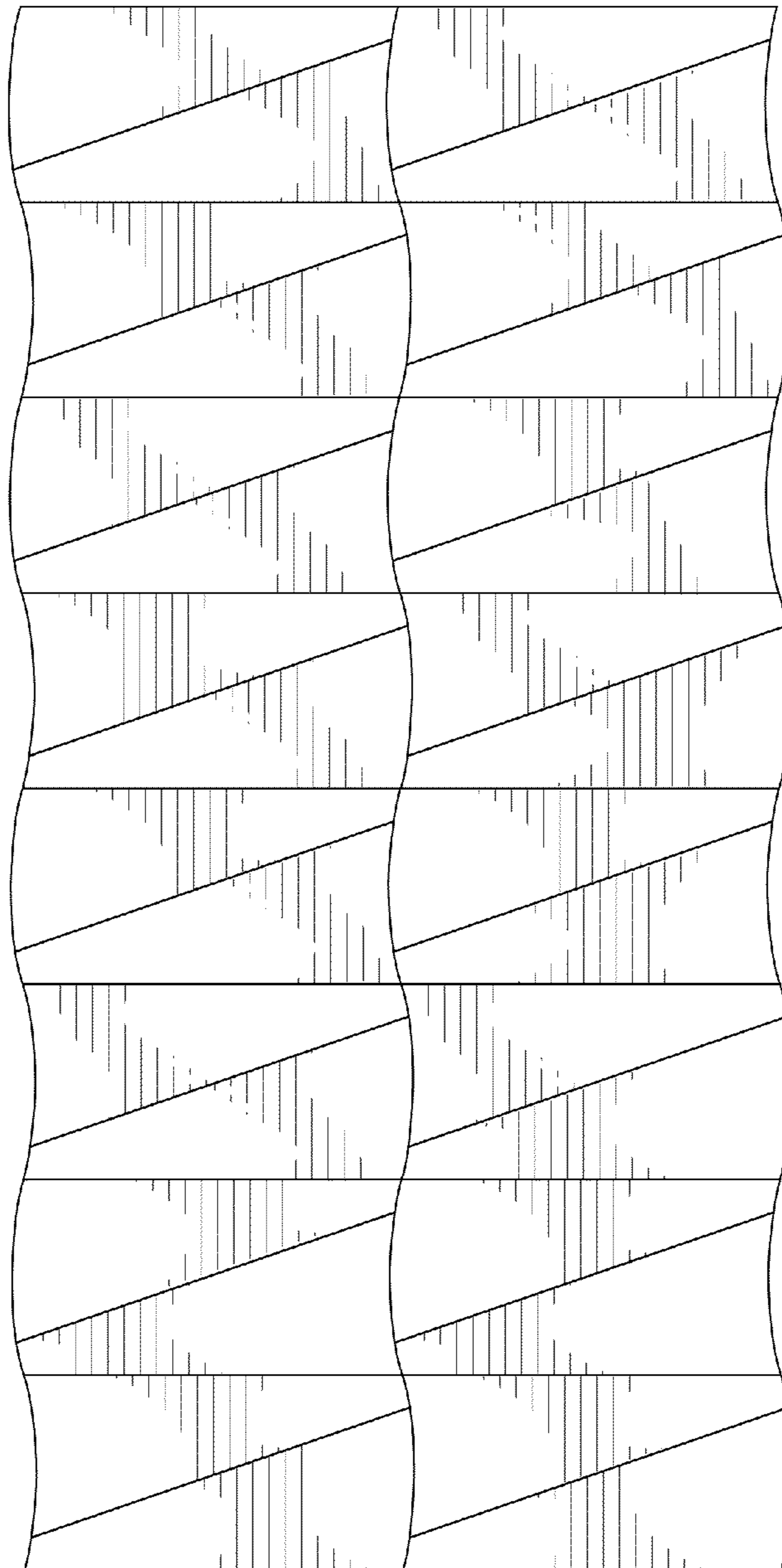

FIG. 2

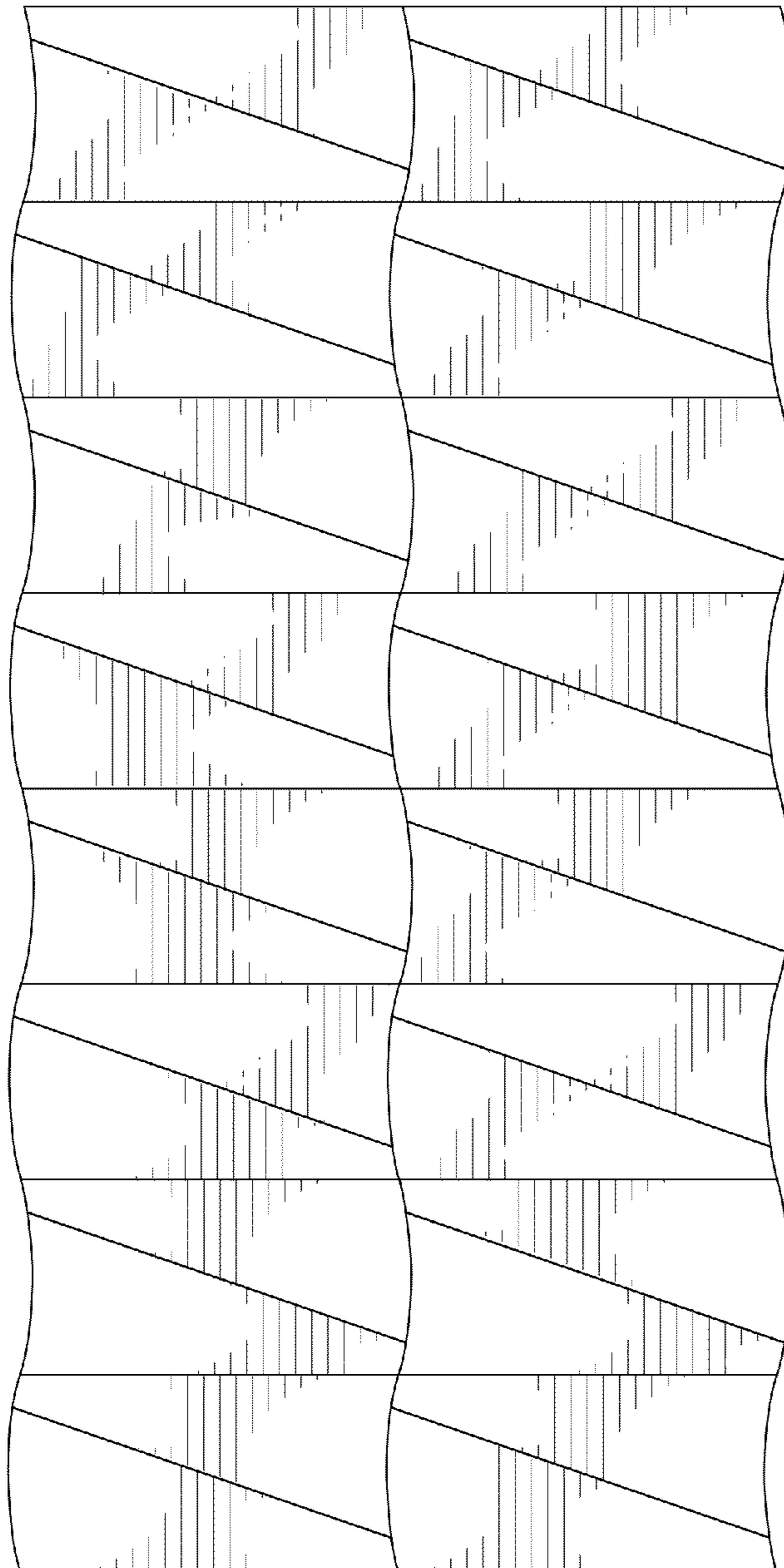

FIG. 3

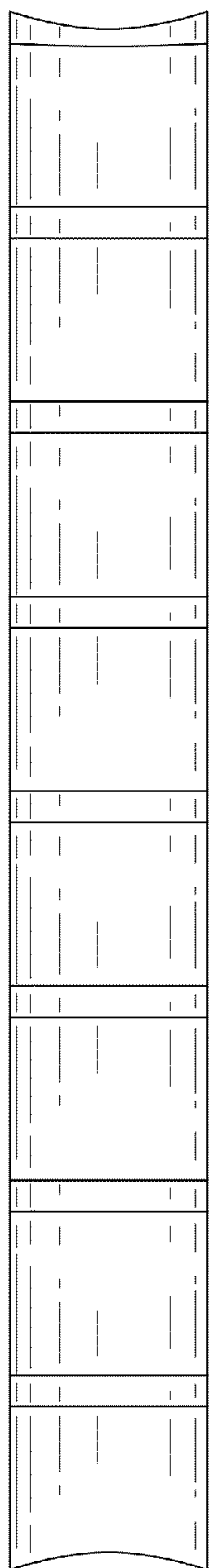

FIG. 4

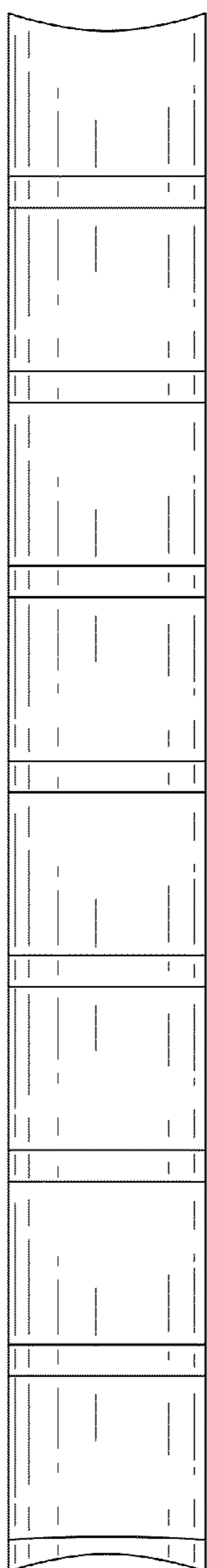

FIG. 5

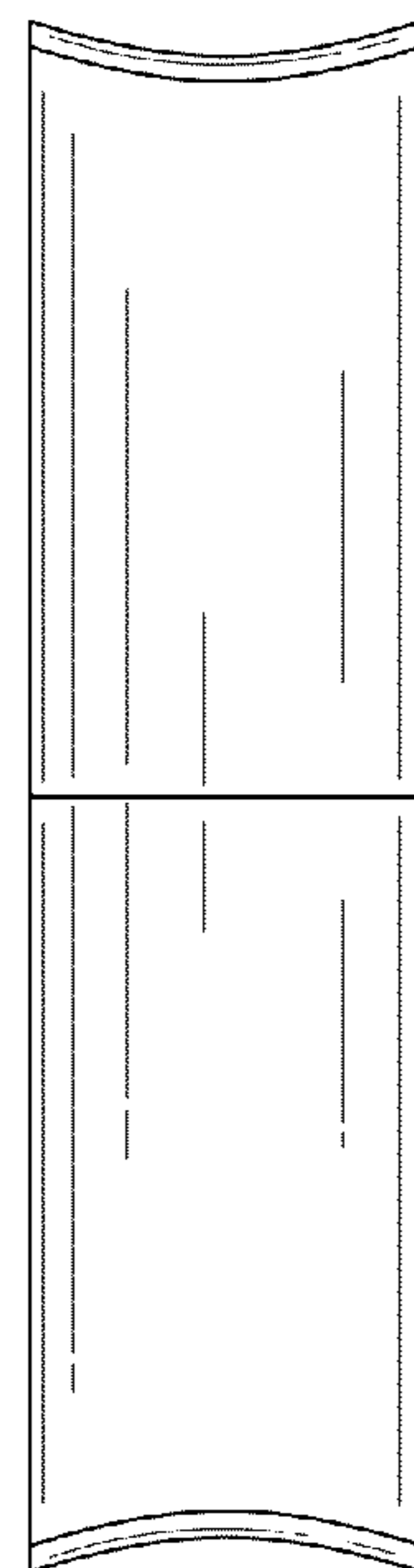

FIG. 6

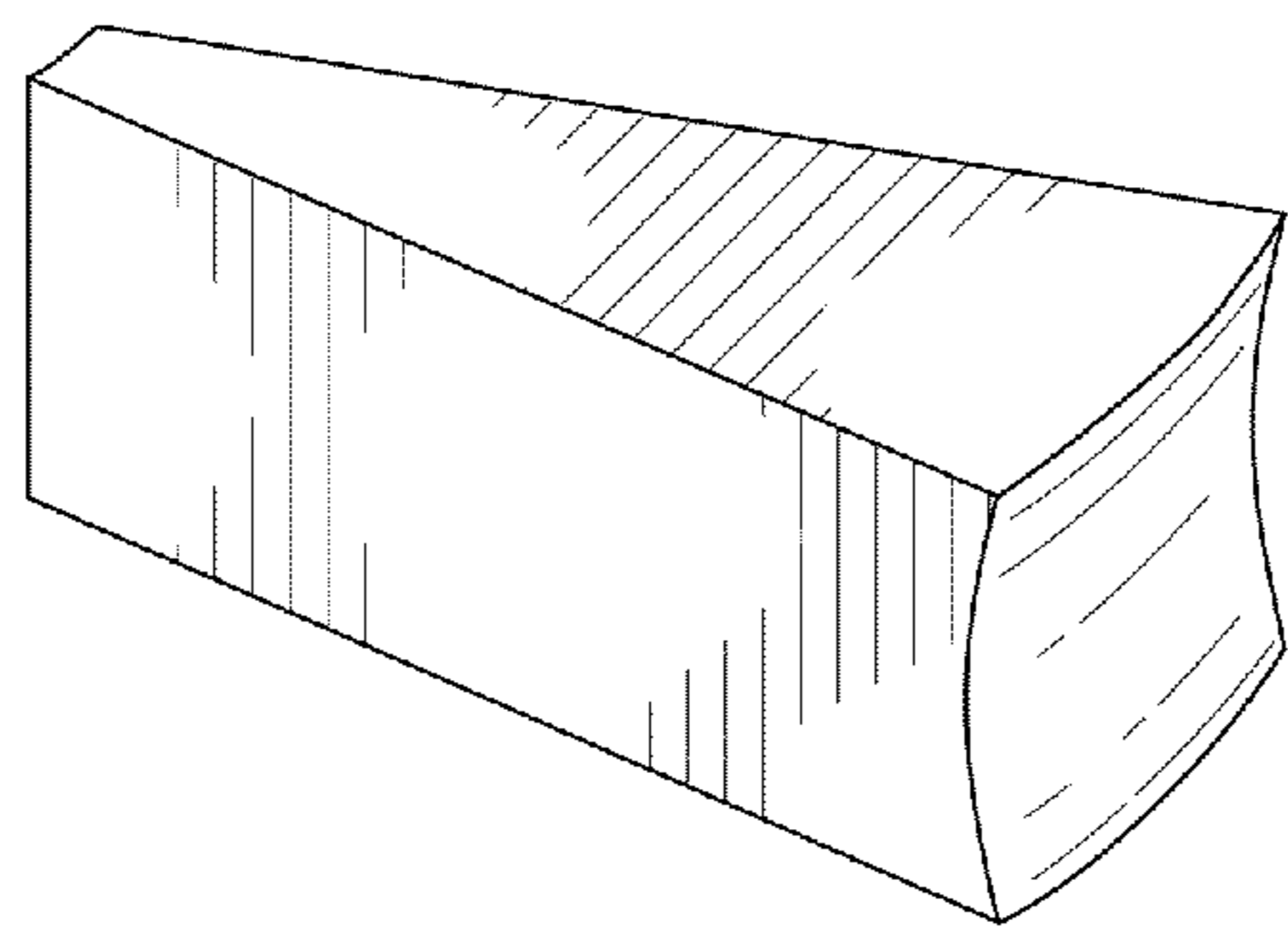

FIG. 7

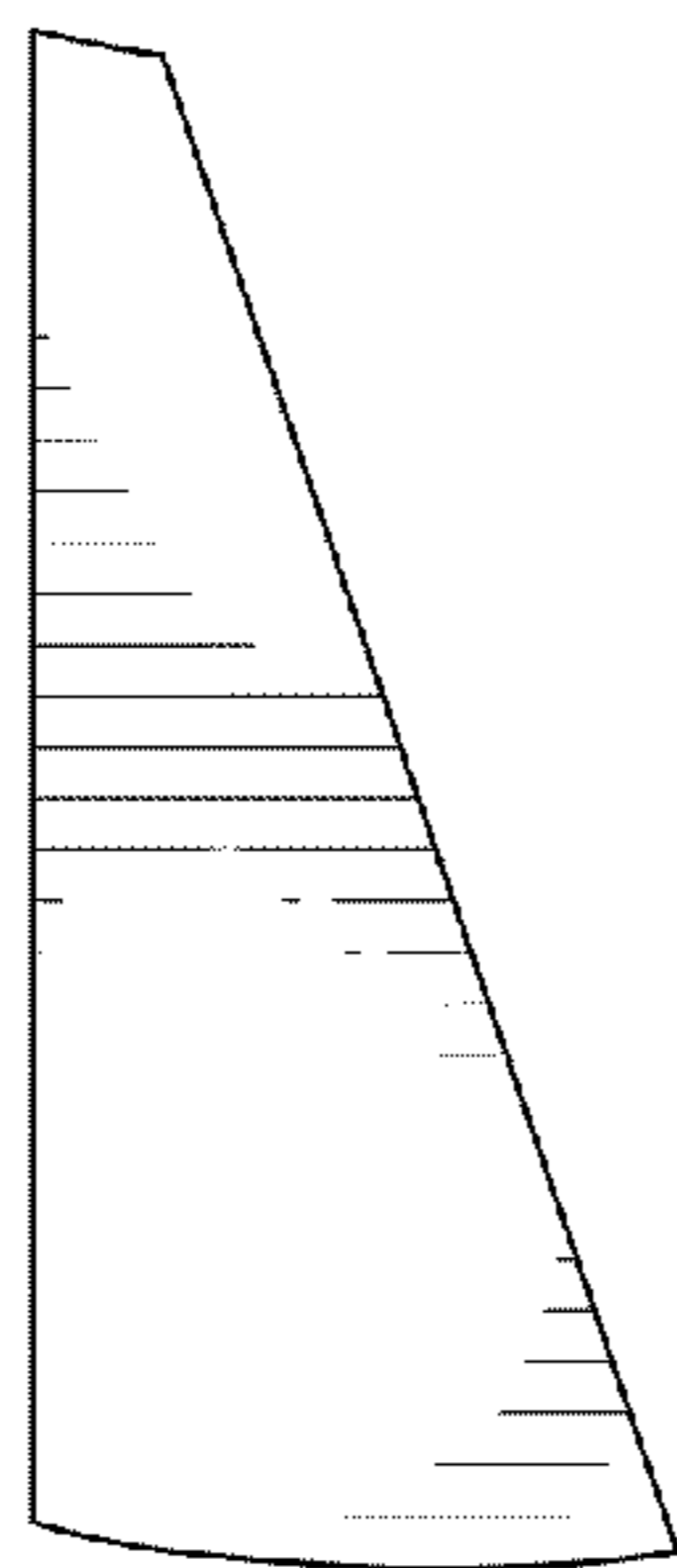

FIG. 8

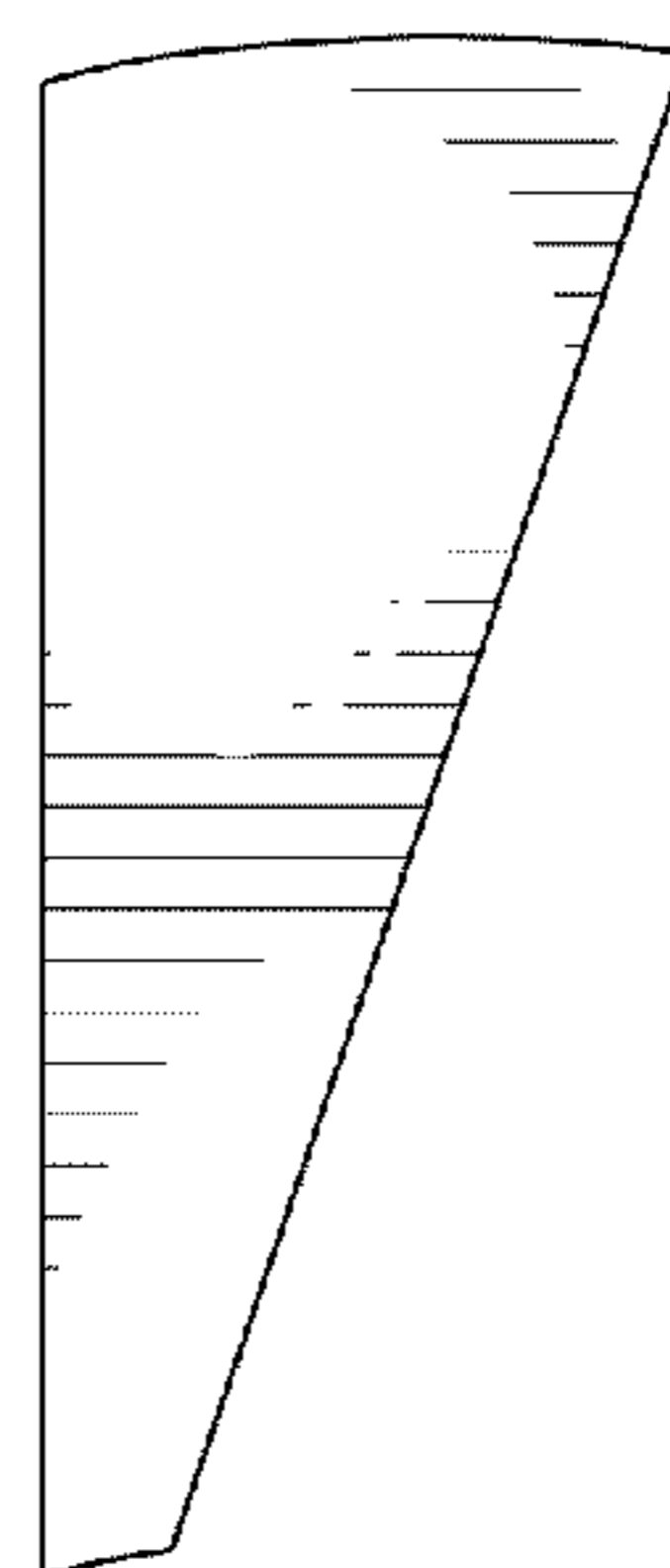

FIG. 9

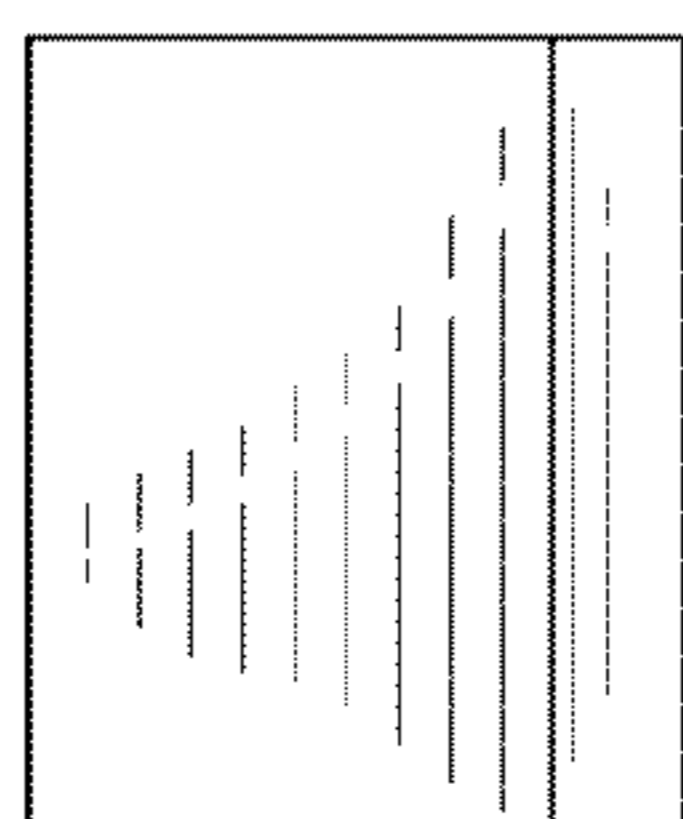

FIG. 10

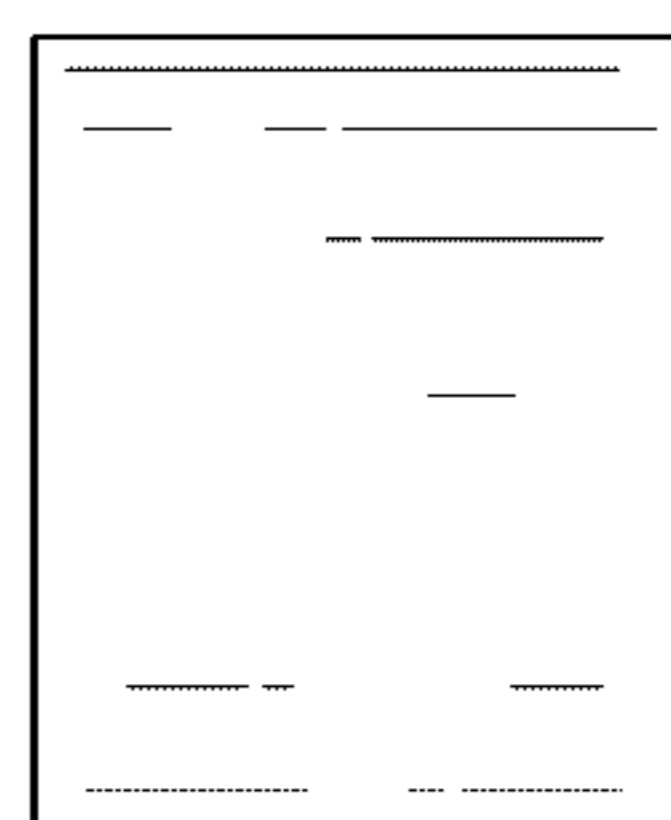

FIG. 11

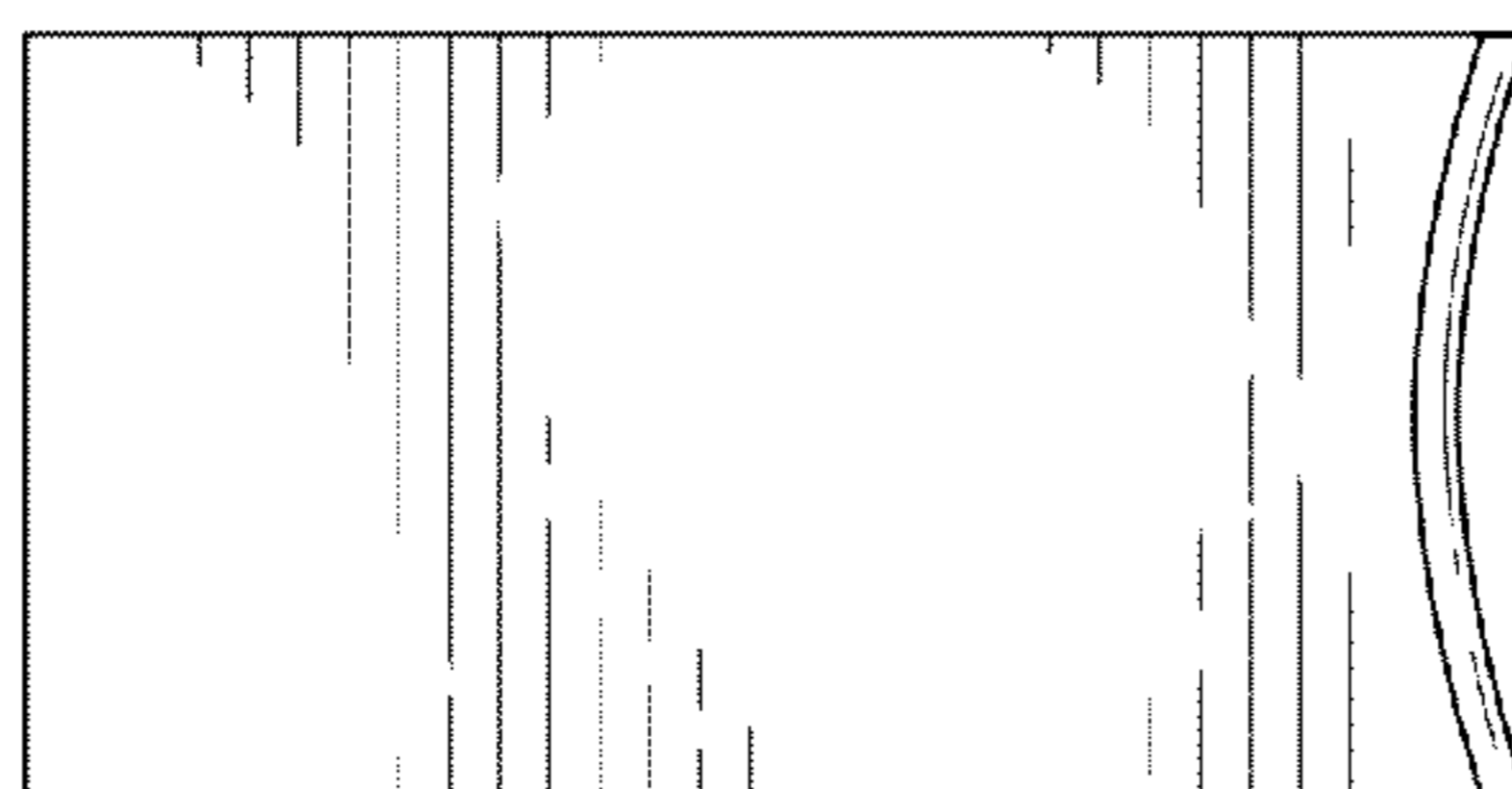

FIG. 12

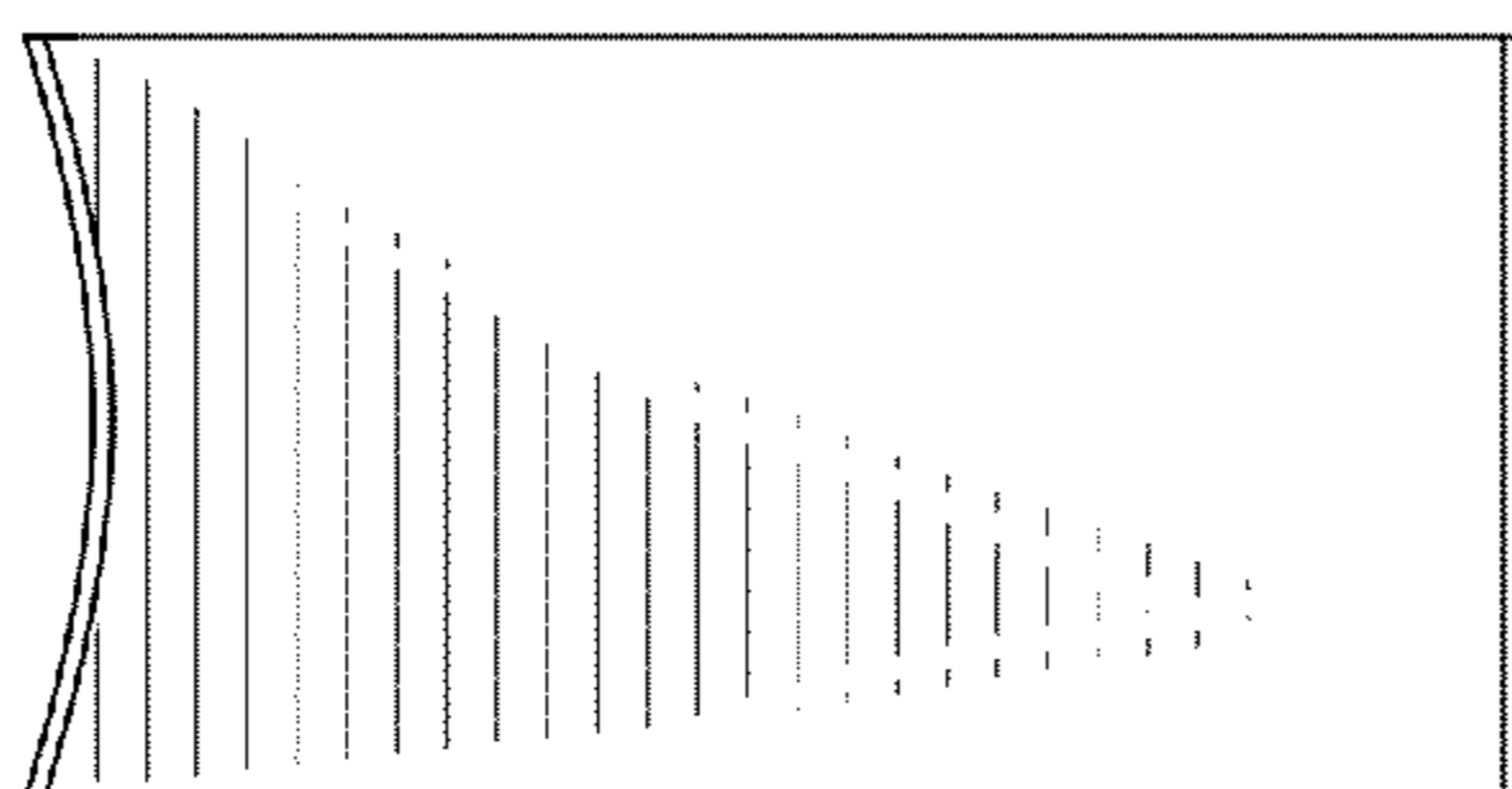

FIG. 13

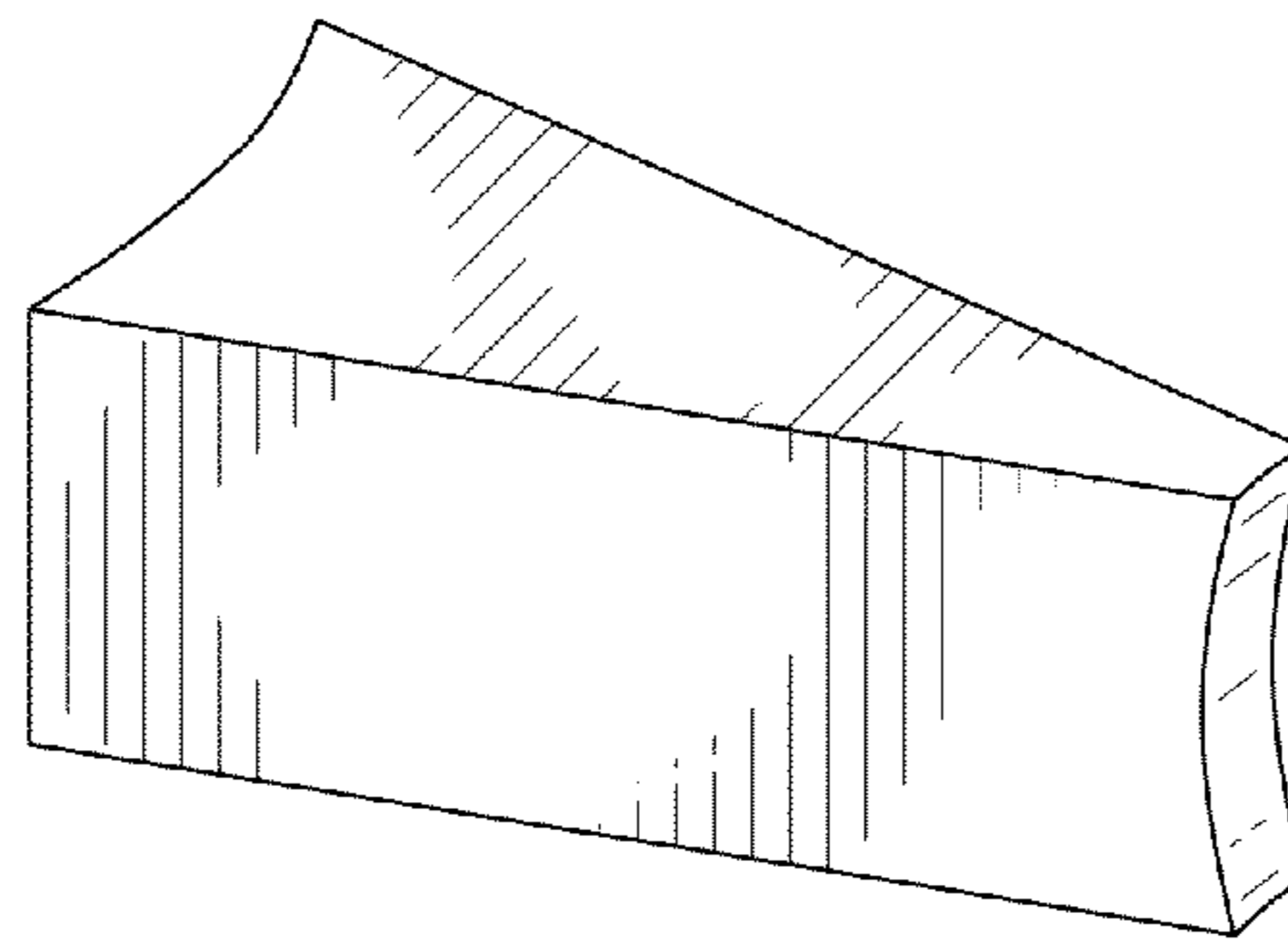

FIG. 14

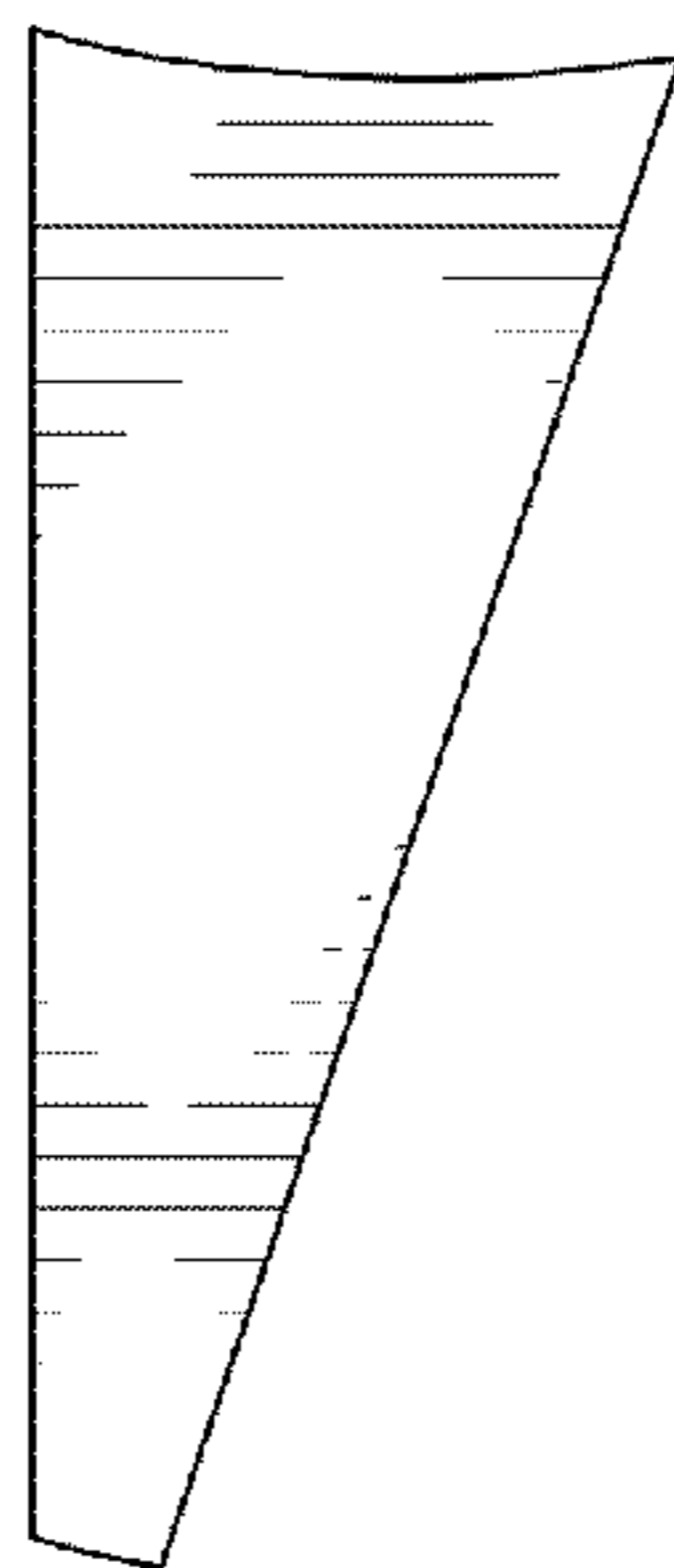

FIG. 15

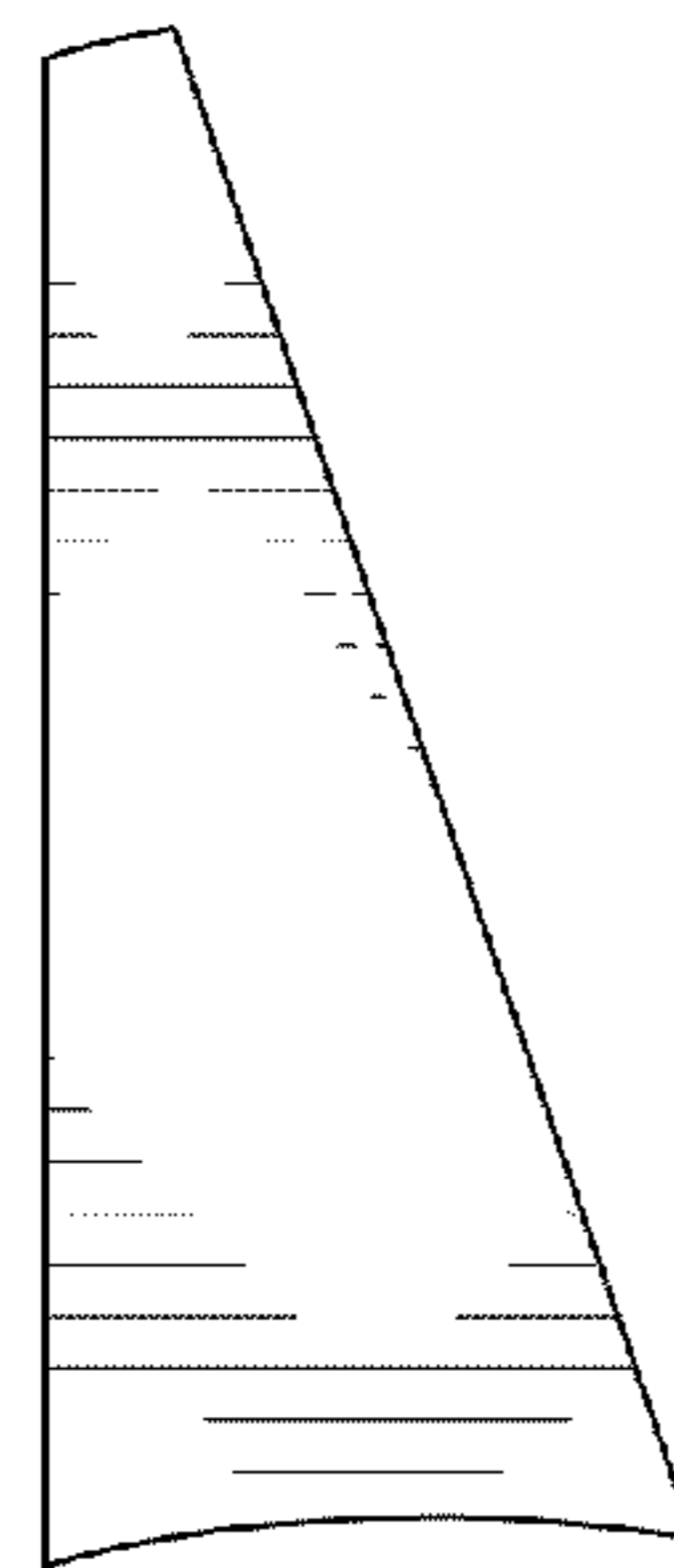

FIG. 16

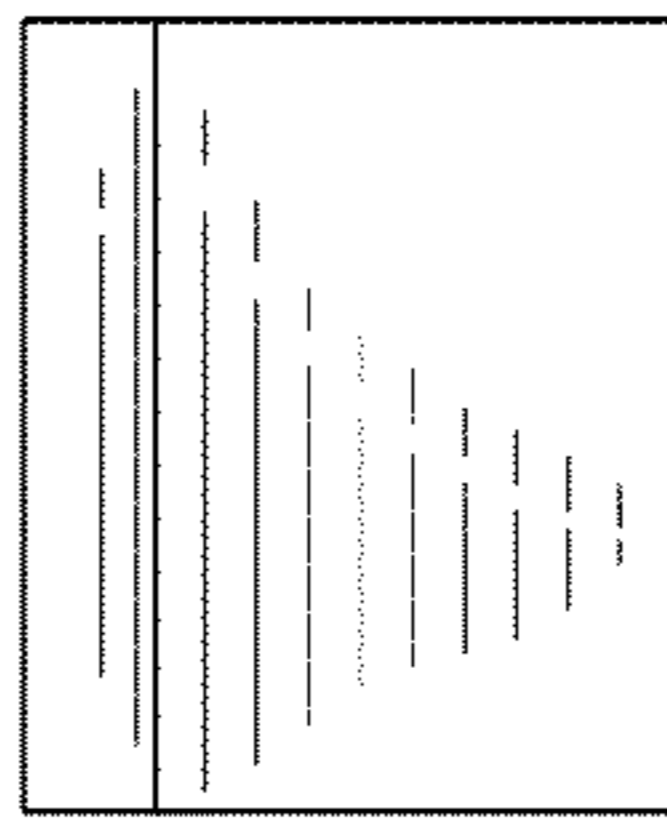

FIG. 17

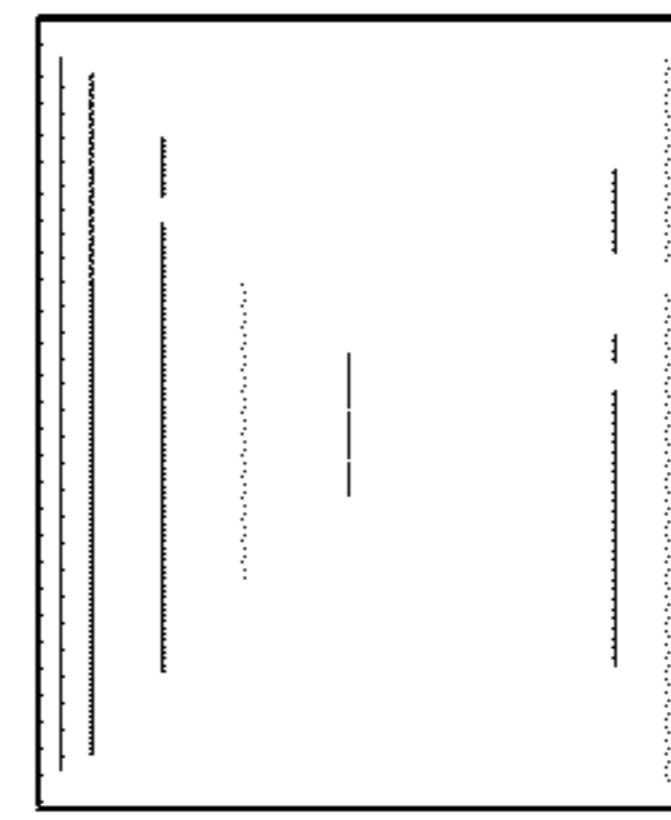

FIG. 18

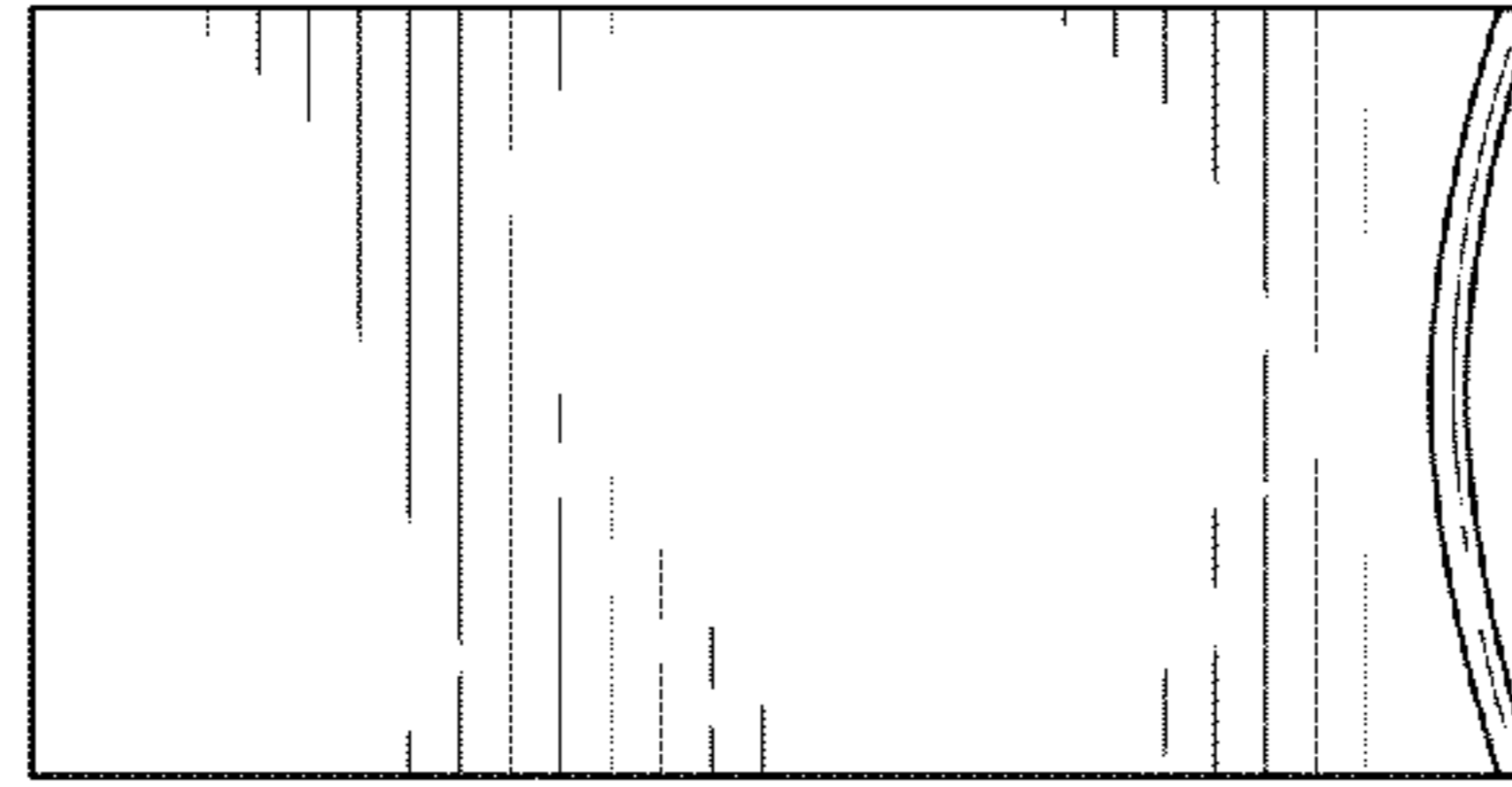

FIG. 19

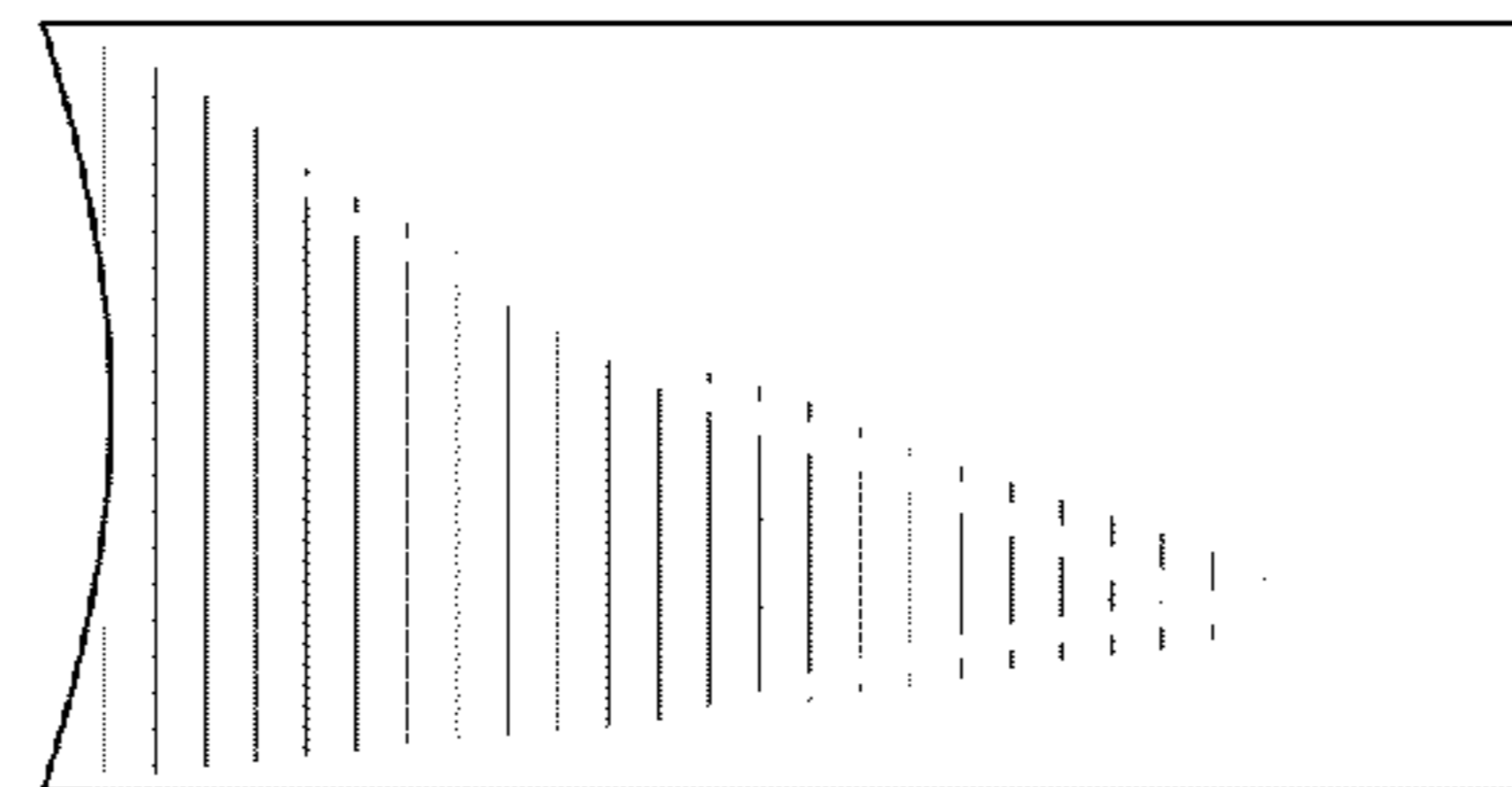

FIG. 20