

US00D669085S

(12) **United States Design Patent**  
**Coberly**

(10) **Patent No.:** **US D669,085 S**

(45) **Date of Patent:** **\*\* Oct. 16, 2012**

(54) **COMBINATION COVER AND STAND**

(76) Inventor: **Isaiah Coberly**, Lakewood, WA (US)

(\*\*) Term: **14 Years**

(21) Appl. No.: **29/410,483**

(22) Filed: **Jan. 9, 2012**

(51) **LOC (9) Cl.** ..... **08-07**

(52) **U.S. Cl.** ..... **D14/447**

(58) **Field of Classification Search** ..... D14/447,  
D14/432, 433, 434, 439, 448, 451, 452, 217,  
D14/239, 250, 251, 253, 238.1; D13/107,  
D13/108; D21/333; D6/300, 310, 311, 312,  
D6/406.1, 406.2, 406.3, 406.4, 406.5, 406.6,  
D6/419; D8/363, 373, 380

See application file for complete search history.

(56) **References Cited**

**U.S. PATENT DOCUMENTS**

4,318,527	A *	3/1982	Smith	.....	248/459
4,674,724	A *	6/1987	Gaudet	.....	248/459
5,029,798	A *	7/1991	Clark	.....	248/459
5,829,729	A *	11/1998	Welch et al.	.....	248/441.1
D534,360	S *	1/2007	Dempsey	.....	D6/312
7,185,869	B2 *	3/2007	Smith	.....	248/456
7,654,499	B2 *	2/2010	Lane	.....	248/459
7,739,816	B2 *	6/2010	Kowatari	.....	40/124.09
D639,814	S *	6/2011	Farris-Gilbert et al.	.....	D14/447
D643,635	S *	8/2011	Harding	.....	D6/310
D648,728	S *	11/2011	Atkins et al.	.....	D14/447
2008/0054149	A1 *	3/2008	Freebairn	.....	248/346.02
2011/0278421	A1 *	11/2011	Guldalian	.....	248/459

\* cited by examiner

*Primary Examiner* — Angela J Lee

(74) *Attorney, Agent, or Firm* — Maschoff Gilmore & Israelsen

(57) **CLAIM**

The ornamental design for a combination cover and stand, as shown and described.

**DESCRIPTION**

FIG. 1 is a front perspective view of a combination cover and stand showing my new design;

FIG. 2 is a top view of the combination cover and stand shown in FIG. 1;

FIG. 3 is a first side view of the combination cover and stand shown in FIG. 1;

FIG. 4 is a front view of the combination cover and stand shown in FIG. 1;

FIG. 5 is a second side view of the combination cover and stand shown in FIG. 1;

FIG. 6 is a bottom view of the combination cover and stand shown in FIG. 1;

FIG. 7 is a back view of the combination cover and stand shown in FIG. 1;

FIG. 8 is a side perspective view of the combination cover and stand thereof, but shown in a folded position; and,

FIG. 9 is a back perspective view thereof.

In FIGS. 1, 4, and 7-9, the uneven broken lines indicate fold lines in the combination cover and stand and form part of the claimed design and the double solid lines indicate openings in the combination cover and stand and form part of the claimed design. In FIGS. 1-9, the even broken lines indicate environmental structure only that forms no part of the claimed design.

**1 Claim, 5 Drawing Sheets**

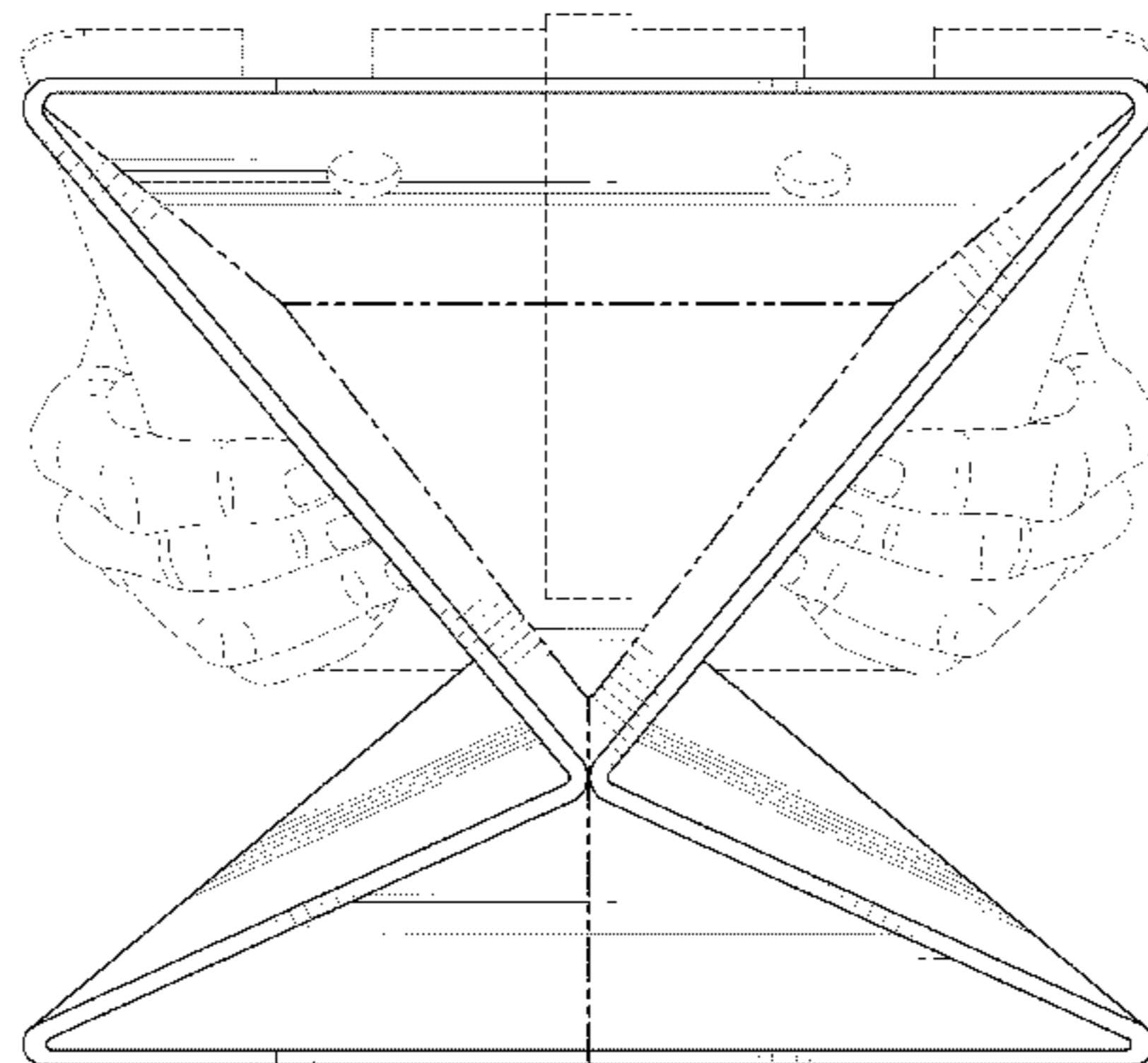
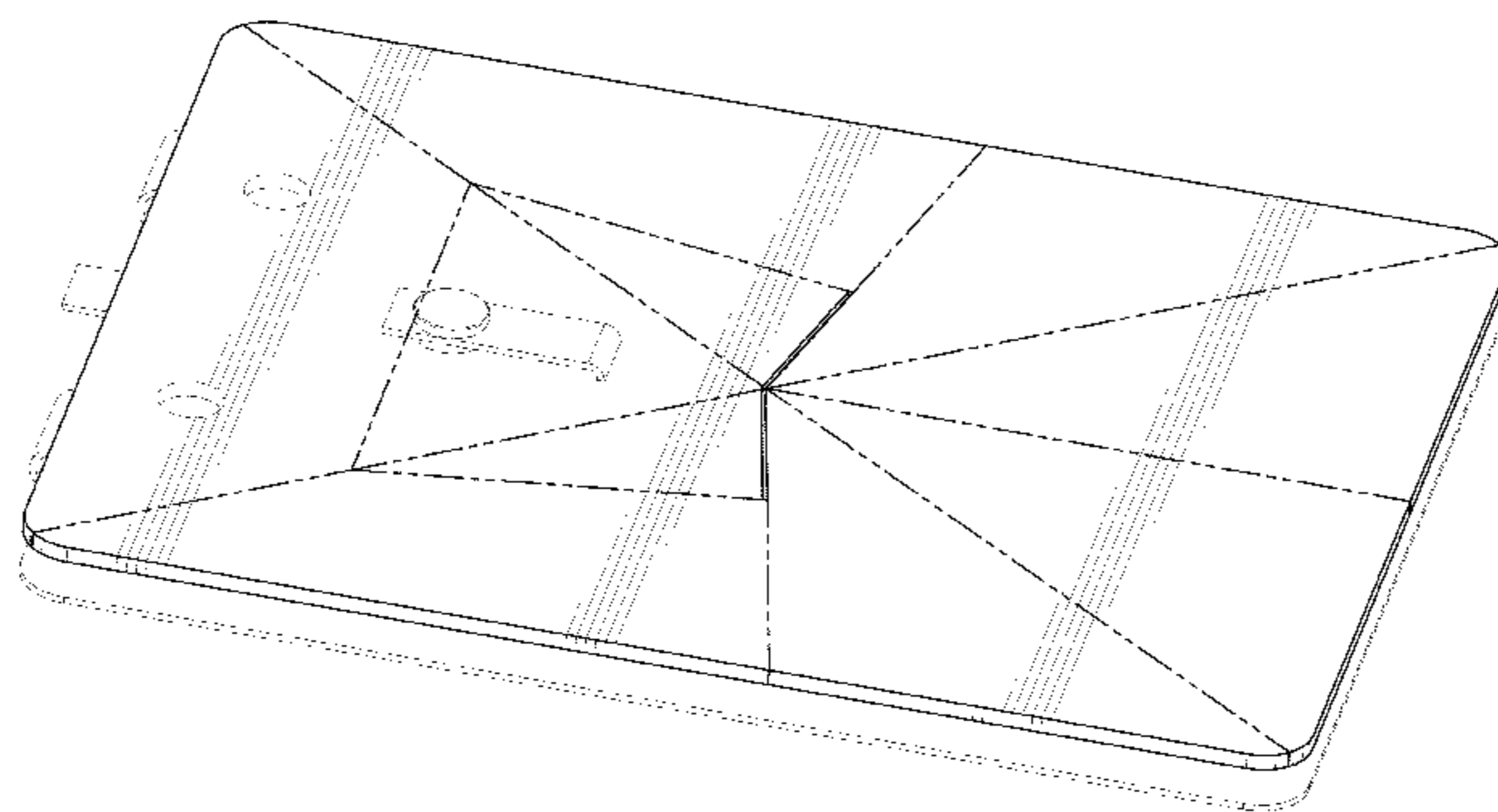

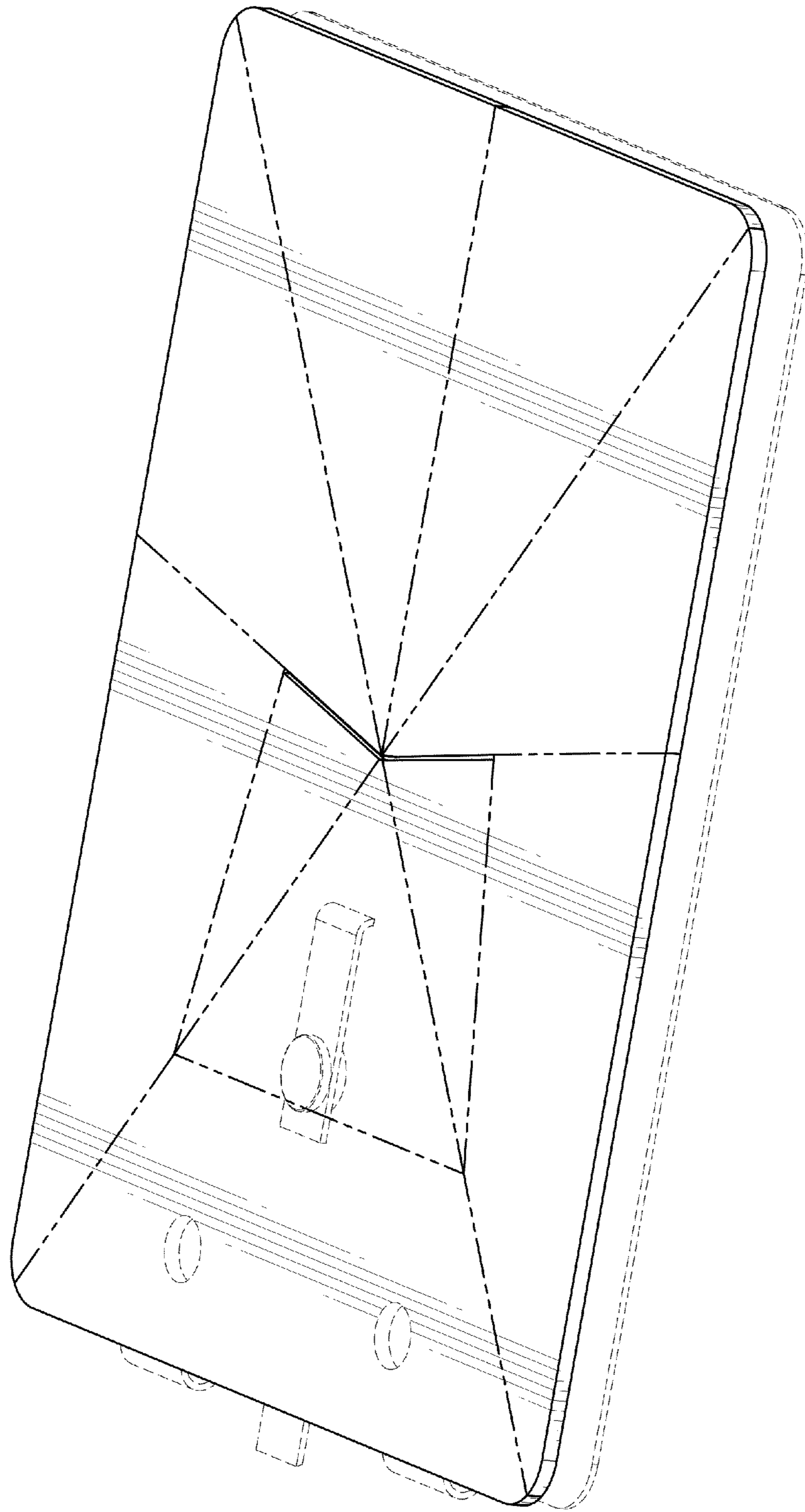
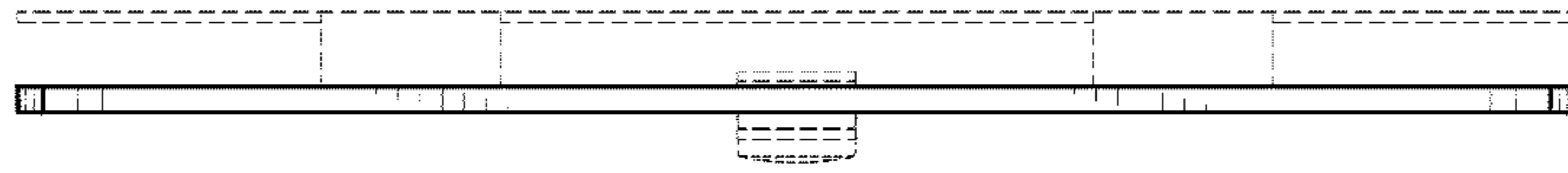
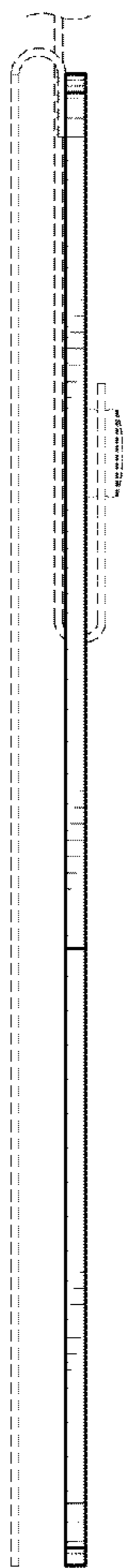

Fig. 1



**Fig. 2**



**Fig. 3**

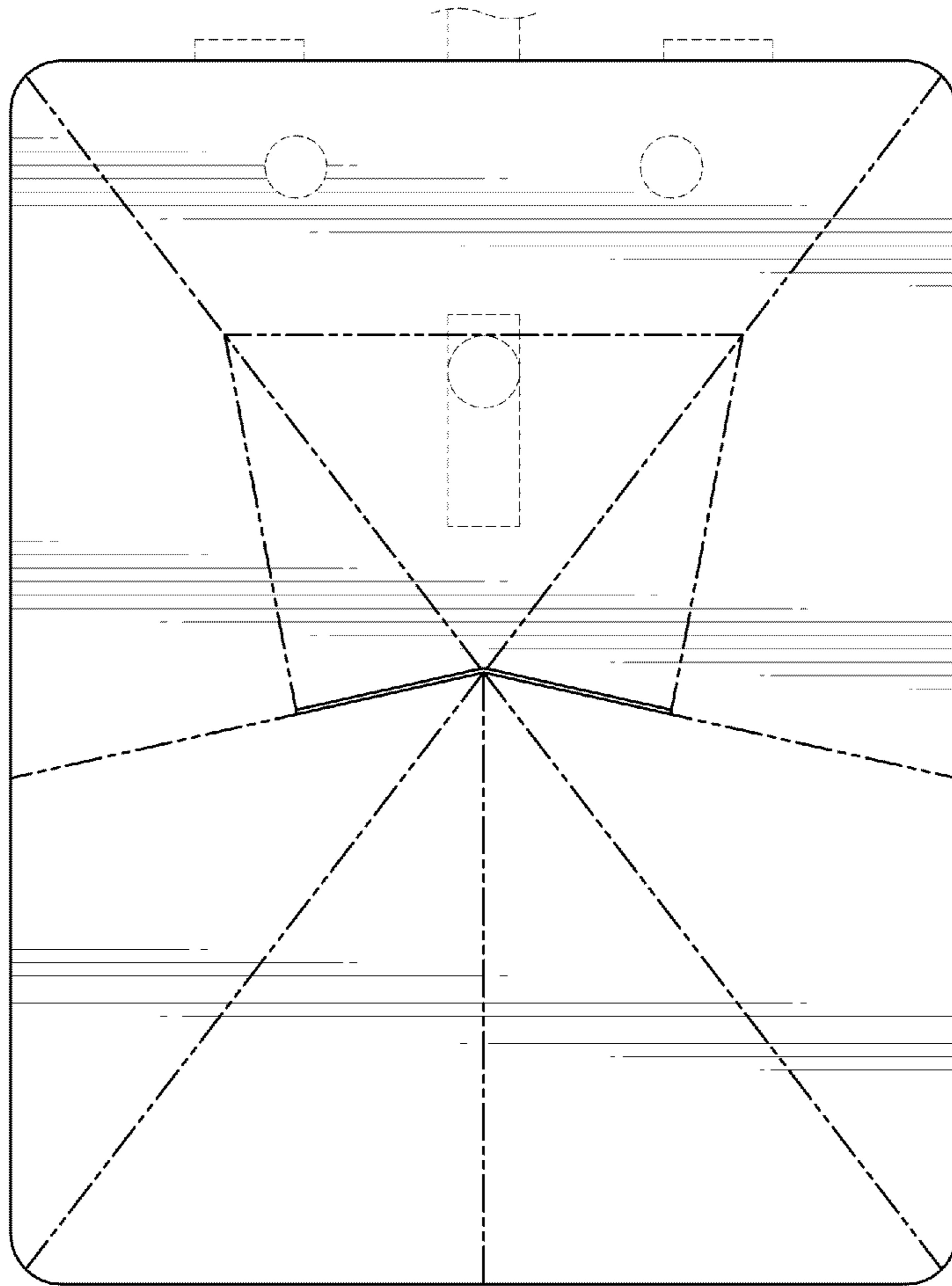

**Fig. 4**

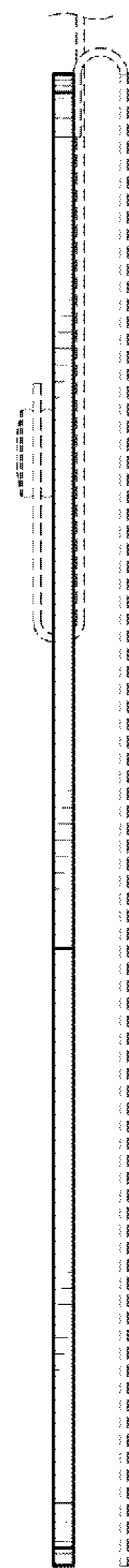

**Fig. 5**

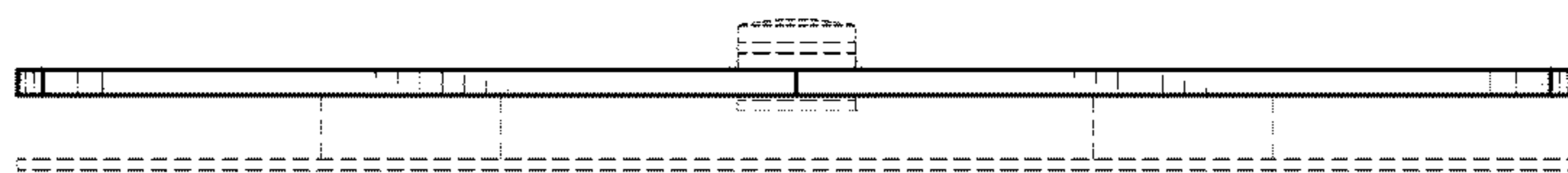

**Fig. 6**

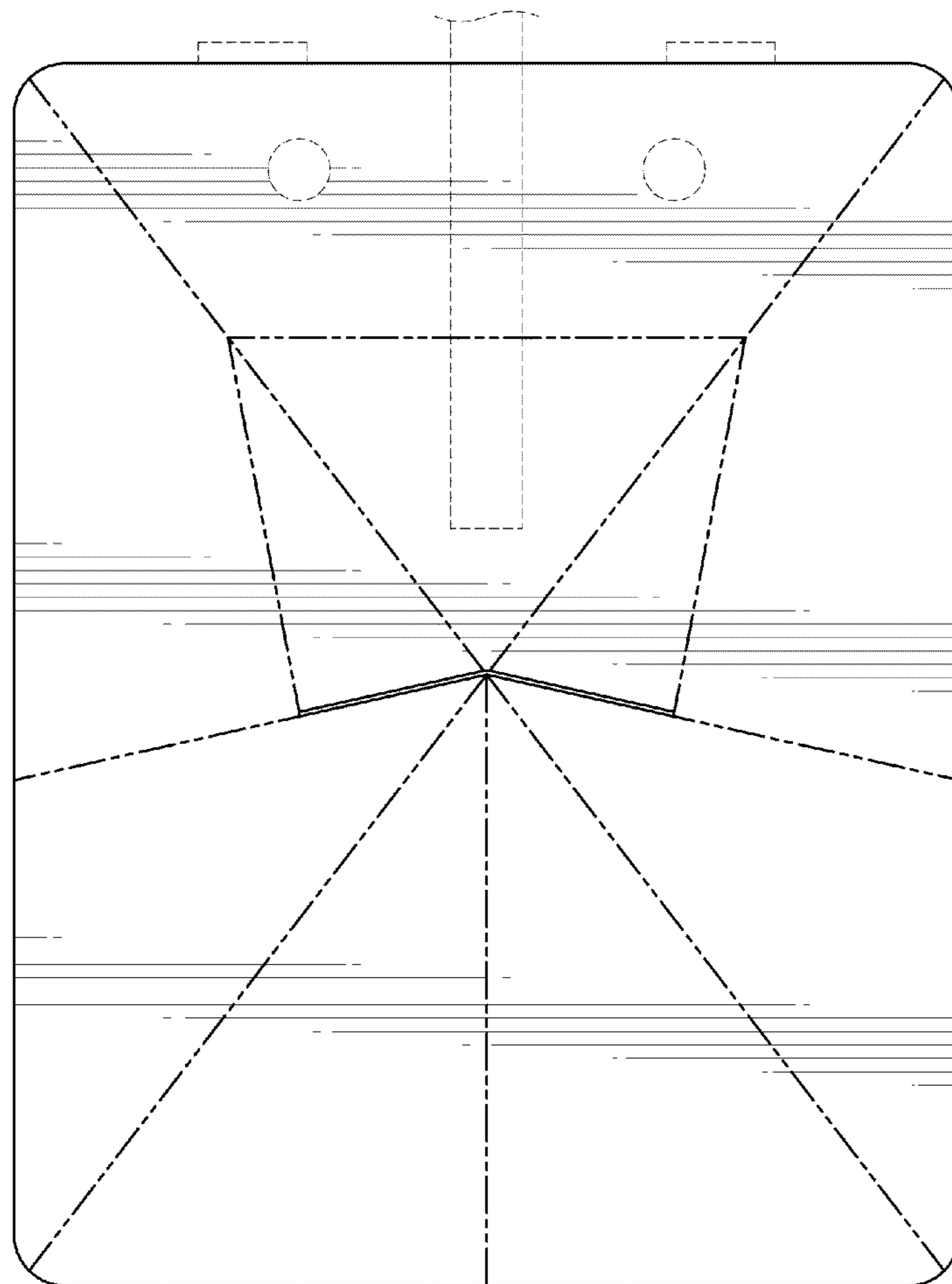

*Fig. 7*

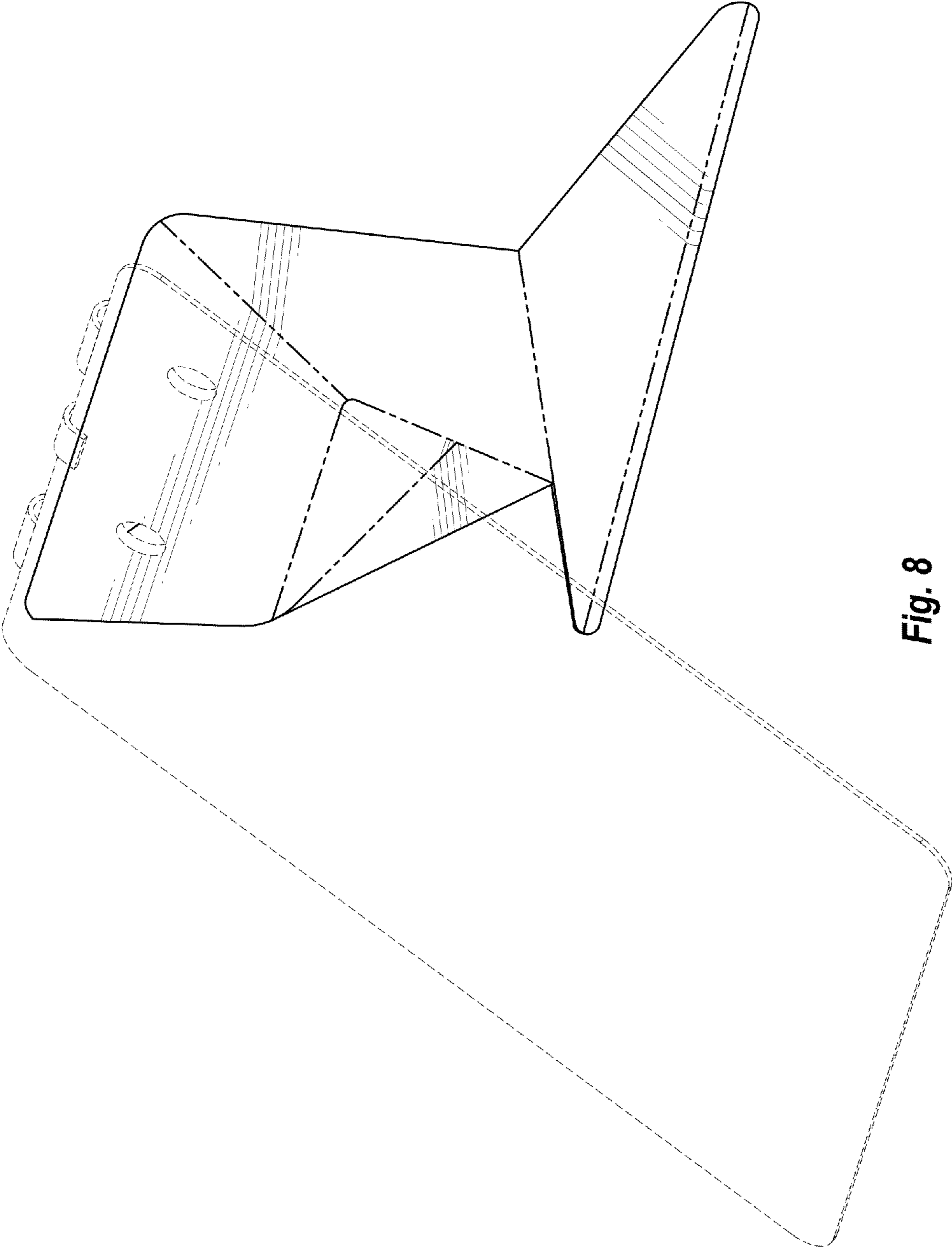

Fig. 8

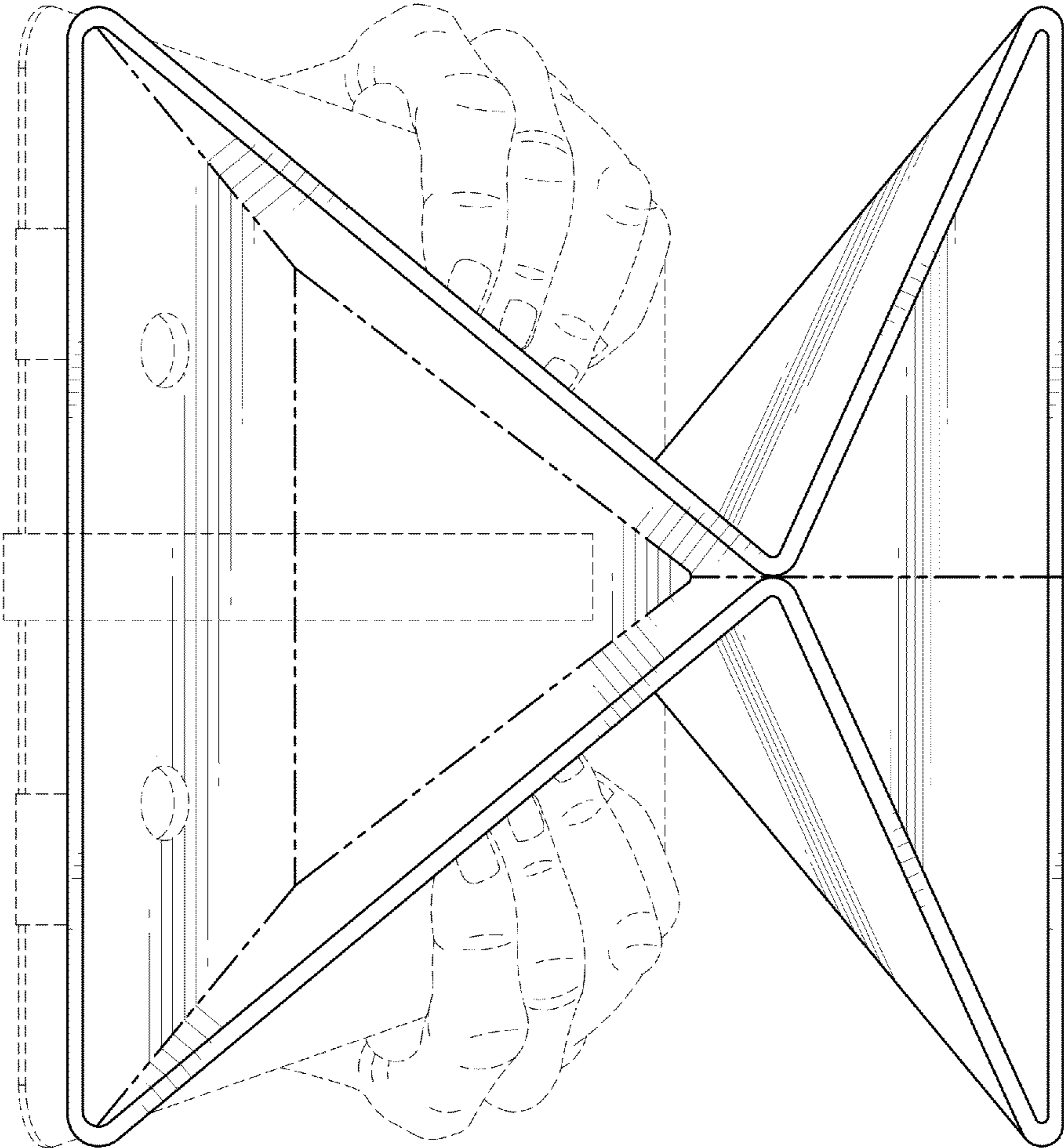

Fig. 9