

US00D669084S

(12) **United States Design Patent**  
**Yokoyama**

(10) **Patent No.:** **US D669,084 S**  
(45) **Date of Patent:** **\*\* Oct. 16, 2012**

(54) **PART OF LEVER FOR CARD CONNECTOR**

(75) Inventor: **Yohei Yokoyama**, Tokyo (JP)

(73) Assignee: **Japan Aviation Electronics Industry, Limited**, Tokyo (JP)

(\*\*) Term: **14 Years**

(21) Appl. No.: **29/415,858**

(22) Filed: **Mar. 15, 2012**

(30) **Foreign Application Priority Data**

Sep. 26, 2011 (JP) ..... 2011-021866

(51) **LOC (9) Cl.** ..... **14-02**

(52) **U.S. Cl.** ..... **D14/432**

(58) **Field of Classification Search** ..... D14/316-319,  
D14/432-439, 442, 451-454, 496, 495, 391,  
D14/385, 367, 356; D8/331, 330; D18/50,  
D18/4.6, 4.5; 439/630, 635, 639, 160; 360/2;  
235/492, 486, 479, 380

See application file for complete search history.

(56) **References Cited**

**U.S. PATENT DOCUMENTS**

D366,207 S *	1/1996	Thompson	.....	D8/373
D373,074 S *	8/1996	Miyashita	.....	D8/382
D410,192 S *	5/1999	Giese	.....	D8/354
D438,512 S *	3/2001	Nishio et al.	.....	D13/147
D438,778 S *	3/2001	Ribe	.....	D8/354
6,406,312 B1 *	6/2002	Heitkamp	.....	439/160

6,948,961 B2	9/2005	Oguchi	
D526,558 S *	8/2006	Banta	..... D8/354
D556,014 S *	11/2007	Wurdack	..... D8/349
7,295,447 B2 *	11/2007	Strmiska et al.	..... 361/798
D578,127 S *	10/2008	Crisp et al.	..... D14/432
D612,224 S *	3/2010	Wendt	..... D8/354
D619,878 S *	7/2010	Sjoqvist	..... D8/354
D655,149 S *	3/2012	Dotsey	..... D8/354

\* cited by examiner

*Primary Examiner* — Austin Murphy

(74) *Attorney, Agent, or Firm* — Cermak Nakajima LLP;  
Tomoko Nakajima

(57) **CLAIM**

The ornamental design for a part of lever for card connector, as shown and described.

**DESCRIPTION**

FIG. 1 is a front elevational view of a part of lever for card connector showing my new design;  
FIG. 2 is a top plan view thereof;  
FIG. 3 is a right side elevational view thereof;  
FIG. 4 is a left side elevational view thereof;  
FIG. 5 is a rear elevational view thereof;  
FIG. 6 is a bottom plan view thereof.  
FIG. 7 is a front and top perspective view thereof;  
FIG. 8 is a front and bottom perspective view thereof;  
FIG. 9 is a rear and top perspective view thereof; and,  
FIG. 10 is a rear and bottom perspective view thereof.  
The broken lines shown in FIGS. 1-10 are for illustrative purposes only and form no part of the claimed design.

**1 Claim, 10 Drawing Sheets**

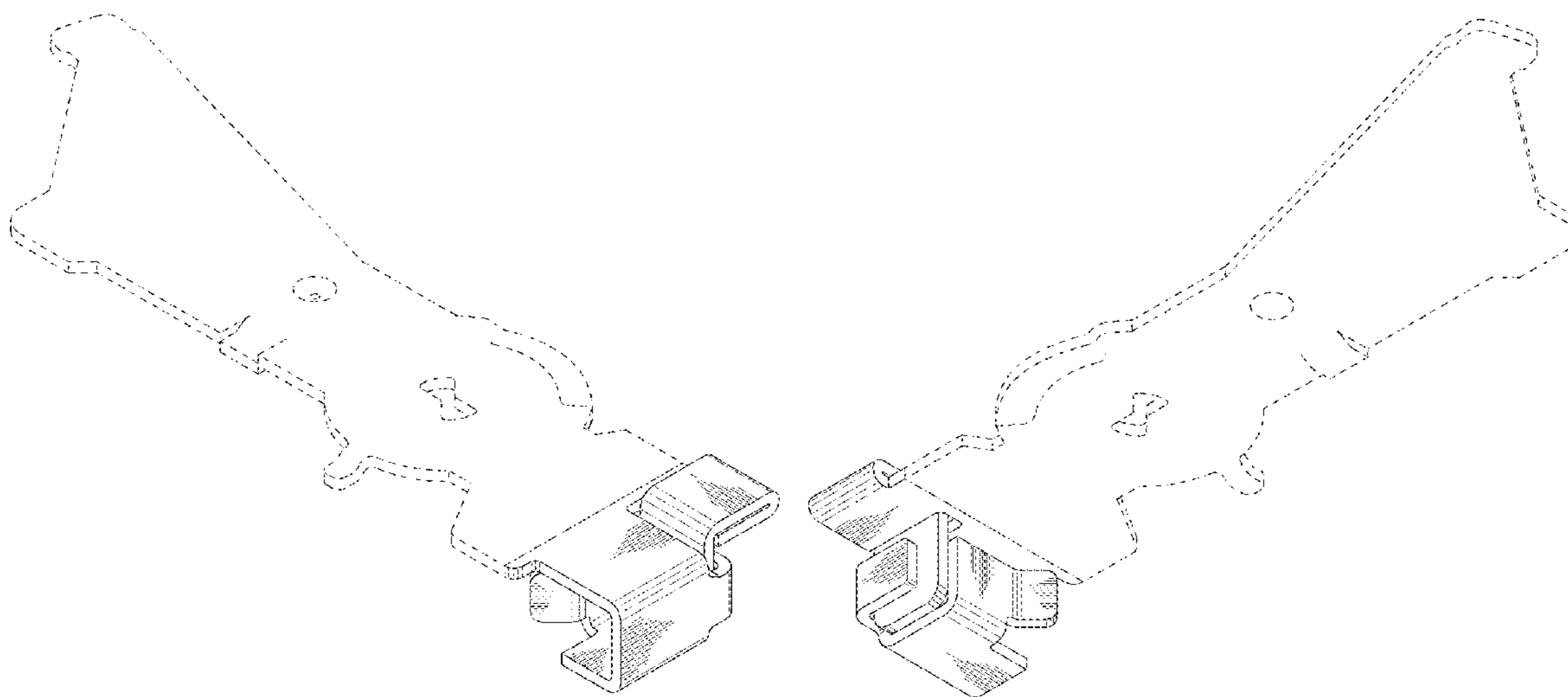



FIG. 1

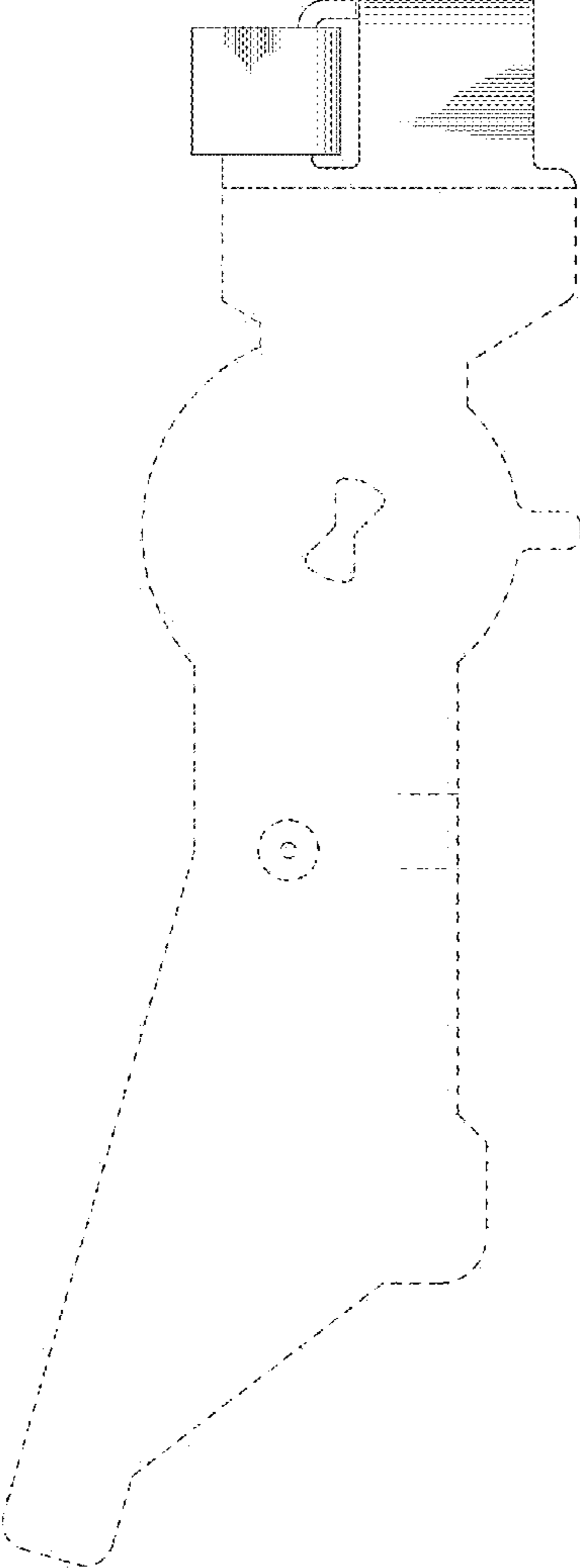

FIG.2

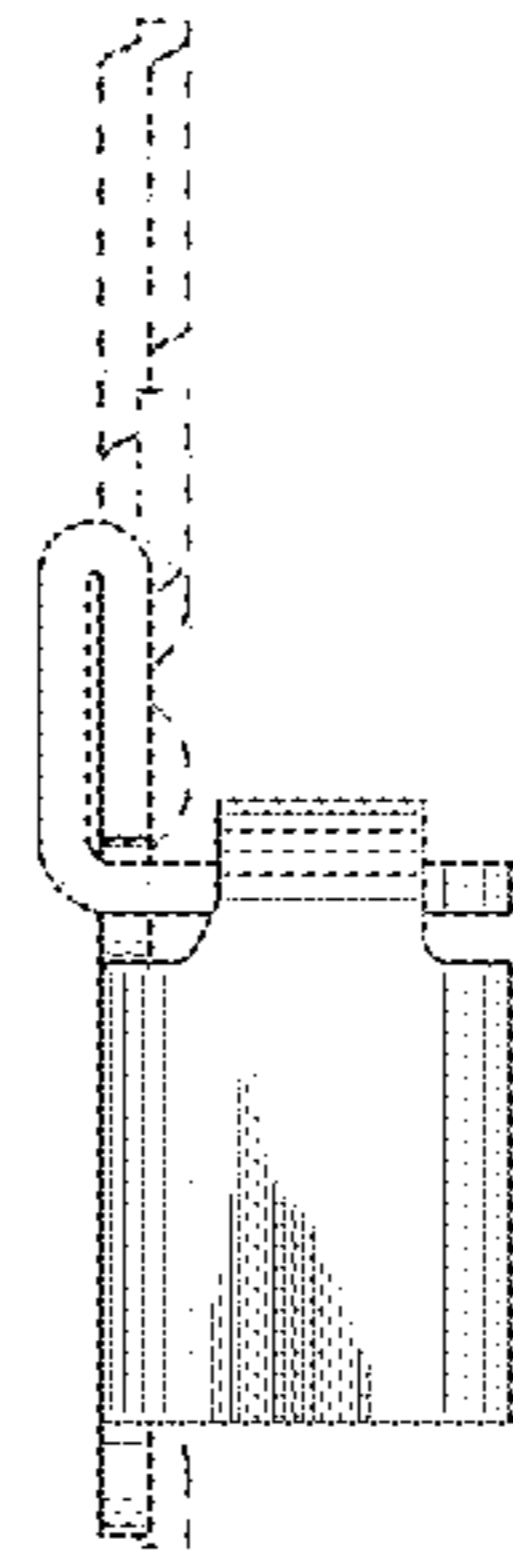

FIG.3

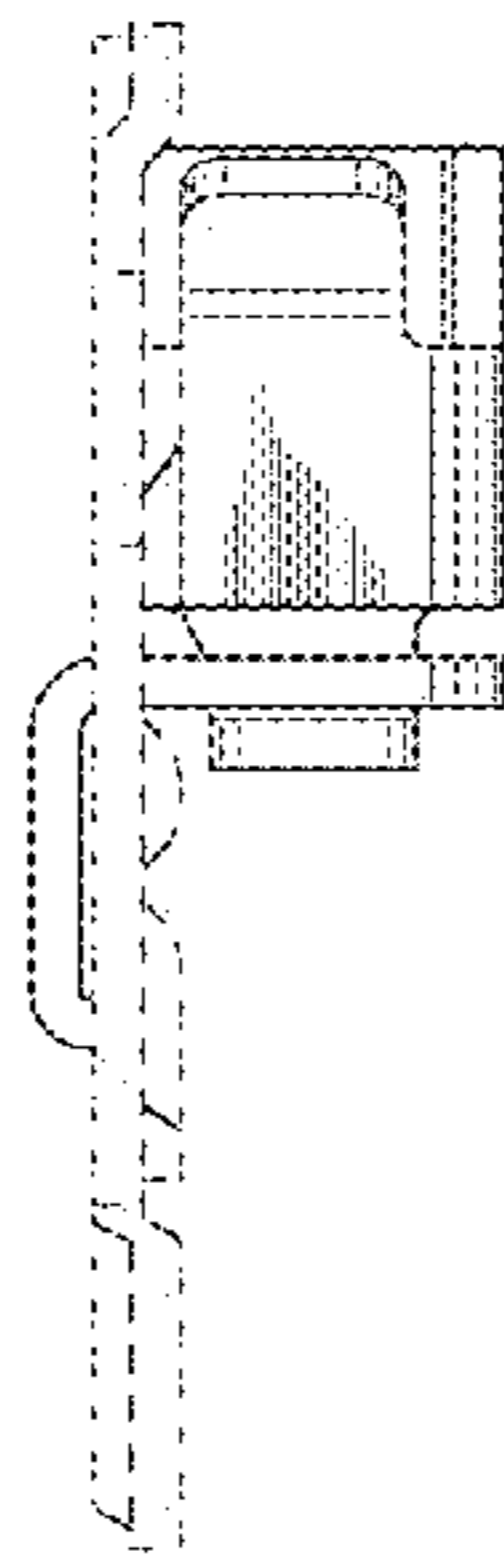

FIG.4

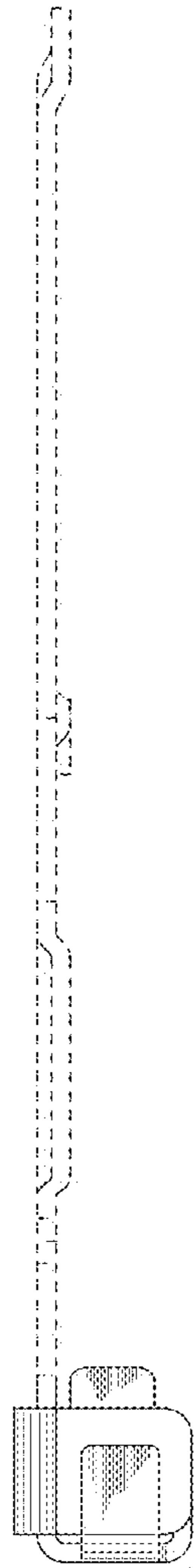

FIG. 5

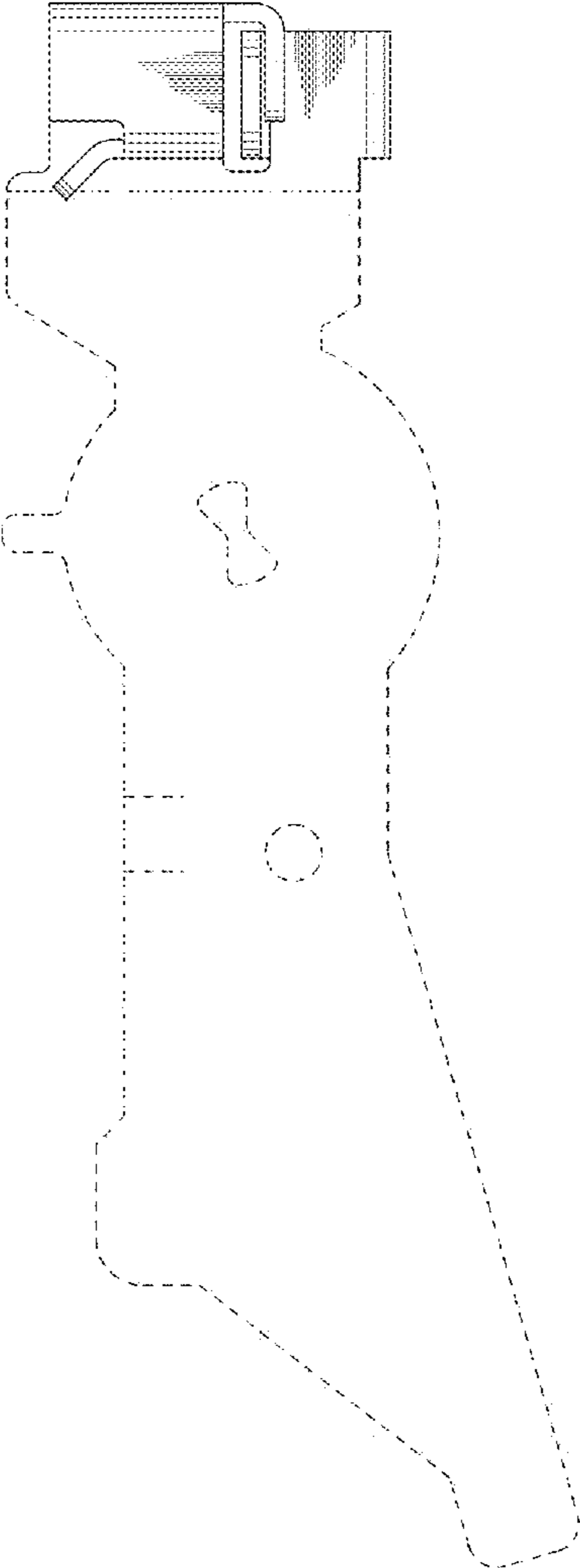

FIG.6

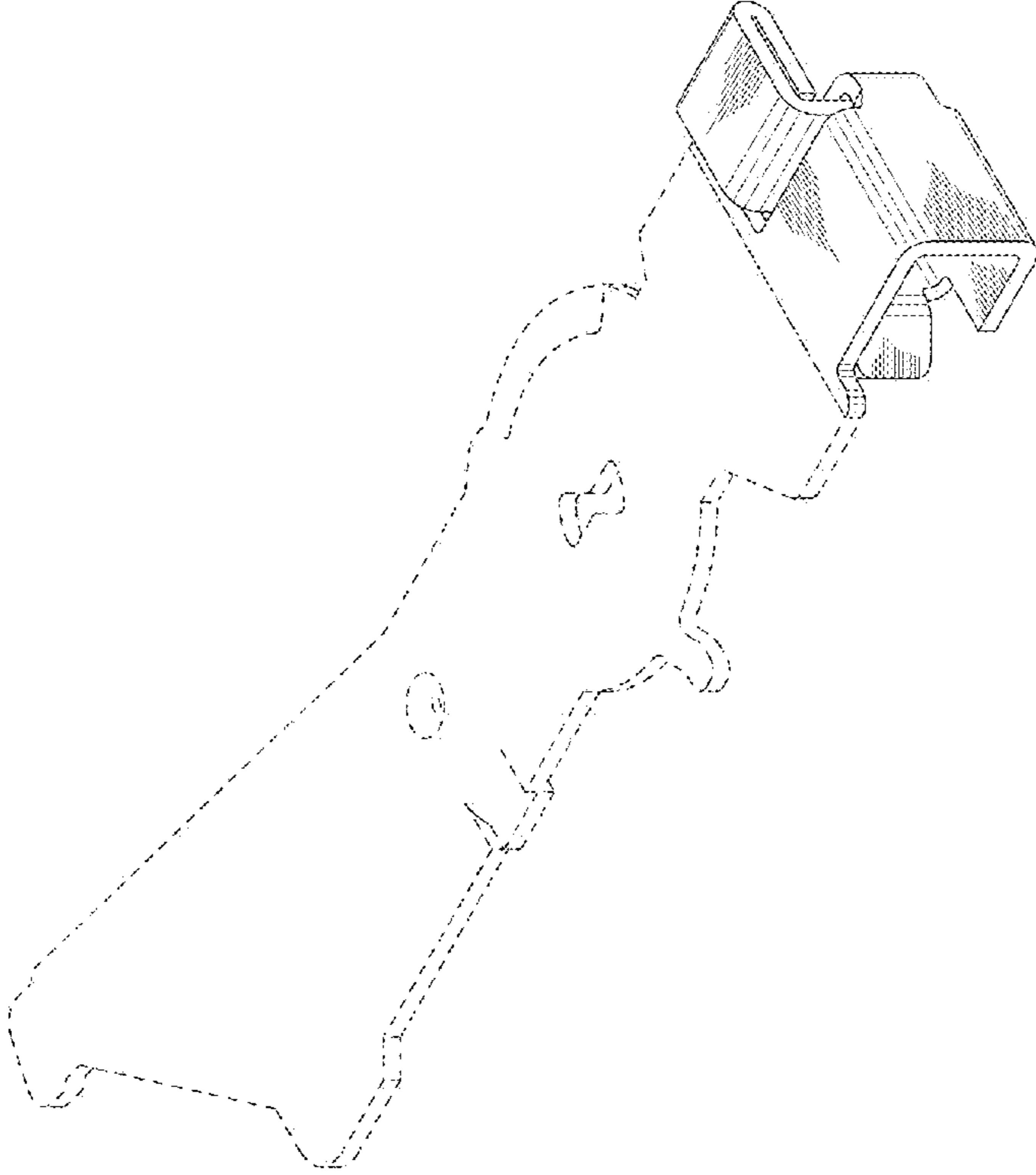

FIG.7



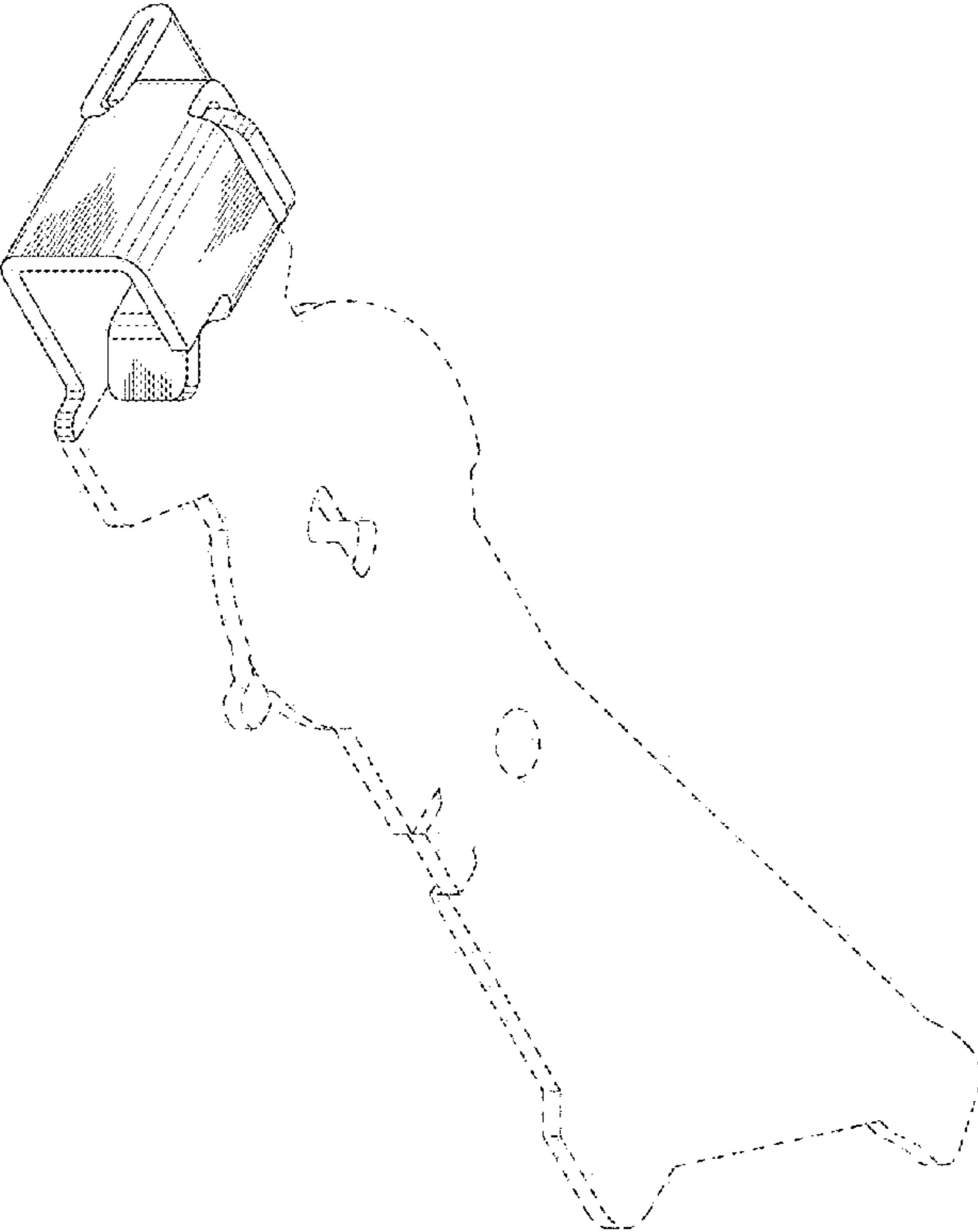

FIG. 8

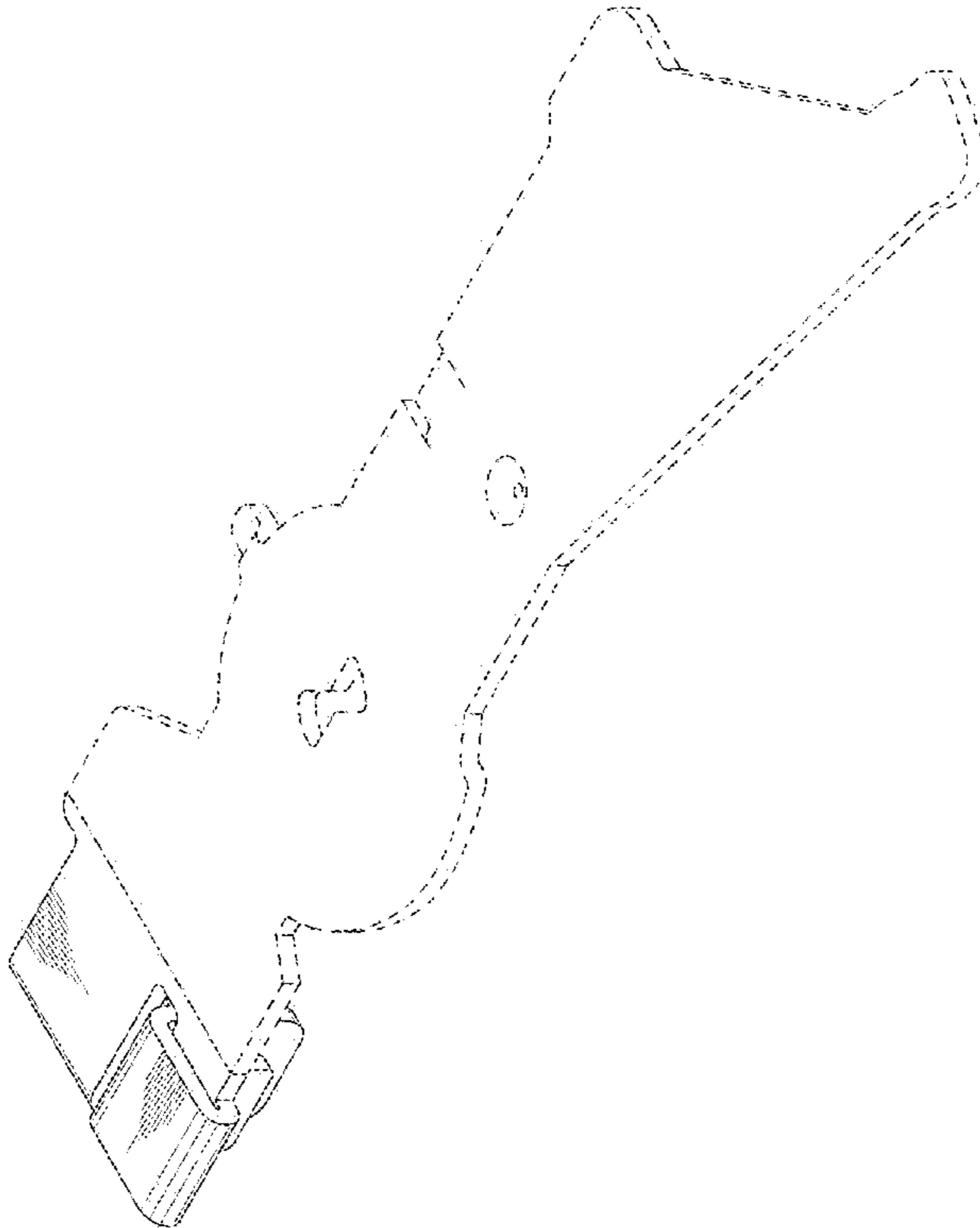

FIG. 9

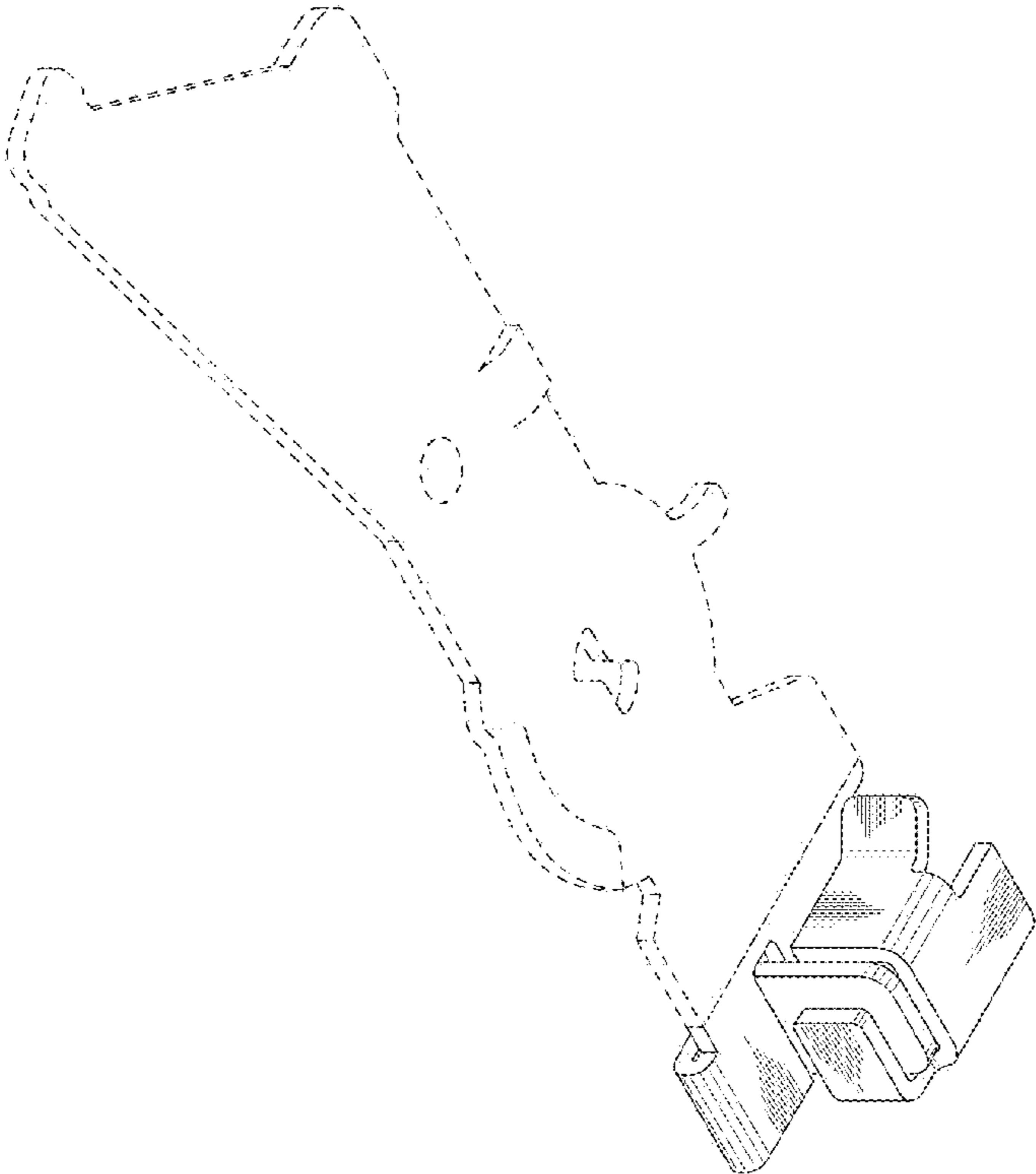

FIG.10