

US00D669058S

(12) **United States Design Patent**
Lee et al.

(10) **Patent No.:** **US D669,058 S**
(45) **Date of Patent:** **** Oct. 16, 2012**

(54) **HEADPHONE**

(75) Inventors: **Noel Lee**, Las Vegas, NV (US); **Jacky Hsiung**, San Jose, CA (US)

(73) Assignee: **Monster Cable Products, Inc.**,
Brisbane, CA (US)

(**) Term: **14 Years**

(21) Appl. No.: **29/400,681**

(22) Filed: **Aug. 31, 2011**

(51) **LOC (9) Cl.** **14-01**

(52) **U.S. Cl.** **D14/223**

(58) **Field of Classification Search** D14/205,
D14/206, 223; 181/129, 130, 135; 379/430,
379/431; 381/380, 381; 455/90.3, 575.2
See application file for complete search history.

(56) **References Cited**

U.S. PATENT DOCUMENTS

5,544,253	A	*	8/1996	Nagayoshi et al.	381/385
D487,078	S	*	2/2004	Chen	D14/223
D563,394	S	*	3/2008	Donaldson et al.	D14/223
D593,537	S	*	6/2009	Arimoto	D14/205
D594,441	S		6/2009	Lee et al.		
D598,901	S		8/2009	Lee et al.		
D599,781	S		9/2009	Lee et al.		
D600,675	S		9/2009	Lee et al.		
D618,211	S	*	6/2010	Oguro et al.	D14/205
D643,417	S		7/2010	Lee et al.		
D643,418	S		7/2010	Lee et al.		
D635,960	S	*	4/2011	Gondo et al.	D14/223
D637,182	S		5/2011	Lee et al.		
D637,585	S	*	5/2011	Nagayama et al.	D14/223
D639,282	S	*	6/2011	Ohori et al.	D14/223
D640,241	S	*	6/2011	Wai	D14/223
D641,008	S		7/2011	Lee et al.		
D641,011	S	*	7/2011	Gondo	D14/223
D642,163	S		7/2011	Lee et al.		
D643,833	S		8/2011	Lee et al.		

D644,212	S	*	8/2011	Quek	D14/223
D644,213	S	*	8/2011	Quek	D14/223
D645,456	S	*	9/2011	Carr et al.	D14/223
D645,457	S	*	9/2011	Carr et al.	D14/223
D649,957	S	*	12/2011	Fahrendorff et al.	D14/223
D652,822	S	*	1/2012	Lee et al.	D14/223
D652,823	S	*	1/2012	Chen	D14/223

* cited by examiner

Primary Examiner — Paula Greene

(74) *Attorney, Agent, or Firm* — LaRiviere, Grubman & Payne, LLP

(57) **CLAIM**

The ornamental design for a headphone, as shown and described.

DESCRIPTION

FIG. 1 is a perspective view of a headphone, in a closed housing condition, showing our design;
 FIG. 2 is an opposing perspective view thereof;
 FIG. 3 is front view thereof;
 FIG. 4 is a rear view thereof;
 FIG. 5 is a side view thereof;
 FIG. 6 is an opposing side view thereof;
 FIG. 7 is a top view thereof;
 FIG. 8 is a bottom view thereof;
 FIG. 9 is a perspective view of a headphone, in an open housing condition, showing our design;
 FIG. 10 is an opposing perspective view thereof;
 FIG. 11 is front view thereof;
 FIG. 12 is a rear view thereof;
 FIG. 13 is a side view thereof;
 FIG. 14 is an opposing side view thereof;
 FIG. 15 is a top view thereof; and,
 FIG. 16 is a bottom view thereof.
 The broken lines showing the environment are for illustrative purposes only and form no part of the claimed design.

1 Claim, 8 Drawing Sheets

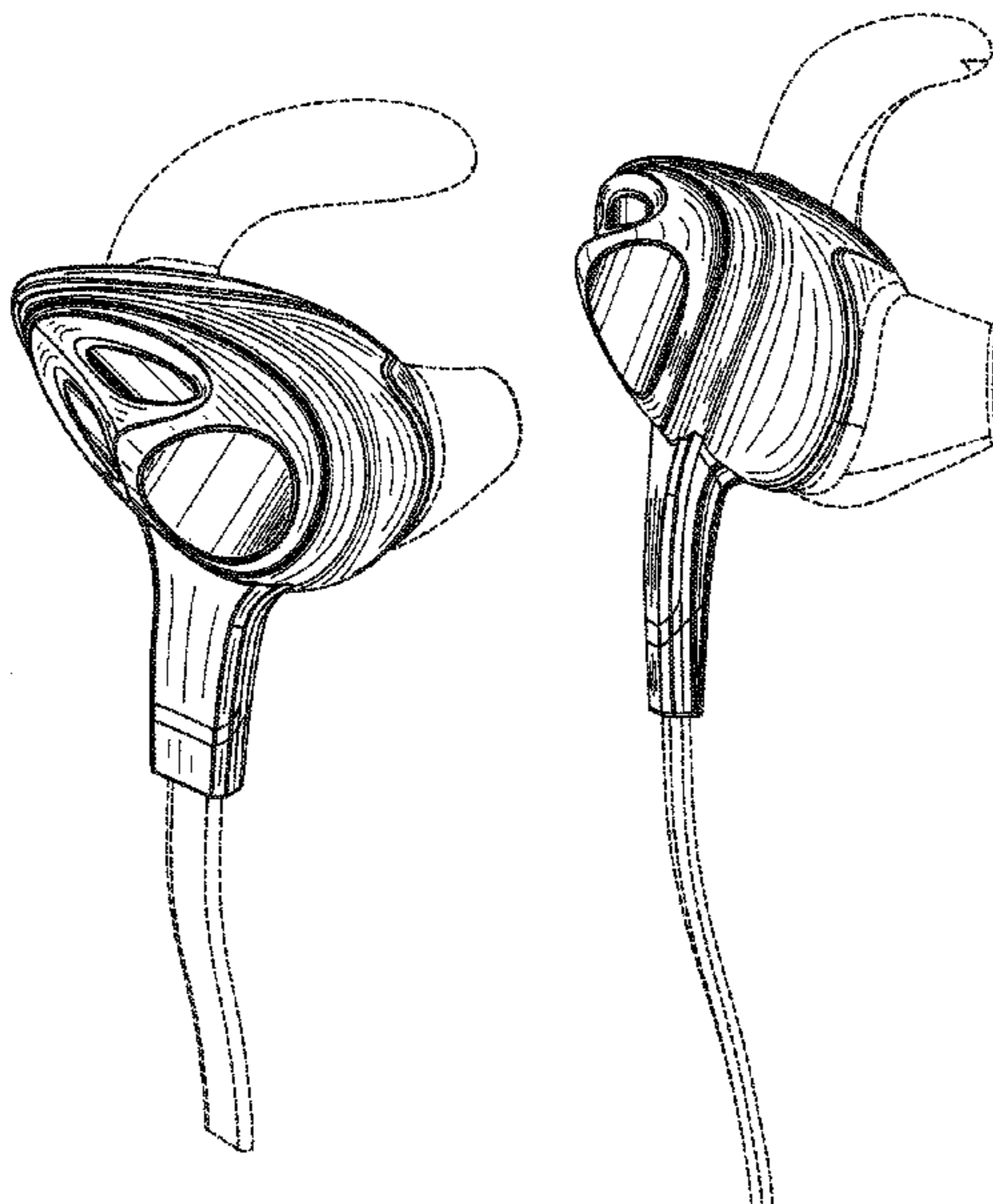

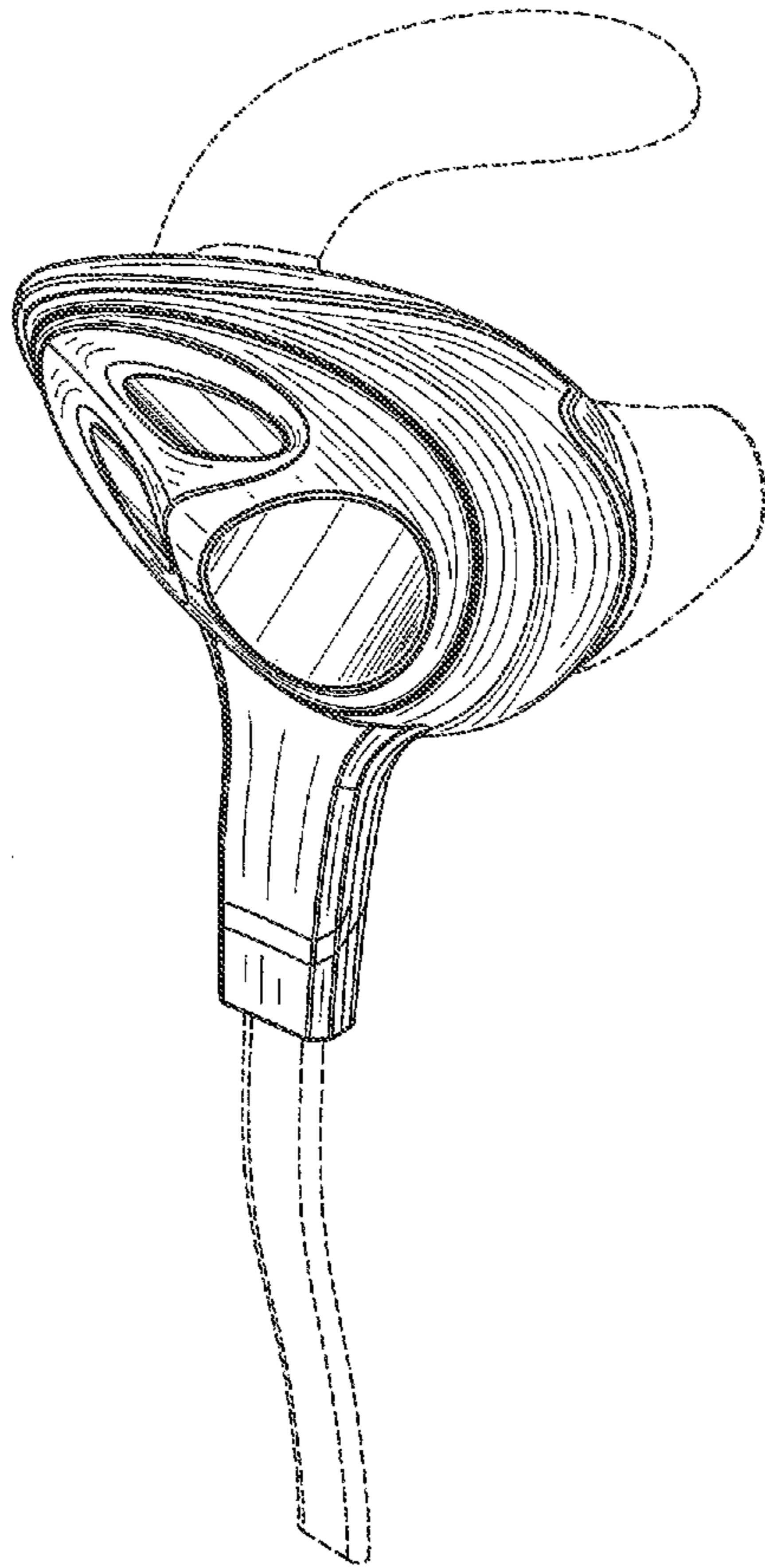

Figure 1

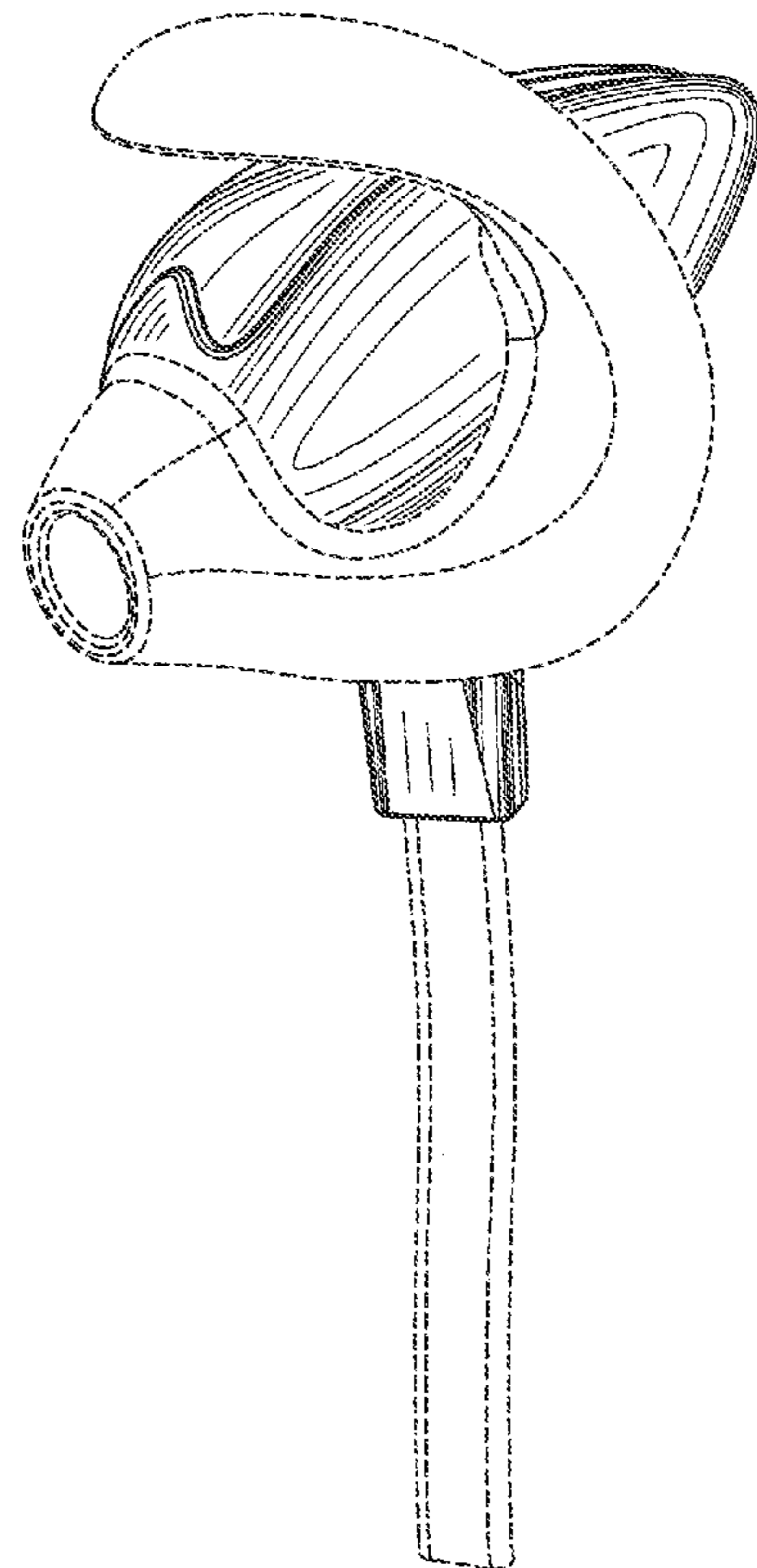

Figure 2

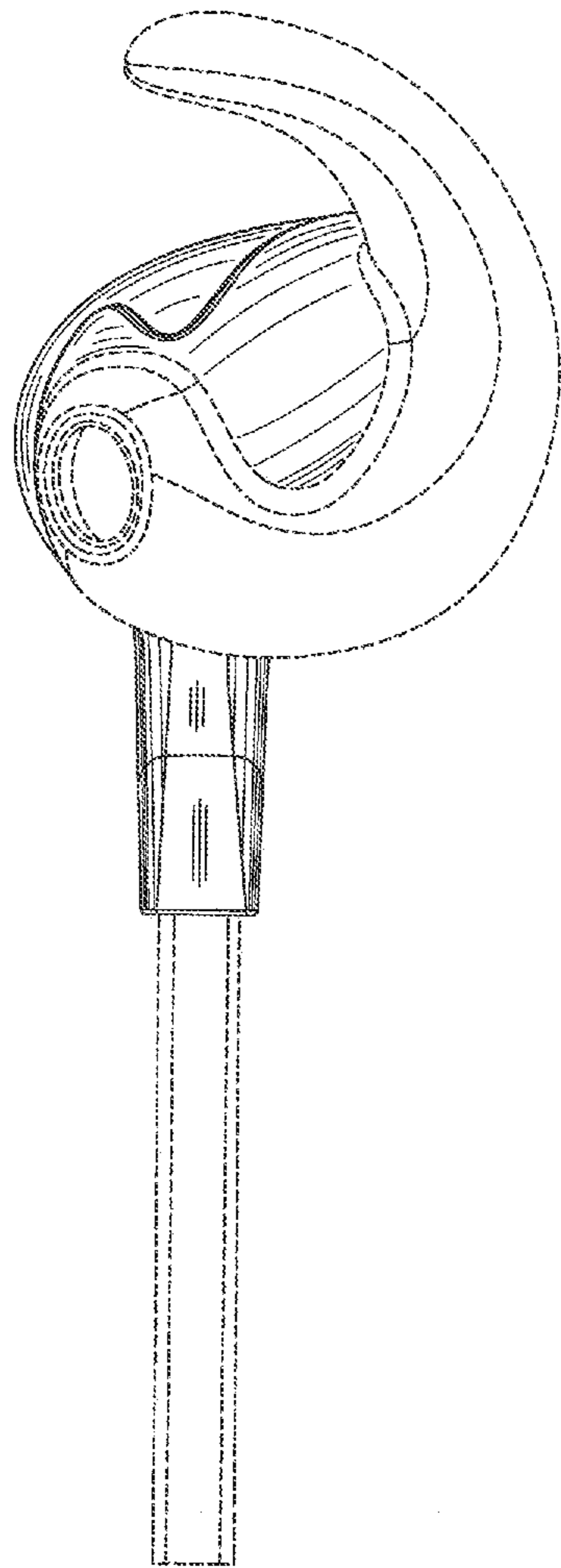

Figure 3

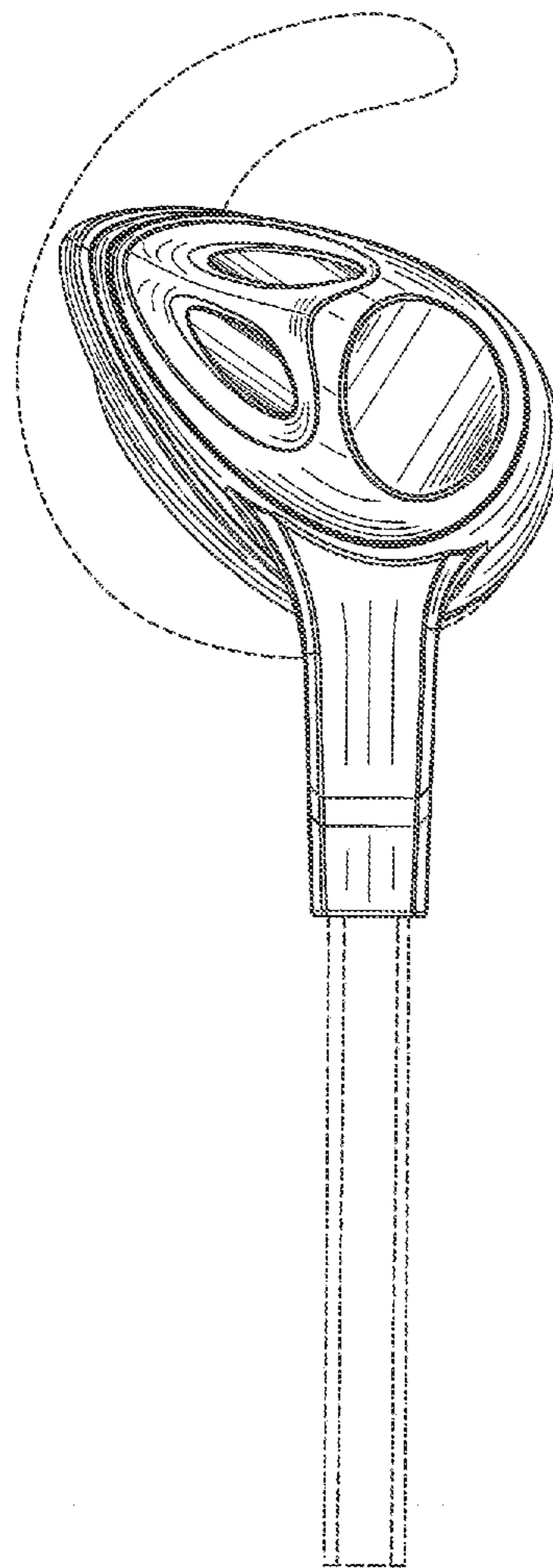

Figure 4

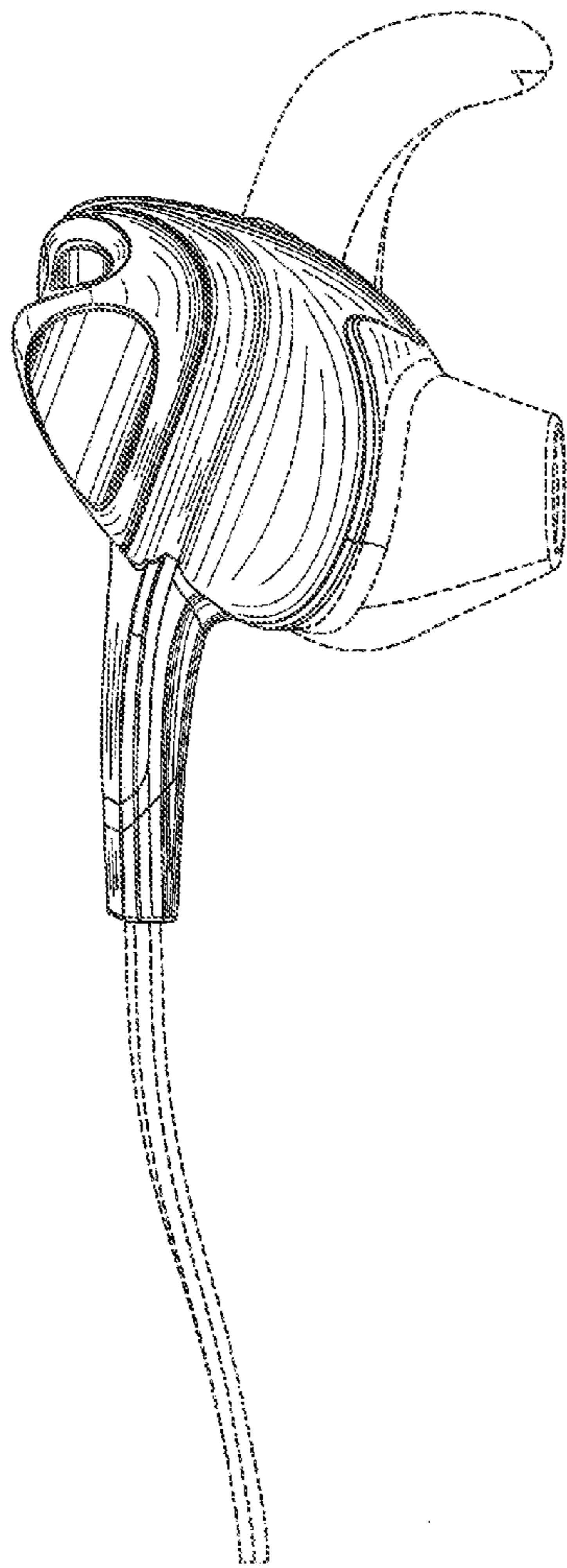

Figure 5

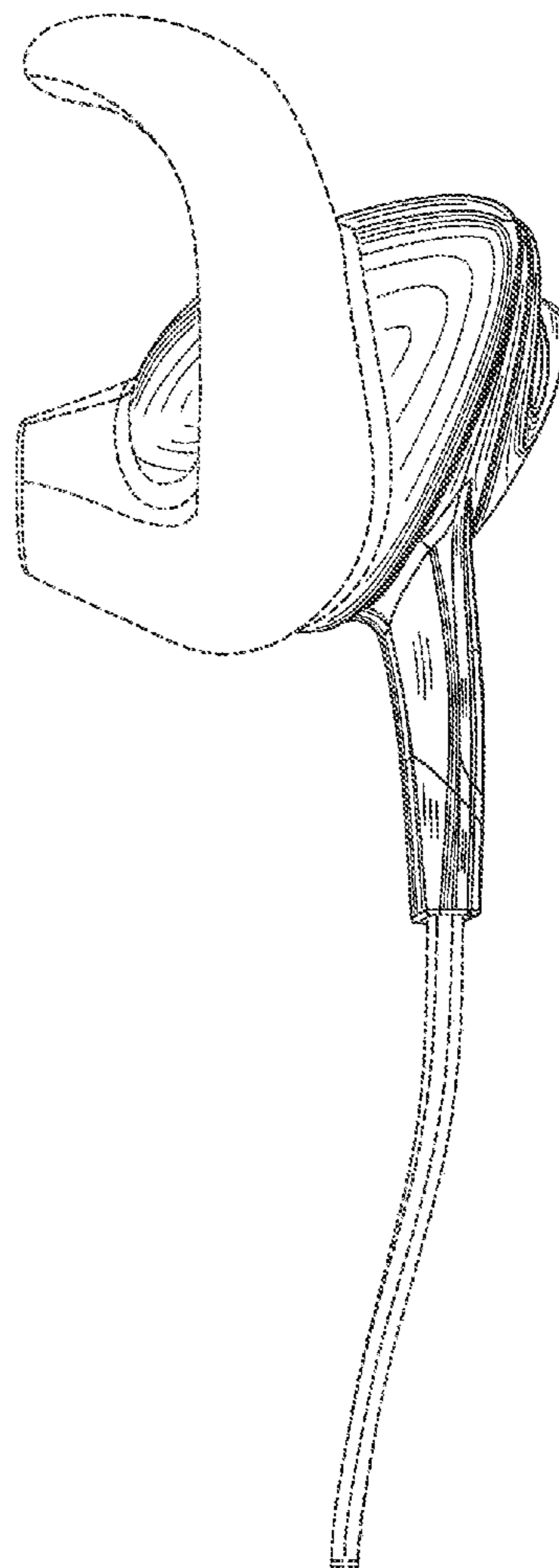

Figure 6

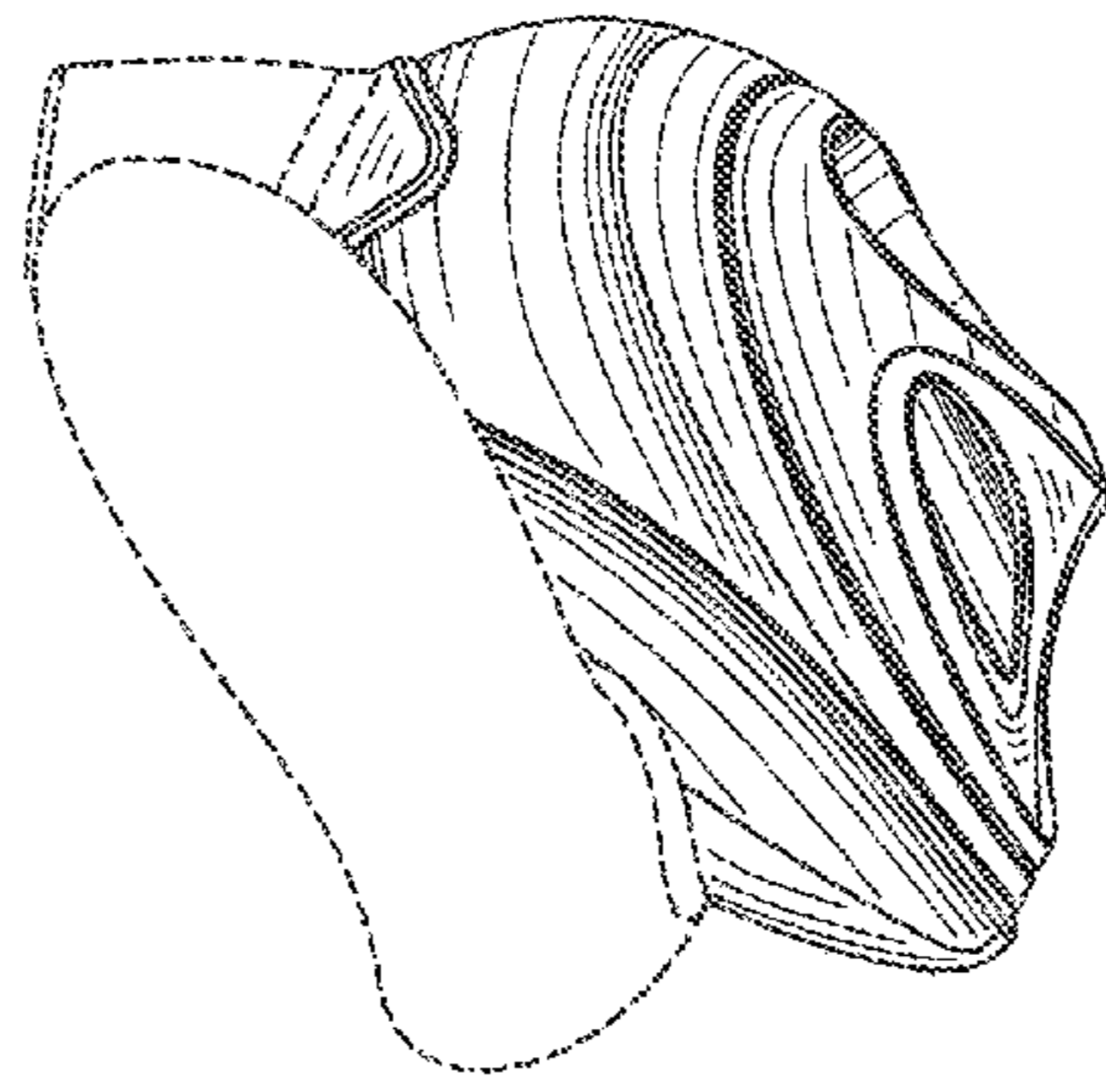

Figure 7

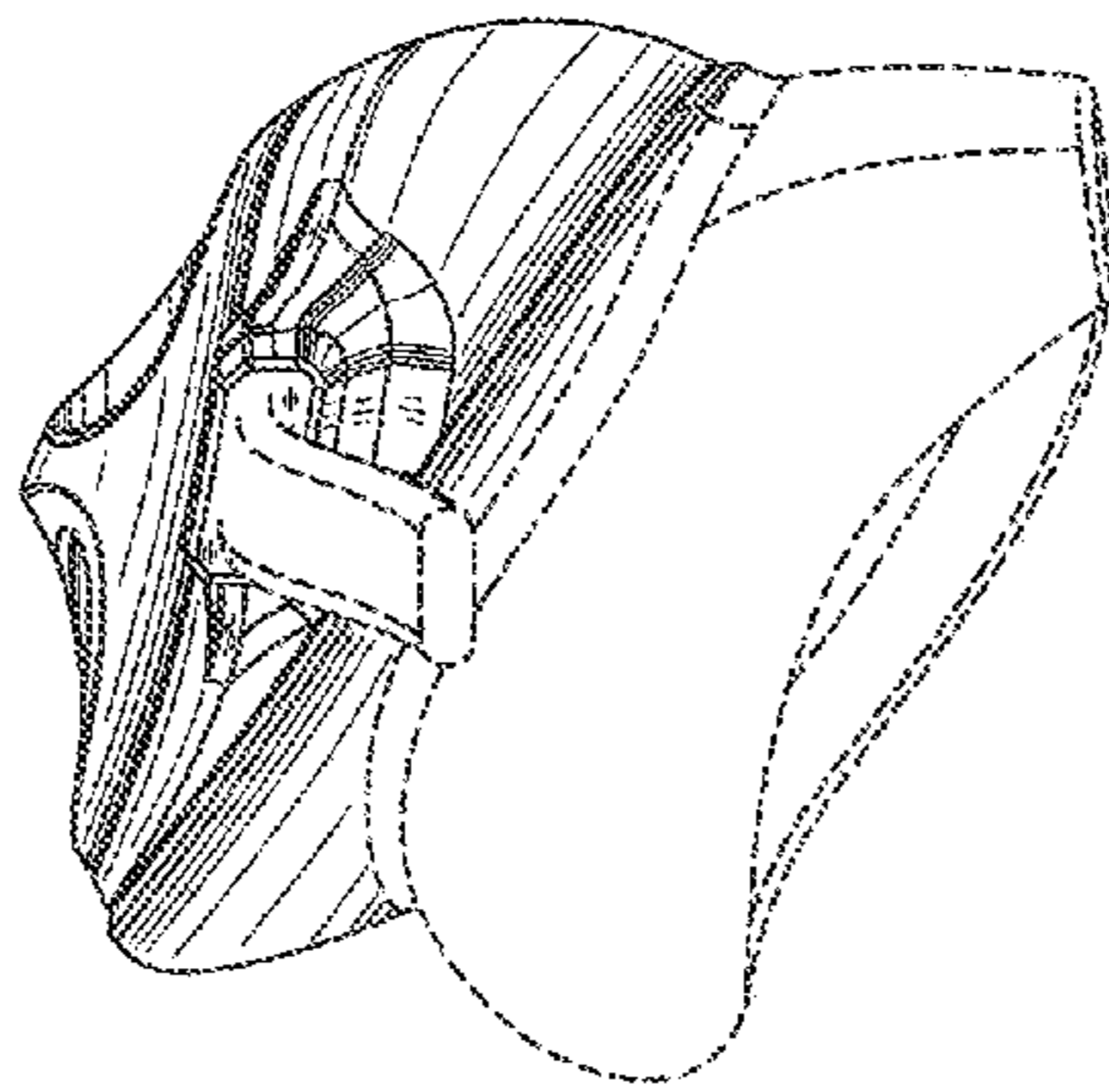

Figure 8

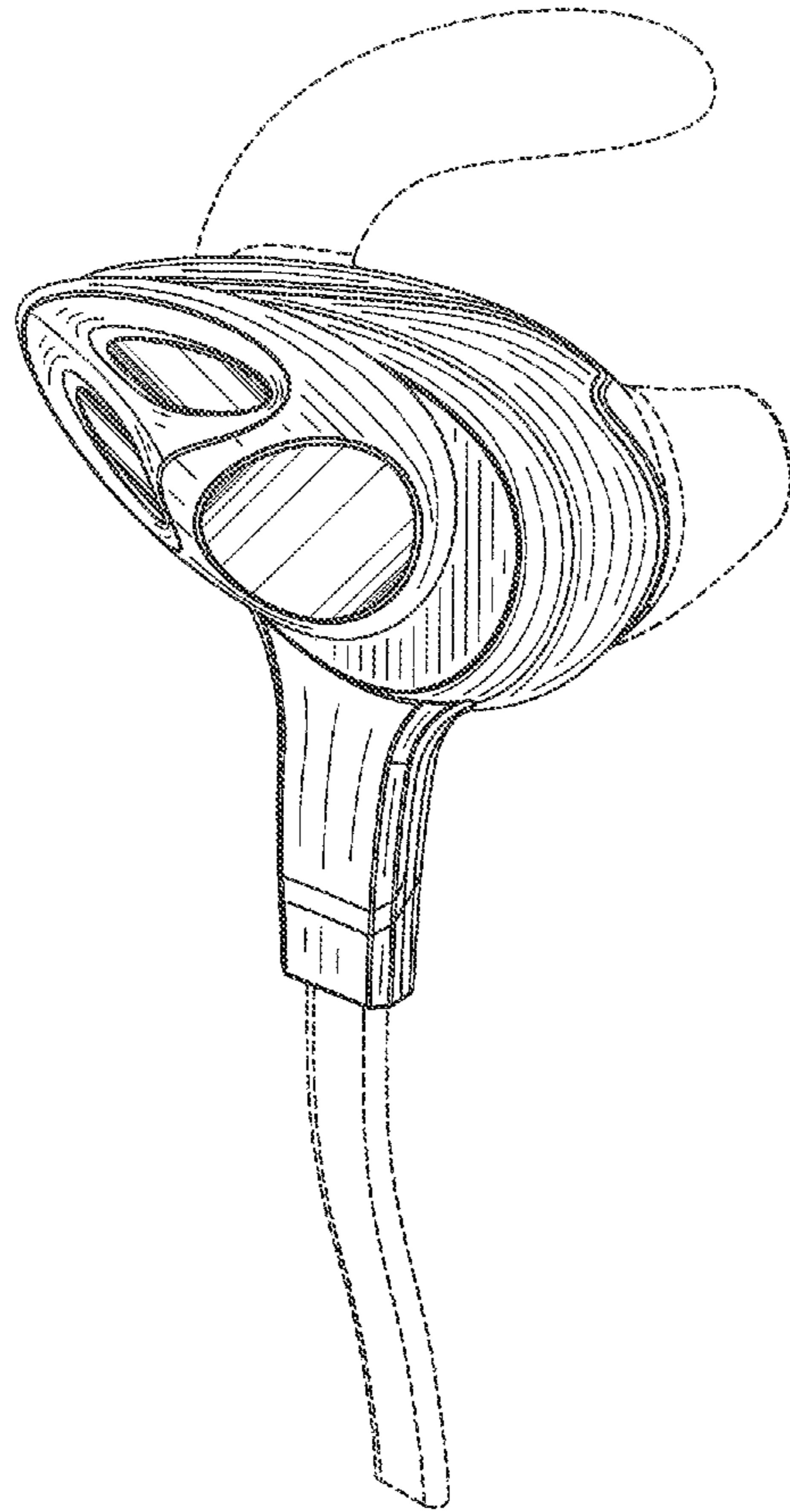

Figure 9

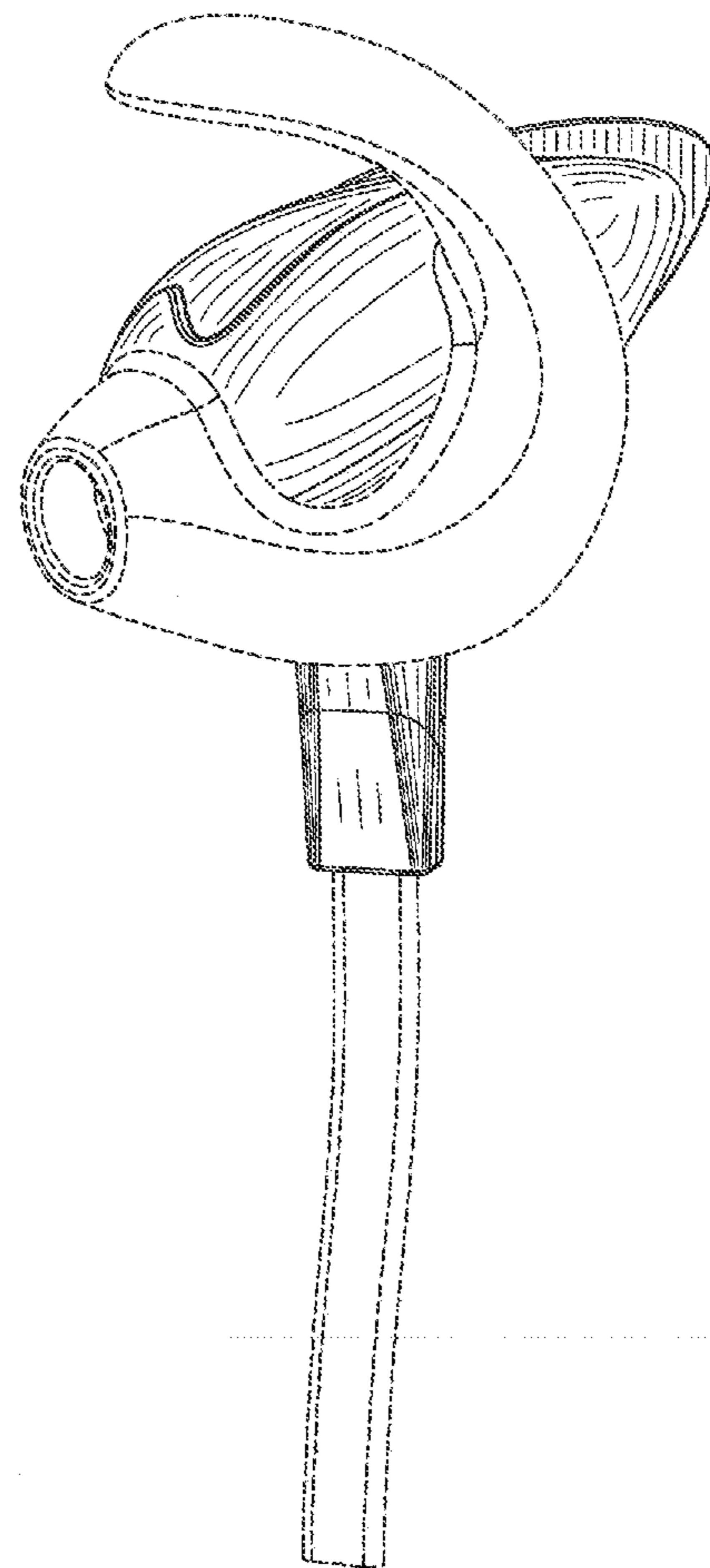

Figure 10

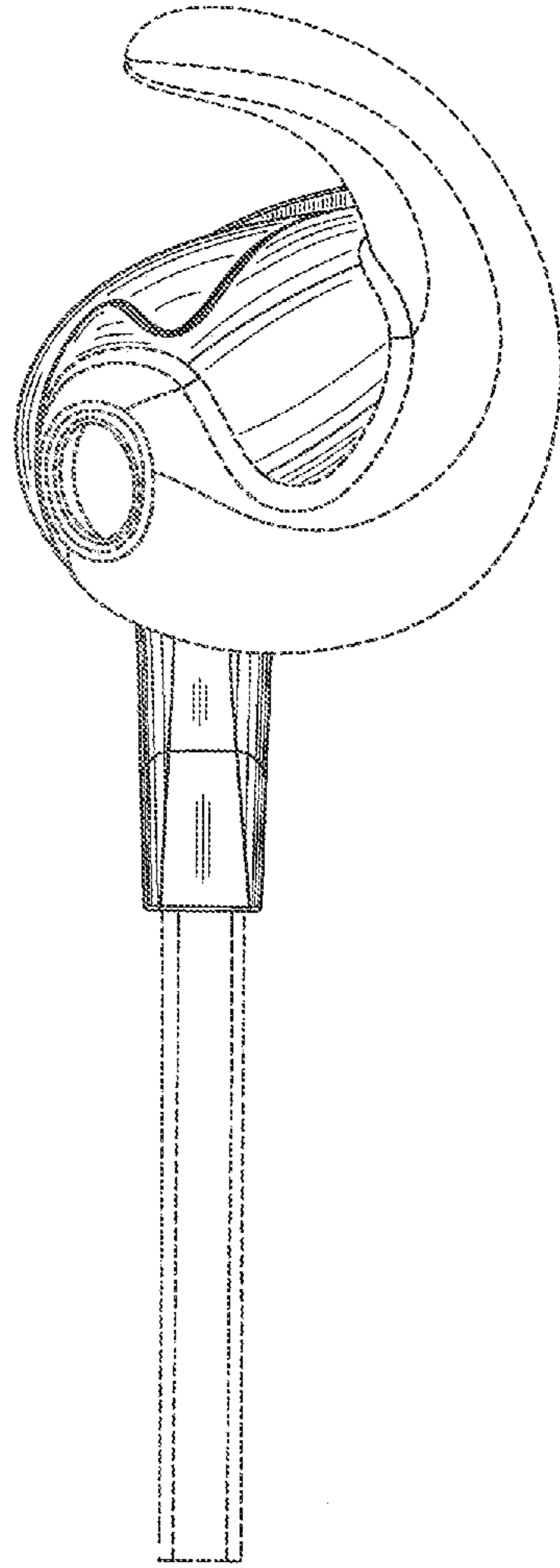

Figure 11

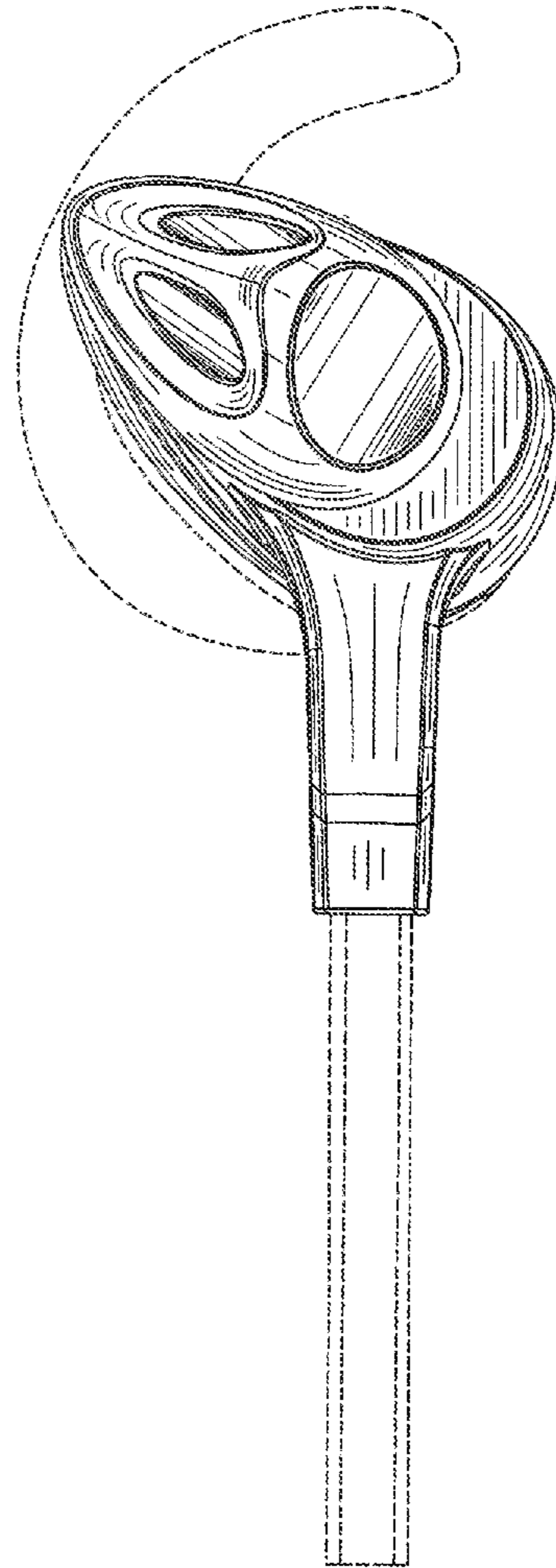

Figure 12

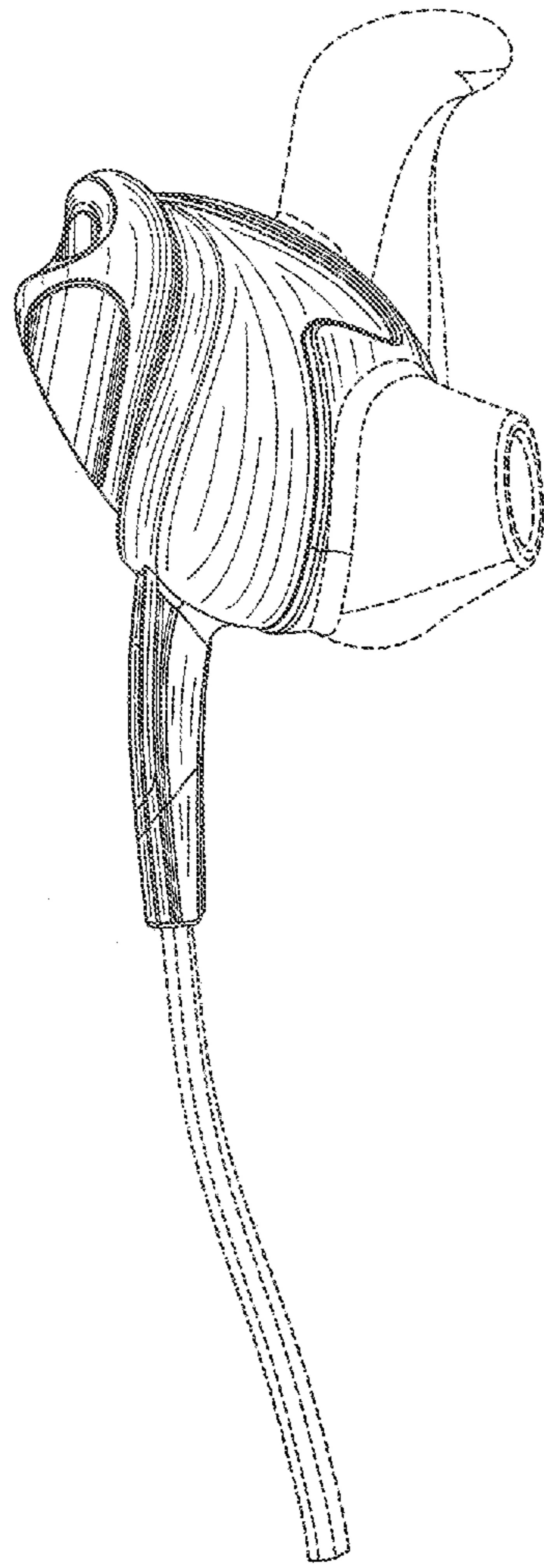

Figure 13

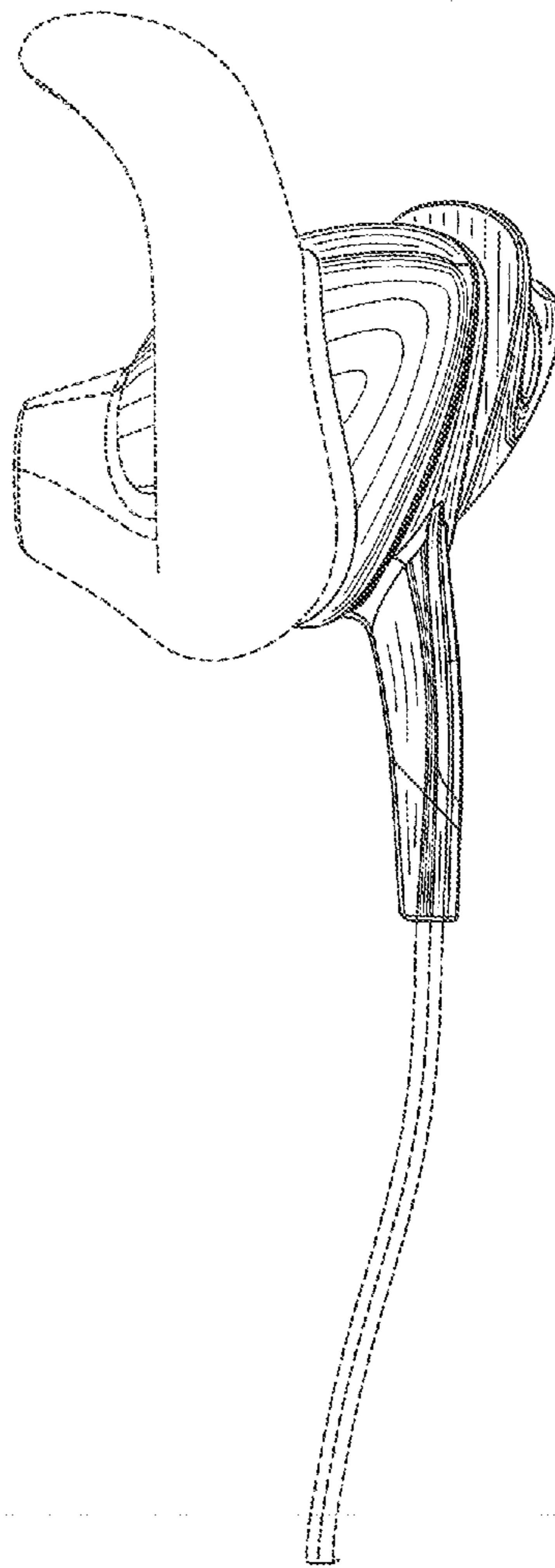

Figure 14

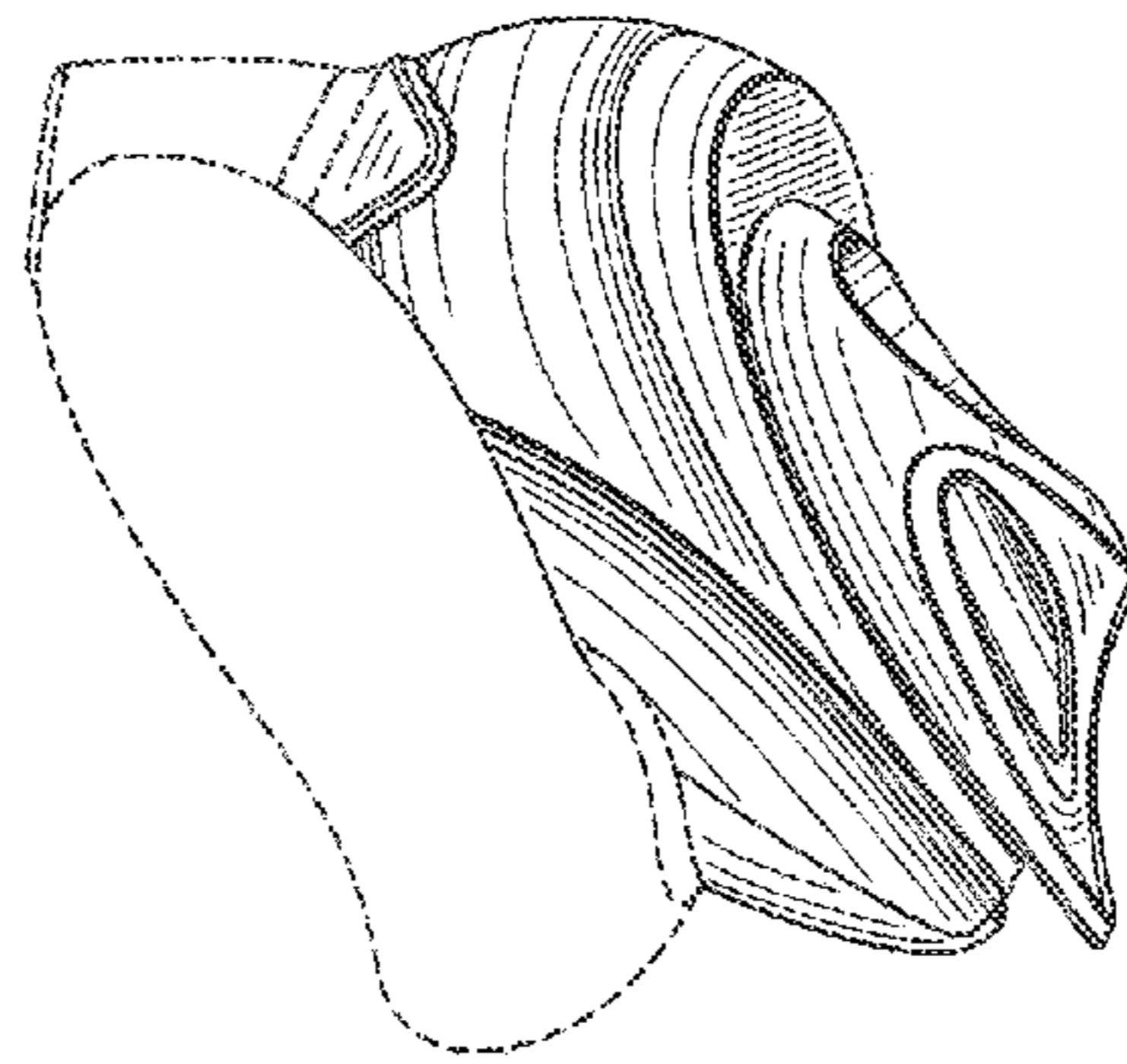

Figure 15

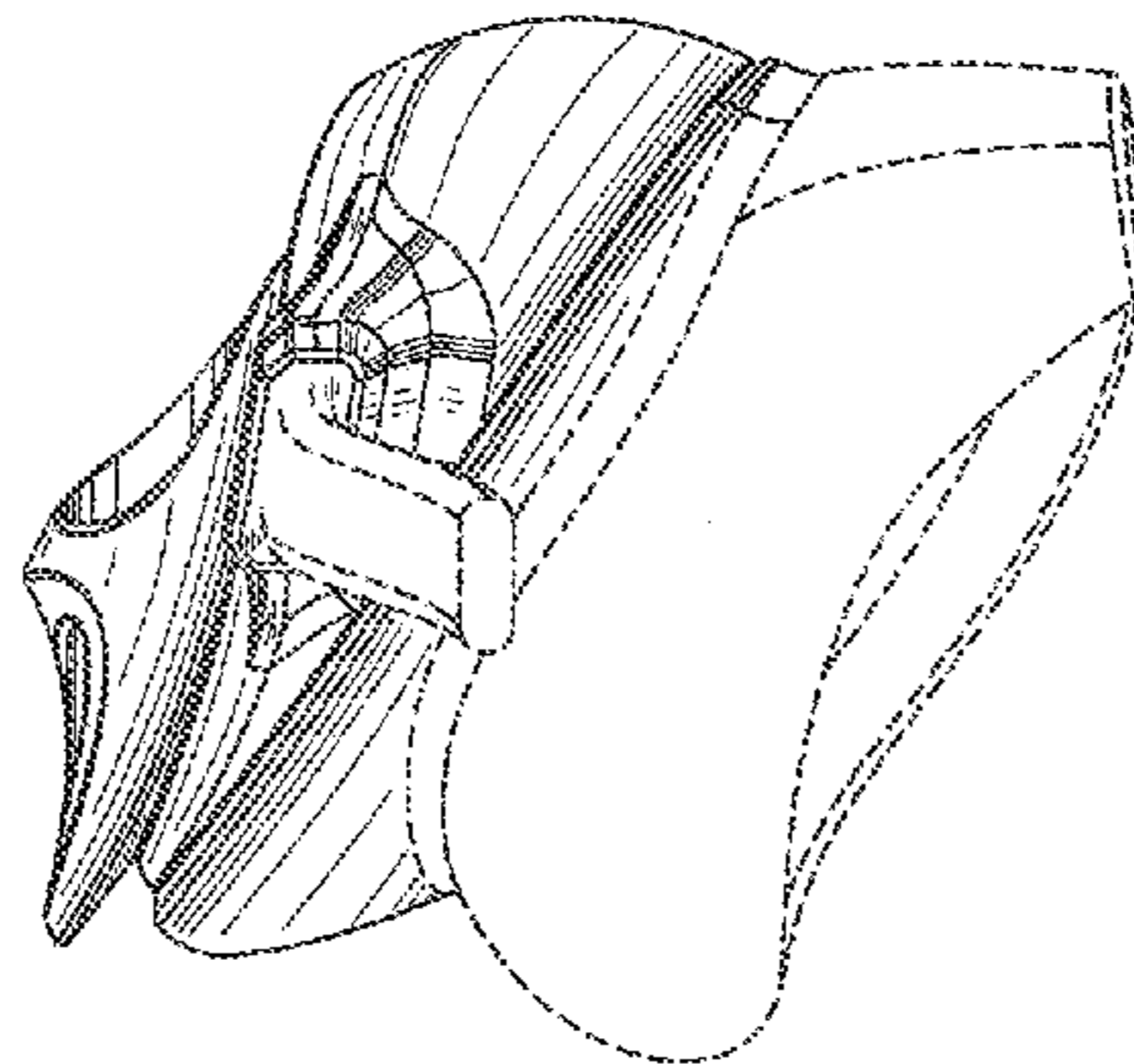

Figure 16