



US00D668888S

(12) **United States Design Patent**
Key

(10) **Patent No.:** **US D668,888 S**
(45) **Date of Patent:** **** Oct. 16, 2012**

- (54) **WIG CHIFFAROBE CABINET**
- (76) Inventor: **Carol Key**, Kennesaw, GA (US)
- (**) Term: **14 Years**
- (21) Appl. No.: **29/392,464**
- (22) Filed: **May 20, 2011**
- (51) **LOC (9) Cl.** **06-04**
- (52) **U.S. Cl.** **D6/445**
- (58) **Field of Classification Search** D6/432,
D6/436, 437-440, 445, 446, 447, 448; 312/107,
312/109, 114, 118, 138.1, 204, 237, 249.8,
312/257.1, 321.5
See application file for complete search history.

(56) **References Cited**

U.S. PATENT DOCUMENTS

1,975,779	A *	10/1934	Church	312/321.5
D197,753	S	3/1964	Kosi		
3,289,823	A	12/1966	Weiser et al.		
D207,939	S	6/1967	Weiser		
3,338,388	A	8/1967	Igoe		
D209,563	S	12/1967	Friedman		
3,396,832	A	8/1968	Bloom et al.		
3,403,953	A *	10/1968	Clark	312/204
3,438,480	A	4/1969	Chabrelot		
3,506,112	A	4/1970	Feinberg		
3,587,836	A	6/1971	Brown		
3,621,988	A	11/1971	Songer		
3,658,174	A	4/1972	Friedman		
3,715,028	A	2/1973	Schumer		
3,728,003	A	4/1973	Bohannon		
3,770,114	A	11/1973	Jackson		
3,891,082	A	6/1975	Fall		
4,069,853	A	1/1978	Surabian		
4,126,213	A	11/1978	McDonald		
D339,685	S	9/1993	Perkins		
D397,262	S *	8/1998	Thomas	D6/446
D411,918	S	7/1999	Neuman		

D435,741	S *	1/2001	Schlereth	D6/446
D445,597	S *	7/2001	Stone et al.	D6/446
D465,649	S	11/2002	Sharples		
D499,275	S *	12/2004	Grosfillex	D6/446
D499,276	S *	12/2004	Grosfillex	D6/446
D516,835	S *	3/2006	Netto et al.	D6/446
D526,816	S *	8/2006	Nowotarski et al.	D6/446
D527,927	S *	9/2006	Nowotarski et al.	D6/446
D532,626	S *	11/2006	McDiarmid et al.	D6/446
D532,627	S *	11/2006	Nowotarski et al.	D6/446
D625,122	S *	10/2010	Cartaya, III	D6/445

* cited by examiner

Primary Examiner — Mimoso De

(74) *Attorney, Agent, or Firm* — QuickPatents, Inc.; Kevin Prince

(57) **CLAIM**

I claim the ornamental design for a wig chiffarobe cabinet, as shown and described.

DESCRIPTION

FIG. 1 is a perspective view of a wig chiffarobe cabinet, showing my new design in a closed position; FIG. 2 is a left-side elevational view thereof; FIG. 3 is a front elevational view thereof; FIG. 4 is a right-side elevational view thereof; FIG. 5 is a rear elevational view thereof; FIG. 6 is a bottom plan view thereof; FIG. 7 is a top plan view thereof; FIG. 8 is a perspective view thereof, showing both doors open; FIG. 9 is a front elevational view of FIG. 8; and, FIG. 10 is a left-side elevational view of FIG. 8, the right-side elevational view being a mirror image thereof. The broken lines showing mannequines and wigs in FIG. 8 depict environmental matter and form no part of the claimed design.

1 Claim, 3 Drawing Sheets

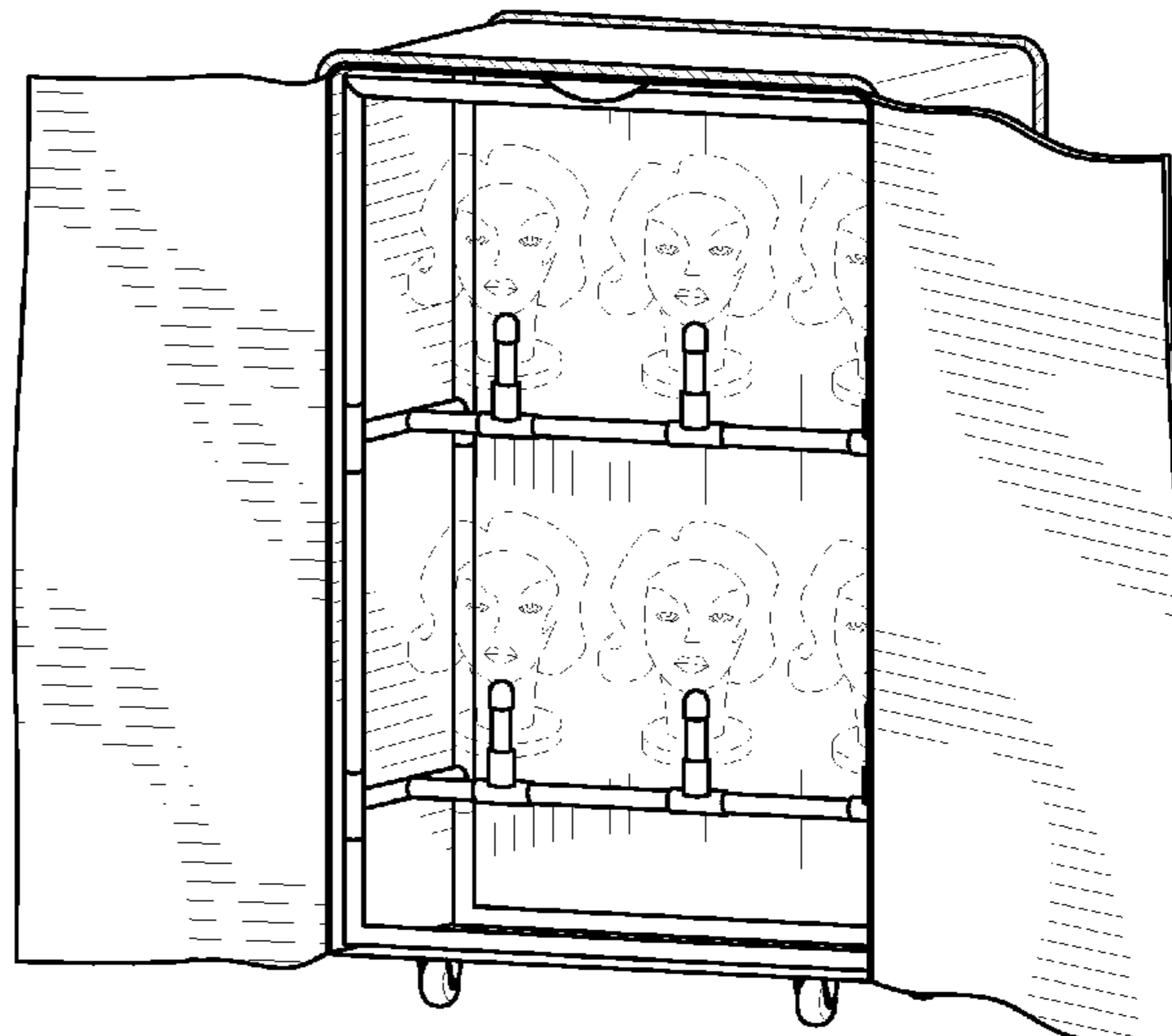
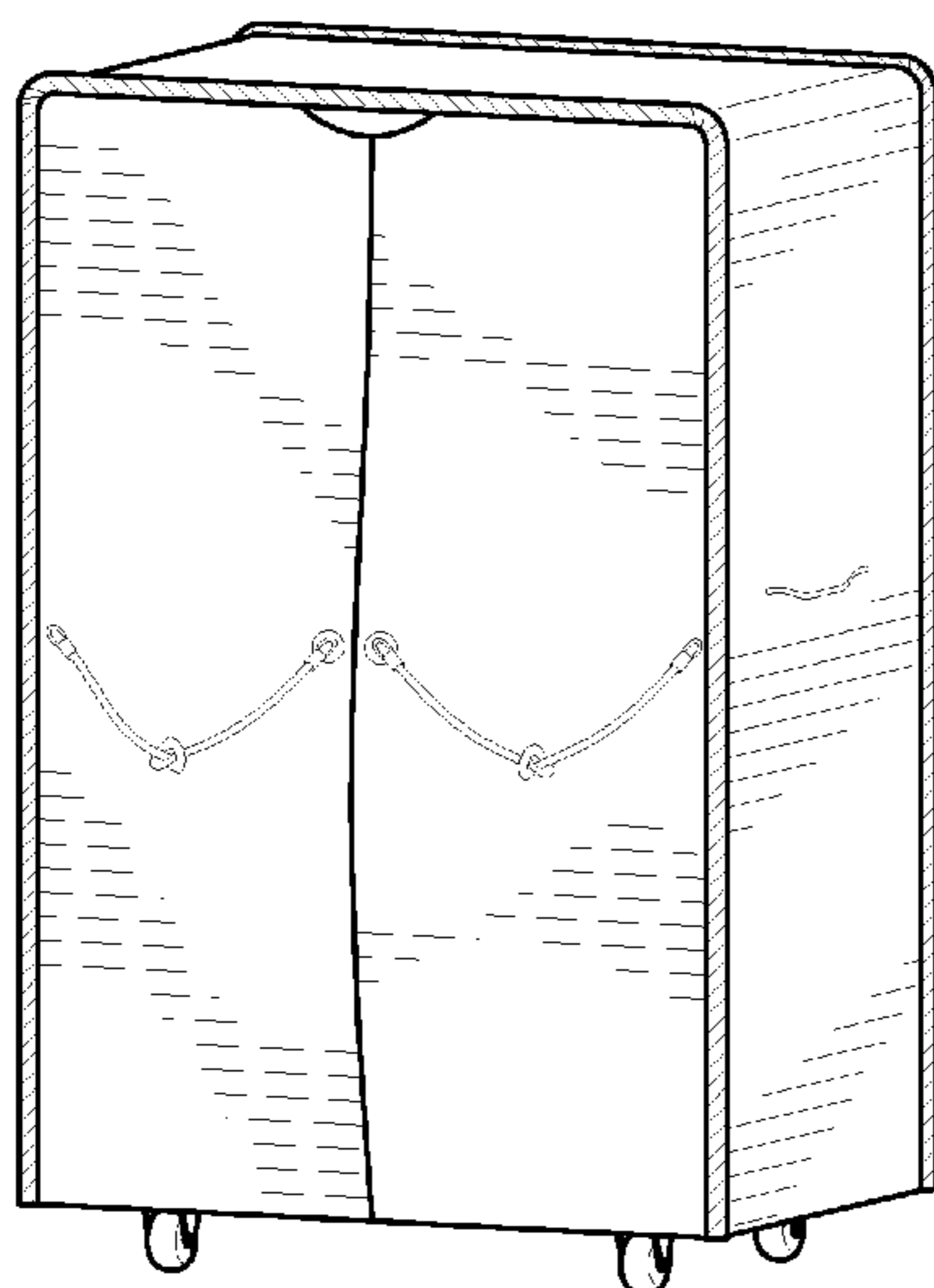

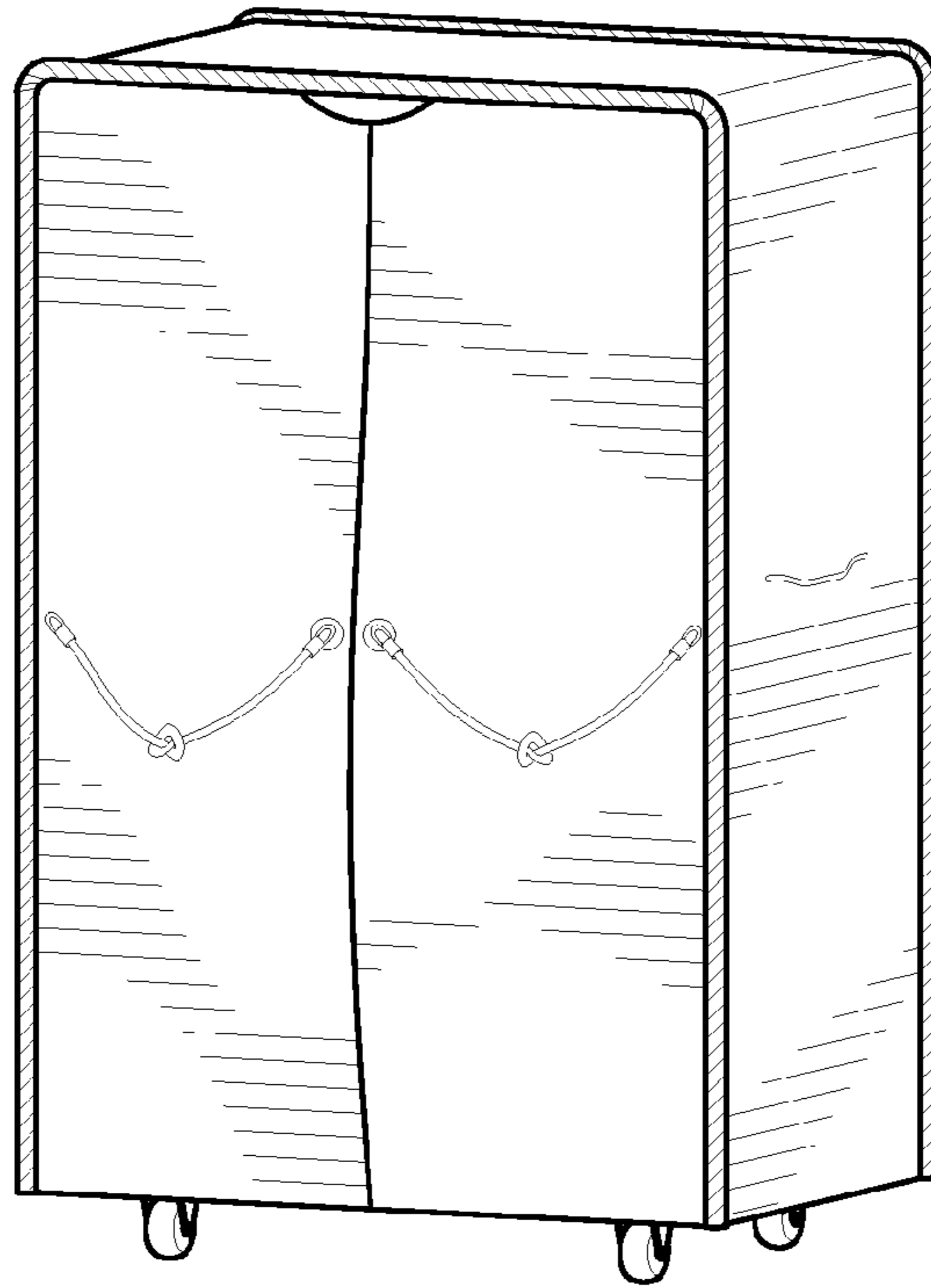

FIG. 1

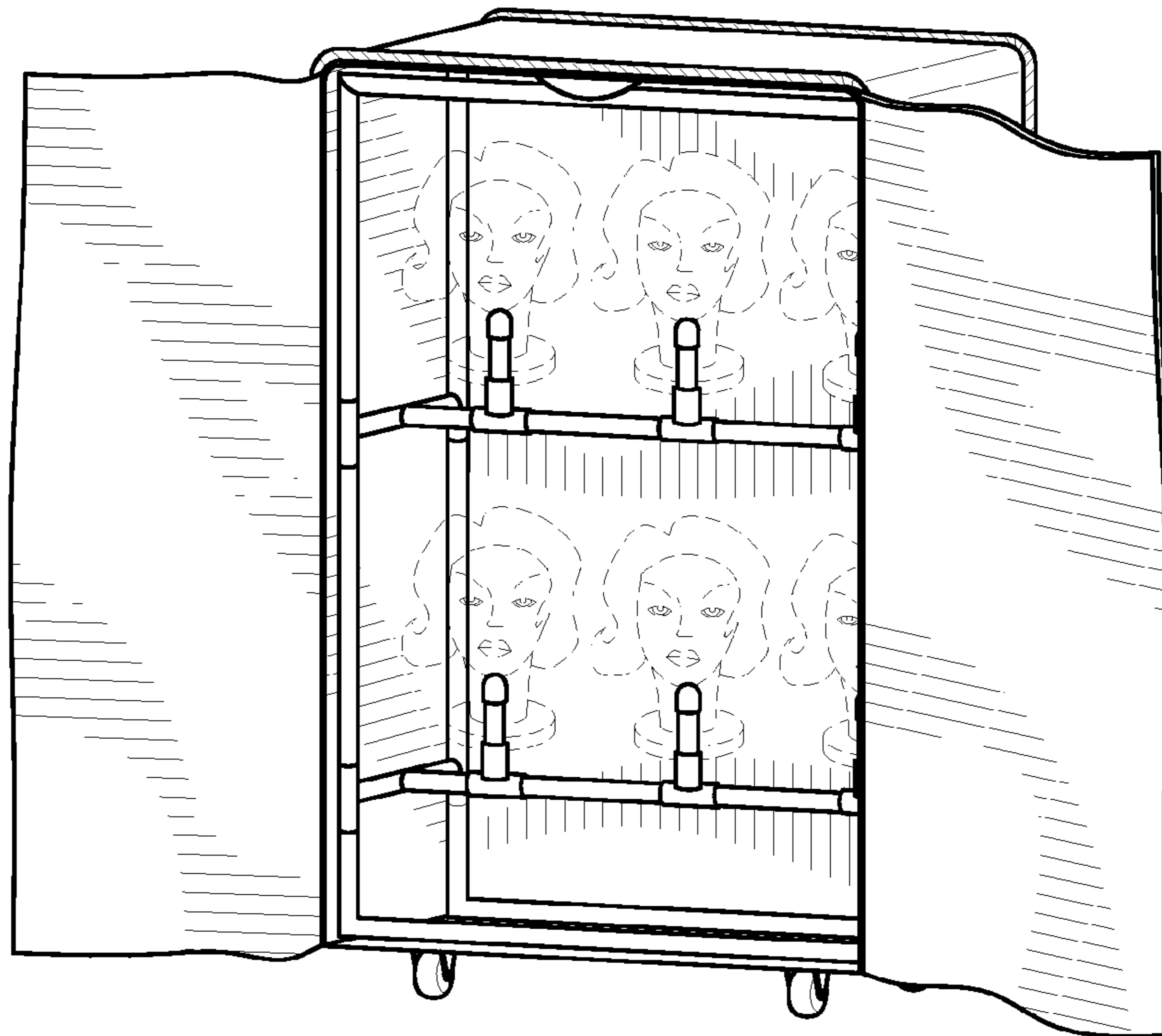

FIG. 8

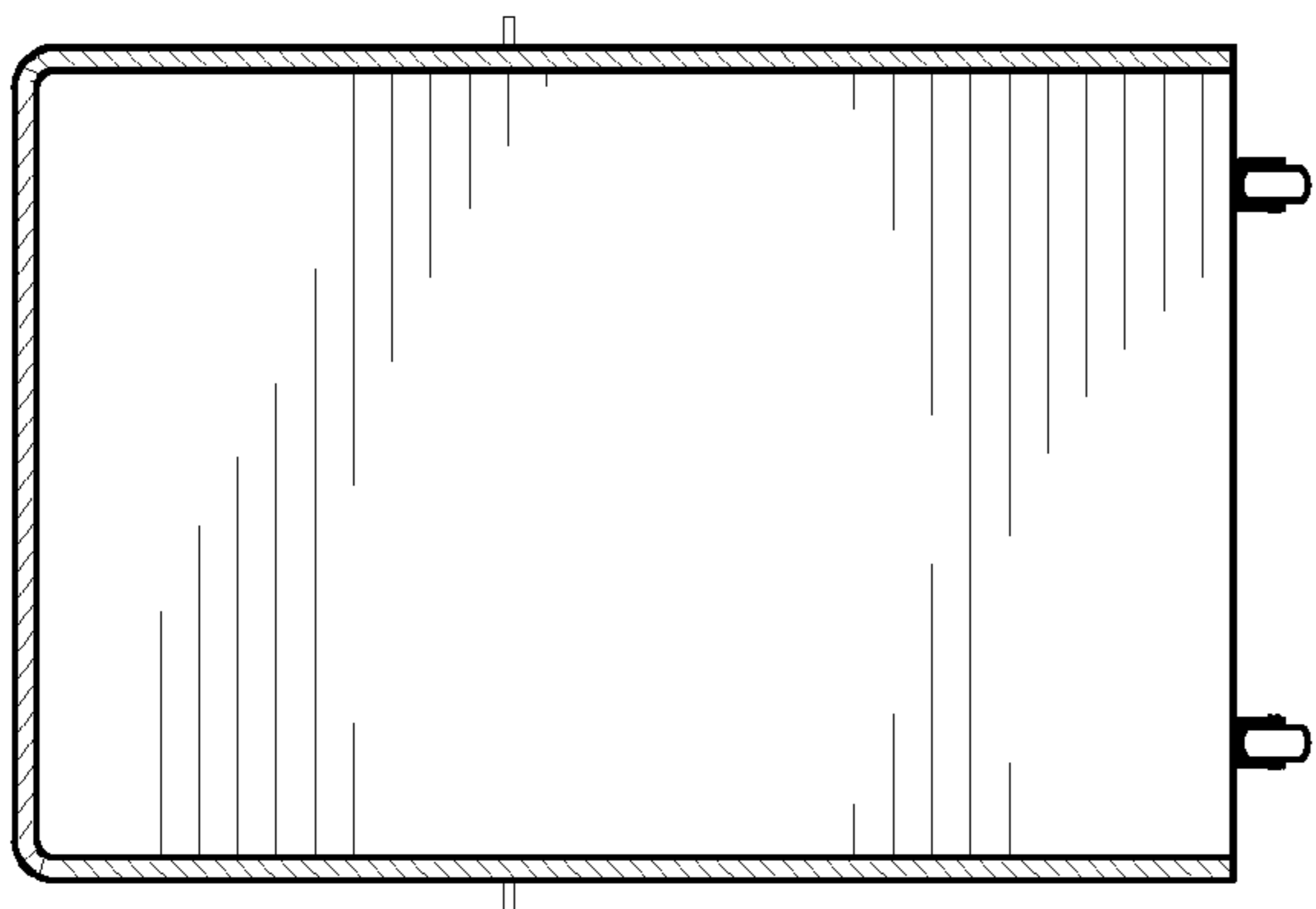

FIG. 5

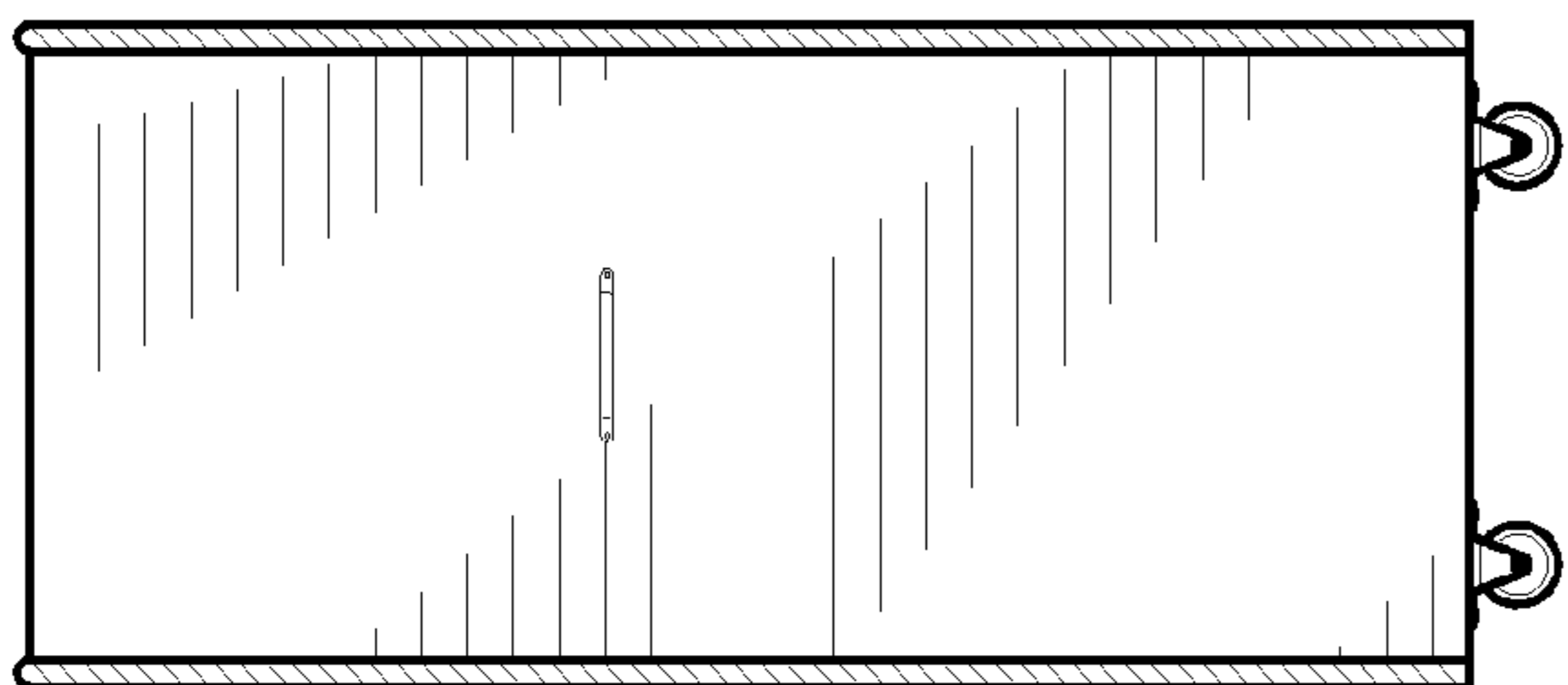

FIG. 4

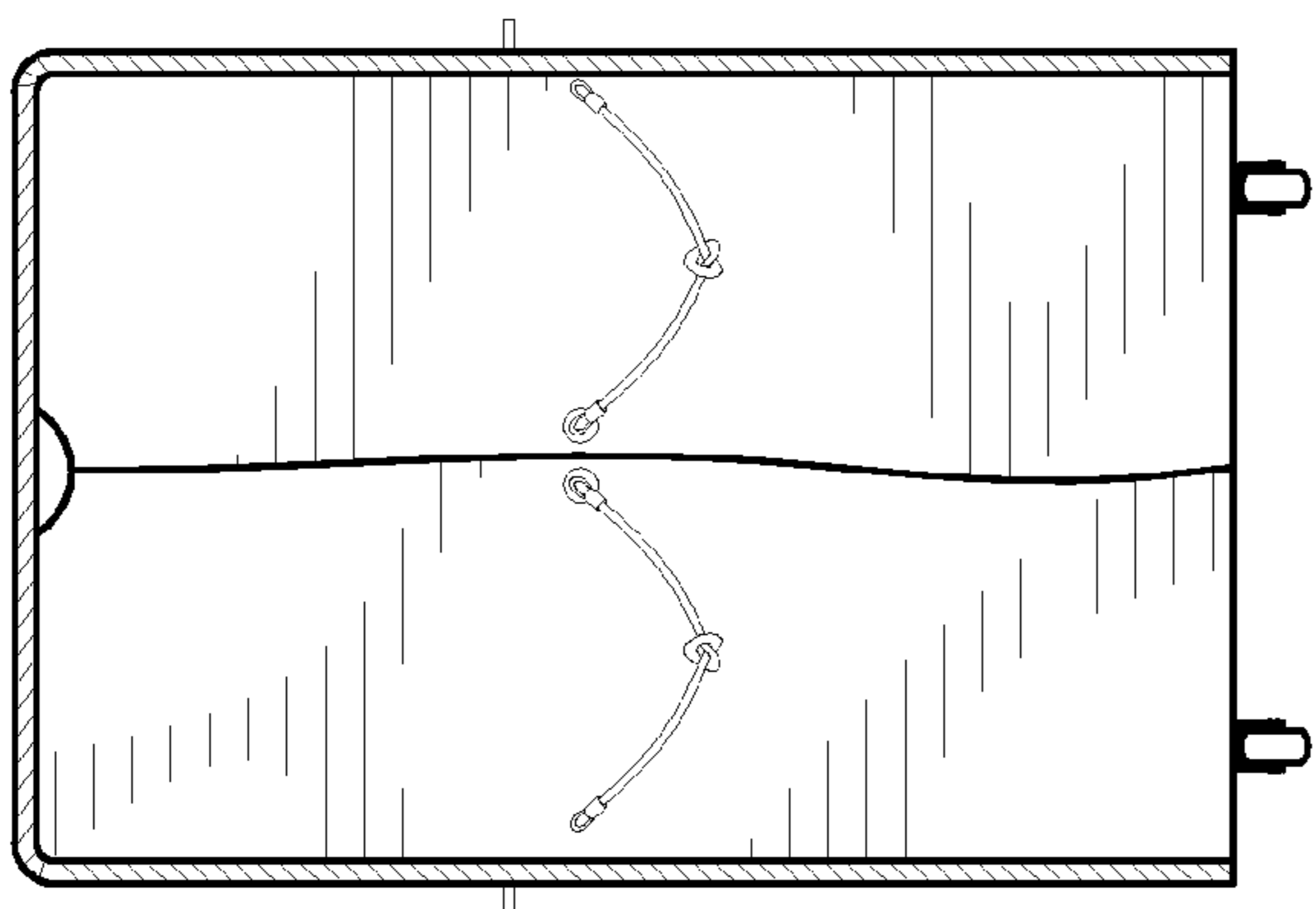

FIG. 3

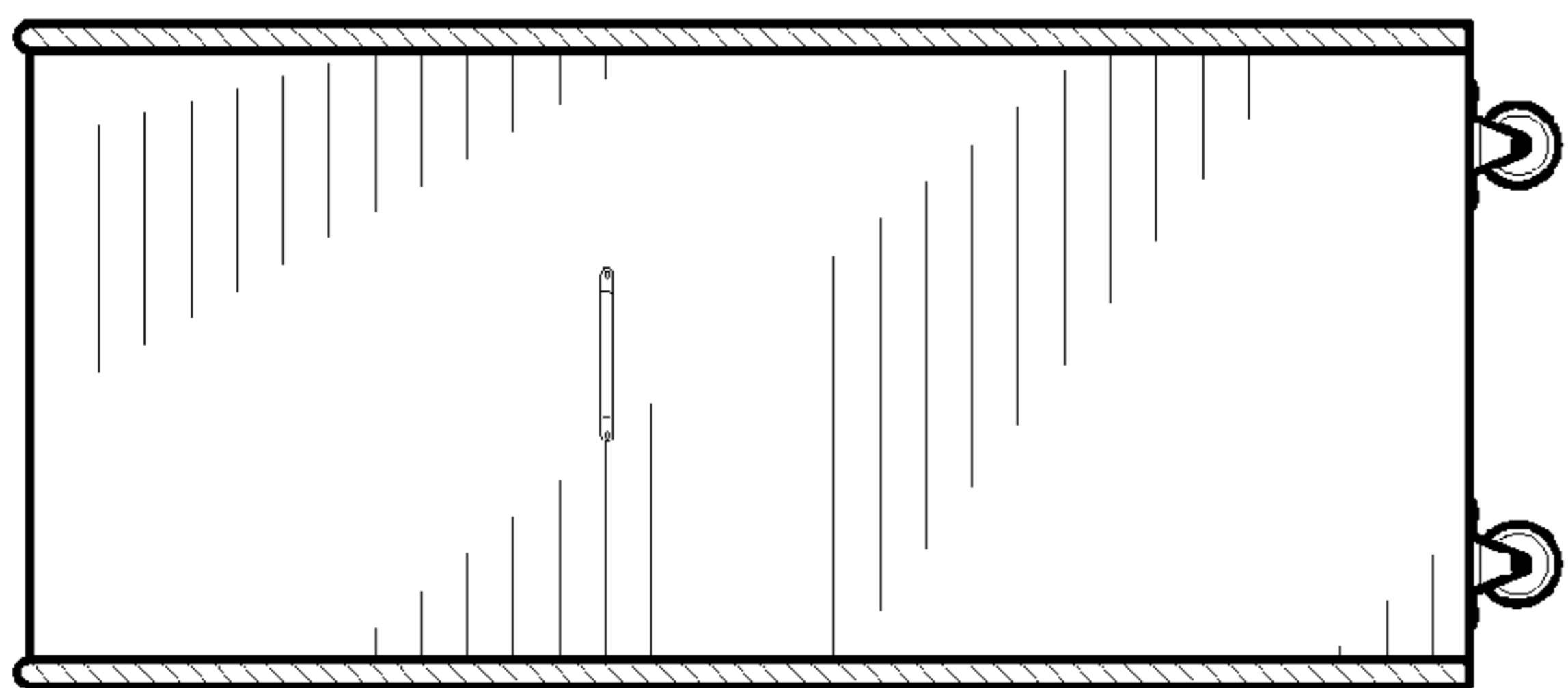

FIG. 2

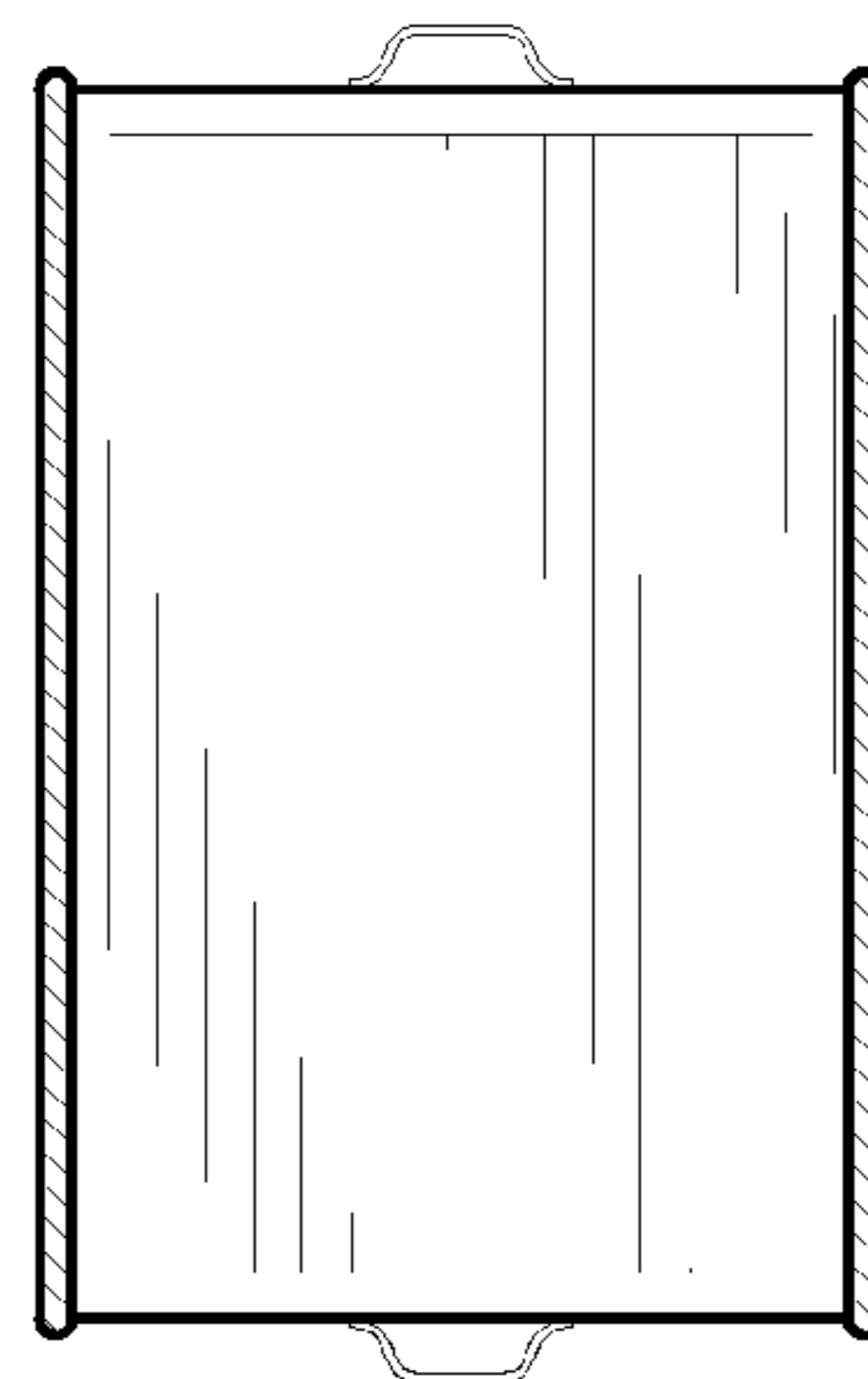

FIG. 7

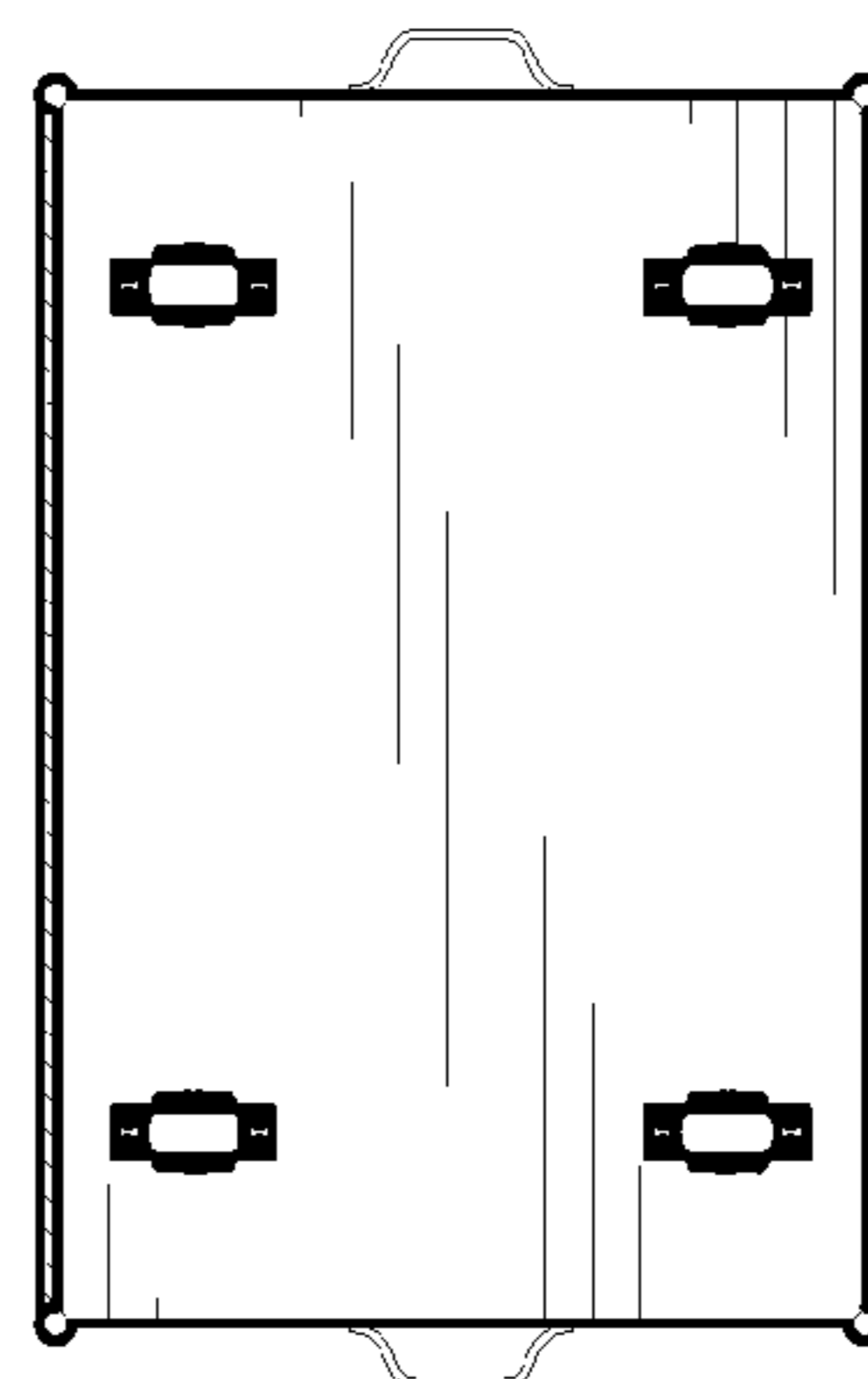

FIG. 6

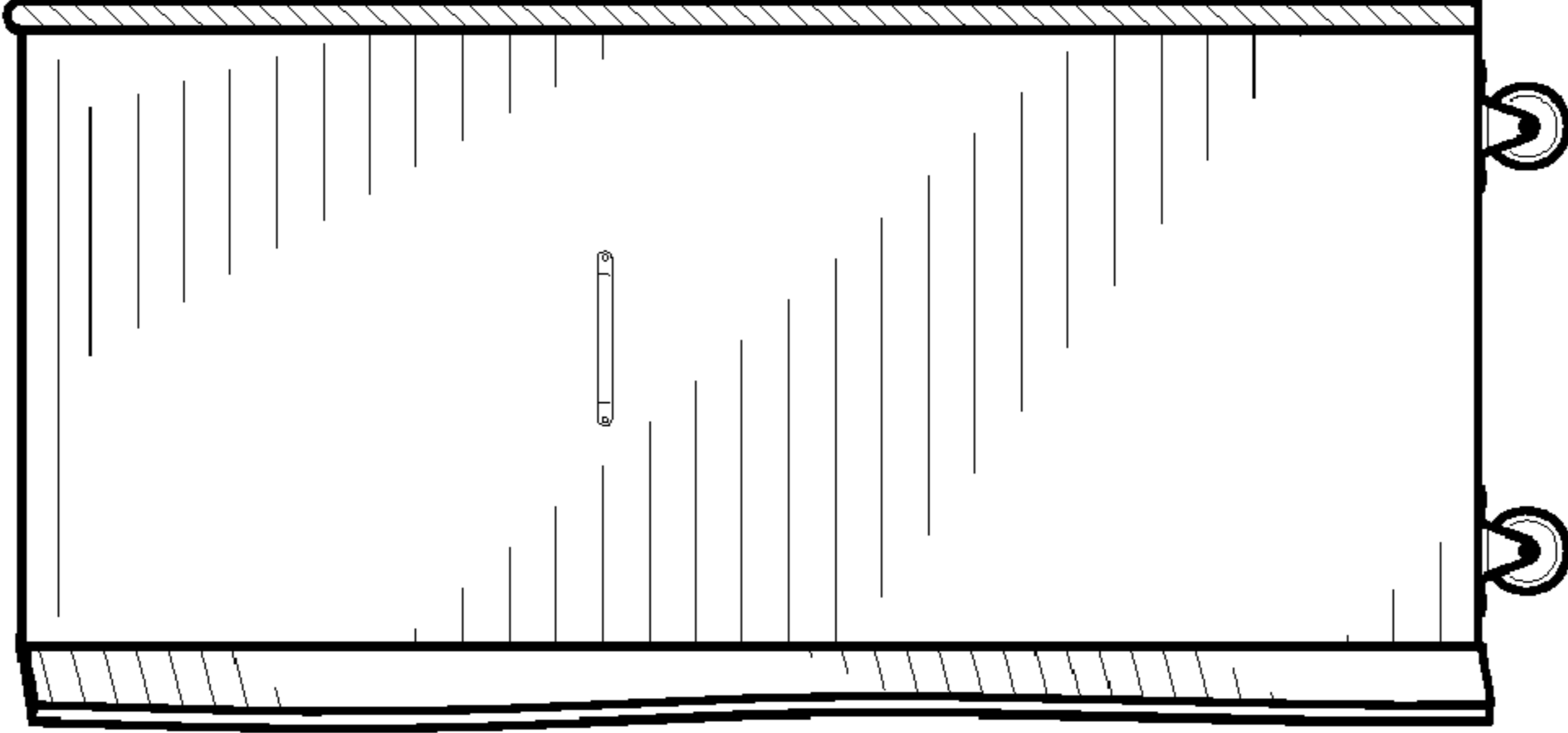

FIG. 10

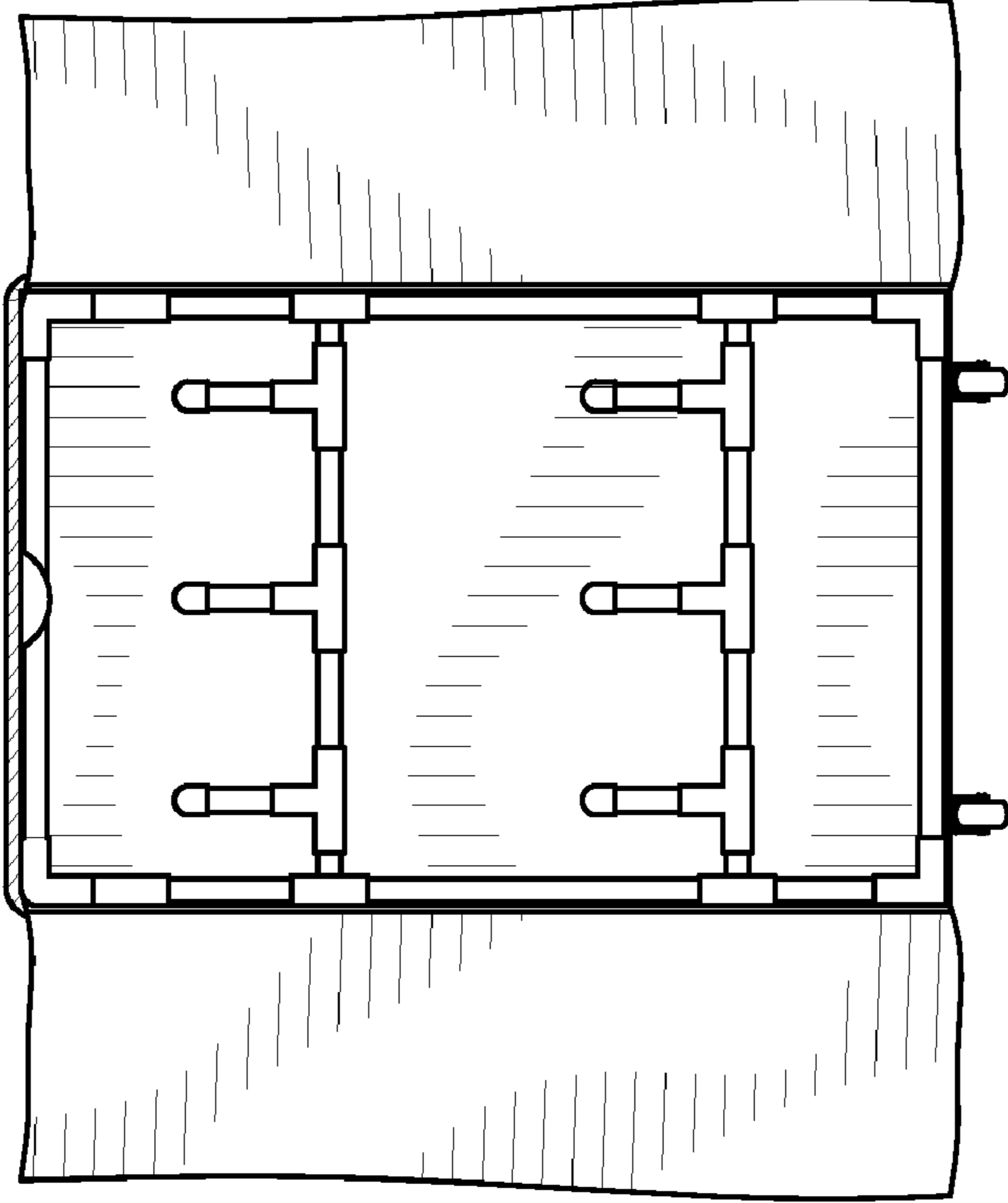

FIG. 9