



US00D668768S

(12) **United States Design Patent**
Payne et al.

(10) **Patent No.:** **US D668,768 S**
(45) **Date of Patent:** **** Oct. 9, 2012**

(54) **FOOT BATH**

(75) Inventors: **Declan Payne**, Tubbercurry (IE);
Raymond Donnelly, Tubbercurry (IE)

(73) Assignee: **Geoffrey Edmund Hooper**, Melton
Mowbray, Leicestershire (GB)

(**) Term: **14 Years**

(21) Appl. No.: **29/394,250**

(22) Filed: **Jun. 15, 2011**

(51) **LOC (9) Cl.** **28-03**

(52) **U.S. Cl.** **D24/204**

(58) **Field of Classification Search** D24/200–205,
D24/212, 213; D28/56, 61; D6/336, 495;
601/6, 15, 64, 157–158, 30–32; 607/44;
4/622, 574.1; D30/158

See application file for complete search history.

(56) **References Cited**

U.S. PATENT DOCUMENTS

D266,700 S * 10/1982 Higgins D24/202
4,565,188 A * 1/1986 Hardie 601/16
D285,003 S * 8/1986 Madl D24/205
D297,863 S * 9/1988 Hardie et al. D24/203
D304,235 S * 10/1989 Chambers D24/204

D317,371 S * 6/1991 Haffner D30/158
D385,359 S * 10/1997 Kelley D24/204
D440,662 S * 4/2001 Ferber D24/200
D441,455 S * 5/2001 Feer et al. D24/200
D444,565 S * 7/2001 Devenish D24/204
7,311,683 B2 * 12/2007 Turell et al. 601/157
D585,995 S * 2/2009 Sinka et al. D24/202
D617,466 S * 6/2010 Edgar D24/204

* cited by examiner

Primary Examiner — David Muller

(74) *Attorney, Agent, or Firm* — King & Schickli, PLLC

(57) **CLAIM**

The ornamental design of a foot bath, as shown and described.

DESCRIPTION

FIG. 1 is a perspective view of a foot bath with a lid being in a closed position;

FIG. 2 is a perspective view of the foot bath with the lid being in an open position;

FIG. 3 is a top view of the foot bath;

FIG. 4 is a front view of the foot bath;

FIG. 5 is a side view of a first side of the foot bath;

FIG. 6 is a side view of a second side of the foot bath; and,

FIG. 7 is a bottom view of the foot bath.

The broken line showing of parts of the drawings is included for the purpose of illustrating use and environment and forms no part of the claimed design.

1 Claim, 7 Drawing Sheets

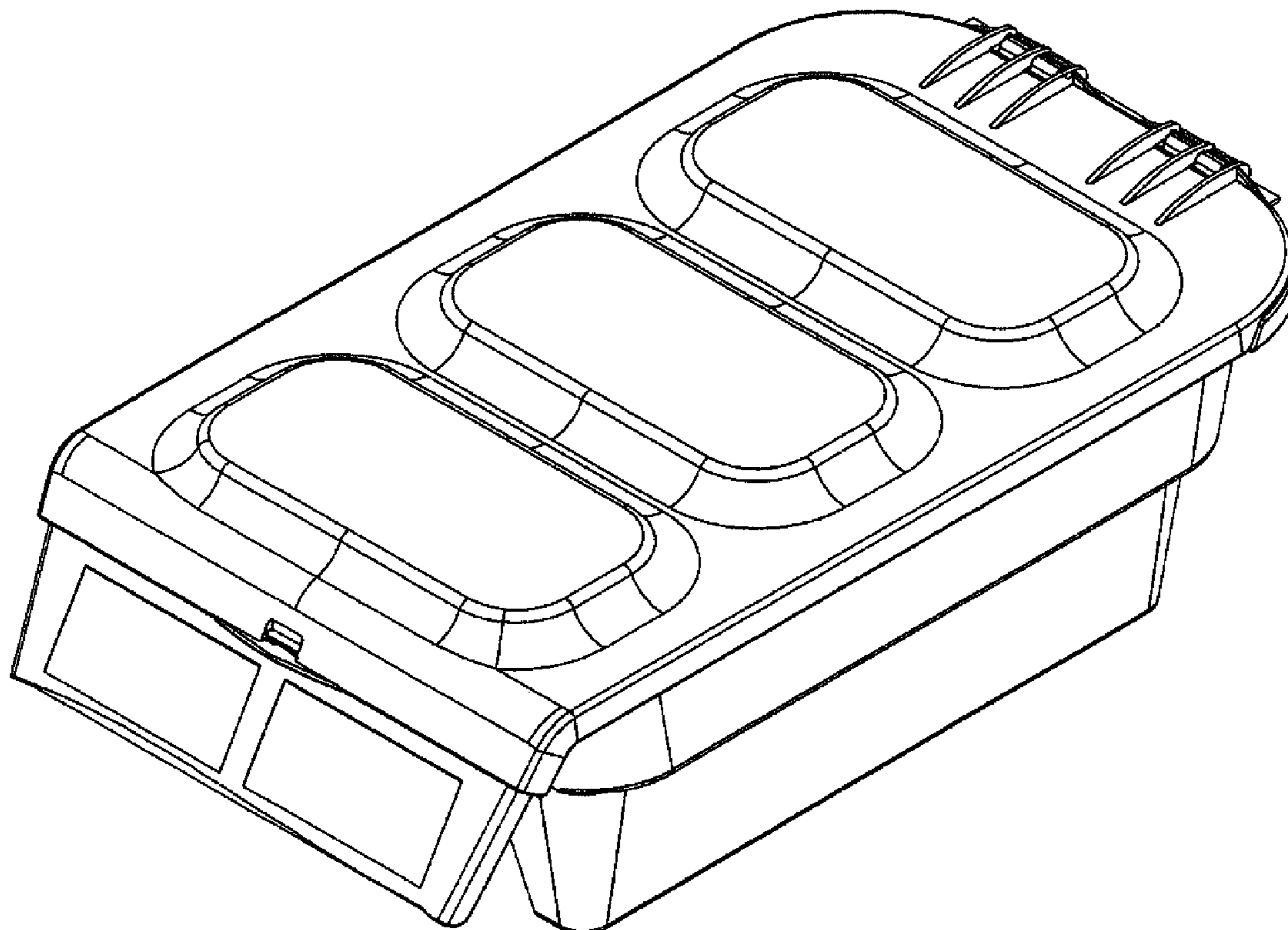

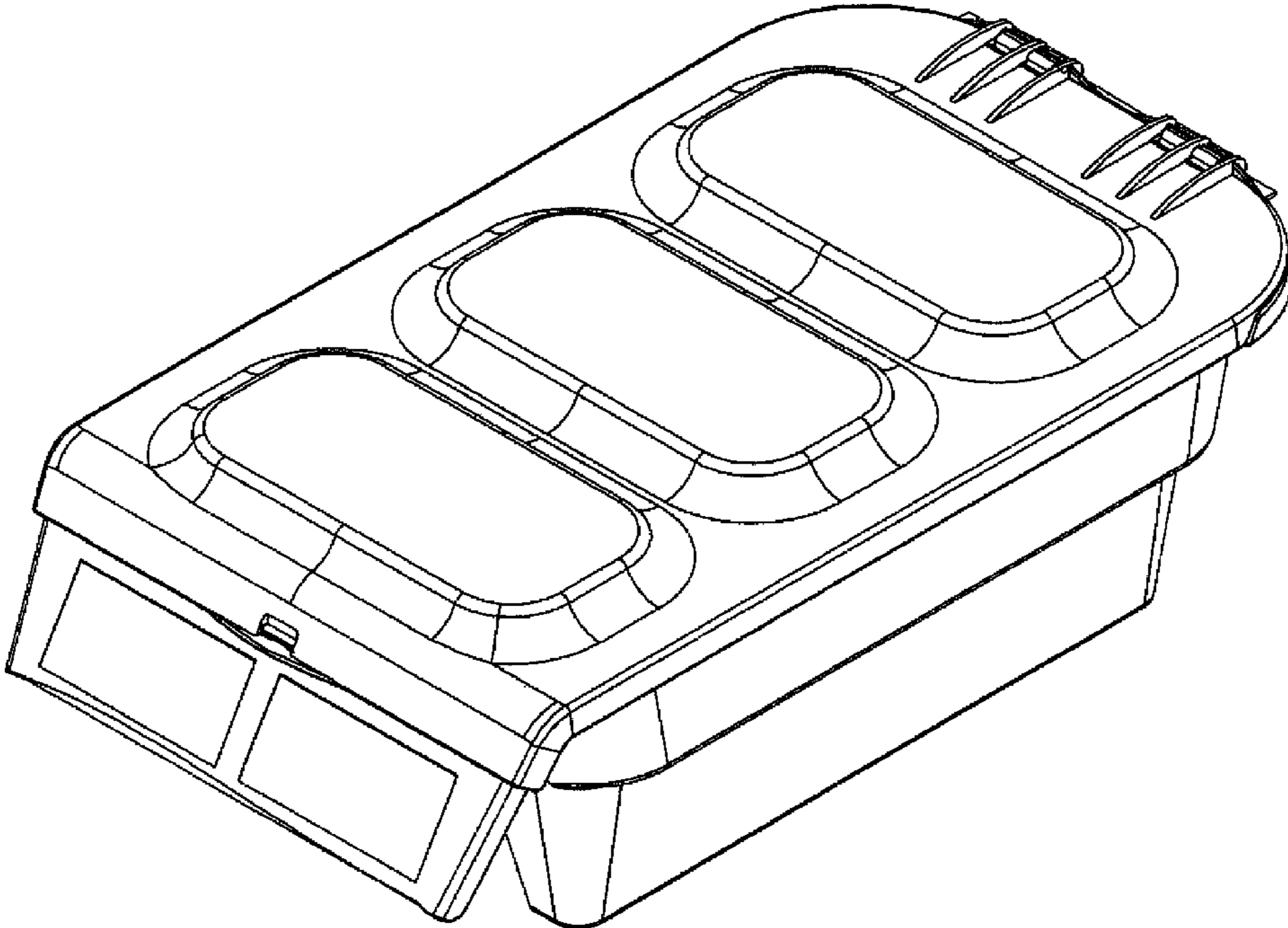

Fig. 1

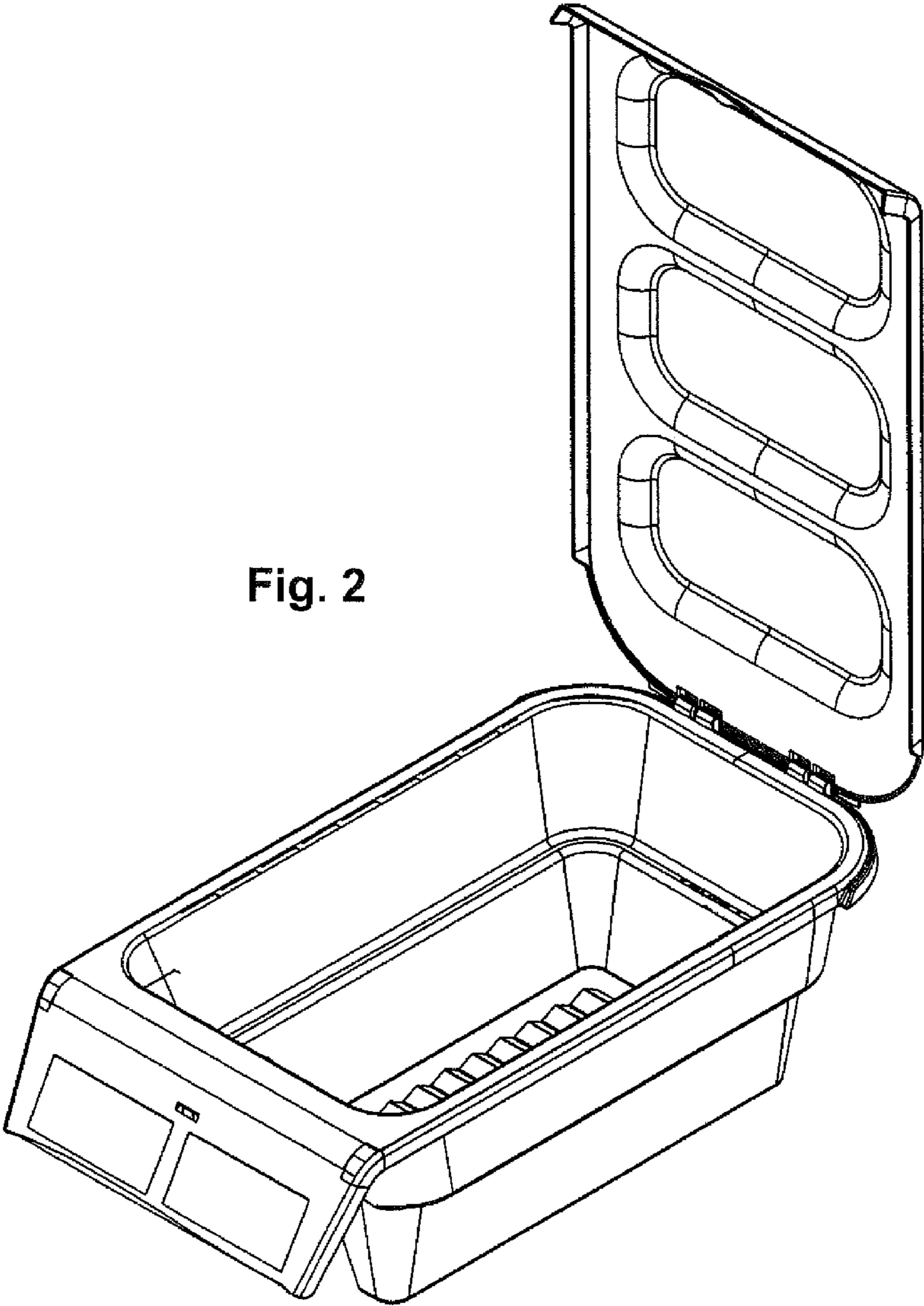
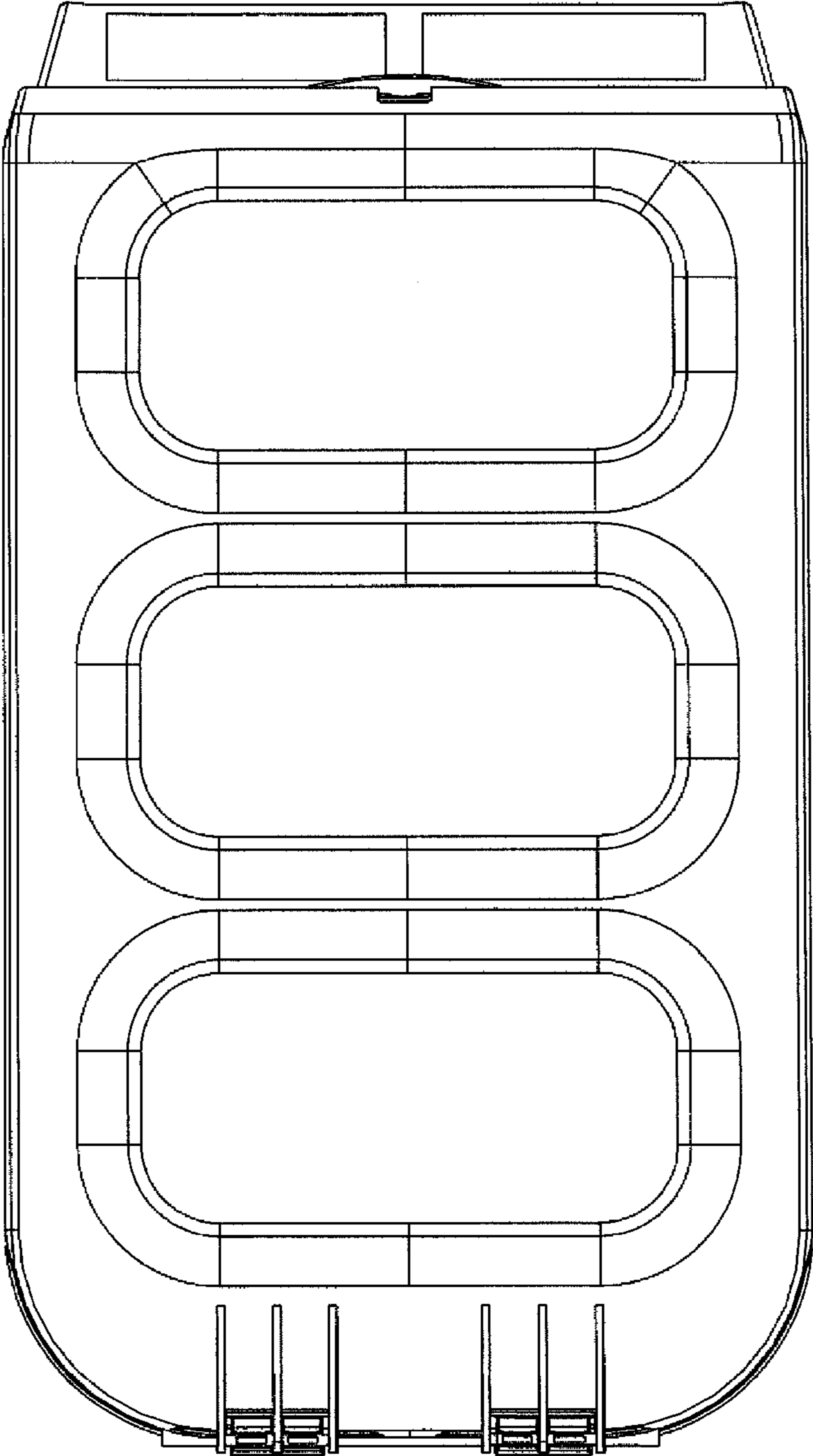

Fig. 2

Fig. 3



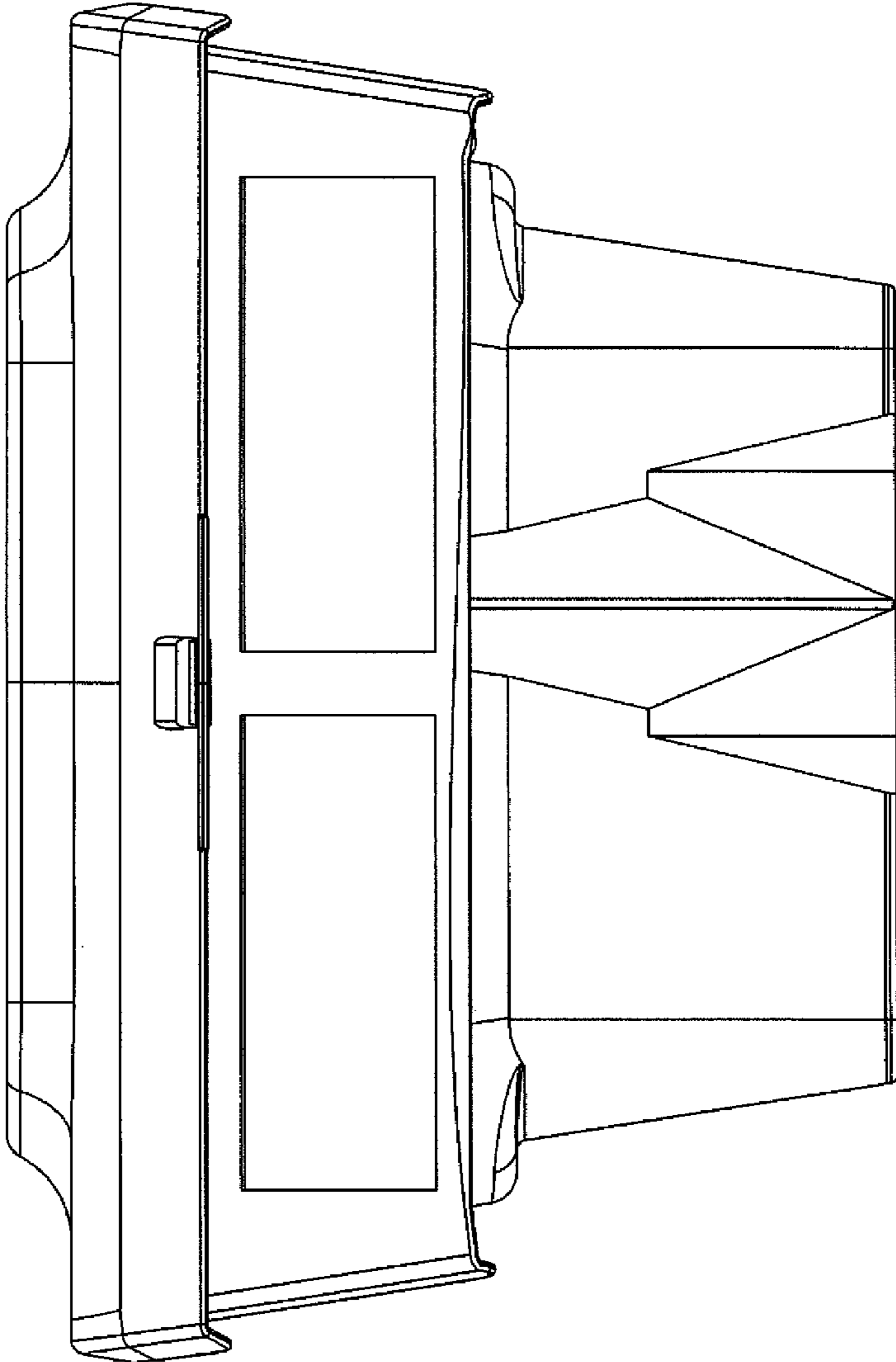

Fig. 4

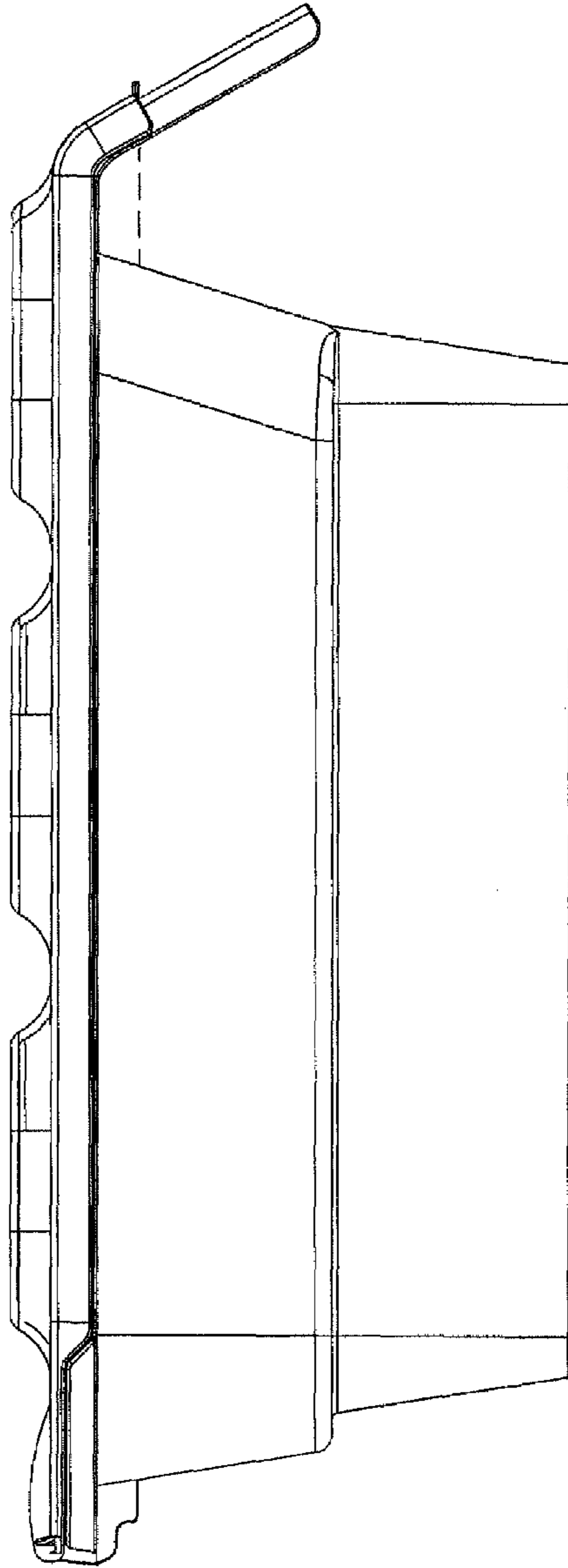

Fig. 5

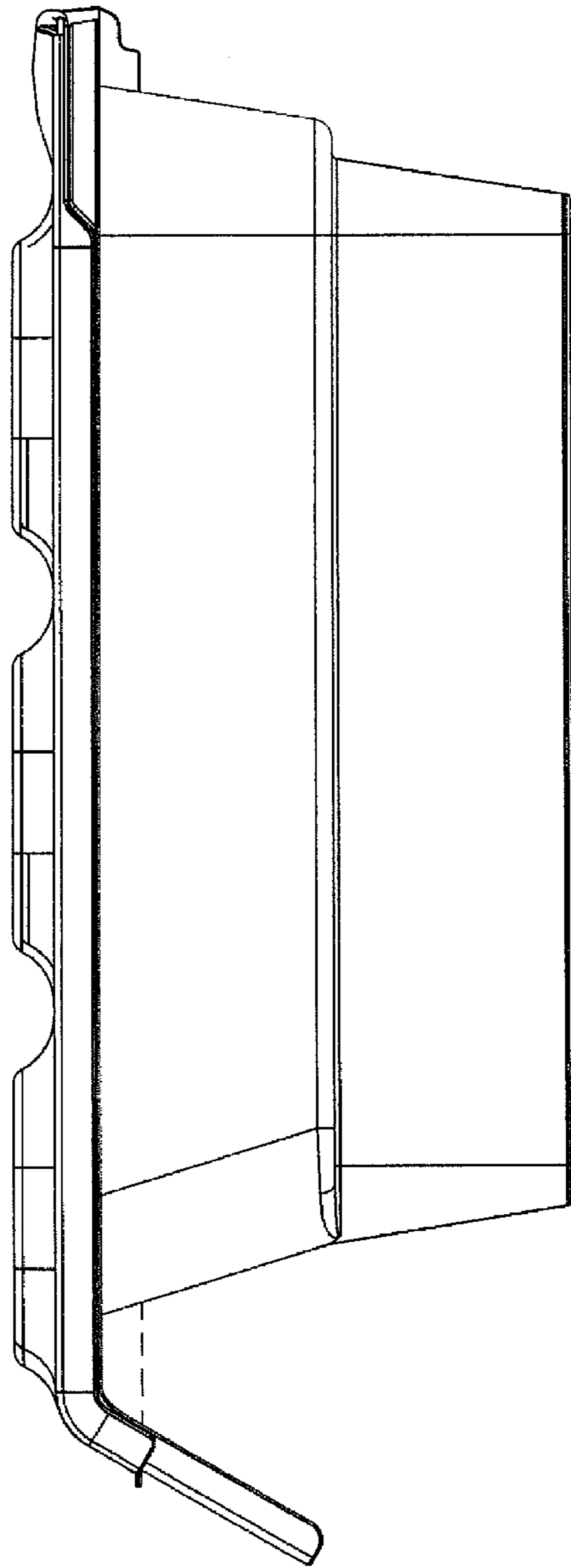

Fig. 6

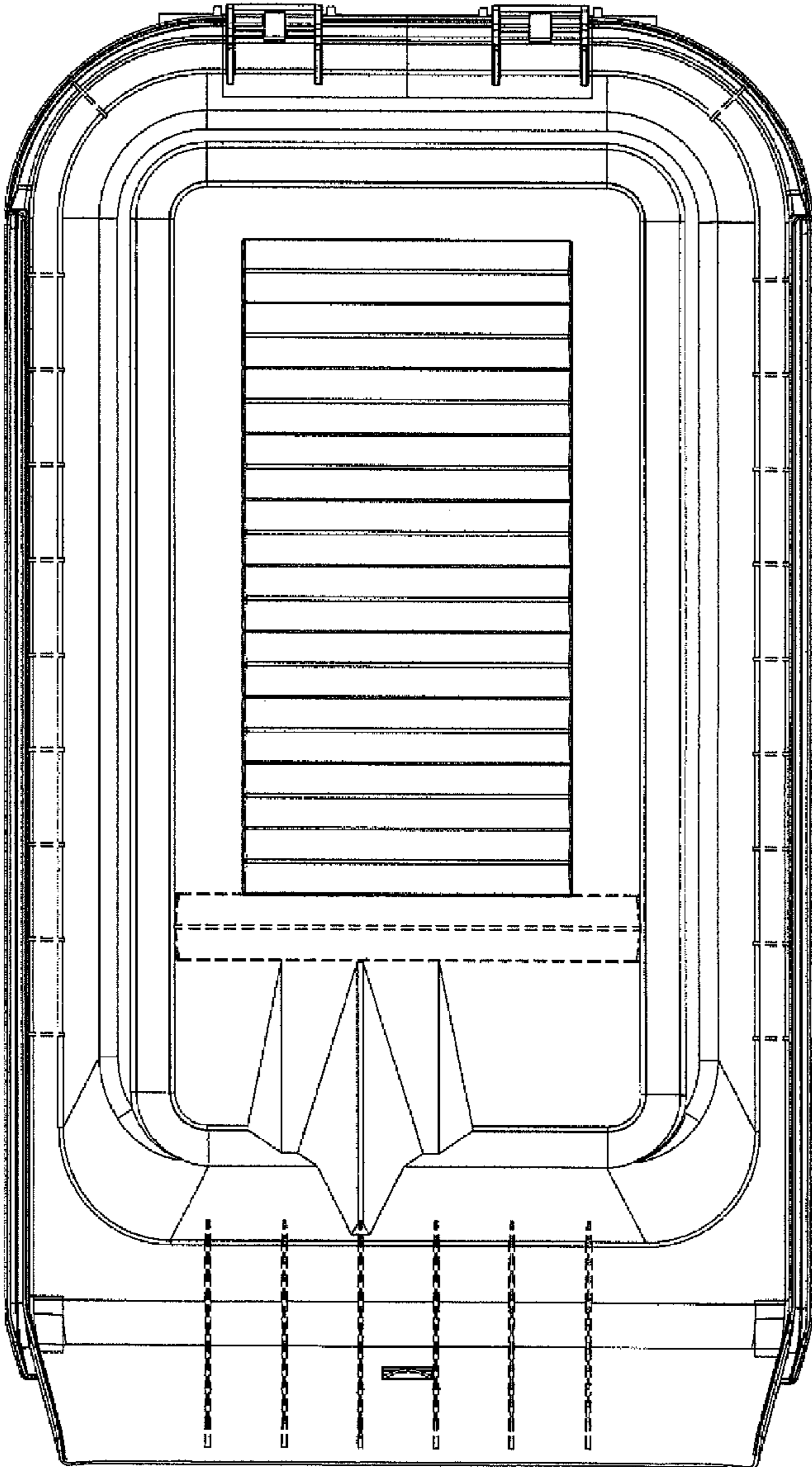

Fig. 7