



US00D668762S

(12) **United States Design Patent**
Makowski et al.

(10) **Patent No.:** **US D668,762 S**

(45) **Date of Patent:** **** Oct. 9, 2012**

(54) **HANDLE FOR MEDICAL DEVICE**

(75) Inventors: **Thomas Makowski**, Messtetten (DE);
Tönis Pilvisto, Küla (EE); **Viktor Josef Wimmer**, Seon (DE)

(73) Assignee: **Karl Storz GmbH & Co. KG**,
Tuttlingen (DE)

(**) Term: **14 Years**

(21) Appl. No.: **29/403,063**

(22) Filed: **Sep. 30, 2011**

(30) **Foreign Application Priority Data**

Mar. 31, 2011 (EM) 001844184-0015

(51) **LOC (9) Cl.** **24-02**

(52) **U.S. Cl.** **D24/138**

(58) **Field of Classification Search** D24/138,
D24/137, 133; 600/101-183

See application file for complete search history.

(56) **References Cited**

U.S. PATENT DOCUMENTS

D486,910	S	*	2/2004	Hayamizu et al.	D24/138
D493,529	S	*	7/2004	Hayamizu et al.	D24/138
D498,846	S	*	11/2004	Hayamizu et al.	D24/138
D638,937	S	*	5/2011	Tanaka	D24/138
2002/0091303	A1	*	7/2002	Ootawara et al.	600/106
2002/0183592	A1	*	12/2002	Suzuki et al.	600/145
2007/0078304	A1	*	4/2007	Shimizu et al.	600/132

2007/0118016	A1	*	5/2007	Frimberger et al.	600/154
2007/0255100	A1	*	11/2007	Barlow et al.	600/114
2008/0119696	A1	*	5/2008	Moriyama	600/146
2009/0023989	A1	*	1/2009	Honda et al.	600/106
2009/0112060	A1	*	4/2009	Sugiyama et al.	600/104
2009/0192357	A1	*	7/2009	Torii	600/149

* cited by examiner

Primary Examiner — Bridget L Eland

(74) *Attorney, Agent, or Firm* — Muncy, Geissler, Olds & Lowe, PLLC

(57) **CLAIM**

The ornamental design for a handle for medical device, as shown and described.

DESCRIPTION

FIG. 1 is a left side perspective view of a handle for medical device according to the present invention;

FIG. 2 is a right side perspective view of the handle for medical device of FIG. 1;

FIG. 3 is a front perspective view of the handle for medical device of FIG. 1;

FIG. 4 is a rear perspective view of the handle for medical device of FIG. 1;

FIG. 5 is a top perspective view of the handle for medical device of FIG. 1;

FIG. 6 is a bottom perspective view of the handle for medical device of FIG. 1; and,

FIG. 7 is a three quarter view of the handle for medical device of FIG. 1.

The dashed lines illustrate environment that does not form a part of the present invention, and no claim is made to the material illustrated with dashed lines.

1 Claim, 7 Drawing Sheets

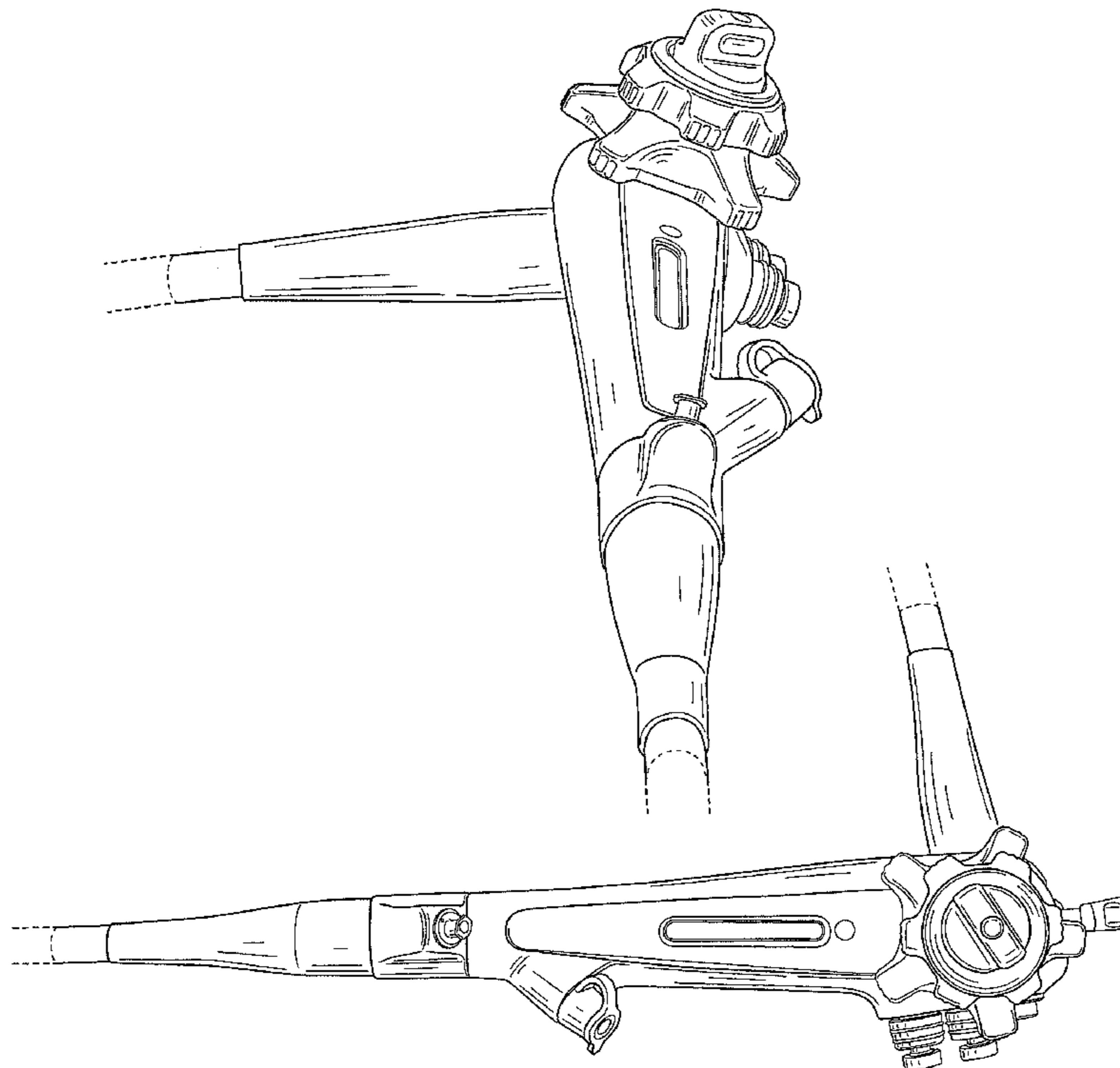

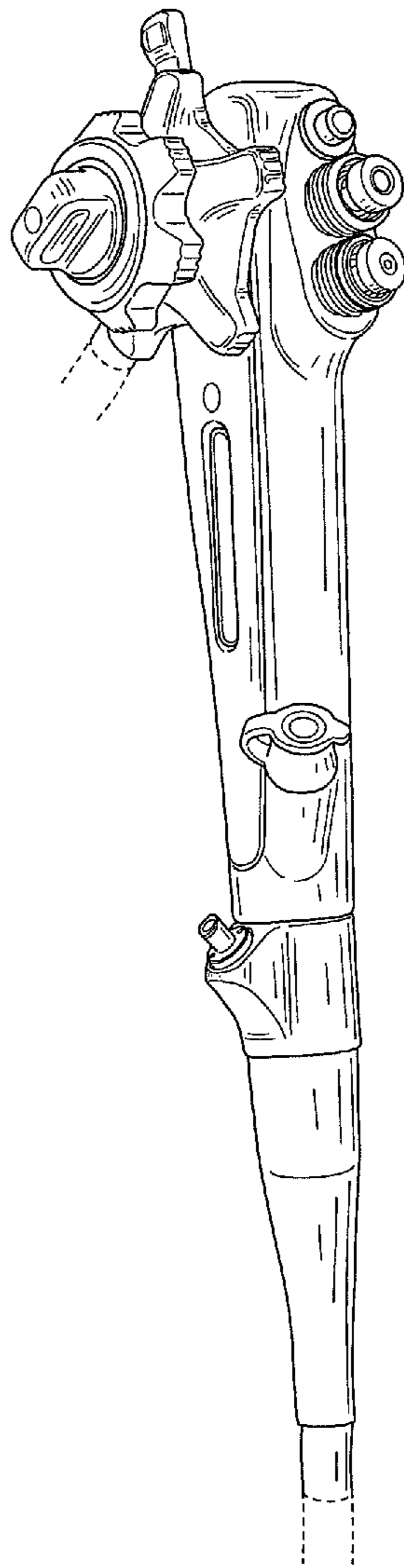

FIG. 1

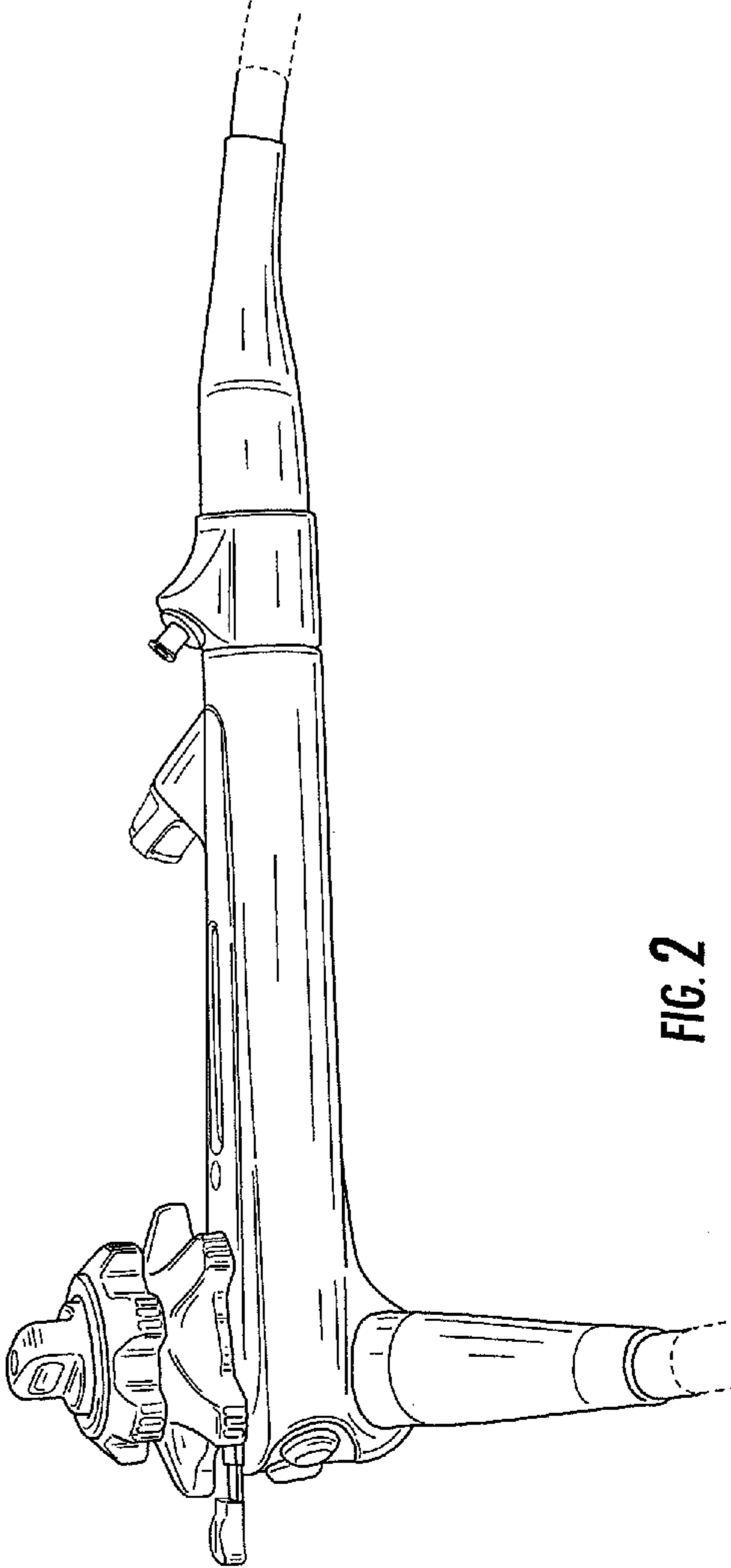

FIG. 2

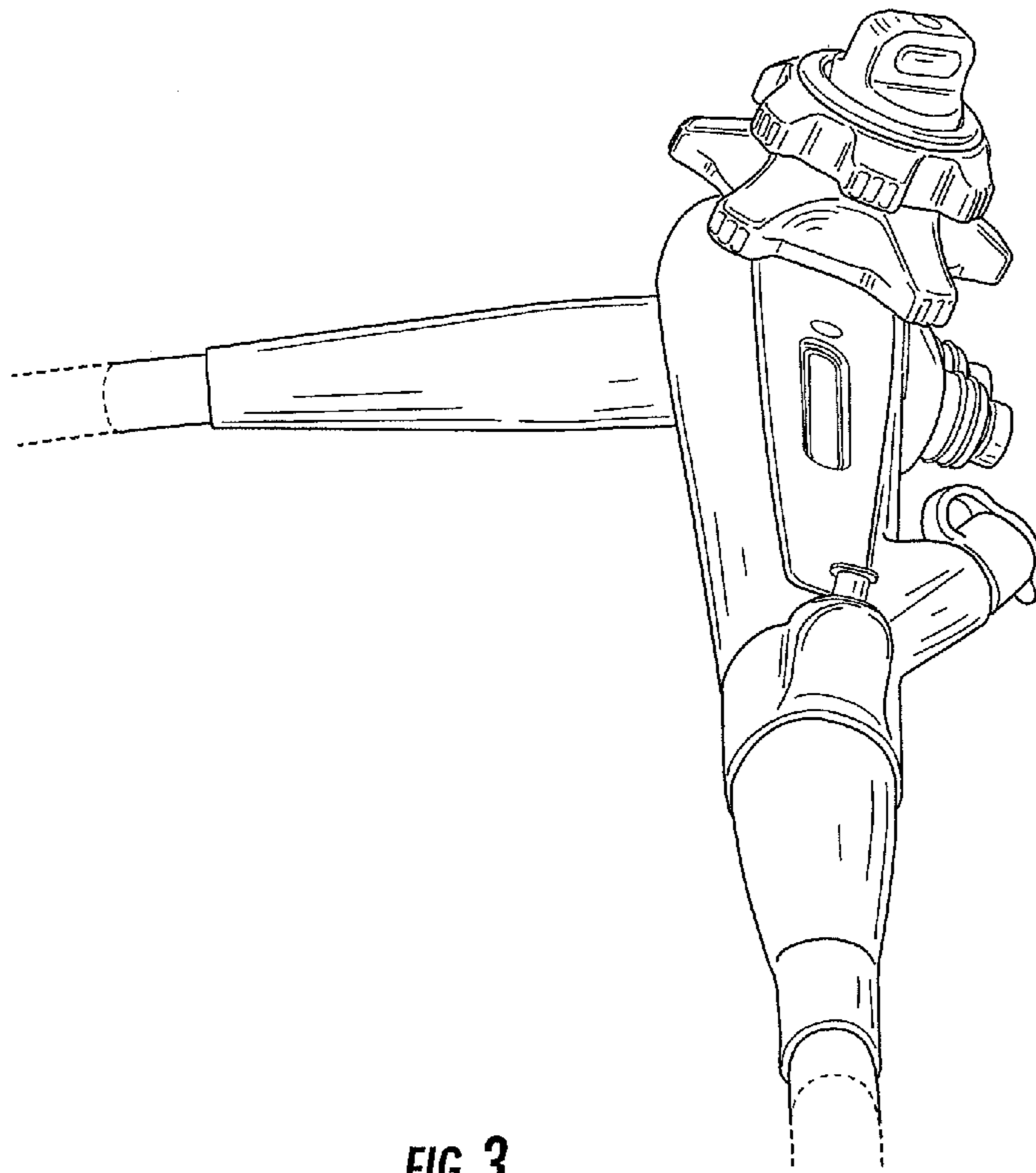

FIG. 3

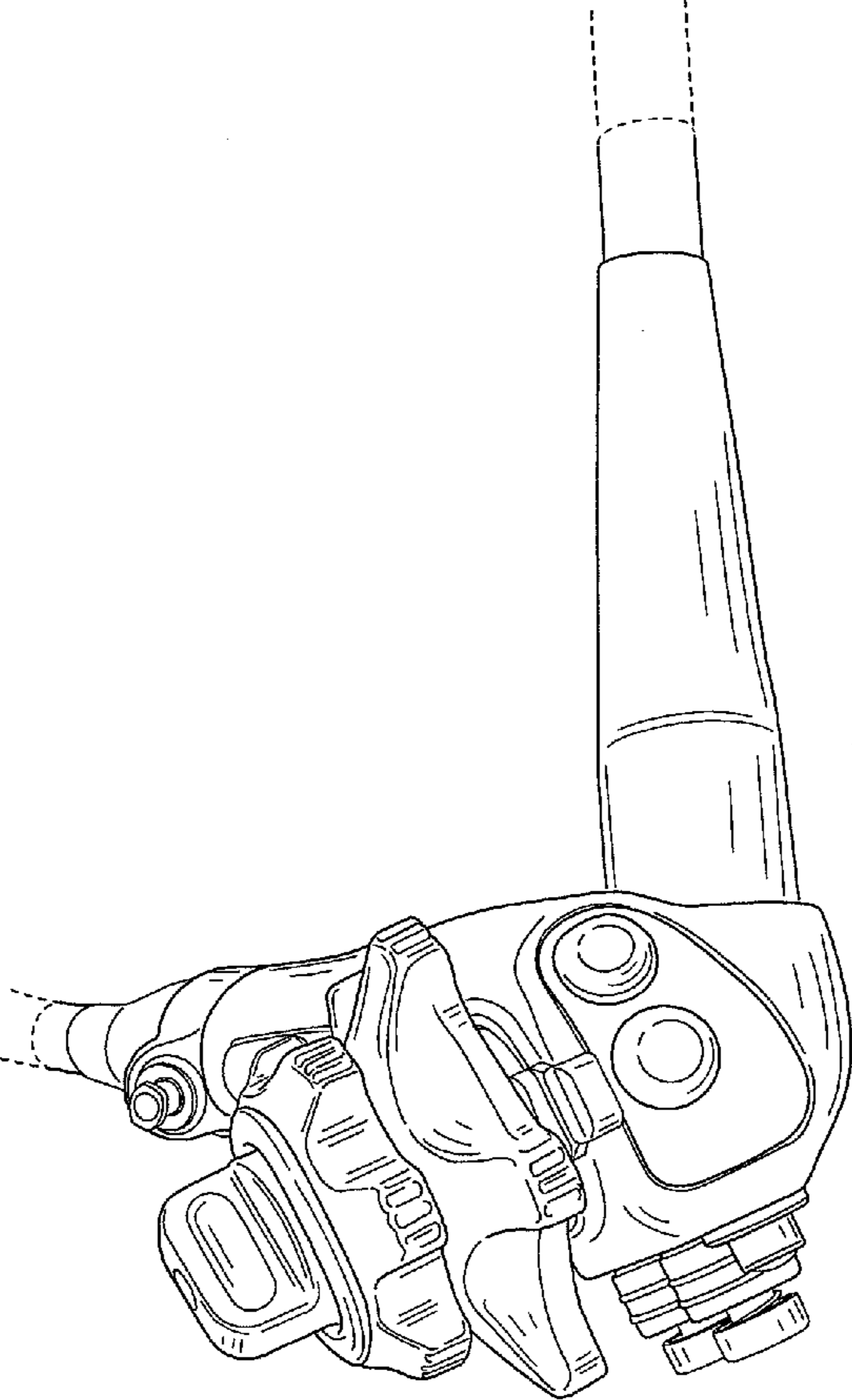

FIG. 4

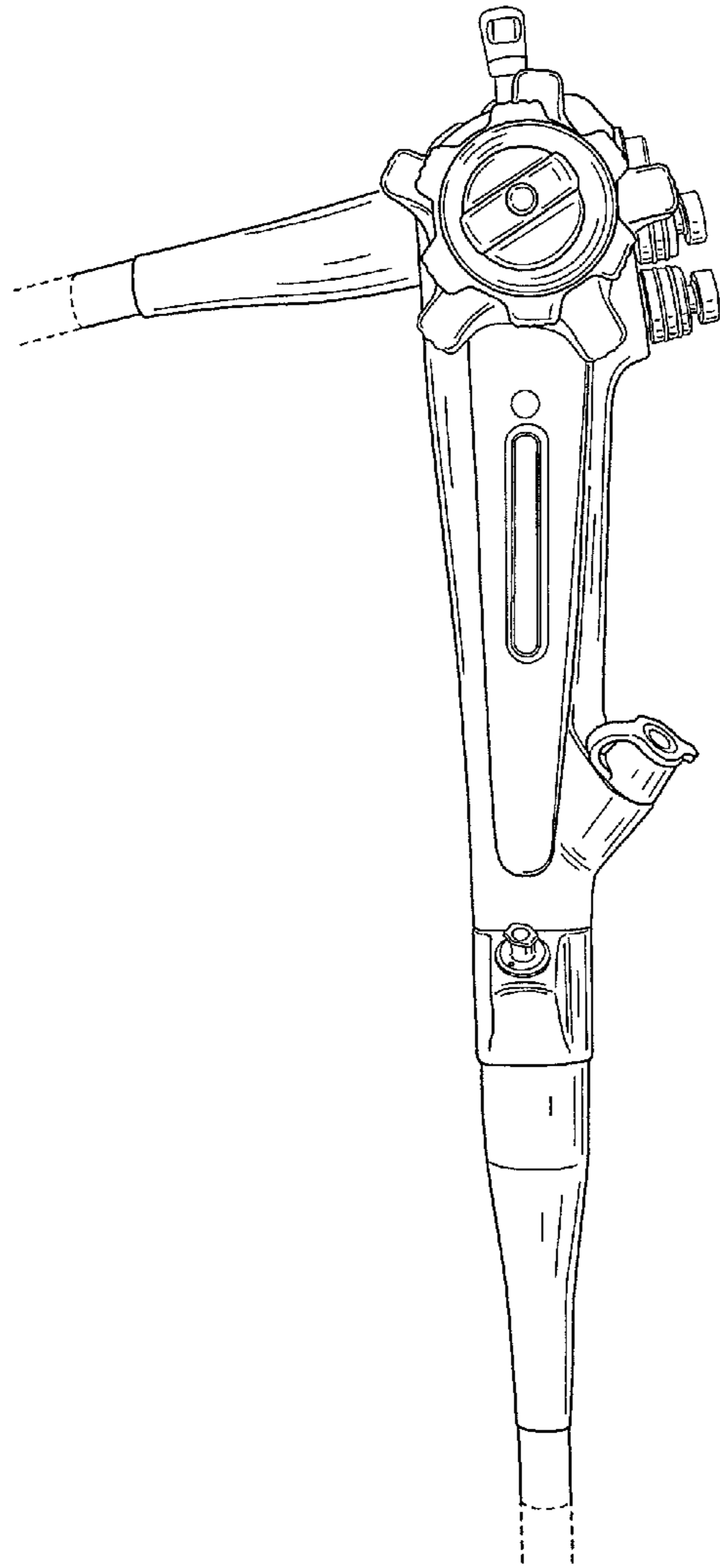

FIG. 5

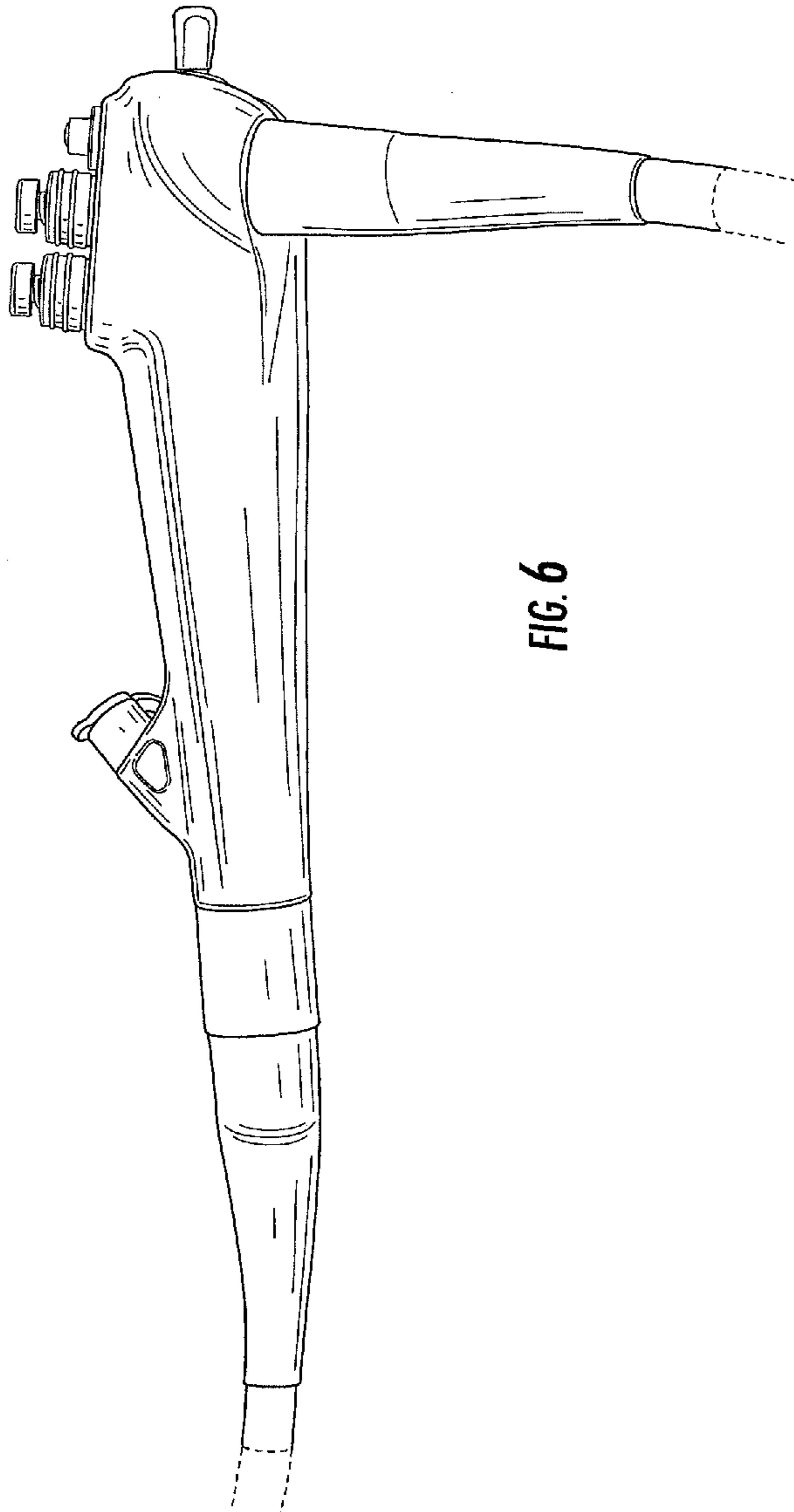

FIG. 6

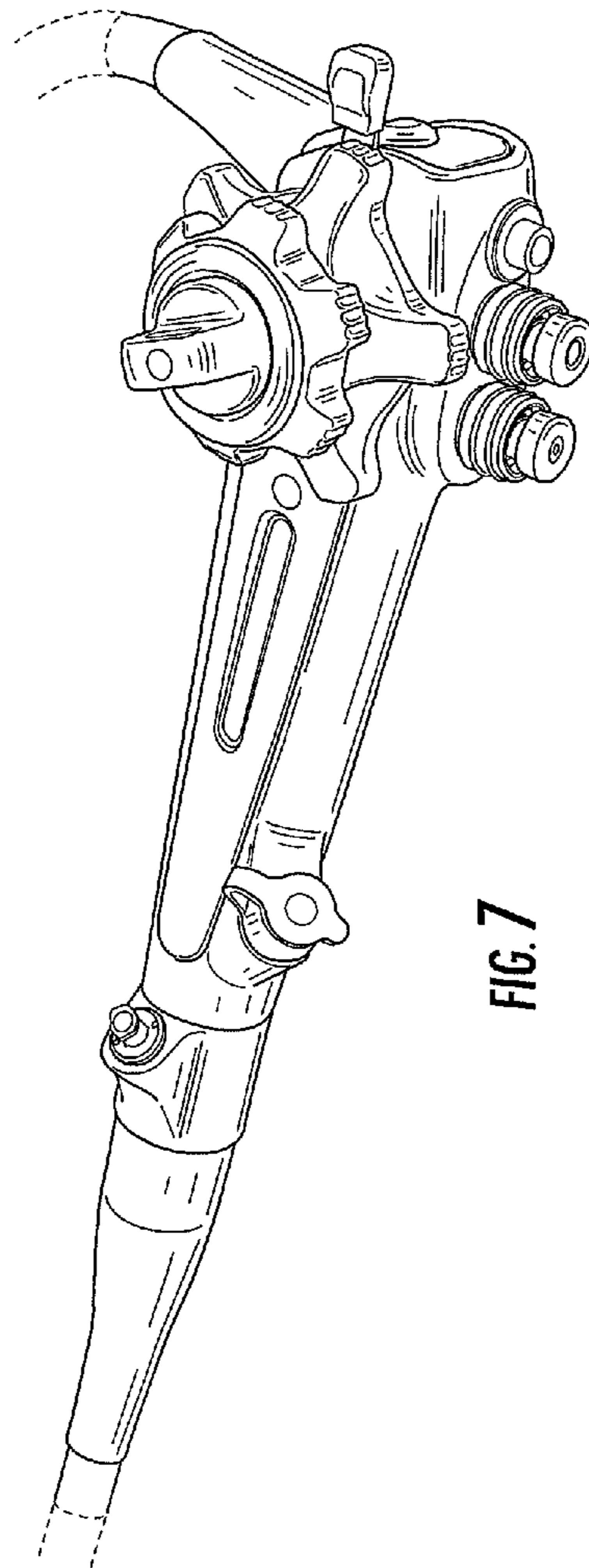

FIG. 7